

**ONKYO**

# TX-NR1030

AV RECEIVER

## Basic Manual

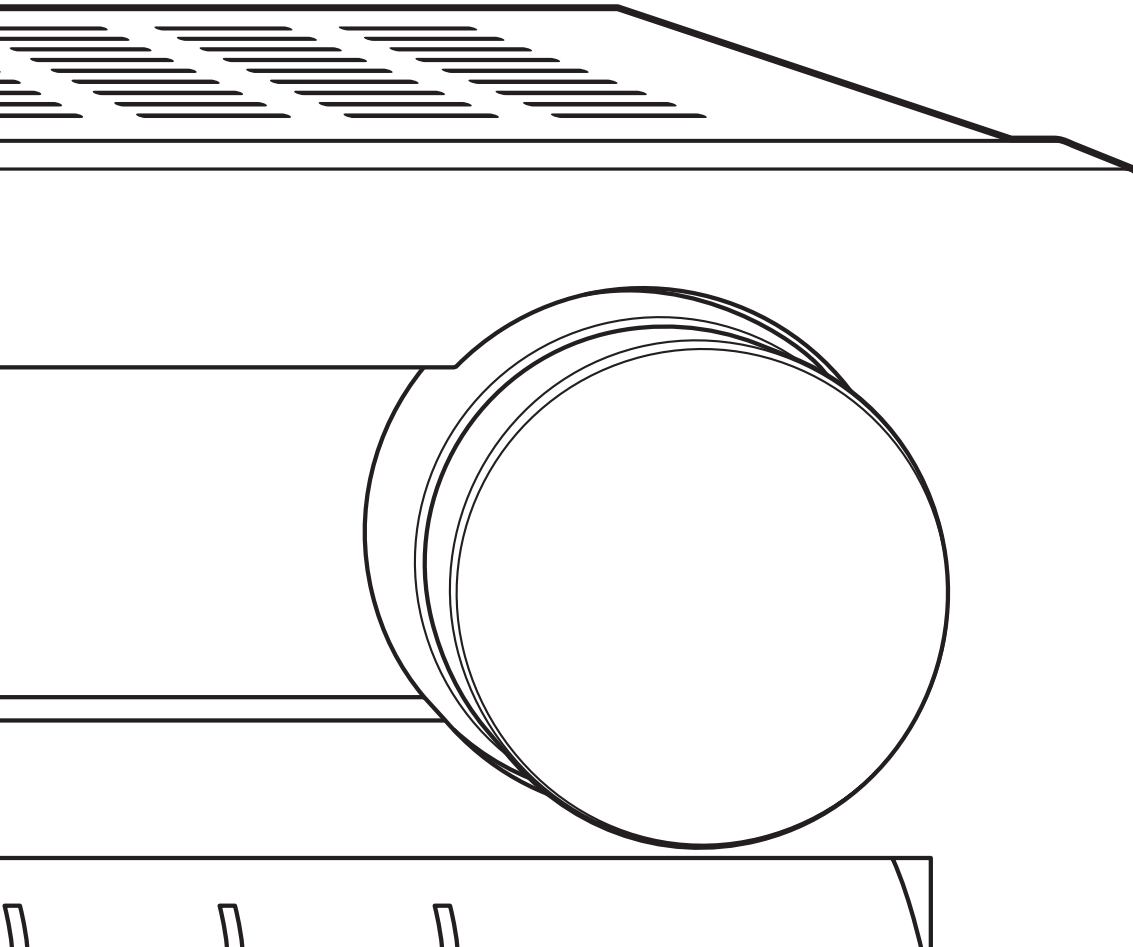

Advanced Manual found here



<http://www.onkyo.com/manual/txnr1030/adv/en.html>

En

# Before Start

## About the Basic Manual

The Basic Manual leads you through the fundamental steps to enjoy the AV Receiver from connections to TV, speaker system and playback components, to necessary functions for playback. As well as that, Basic Manual informs you with the instructions on frequently used functions. Besides, there is another part of the manual called Advanced Manual to inform you with more detailed information, which we have decided to publish on the web from the ecological point of view.

## Advanced Manual







Advanced Manual is always updated with the latest information and its user friendly interface, which does not matter whether you access from PC or Smartphone, helps you to understand more deeply about the AV Receiver. Advanced Manual is consisted of the following chapters.

- Details on AM/FM Playback
- Playing Music Files on a USB Storage Device
- Listening to Internet Radio
- Playing Music with DLNA
- Playing Music Files in a Shared Folder
- Operating Music Files with the Remote Controller
- Listening Mode
- Advanced Settings
- Operating Other Components with the Remote Controller
- Advanced Connection
- Connecting and Operating Onkyo RI Components
- Control Function between the Unit and External Component
- Firmware Update
- Troubleshooting
- Reference Information

## Features

- Equipped with 9 channel amplifier
- Supports playback in Dolby Atmos format which provides 360-degree placement and movement of sounds including overhead sound
- Dolby Surround listening mode expands 2 ch, 5.1 ch or 7.1 ch source to available speaker configurations
- THX Select2 Plus certified
- Incorporates Qdeo™ technology for HDMI video upscaling
- All HDMI jacks support displays of 4K resolution at 60 Hz
- Supports the HDMI Through function which allows transmission from playback devices to the TV in standby state
- Supports HDCP2.2, a strict copy-protection for providing high quality content (HDMI IN3/OUT MAIN only)
- Supports ARC (Audio Return Channel)
- Supports USB storage playback
- Supports variety of network functions such as Internet Radio, DLNA, etc.
- Supports Wi-Fi, Bluetooth and MHL-enabled mobile device
- Bi-Amping capability
- A/V Sync function to correct deviation of audio and video
- Multi-zone function which allows you to play a different source in another room from the main room (Video can also be played in Zone 2)
- 32 bit DSP (Digital Signal Processor) with excellent calculation performance
- Music Optimizer™ for Compressed Digital Music files
- Phase Matching Bass System
- Automatic speaker setup available using supplied calibrated microphone (AccuEQ Room Calibration)
- Supports playback of MP3, FLAC, WAV, Ogg Vorbis, Apple Lossless, DSD via network and USB storage device (the supported formats will differ depending on the use environment)
- ISF (Imaging Science Foundation) Video Calibration

## Supplied Accessories

-  Indoor FM antenna --- (1)
-  AM loop antenna --- (1)
-  Color labels for speaker cable --- (1)
-  Remote controller (RC-884M) --- (1)  
Batteries (AA/R6) --- (2)
-  Power cord --- (1)
-  Speaker setup microphone --- (1)

\* The number in parenthesis indicates the quantity. On packaging, the letter at the end of the product name indicates the color.

## How to use the remote controller

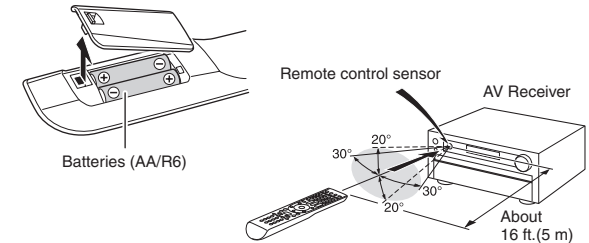

- \* If you do not use the remote controller for a long time, remove the batteries to prevent leakage.
- \* Note that keeping consumed batteries inside may cause corrosion resulting in damage of the remote controller.



Advanced Manual found here  
<http://www.onkyo.com/manual/txnr1030/adv/en.html>

# Step 1: Connections

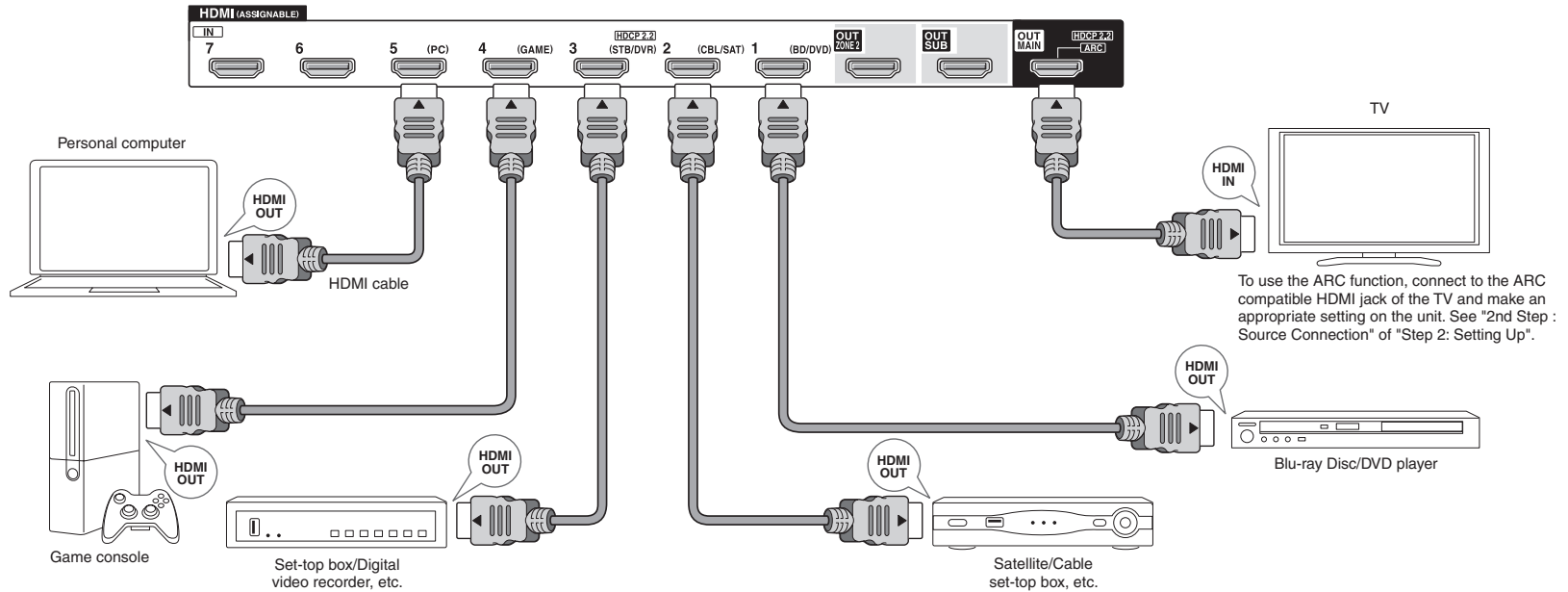

## 1 Connecting the TV and players

**Important:** The power cord must be connected only after all other connections are completed.

### HDMI Cable Connection

The unit has many HDMI jacks on its rear panel and each of them corresponds to an input selector button of the same name on the front panel. For example, a Blu-ray Disc player will be connected to the IN 1 jack and the BD/DVD button on the front panel will be used to listen to the playback sound (if the player is CEC compliant, input will be switched automatically). If you add another Blu-ray Disc player, you can use any other jack than IN 1. It is possible to change assignment of the input jacks and input selector buttons.

For how to make settings, see the Advanced Manual.

To connect the TV and the unit, connect the HDMI OUT MAIN jack of the unit and the HDMI IN jack of the TV using an HDMI cable. With this connection, it becomes possible to display the setting screen of the unit on the TV or transmit video/ audio signals from the player to the TV. If your TV supports ARC (Audio Return Channel), it is possible to play the TV sound with the AV receiver's speakers with this connection only. If your TV does not support ARC, you need, in addition to the HDMI OUT MAIN jack connection, a digital optical cable connection between the digital audio out optical jack of the TV and the DIGITAL IN OPTICAL jack of the unit or an analog audio (RCA) cable connection between the audio output jack of the TV and the TV/CD analog audio input jack of the unit.

### ● Audio connection with a TV not supporting ARC

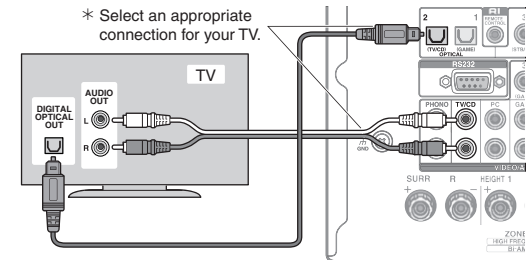

Another TV can be connected to the HDMI OUT SUB jack. In this case, press MONITOR OUT on the main unit several times to display "SUB" or "MAIN+SUB" and select the output method. You can also enjoy using Zone function with the HDMI OUT ZONE 2 jack. For details, see the section 6 "Using the multi-zone function" of "Step 3: Playing Back".

The unit supports the HDMI Through function that allows transmission from players to the TV even if the unit is in standby. You have to modify the settings to enable the input selection link with CEC compliant device, connection with ARC compatible TV, and HDMI Through function. See "2nd Step : Source Connection" of "Step 2: Setting Up".

- To enjoy HDCP2.2 protected video, connect the player to the IN3 jack and the TV to the HDMI OUT MAIN jack of the unit. Your player and TV need to support HDCP2.2.
- To play 4K or 1080p video, use the high speed HDMI cable.
- It is possible to send video and audio of an MHL-enabled mobile device by connecting the MHL-enabled mobile device to the AUX INPUT HDMI/MHL jacks on the front panel.

### Connecting Components without HDMI

If your AV component does not have HDMI jack, use an available jack of your component for cable connection with this unit. Just as the HDMI jacks, other jacks on this unit have a preassigned input selector button on the front panel. See the name of the input selector button shown with the jack when connecting the device.

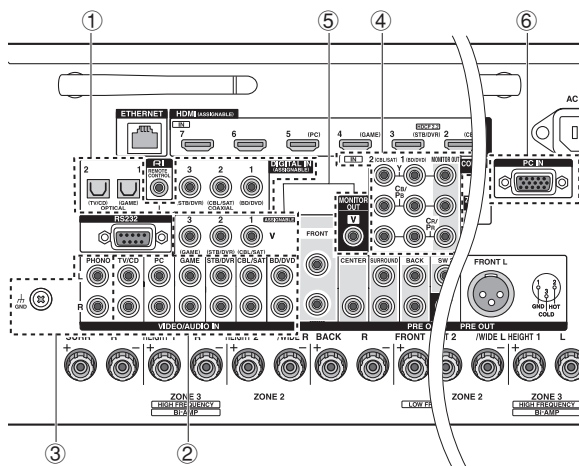

### Audio signal connection

- 1 **Digital connection:** Use a digital optical cable (OPTICAL) or digital coaxial cable (COAXIAL) for connection with a player.

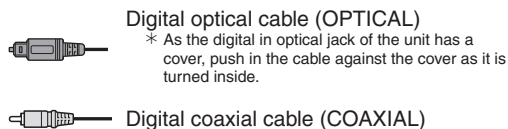

- 2 **Analog connection:** Use an analog audio (RCA) cable for connection with a player.

To enjoy multi-zone playback of audio of a CD player or such other player without HDMI output jack, you need to use the analog audio (RCA) cable to connect the corresponding jacks of the player and this unit. For details on the multi-zone function, see the section 6 "Using the multi-zone function" of "Step 3: Playing Back".

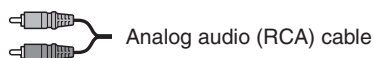

- 3 **Connection with turntable:** If it uses an MM type cartridge and does not have a built-in audio equalizer, connect it to the 3 PHONO jack. If the connected turntable has a built-in audio equalizer, connect it to the 2 TV/CD jack.

- \* If it uses an MC type cartridge, install an audio equalizer compatible with MC type cartridge between the unit and the turntable by connecting it to the 2 TV/CD jack. For details, refer to the turntable's instruction manual.
- \* If the turntable has a ground wire, connect it to the GND terminal of this unit. If connecting the ground wire increases noise, disconnect it.

### Video signal connection

The unit has a video upconversion function. For details, see the section on the right.

- 4 Use a component video cable to connect a TV with component video input jacks and a player with component video output jacks.

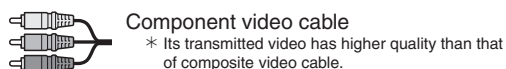

- 5 Use a composite video cable to connect a TV with composite video input jack or a player with composite video output jack.



- 6 Use an analog RGB cable to connect the unit with a PC.



- \* Video signals from the PC connected with the PC IN port will be output only to a TV connected with the HDMI OUT MAIN/SUB/ZONE 2 jack.

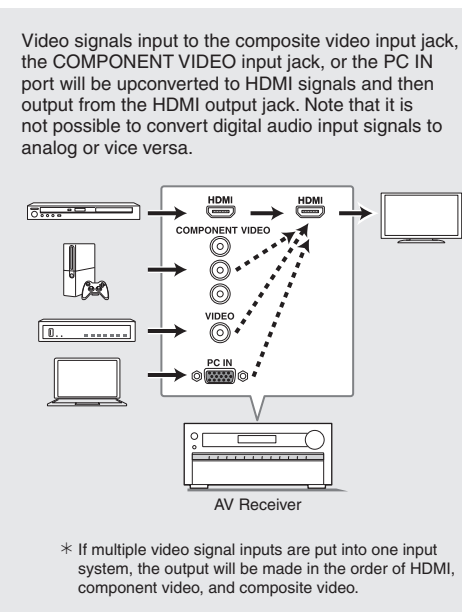

- \* If multiple video signal inputs are put into one input system, the output will be made in the order of HDMI, component video, and composite video.

## 2 Connecting speakers

### Speaker layout

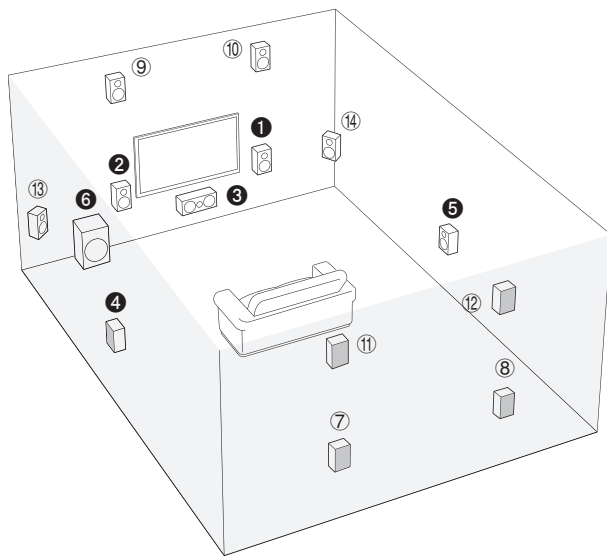

To enjoy the Dolby Atmos listening mode, Height 1 speakers or surround back speakers need to be installed.

- ① ② Front speakers
  - ③ Center speaker
  - ④ ⑤ Surround speakers
  - ⑥ Subwoofer
  - ⑦ ⑧ Surround back speakers
  - ⑨ ⑩ Height 1 speakers (Front High)
  - ⑪ ⑫ Height 2 speakers (Rear High)
  - ⑬ ⑭ Wide speakers
- ⑪ ⑫ and ⑬ ⑭ share the same speaker terminals. Select either of the groups.
  - To use the multi-zone function, see the section 6 "Using the multi-zone function" of "Step 3: Playing Back".

**5.1 ch:** Connect the speakers

① ② ③ ④ ⑤ ⑥ to the unit. ① ② output front stereo sound. ③ outputs center sounds such as dialogs and vocals. ④ ⑤ create back sound field. ⑥ reproduces bass sounds and creates rich sound field. Up to four subwoofers can be connected to the unit.

**Surround back speakers:** Placing ⑦ ⑧ speakers allows playback in 7.1 ch configuration that improves sense of envelopment created by back sound field. It also improves seamlessness of back sounds and provides more natural sound experiences in the sound field.

**Height speakers 1 and 2:** Placing ⑨ ⑩ or ⑪ ⑫ speakers produce surround effects on a height plane.

- To enjoy the Dolby Atmos listening mode, Height 1 speakers or surround

- back speakers need to be installed.
- Although Height 1 speakers can enhance surround effects, we recommend you to add Height 2 speakers in order to ensure full effects.
- Install Height speakers such as Front High and Rear High speakers on the upper part of the front or rear wall. There are other types of Height speakers.

**Wide speakers:** Placing ⑬ ⑭ speakers makes the front sound field even wider. It also give smoother transitions between front and back surround sounds.

The power amplifier of this unit is designed for 9 ch configuration. Therefore, ⑦ ⑧ speakers cannot be used together with ⑪ ⑫ (or ⑬ ⑭) speakers during playback. When both groups are connected, you can switch speakers to be used on the Quick Setup menu that appears when you press Q SETUP on the remote controller (Speaker Layout function).

- For details on the Speaker Layout function, see the section 5 "Using Quick Setup menu" of "Step 3: Playing Back".
- 11 ch playback is possible by connecting an external power amplifier to this unit. See the Advanced Manual for information on how to connect the external amplifier.

### Height speakers arrangements (Dolby Atmos)

There are several types of Height speakers other than those mentioned in the previous section. See the next section "Combination patterns of Height speakers 1 and 2" and select the combination pattern from those specified for Height speakers 1 and Height speakers 2.

- This unit performs optimal sound field processing for the type of Height speakers 1 and 2 which is registered in initial settings (with setup wizard) according to an actual speaker layout. Note that the optimal effect cannot be achieved if you

- place Height speakers in a combination pattern other than those specified.
- Dolby recommends to place the speakers as described on "Installing speakers in ceiling" to obtain the best Dolby Atmos effect.

### Using Dolby Enabled Speakers

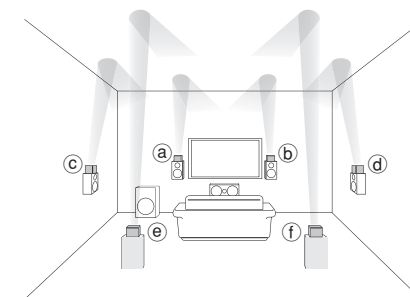

- ① ② Dolby Enabled Speaker (Front)
- ③ ④ Dolby Enabled Speaker (Surround)
- ⑤ ⑥ Dolby Enabled Speaker (Back)

A Dolby Enabled Speaker is specially designed to be used as a Height speaker. There two types of Dolby Enabled Speakers, the one is to be placed on the top board of other speakers such as front speakers and surround speakers, and the other is integrated type with the normal speakers. Dolby Enabled Speakers designed with their output facing toward the ceiling to create an elevated audio effect in the Dolby Atmos and Dolby Surround listening modes by providing sounds echoing off the ceiling.

### Installing speakers in ceiling

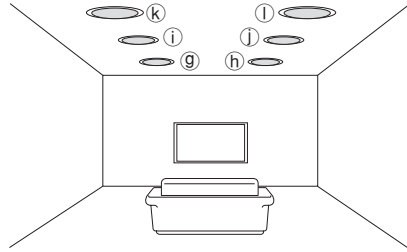

- g h Top Front
- i l Top Middle
- k l Top Rear

Ceiling speakers, etc. are used for maximizing effects in Dolby Atmos or Dolby Surround listening mode. Install Top Front speakers midway between the position just above the listening position and the position just above the front speakers. Install Top Middle speakers just above the listening position. Install Top Rear speakers midway between the position just above the listening position and the position just above the surround back speakers.

### Combination patterns for Height speakers 1 and 2

Dolby recommends the following combination pattern to obtain the best effect of Dolby Atmos and Dolby Surround listening modes

- Pair 1 : Top Middle
- Pair 2 : Top Front / Top Rear

The following are the patterns of Height speakers 2 that can be selected according to the type of Height speakers 1.

#### Height speakers1 : Front High

Height speakers 2: Not Use/Top Middle/Rear High/Dolby Enabled Speaker (Surround)/Dolby Enabled Speaker (Back)

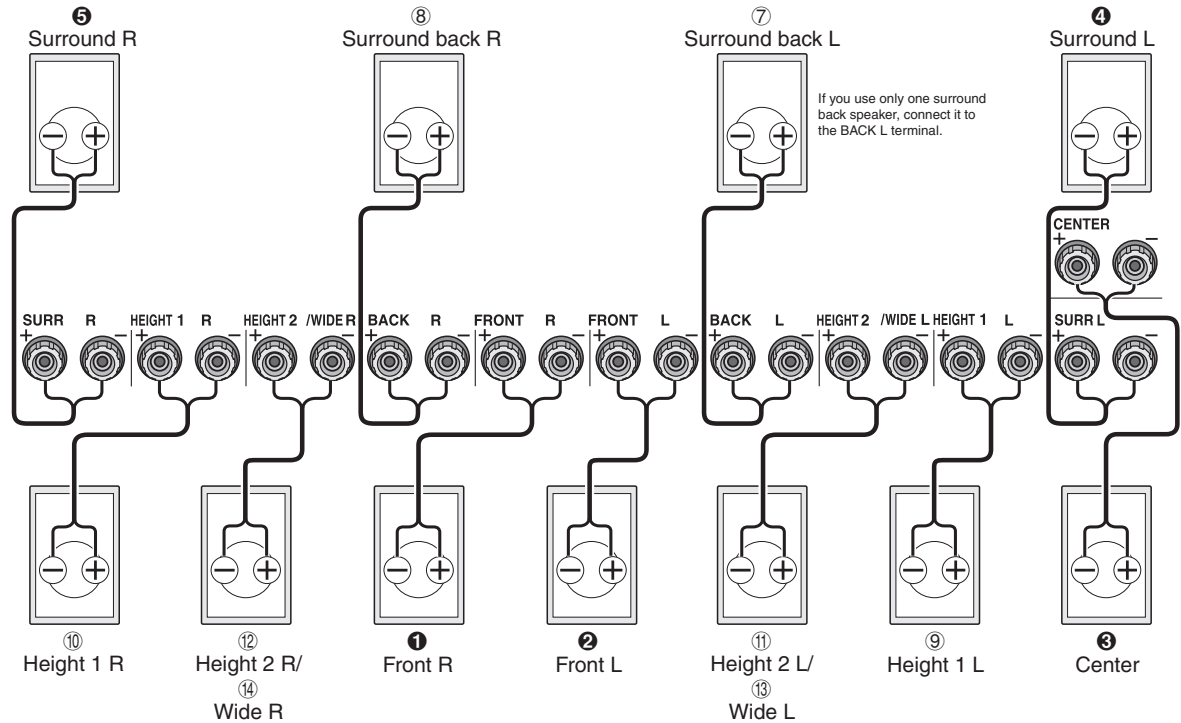

Height speakers 1 : **Top Front**

Height speakers 2: Not Use/Top Rear

Height speakers1 : **Top Middle**

Height speakers 2 cannot be used.

Height speakers 1 : **Dolby Enabled Speaker (Front)**

Height speakers 2: Not Use/Dolby Enabled Speaker (Surround)/Dolby Enabled Speaker (Back)

Height speakers 1 : **Dolby Enabled Speaker (Surround)**

Height speakers 2 cannot be used.

Height speakers1 : **Dolby Enabled Speaker (Back)**

Height speakers 2 cannot be used.

- When front speakers are bi-amp connected, you can select a pattern for Height speakers 2 from the following options. Not Use/Front High/Top Front/Top Middle/Dolby Enabled Speaker (Front)/Dolby Enabled Speaker (Surround)/Dolby Enabled Speaker (Back)

### Instructions on how to connect speakers

**Important:** Connect speakers with 4 Ω to 16 Ω impedance. You have to change the setting if any of the speakers have 4 Ω or more to less than 6 Ω impedance. You can set up by viewing the guidance displayed on the TV screen. Press RECEIVER and then HOME on the remote controller. Select "Setup" - "2.Speaker Setup" - "Speaker Settings" - "Speaker Impedance" and change the default value from "6ohms" to "4ohms".

- Select the item with the cursor buttons of the remote controller and press ENTER to confirm your selection. To return to the previous screen, press RETURN.



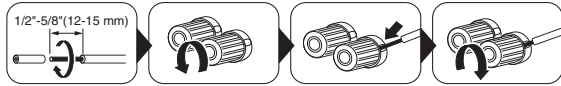

Cut and remove the plastic coating from the end of the speaker cable, twist the core and connect it to the terminal. Make correct connection between the unit's jacks and speaker's jacks (+ to + and - to -) for each channel. If connection is wrong, a bass sound may become poor due to reverse phase. Attaching the supplied colored speaker cable labels to the + side on the both ends of each channel's cable will help correct connection.

### Connecting the Subwoofer

Up to four subwoofers with built-in power amplifier can be connected to the subwoofer jacks. Set the cut-off filter selection switch of the subwoofer to DIRECT. If the subwoofer does not have a cut-off filter selection switch but has a cut-off frequency adjusting dial, turn it to the maximum frequency. If your subwoofer does not have built-in power amplifier, you can connect a power amplifier between the unit and the subwoofer.

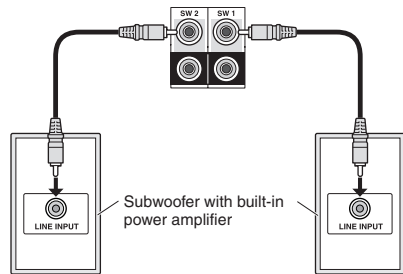

- The speaker setting is 7.2 ch at the time of purchase. You can change it manually or by using automatic speaker setting.
- Short-circuiting the + cable and - cable or contacting the cable core to the rear panel of the unit may cause failure. Also do not connect two or more cables to one speaker terminal or one speaker to several terminals.
- Using a speaker with less impedance than the setting may result in failure.

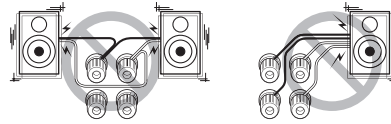
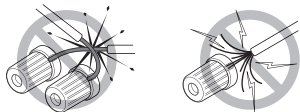

**When using commercially available banana plugs:** tighten the speaker terminals to the end and then insert the banana plugs. Do not insert the cable core directly into the hole for banana plug of speaker terminal. (North American model)

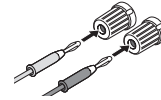

## 3 Other connections

### AM/FM Antenna Connections

Connect the antennas to listen to AM/FM broadcast. When listening to the broadcast for the first time, adjust the antenna position and orientation to get the best reception.

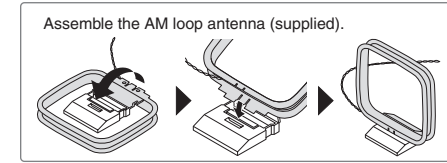
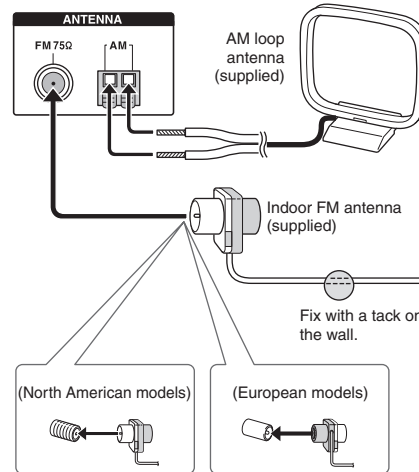

### Network Connection

You can enjoy Internet radio and DLNA by connecting the unit to LAN. The unit can be connected to the router with an Ethernet cable or to the wireless LAN router with Wi-Fi connection. In case of wired connection, connect the Ethernet cable to the Ethernet port. See "4th Step : Network Connection" of "Step 2: Setting Up".

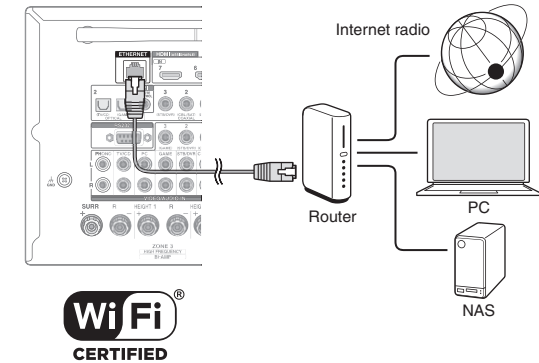

### Headphones Connection

Connect stereo headphones with a standard plug (1/4 inch or  $\phi$  6.3 mm) to the PHONES jack on the front panel. Sound from the speakers will be off while you are using the headphones.

- If you selected any other listening mode than Pure Audio, Stereo, Mono and Direct, connecting headphones will switch the listening mode to Stereo.

# Step 2: Setting Up

**Important:** When the unit is turned on for the first time, the setup wizard of the section 2 will automatically be launched. If you use the setup wizard to make the initial setup, connect a TV to the HDMI OUT MAIN or SUB jack of the unit via HDMI connection.

## 1 Turning the power on

Connect the power cord to the outlet. Press **ON/STANDBY** on the main unit or **RECEIVER** on the remote controller to turn the unit on or to standby mode.

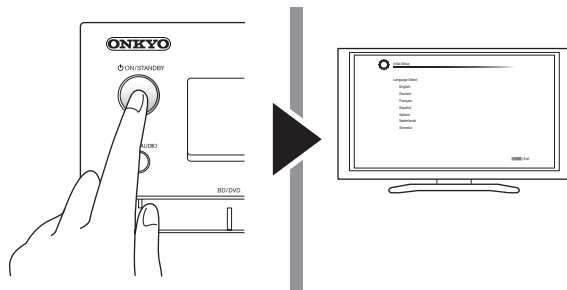

\* This unit includes a removable power cord. Connect the power cord to AC INLET of the unit and then connect to the outlet. Always disconnect the outlet side first when disconnecting the power cord. When the unit is turned on, a large instantaneous current may flow affecting functionality of the computer and other devices. It is recommended to use a separate outlet from that for the computer or such other sensitive devices.

**Firmware update notification:** If the unit is connected via LAN and there is firmware update available, the "Firmware Update Available" message will appear. To execute updating, select "Update Now" with the cursor buttons of the remote controller and press ENTER. When "Completed!" appears, press **ON/STANDBY** on the main unit to turn the unit into standby mode. Then updating will be completed.

- The unit automatically turns itself into standby mode 3 minutes after "Completed!" appears on the display. In this case also, updating will be completed.

## 2 Making the Initial Setup with the Setup Wizard

**Read before starting the procedure:** Set up by answering the guidance displayed on the TV screen. Select the item with the cursor buttons of the remote controller and press ENTER to confirm your selection. To return to the previous screen, press RETURN.

- If you terminate the procedure on the way or change the setting made in the initial setup and want to call up the setup wizard again, press **RECEIVER** and then **HOME** on the remote controller, select "Setup" - "7.Hardware Setup" - "Initial Setup", and press ENTER.

Select the language first. In the next screen, the summary of the setup wizard as below will be displayed. Select "Yes" in this screen and press ENTER on the remote controller.

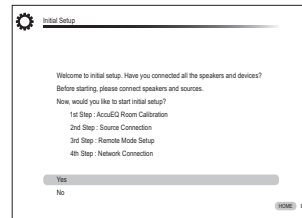

The setup wizard proceeds in the four steps as below.

- 1st Step : AccuEQ Room Calibration
- 2nd Step : Source Connection
- 3rd Step : Remote Mode Setup
- 4th Step : Network Connection

### ■ 1st Step : AccuEQ Room Calibration

The test tone coming from each speaker will be measured to enable setting of the number of speakers, volume level, each speaker's optimum crossover frequencies, and distance from the primary listening position, and also enable correction of distortion caused by the room acoustic environment.

- You cannot return to the previous screen during speaker setup, even if you press RETURN.
- You cannot setup the wide speaker setting in the setup wizard. For details on setting up the wide speakers, see the Advanced Manual.

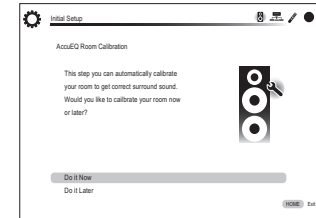

### 1. Place the speaker setup microphone.

When the start screen above is displayed, before starting the procedure, place the supplied speaker setup microphone at the measurement position ★ by referring to the figure below.

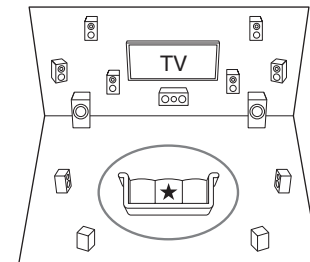

○ : Listening area

★ : Measurement position with microphone

- \* Correct measurement will not be possible if the microphone is held by hand. Measurement is not possible if headphones are being used.
- \* The subwoofer sound may not be detected since it is extremely low frequencies. Raise the subwoofer volume to around the half of its maximum volume and make its frequency to the maximum level.
- \* A loud test tone will be heard during measurement. Measurement may be interrupted if there is ambient noise or radio frequency interference. Close the window and turn off the home appliance and fluorescent light.



- After placing the microphone at the measurement position, select "Do it Now" with the cursors and press ENTER.
- Connect the microphone to the SETUP MIC jack of the unit.

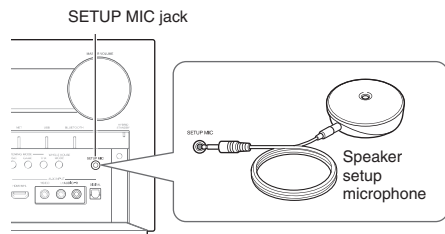

- Follow the guidance displayed on the TV screen.

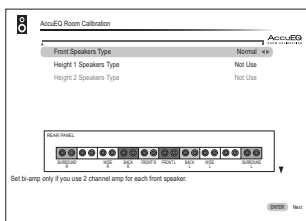

When the screen above is displayed, set the items with the cursors on the remote controller. Select the types for height 1/2 speakers if the height speakers are used. After front and height speakers types are selected, switch the screen using cursor ▼ to select the type of subwoofer. After setting the items, press ENTER on the remote controller. Press ENTER again in the next screen to start automatic speaker setting.

- Speaker terminals and settings description display at the bottom of the screen as you move the cursor to each item. Please refer to this information on the screen.
- The test tones sound from the connected speakers and automatic speaker setting starts. Measurement will be made twice for each speaker. It takes several minutes to be completed. Keep the room as quiet as possible during measurement. If any of the speakers do not produce the test tone, check for disconnection.
    - During measurement, each speaker outputs the test tones at a high volume. Be careful of sound leak that may disturb your neighbors, or be careful not to frighten young children.
  - When the measurement is completed, the measurement result is displayed.

Press ◀▶ on the remote controller to check the settings. Press ENTER with "Save" selected. In the next screen showing that "AccuEQ Room Calibration" is "On", press ENTER on the remote controller.

- If there is an error message, follow the on-screen instruction to remove the error cause.

#### About THX playback

THX recommends setting the speakers manually if you use THX-certified speakers or playing back with THX listening modes.

- THX recommends setting the crossover frequency to "80Hz(THX)" manually.
- Due to the electrical complexities and the interaction with the room, you may notice irregular results when setting the level or distance of each speaker. If this happens, THX recommends setting the speakers and the subwoofer manually.

- When "Please unplug setup microphone." is displayed, disconnect the microphone.

### 2nd Step : Source Connection

You can check whether or not each input source is connected correctly.

- When the Source Connection start screen is displayed, select "Yes, Continue" with the cursors and press ENTER.

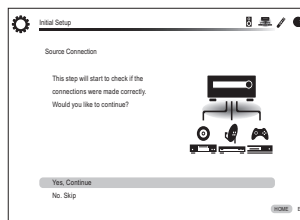

- Select the desired input to check the connection and press ENTER. Start playback of the selected device. If connection is correct, video/audio of the input source selected on the unit will be played.
- After checking the connection, select "Yes" with the cursors and press ENTER.
  - If you select "No" and press ENTER, the error cause will be displayed. Follow the guidance to remove the error cause and check the connection again.

- Select "Yes" with the cursors and press ENTER on the remote controller to check the connection of other inputs or select "No, Done Checking" and press ENTER to skip. If you select "Yes", you will return to the screen of step 2. If you select "No, Done Checking", you will proceed to step 5.
- Enabling HDMI Linked Operation and Other Functions In the next screen, you can enable the HDMI linked operation with CEC compliant device, connection with ARC compatible TV, and HDMI Through function. Select "Yes" with the cursors to enable them or "No, Done Checking" to skip, and press ENTER on the remote controller.
- Select "Yes" with the cursors and press ENTER to enable the CEC link function or select "No" and press ENTER to keep it disabled.

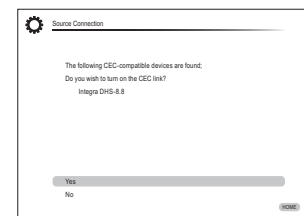

If you select "Yes", the connection with ARC compatible TV and HDMI Through function will be set to "Auto" and enabled.

### 3rd Step : Remote Mode Setup

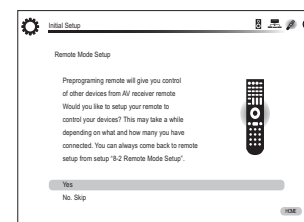

In this step, you can enable operation of the other components using the remote controller of the unit. When the Remote Mode Setup start screen is displayed, select "Yes" with the cursors and press ENTER on the remote controller. Follow the guidance to select the desired REMOTE MODE button and in the keyboard screen, enter the first three characters of the brand name of the device you are going to program (e.g., "ONK" for ONKYO) and search for the remote control code. The guidance will also explain how to set the remote controller.

## ■ 4th Step : Network Connection

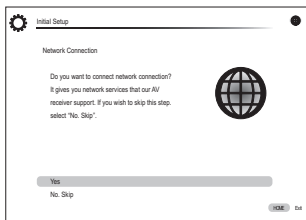

You can check the network connection and make the Wi-Fi setting. When the Network Connection start screen is displayed, select "Yes" with the cursors and press ENTER on the remote controller. If you select "Wired" in the next screen, you can view the Ethernet cable connection status. To make the Wi-Fi setting, select "Wireless", press ENTER on the remote controller and follow the sections below.

### Make the following preparations.

Wi-Fi connection requires an access point such as wireless LAN router (\*). Write down the SSID and password (key) of the access point if they are shown in the label of the main body. If the access point has an automatic setting button (may be called differently according to the manufacturer), you can set up without inputting the password. For how to use the automatic setting button of the access point, refer to its instruction manual.

\* The unit supports Wi-Fi connection with 2.4 GHz access point.

### 1. Select the SSID of the access point to be connected with the cursor buttons and press ENTER.

When the SSID of the access point appears on the TV screen, select the desired access point.

- If you changed the initial setting of the access point to skip password entry, step 3 starts automatically.
- If you changed the initial setting of the access point to hide the SSID, see "When the access point is not displayed".

### 2. Select and set the authentication method.

The "Enter Password" screen may be displayed, instead of the screen shown below, if the access point device does not have an automatic setting button.

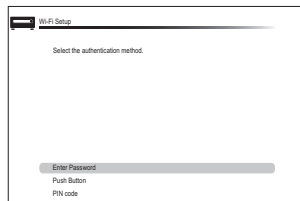

When the screen above is displayed, select and set one of the three authentication methods: "Enter Password", "Push Button" and "PIN code". See below for details of and how to set each method.

**Enter Password:** Enter the password of the access point to establish connection.

- ① Select "Enter Password" with the cursor buttons and press ENTER.
- ② Enter the password (\* ) on the keyboard screen, select "OK" with the cursor buttons and press ENTER.

\* Select "Shift" and press ENTER to toggle between upper and lower case. Select "←" or "→" and press ENTER to move the cursor to the selected direction. Select "Back Space" and press ENTER to delete the character at the left of the cursor position. To select whether to mask the password with "\*" or display it in plain text, press D on the remote control. Press + 10 on the remote controller to enable the "Shift" function and CLR to delete all the input characters.

- ③ If the security method of the access point to be connected is WEP, select "Default Key ID", select "OK" and press ENTER.

**Push Button:** Use the automatic setting button of the access point to establish connection.

- ① Select "Push Button" with the cursor buttons and press ENTER.
- ② Hold down the automatic setting button of the access point for the necessary seconds, select "OK" with the cursor buttons and press ENTER.

**PIN code:** Select this method when the automatic setting button of the access point is beyond the reach. Select "PIN code" with the cursor buttons and press ENTER to display the 8-digit PIN code. Register the displayed PIN code to the access point, select "OK" with the cursor buttons and press ENTER. For how to register the PIN code to the access point, refer to its instruction manual.

### 3. Establish connection.

The connection process starts and the Wi-Fi indicator on the left of the unit's display starts flashing. When connection has been established, the Wi-Fi indicator changes from flashing to staying lit. If the Wi-Fi indicator

does not stay lit, connection has not been established. Make the setting again. If "Push Button" does not work, try "Enter Password".

### When the access point is not displayed

Select "Other..." with the ► cursor on the remote controller and press ENTER to display the keyboard screen. Input the SSID and password. Make the following settings according to the router setting.

#### ■ WPA/WPA2 method

Select "WPA" or "WPA2" in "Security Method", select "OK" and press ENTER.

#### ■ WEP method

Select "WEP" in "Security Method" and select "Default Key ID". Then select "OK" and press ENTER.

- If encryption setting has not been made on the wireless LAN router, select "None" in "Security Method", select "OK" and press ENTER.

## ■ Exiting the setup wizard

After finishing the initial setup, keep "Finished" selected and press ENTER on the remote controller. Connection and setting of the unit is now completed. See Step 3 and enjoy your home theater.

# Step 3: Playing Back

## 1 Playing the player and TV

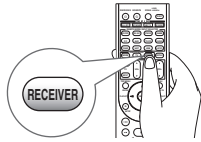

● **To control the unit:** The remote controller of this unit has the remote mode function for controlling other devices. You cannot control this unit when the remote controller is in the remote mode other than RECEIVER mode (for controlling this unit). Be sure to press ⑨ RECEIVER to select the RECEIVER mode before starting operation.

### 1. Turning the power on

Press ① **RECEIVER** on the remote controller to turn the power on.

- Switch the input on the TV to that assigned to the unit. Use the TV's remote controller.

### 2. Select the input of the unit and start playback on the player or TV.

- Press ② **INPUT SELECTOR** to which the desired player has been assigned. Press TV/CD to play the TV's sound. You can also use the input selector buttons on the main unit.
- Input will automatically be selected if the TV or player is CEC compliant and connected to the unit with HDMI cable.

### 3. Select the desired listening mode.

Press ⑤ listening mode buttons to switch the mode so that you can enjoy different listening modes. For details about the listening modes, see "Listening modes" on the next section.

### 4. Adjust the volume with ⑪.

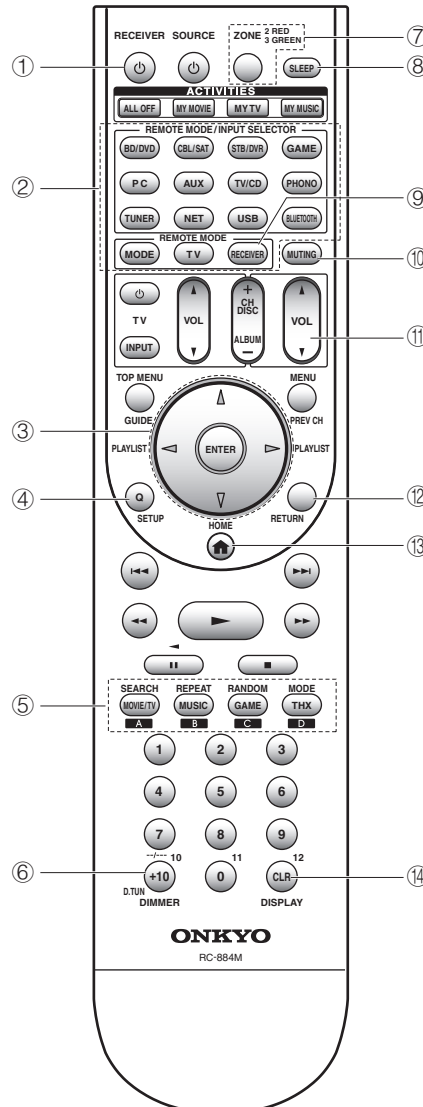

## Remote Controller Parts Name

- ① **RECEIVER button:** Turns the unit on or into standby mode.
  - ② **REMOTE MODE/INPUT SELECTOR button:** Switches the input to be played.
  - ③ **Cursor buttons and ENTER button:** Moves the cursor and confirms the selection.
  - ④ **Q SETUP button:** Displays the Quick Setup menu that allows you to set the frequently used functions including input selection and volume adjustment.
  - ⑤ **Listening mode buttons:** Allows you to select the listening mode.
  - ⑥ **DIMMER button:** Switches the brightness of the display. This button also turns MASTER VOLUME indicator on and off.
  - ⑦ **ZONE button:** For use when the unit is connected with an integrated amplifier in a separate room and sound is played there.
  - ⑧ **SLEEP button:** Sets the time until the unit enters standby mode automatically.
  - ⑨ **RECEIVER button:** Switches the remote controller to the mode for operating this unit.
  - ⑩ **MUTING button:** Temporarily mutes audio.
  - ⑪ **VOLUME buttons:** Allows you to adjust the volume. This button also cancels the muting.
  - ⑫ **RETURN button:** Returns the display to the previous state.
  - ⑬ **HOME button:** Displays the Home menu that allows you to make advanced settings and use Internet radio and DLNA.
  - ⑭ **DISPLAY button:** Switches the information on the display.
- The buttons other than ① to ⑭ are for operating other devices.

## Listening Modes

You can select a listening mode from various options such as Dolby Digital, Dolby Atmos and DTS. Select the desired mode by switching and listening actual sound in different modes. The selectable listening modes depend on the format of the input signals.

**MOVIE/TV:** You can select a listening mode suitable for movies and TV programs.

**MUSIC:** You can select a listening mode suitable for music.

**GAME:** You can select a listening mode suitable for games.

**THX:** You can select a THX listening mode.

**PURE AUDIO (main unit only):** The display and analog video circuits are cut off to provide purer sound.

- For details on the listening modes, see the Advanced Manual.

### "Direct" for playing the input signals as-is

Selecting this mode allows the input signals to be played as they are. For example, 2 ch signals of music CD will be played in stereo, 5.1 ch signals in 5.1 ch, and Dolby Digital signals of blu-ray disc or DVD in the Dolby Digital sound field according to the specified number of channels.

## Other Useful Functions

■ **Playing Video and Audio from Different Sources:** It is possible to play audio and video from different sources. For example, you can play audio from the CD player and video from the BD/DVD player. In this case, press BD/DVD and then TV/CD. Then start playback on the BD/DVD player and CD player. This function is effective when an input with audio only has been selected (TV/CD, TUNER or PHONO in the initial setting).

■ **Adjusting Sound Quality:** It is possible to enhance or moderate the low and high pitched ranges of front speakers. Press TONE on the main unit several times to select the desired setting from "Bass", "Treble", and "Phase Matching Bass" and adjust with +/-.

- It cannot be set if the listening mode is Pure Audio, Direct or THX.

"**Bass**": Allows you to enhance or moderate the low pitched range.

"**Treble**": Allows you to enhance or moderate the high pitched range.

"**Phase Matching Bass**": Allows you to keep the clear midrange and effectively enhance the low pitched range.

■ **Muting Temporarily:** Press MUTING on the remote controller. To cancel the muting, press MUTING again, or press VOL ▲/▼.

■ **Changing the Display Brightness:** Press DIMMER on the remote controller. The display brightness changes each time you press the button.

■ **Checking the Input Format:** Press DISPLAY on the remote controller several times to switch the display of the main unit in order of:

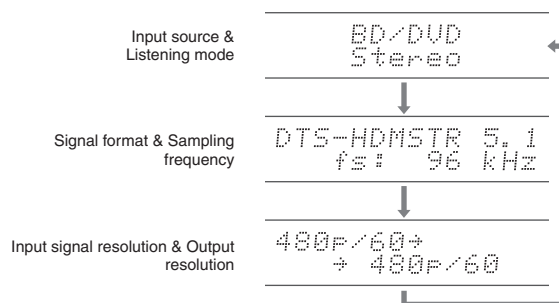

- If "Dolby D 5.1" is displayed in signal format, the Dolby Digital 5.1 ch signals are being input. When listening to AM/FM radio, the band, frequency and preset number are displayed.

## 2 Listening to AM/FM Radio

The Basic Manual explains the method using automatic tuning. For manual tuning, see the Advanced Manual.

- Press **TUNER** on the main unit several times to select either "AM" or "FM".
- Press **TUNING MODE** on the unit, so that the "AUTO" indicator on the display lights.
- Press **TUNING**▲ on the unit.

The automatic tuning to a radio station starts. Searching stops when one is tuned. When tuned into a radio station, the "▶TUNED◀" indicator on the display lights. The "FM STEREO" indicator lights if the radio station is an FM radio station.



(Actual display depends on the country.)

### Registering an AM/FM Radio Station

It allows you to register up to 40 of your favorite AM/FM radio stations.

- Tune into the AM/FM radio station you want to register.
- Press **MEMORY** on the unit.  
The preset number on the display flashes.
- Repeatedly press **PRESET**◀▶ on the unit to select a number between 1 and 40 while the preset number is flashing (about 8 seconds).
- Press **MEMORY** on the unit again.  
When registered, the preset number stops flashing. To select a preset radio station, press **PRESET**◀▶ on the main unit or **CH +/-** on the remote controller.

### 3 Connecting and playing the Bluetooth-enabled device

You can wirelessly enjoy music files stored in a smartphone or other Bluetooth-enabled device. The coverage area is 48 feet (15 meters).

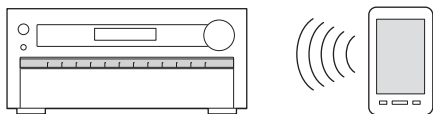

- The Bluetooth-enabled device needs to support the A2DP profile.
- This unit is compatible with SCMS-T copy protection scheme. It is possible to playback the music of Bluetooth-enabled devices that support SCMS-T protection scheme.
- Note that connection is not always guaranteed with all Bluetooth-enabled devices.

#### Pairing

Pairing is necessary when using the Bluetooth-enabled device for the first time. Before starting the procedure, learn how to enable the Bluetooth setting function and to connect with other devices on the Bluetooth-enabled device.

##### 1. Press **BLUETOOTH** on the remote controller.

The unit enters the pairing mode and the **BLUETOOTH** indicator starts flashing.

##### 2. While the **BLUETOOTH** indicator is flashing (about 2 minutes), complete connection on the Bluetooth-enabled device in the nearby area.

If the name of this unit is displayed on the Bluetooth-enabled device's display, select this unit. Pairing will be completed after a short time.

- If a password is requested, enter "0000".
- When connecting the unit to any other Bluetooth-enabled device, start pairing by holding down **BLUETOOTH** until the **BLUETOOTH** indicator starts flashing. This unit can store the data of up to ten paired devices.

#### Playing Sound of the Bluetooth-enabled Device

If the unit is on and the Bluetooth-enabled device is connected, the input will be automatically switched to **BLUETOOTH**. Play music in this state.

- It may take about a minute until connection is established when the unit is on since the Bluetooth function takes some time to start up.
- If the volume setting on the Bluetooth-enabled device is low, the sound will not be output from this unit.
- Due to the characteristics of Bluetooth wireless technology, the sound produced on this unit may slightly be behind the sound played on the Bluetooth-enabled device.

### 4 Using the Home menu

In the Home menu, you can make advanced setup and use Internet radio and DLNA function. For details on the operation, see the Advanced Manual.

##### 1. After pressing **RECEIVER**, press **HOME** on the remote controller.

The Home menu is displayed on the TV screen. You can also use the **HOME** button on the main unit.

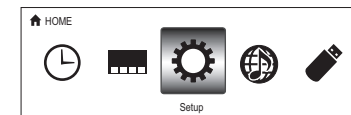

##### 2. Select the item with the cursor buttons of the remote controller and press **ENTER** to confirm your selection.

To return to the previous screen, press **RETURN**. To return to the Home menu, press **HOME**.

■ **Sleep Timer**: Select to turn the unit into standby mode automatically when the specified time elapses.

■ **InstaPrevue**: Select to preview videos input from the HDMI input jacks collectively in a single screen. The screen has a main window (current input video) and sub windows (other input videos). To switch the current input, select the desired sub window with the cursor buttons and press **ENTER**.

- A black sub window is shown for the input with no video signals.
- "InstaPrevue" cannot be selected if the video is being input from HDMI IN 5, 6 or 7 or if there is no signal from the input currently selected.
- "InstaPrevue" cannot be selected if "Zone 2 Monitor Out" is set to "Use" and Zone 2 is on.
- Depending on video signals, the picture may not be properly rendered on the preview thumbnails.

■ **Setup**: You can change the assignment of input terminals and input selector buttons and also make various speaker settings and other advanced settings.



## 5 Using Quick Setup menu

In the Quick Setup menu, you can set frequently used functions including input selection and volume adjustment.

### 1. Press Q SETUP on the remote controller.

The Quick Setup menu is displayed on the connected TV's screen.

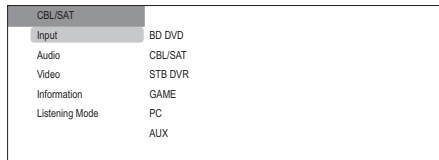

### 2. Select the item with the cursor buttons of the remote controller and press ENTER to confirm your selection.

- To return to the previous screen, press RETURN.

■ **Input:** Select the input and check the assignment of input selector buttons.

■ **Audio:** You can perform various audio settings including audio quality and speaker level adjustment.

- You cannot select this item when audio is output from the TV's speakers.

**A/V Sync:** If the video is behind the audio, you can delay the audio to offset the gap. Different settings can be set for each input.

- It cannot be set if the input is "NET", "USB" or "BLUETOOTH".
- It cannot be set if the listening mode is Pure Audio or Direct.

**Bass, Treble:** Adjust volume of the front speaker.

- It cannot be set if the listening mode is Pure Audio, Direct or THX.

**Phase Matching Bass:** Suppress phase shift in the midrange to enhance bass sound. Thus smooth and powerful bass sound can be obtained.

- It cannot be set if the listening mode is Pure Audio, Direct or THX.

■ **Network Service:** Select to use Internet radio services and the DLNA function. When you connect the unit to the network and press ENTER, the network service screen will be displayed on the TV. On the TV screen, select the desired service or music file with the cursors of the remote controller and press ENTER to confirm and start playback.

**Internet radio service:** You can listen to Tuneln or such other Internet radio stations registered in advance.

**DLNA :** You can play music files stored in the PC or NAS device connected to the network. Select the server with the cursors, select the desired music file and press ENTER to start playback.

**Home Media:** You can play music files in a shared folder on the PC or NAS device connected to the network. Select the server with the cursors, select the desired music file and press ENTER to start playback.

- "Network Service" becomes selectable after the network starts up even if it cannot be selected first. It may take about a minute to start up.
- When "Network Service" is selected for the first time, the "DISCLAIMER" screen will appear on the TV. Select "Agree" if you agree the content. If you do not agree the content, you cannot use the network service.

\* You cannot use the function unless the TV is connected via HDMI since selecting "Agree" in the "DISCLAIMER" screen is not possible.

- Layout of the icons in the "Network Service" top menu can be changed. Press NET on the remote controller and press D. Select the source icon with the cursors and press ENTER, and then select the destination icon and press ENTER. The positions of the icons are switched each other.

■ **USB:** Select "USB" in the TV screen and connect a USB storage device to the USB port on the front panel. On the TV screen, select the desired folder or music file with the cursors of the remote controller and press ENTER to confirm and start playback.

- "USB" becomes selectable after the USB function starts up even if it cannot be selected first. It may take about a minute to start up.

**Subwoofer 1/2 Level, Center Level:** Adjust the speaker level while listening to the sound. The adjustment you made will be reset to the previous status when you turn the unit to standby mode.

- The speakers cannot be adjusted if they have been set to "No" or "None" in "Speaker Configuration".
- "Subwoofer 2 Level" cannot be adjusted if "Subwoofer" have been set to "1ch" in "Speaker Configuration".

**AccuEQ Room Calibration:** Disable the sound field set in the automatic speaker setting. The setting can be separately set to each input.

- This setting cannot be selected if the automatic speaker setting has not been performed.
- It cannot be set if headphones are connected or the listening mode is Pure Audio or Direct.

**Late Night:** Make small sounds to be easily heard. It is useful when you need to reduce the volume while watching a movie late night. You can enjoy the effect on Dolby Digital and Dolby Digital Plus only.

- Turning the unit to standby mode will set the setting to "Off".
- This function cannot be used if "Loudness Management" is set to "Off".

**Music Optimizer:** Improve the quality of the compressed audio. Playback sound of lossy compressed files such as MP3 will be improved. The setting can be separately set to each input.

- The setting is effective in the signals of 48 kHz or less. The setting is not effective in the bitstream signals.
- It cannot be set if the listening mode is Pure Audio or Direct.

**Re-EQ, Re-EQ (THX):** Adjust the soundtrack that was processed to enhance its high pitch range, in order to make it suitable for home theater.

- In Re-EQ, the following listening modes can be used: Dolby Digital, Dolby Digital Plus, Dolby TrueHD, Multichannel, DTS, DTS-HD High Resolution Audio, DTS-HD Master Audio, DTS Express, DSD, and DTS Neo:X Cinema.
- In Re-EQ (THX), the following listening modes can be used: THX Cinema, THX Surround EX, and THX Select2 Cinema.



**Screen Centered Dialog:** Height speakers are used to move acoustic images such as dialogs from the center speakers upward according to the height of the TV screen. Acoustic images of the center speakers move up as the set value is increased.

- This item may not be available depending on the selected listening mode.
- This function cannot be used if headphones are connected.
- This function cannot be used if "Height 1 Speakers Type" is not set to "Front High".

**Speaker Layout:** You can give priority to surround back speakers, height 1/2 speakers or wide speakers when they are all connected.

**Back+Height 1:** Audio outputs from surround back speakers and Height 1 speakers are given priority.

**Back+Wide:** Audio outputs from surround back speakers and wide speakers are given priority.

**Height 1+2:** Audio outputs from Height 1 speakers and Height 2 speakers are given priority.

**"Back" and "Height 1":** Displayed when Zone 2 playback is performed via Height 2/ wide speaker terminals (ZONE 2 terminals) while surround back and Height 1 speakers are connected. "Back" means that audio outputs from surround back speakers are given priority.

"Height 1" means that audio outputs from Height 1 speakers are given priority.

**"Back" and "Wide":** Displayed when speakers are bi-amp connected or Zone 3 playback is performed via Height 1 speaker terminals (ZONE 3/Bi-AMP terminals) while surround back and wide speakers are connected. "Back" means that audio outputs from surround back speakers are given priority. "Wide" means that audio outputs from wide speakers are given priority.

**"Back" and "Height 2":** Displayed when speakers are bi-amp connected or Zone 3 playback is performed via Height 1 speaker terminals (ZONE 3/ Bi-AMP terminals) while surround back and Height 2 speakers are connected. "Back" means that audio outputs from surround back speakers are given priority. "Height 2" means that audio outputs from Height 2 speakers are given priority.

- Selectable items vary depending on the playing conditions such as input source, speaker configuration etc.
- The speakers cannot be selected if they have been set to "None" in "Speaker Configuration".
- This function cannot be used if "11ch Playback" is set to "Yes".
- This function cannot be used in the listening mode which does not use surround back speakers, height 1/2 speakers or wide speakers.

- This function may not be effective depending on the selected listening mode or input source.

#### ■ Video:

**Monitor Out:** The video input signals input to the unit will be converted by the unit when they are output from the HDMI OUT jack to the TV so that their resolution can match that of the TV used. Select the HDMI OUT jack to be used for output.

**Control Monitor:** Select the main room TV or the separate room TV for which the CEC link function is enabled when HDMI connection between the unit and the separate room TV is established by Zone function.

- For details on Zone function, see the next section "Using the multi-zone function".

**Wide Mode:** You can set the aspect ratio.

**Picture Mode:** You can adjust the image quality. "Cinema" will automatically adjust the image to be suitable to watch movie and "Game" suitable to play game. In "Standard", the resolution will be changed but the image quality will not be adjusted. In "Custom", "ISF Day" and "ISF Night", you can adjust the brightness, contrast, hue and saturation as desired. If you do not adjust the resolution and image quality, select "Bypass".

- "Video" cannot be selected if the input is "NET", "USB" or "BLUETOOTH".

#### ■ Information:

**Audio:** Displays the audio input source, format, number of channels, sampling frequency, listening mode, number of output channels, and other audio information.

**Video:** Displays the video input source, resolution, signal format, color tone, 3D information, Aspect, Picture Mode, output, and other Video information.

**Tuner:** Displays the band, frequency, preset number, and other tuner (radio) information.

## 6 Using the multi-zone function

The function allows you to connect the unit with a TV or audio equipment placed in a separate room so that you can enjoy audio and video of the connected equipment even if you are staying in a different room. It is possible to perform playback in the main room and a separate room at the same time, for example by playing the Blu-ray Disc player in the main room where the unit is placed while playing Internet radio in a separate room. It is also possible to perform playback only in a separate room. There are four methods to configure multi-zone connection as described in "a" to "d" in the right. Simultaneous playback in all zones is also possible.

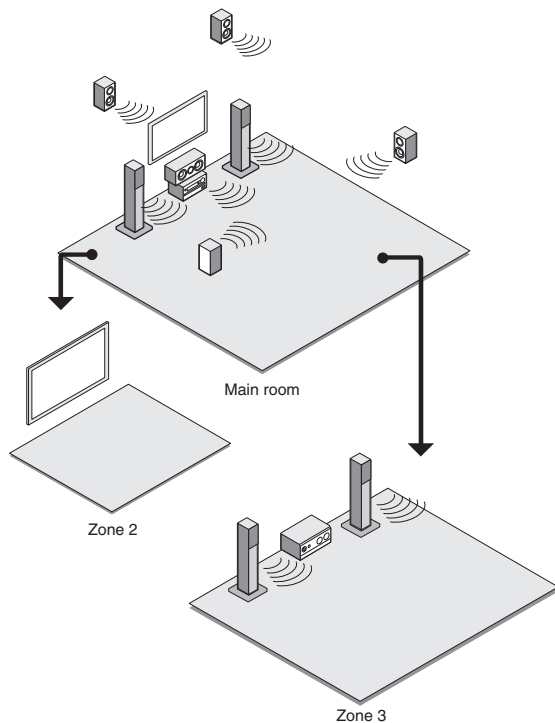

● **The sources from which you can enjoy the sound in a separate room:** For Zone 2, any can be selected from among an external device connected to the HDMI input jack or the analog audio input jacks (\*) of the unit, the "NET", "USB" or "BLUETOOTH" source, and the AM/FM

broadcasting. For Zone 3, any can be selected from among an external device connected to the analog audio input jacks (\*) of the unit, the "NET", "USB" or "BLUETOOTH" source, and the AM/FM broadcasting.

\* When you connect a CD player or such other player without HDMI output jack, connect it to the analog audio input jacks of the unit. Multi-zone output is not possible if the connection is only with digital optical cable or digital coaxial cable. In case of analog connection, analog audio output setting may be necessary on the player.

- As for HDMI input and analog audio input, it is possible to play the same source or different sources in the main room and separate room.
- As for the "NET", "USB" and "BLUETOOTH", you cannot select different audio sources for the main room and separate room. For example, if "NET" has been selected in the main room and then "USB" is selected as playback source in the separate room, the input in the main room will change to "USB" accordingly.
- When listening to AM/FM broadcasting, you cannot select different stations for the main room and separate room. Therefore broadcasting of the same station will be heard in the both rooms.
- If you play the same HDMI connected player for the main room and a separate room, the sound field processing for 2 ch PCM signals will be made in the main room.

### Outputting Video/Audio to a Separate Room

#### ■ a. Connecting a TV in a separate room using HDMI cable

You can play video and audio of the HDMI connected player on the TV in a separate room. With an HDMI cable, connect between the HDMI OUT ZONE 2 jack of the unit and the HDMI IN jack of the TV in a separate room.

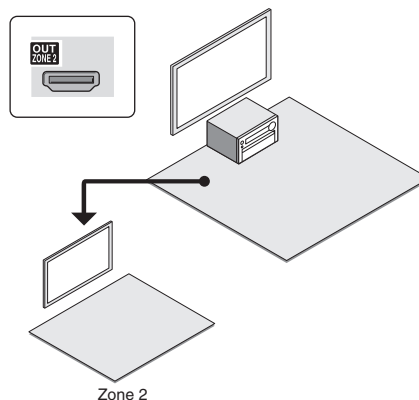

**Change the setting:** Press RECEIVER and then HOME on the remote controller, select "Setup" - "1.Input/Output Assign" - "Monitor Out" - "Zone 2 Monitor Out" and set the setting to "Use".

- You can view the information of the connected device on the TV of Zone 2 by pressing DISPLAY during Zone 2 playback.

#### ■ b. Connecting a TV in a separate room using composite video cable

Video from the player without HDMI out jack can be displayed on the TV in a separate room. First, connect the player to composite video input jack of the unit. Then, connect the TV in the separate room to ZONE 2 OUT V jack of the unit using a composite video cable.

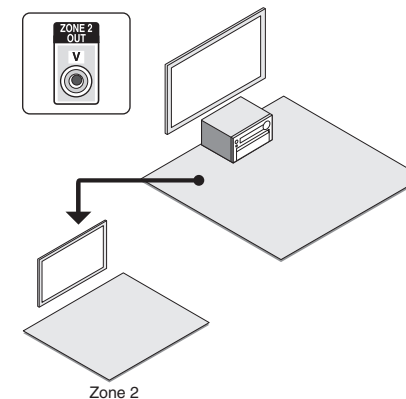

- It is not possible to output video from the player to the TV in the separate room if the player is connected to the HDMI IN jack or COMPONENT VIDEO IN jack.
- In this connection method, audio from the player cannot be output from the TV. To output audio in the separate room, see the next section "Listening to Music in a Separate Room" and connect the unit to the integrated amplifier or speakers located in the room where the TV is placed.

## Listening to Music in a Separate Room

### ■ c. Connecting an Integrated Amplifier in a Separate Room

It is possible to play 2 ch source in a separate room while 9.2 ch source is being played in the main room. Connect the PRE/LINE OUT ZONE 2 jacks or PRE/LINE OUT ZONE 3 jacks of the unit and the line-in jacks of the pre-main amplifier in a separate room with an analog audio (RCA) cable.

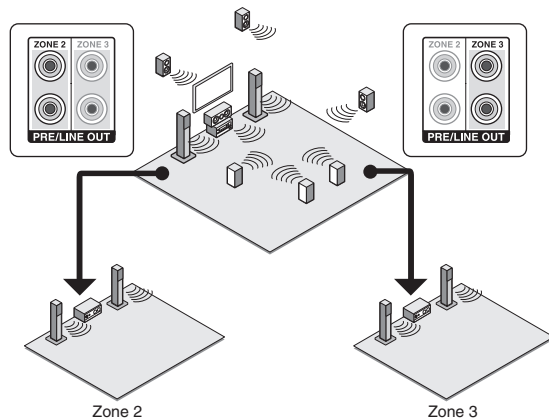

- Volume can be adjusted with both the unit and the pre-main amplifier used in a separate room. To adjust it with the unit, press RECEIVER and then HOME on the remote controller, select "Setup" - "7. Hardware Setup" - "Multi Zone" - "Zone 2 Out" or "Zone 3 Out" and set the setting to "Variable". If you connect a power amplifier, be sure to make the setting and adjust the volume in the main room.

### ■ d. Connecting Speakers in a Separate Room

It is possible to directly connect the speakers in another room without an amplifier. Connect the speakers in the separate room to ZONE2 or ZONE3 speaker terminals of the unit using speaker cables. Note that 7.2 ch will be the maximum in the main room during Zone 2 or Zone 3 playback. When both Zone 2 and Zone 3 playbacks are performed at the same time, 5.2 ch will be the maximum in the main room.

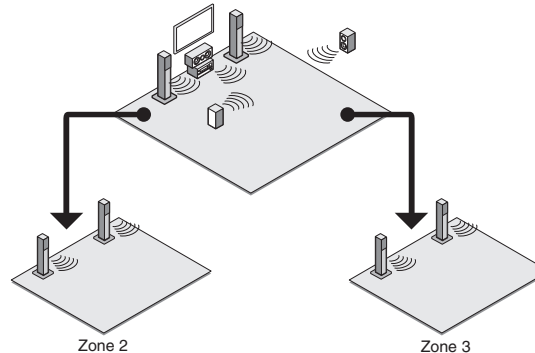
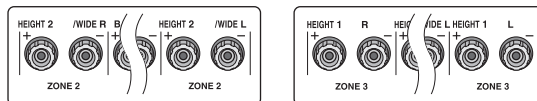

**Required setting:** Press RECEIVER and then HOME on the remote controller. Select "Setup" - "2. Speaker Setup" - "Speaker Settings" and set "Powered Zone 2" or "Powered Zone 3" to "Yes".

- Volume adjustment can be performed only from the unit.

## Performing Multi-zone Playback

### 1. Press ZONE on the remote controller a repeatedly to select Zone 2 or Zone 3. Point the remote controller at the unit and press ◊RECEIVER.

"Z2" or "Z3" lights on the main unit display and Zone function is enabled.

- The Zone button stays lit red when Zone 2 is selected and green when Zone 3 is selected.

### 2. Press INPUT SELECTOR of the input source to be played in a separate room.

If you turn the unit to standby during multi-zone playback, the Z2/Z3 indicators are dimmed and the playback mode is switched to playback in a separate room only. Performing steps 1 and 2 while the unit is in standby also switches the playback mode to playback in a separate room only.

**To control on the main unit:** Press ZONE2 or ZONE3 and within 8 seconds, press the input selector button of the input to be played in a separate room. To play the same source in the main room and separate room, press ZONE2 or ZONE3 twice.

**To turn off the multi-zone function:** Press ZONE on the remote controller repeatedly to select Zone 2 or Zone 3. Press ◊RECEIVER. To control on the main unit, press ZONE2 or ZONE3 and within 8 seconds, press OFF.

**To adjust the volume:** Press ZONE on the remote controller a repeatedly to select Zone 2 or Zone 3. Adjust the volume using VOL ▲/▼. To do this on the main unit, press ZONE2 or ZONE3, and adjust the volume using the MASTER VOLUME control within 8 seconds.

**To temporarily mute the audio:** Press ZONE on the remote controller repeatedly to select Zone 2 or Zone 3. Then, press MUTING to mute the audio.

**To adjust the sound quality for the separate room:** Press ZONE2 on the main unit. Press TONE a few times to display "Bass", "Treble" or "Balance" on the display. When the desired item appears on the display, adjust the value with + or - button.

- If "Zone 2 Out" is set to "Fixed", sound quality adjustment are not effective.
- If Zone 2 or Zone 3 is on, power consumption during standby becomes larger than normal.
- If Zone 2 or Zone 3 is turned on when the listening mode of the main room is Pure Audio, it will automatically switch to Direct.
- While Zone 2 or Zone 3 is on, the RI linked system function (interlink between Onkyo components) is disabled.

**WHOLE HOUSE MODE:** If you press WHOLE HOUSE MODE while playback is being performed in the main room, the WHOLE HOUSE MODE is turned on, "Z2" and "Z3" on the display light at the same time and the playback sources of all the rooms are switched to the same source at once.

- WHOLE HOUSE MODE is effective only for playback of the external player connected to the analog audio input jacks.
- This function cannot be used if headphones are connected or audio is output from the speakers of the TV.

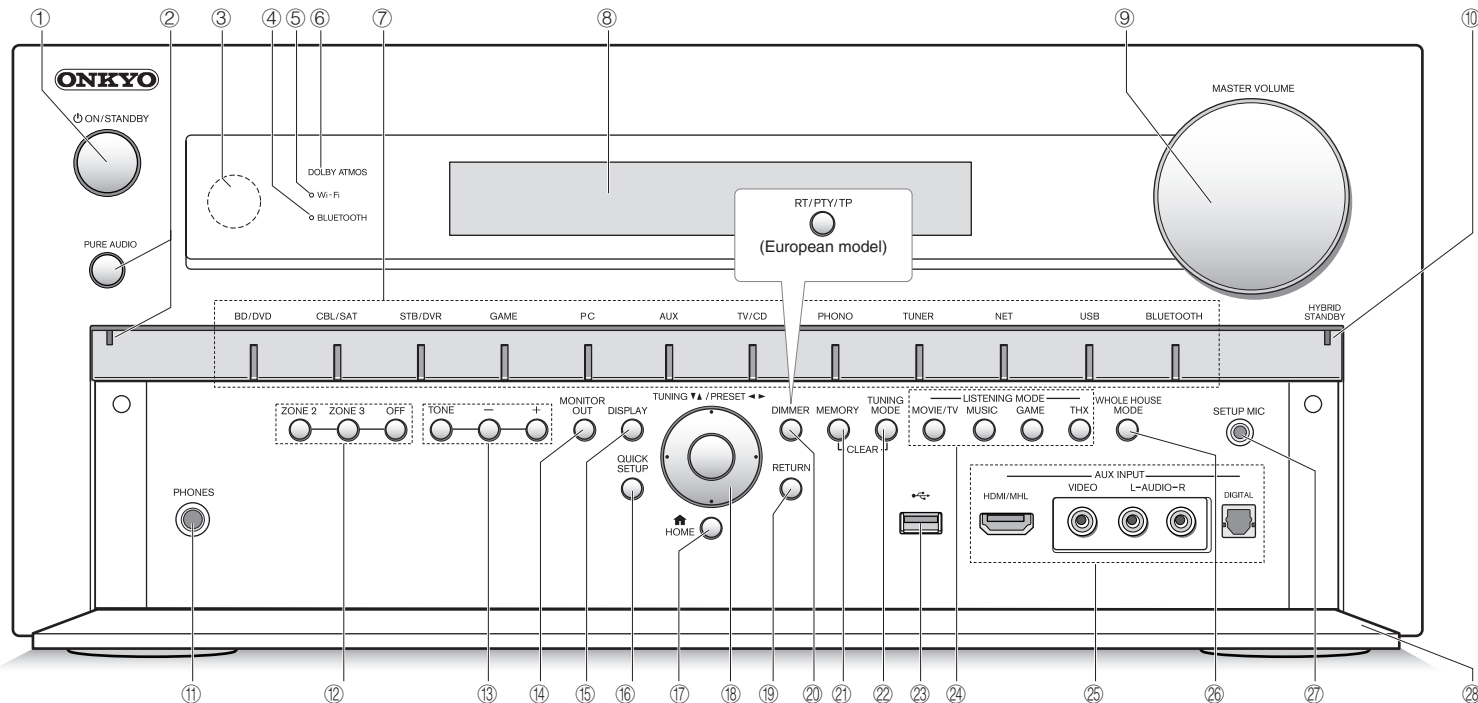

## Front Panel

- ① **ON/STANDBY button:** Turns the unit on or into standby mode.
- ② **PURE AUDIO button and indicator:** Switches to the Pure Audio mode.
- ③ **Remote control sensor:** Receives signals from the remote controller.
- ④ **BLUETOOTH indicator:** Flashes while pairing with a Bluetooth-enabled device in progress and stays lit when pairing is completed.
- ⑤ **Wi-Fi indicator:** Stays lit while the unit is connected to the wireless LAN router.
- ⑥ **DOLBY ATMOS indicator:** Stays lit when the Dolby Atmos listening mode is selected with Height speakers or surround back speakers enabled.
- ⑦ **Input selector buttons:** Switches the input to be played.
- ⑧ **Display**
- ⑨ **MASTER VOLUME control and indicator:** Allows you to adjust the volume.
- ⑩ **HYBRID STANDBY indicator:** Lights if the unit enters standby mode when the HDMI Through, network standby or Wakeup from Bluetooth function is enabled.
- ⑪ **PHONES jack:** Stereo headphones with a standard plug are connected.
- ⑫ **ZONE 2 button, ZONE 3 button and OFF button:** Controls the multi-zone function.
- ⑬ **TONE and Tone Level buttons:** Adjusts the high tone and low tone.
- ⑭ **MONITOR OUT button:** Allows you to select the HDMI jack to output the video input signals that are input to the unit.
- ⑮ **DISPLAY button:** Switches the information on the display.
- ⑯ **QUICK SETUP button:** Displays the Quick Setup menu.
- ⑰ **HOME button:** Displays the Home menu.
- ⑱ **Cursor buttons, TUNING▼▲ button, PRESET◀▶ button and ENTER button:** Moves the cursor and confirms the selection. When listening to AM/FM broadcasting, tune into the station with TUNING▼▲ or select the registered station with PRESET◀▶.
- ⑲ **RETURN button:** Returns the display to the previous state.

- 20 **DIMMER button (North American models):** Switches the brightness of the display.
- RT/PTY/TP button (European model):** Can be used when receiving the station transmitting text information.
- 21 **MEMORY button:** Registers or deletes a station.
- 22 **TUNING MODE button:** Switches the tuning mode.
- 23 **USB port:** A USB storage device is connected so that music files stored in it can be played.
- 24 **LISTENING MODE buttons:** Allows you to select the listening mode.
- 25 **AUX INPUT HDMI/MHL jacks:** An HD video camera or MHL-enabled mobile device is connected. It is possible to send video and audio of an MHL-enabled mobile device.
- AUX INPUT AUDIO/VIDEO, DIGITAL jacks:** A video camera or such other device is connected.
- 26 **WHOLE HOUSE MODE button:** Controls the WHOLE HOUSE MODE function to play the same source in all the multi-zone connected rooms.
- 27 **SETUP MIC jack:** The supplied speaker setup microphone is connected.
- 28 **Front flap**

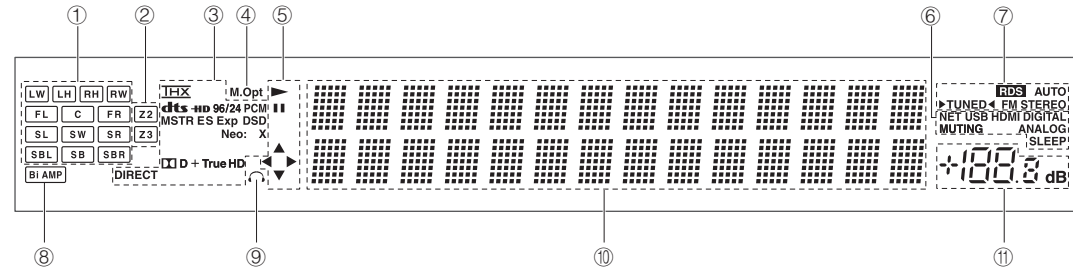
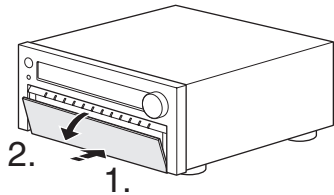

## Display

- 1 Speaker/Channel display: Displays the output channel that corresponds to the selected listening mode.
- 2 Z2/Z3: Lights when the output to Zone 2/Zone 3 is set to on.
- 3 Lights according to the type of input digital signals and the listening mode.
- 4 Stays lit when Music Optimizer is enabled.
- 5 Lights when NET or USB is controlled.
- 6 NET: Stays lit when the "NET" input is selected and the unit is connected to the home network (LAN). It will flash if the connection is not correct.  
USB: Stays lit when the "USB" input is selected and a USB storage device (e.g. USB memory) is connected. It will flash if the connection is not correct.  
HDMI: Stays lit when HDMI signals are input and the HDMI input is selected.  
DIGITAL: Stays lit when digital signals are input and the digital input is selected.  
MUTING: Flashes when MUTING on the remote controller is pressed and audio is temporarily muted.  
ANALOG: Stays lit when analog signals are input and the analog input is selected. Or, it stays lit when HDMI and digital signal inputs are not assigned.  
SLEEP: Stays lit when the sleep timer is set.
- 7 Tuning indicators  
RDS (European model): Stays lit when RDS broadcasting is being received.  
AUTO: Stays lit when the tuning mode is auto.  
TUNED: ► ◀ flashes while tuning is automatically performed. When tuned into a radio station, the "► TUNED ◀" on the display lights.  
FM STEREO: Stays lit when an FM broadcasting is being received.
- 8 BI AMP: Stays lit when "Front Speakers Type" is set to "Bi-Amp".
- 9 Stays lit when headphones are connected.
- 10 Displays various information of the input signals. Pressing DISPLAY displays the type of input digital signals and the listening mode.
- 11 Displays the volume level.

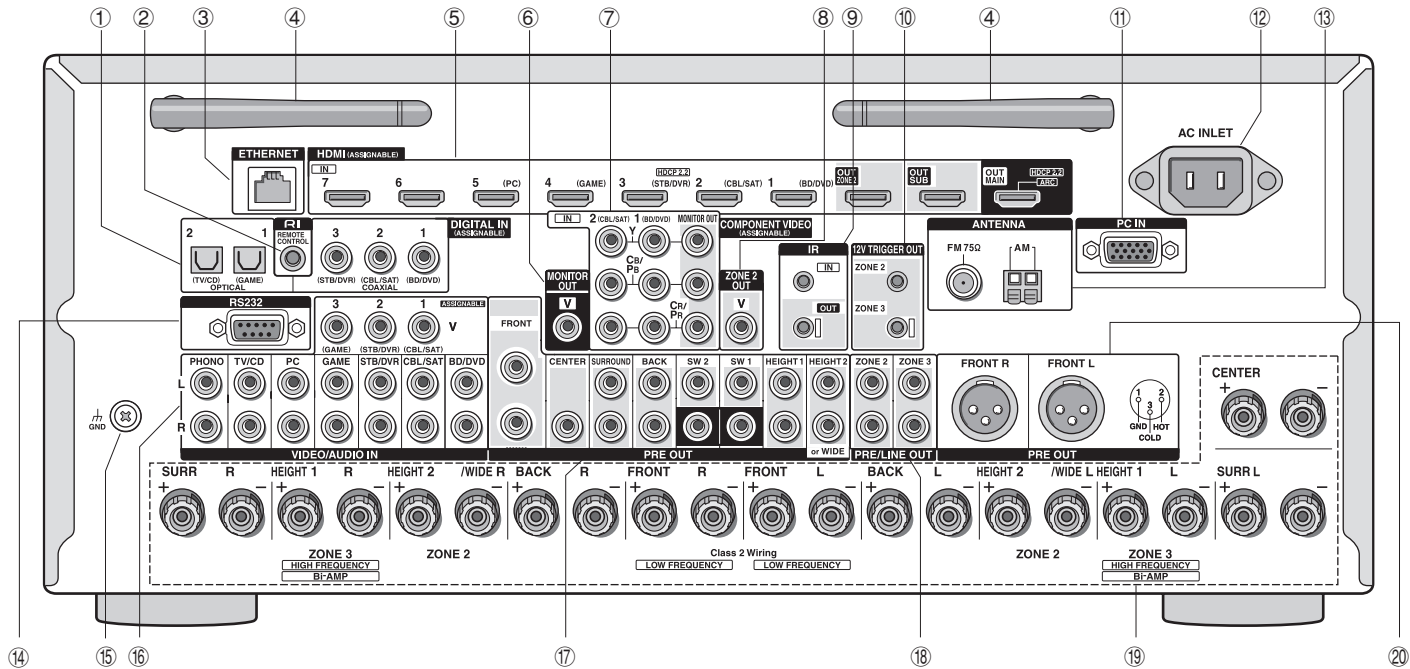

## Rear Panel

- ① **DIGITAL IN COAXIAL/OPTICAL jacks:** Digital audio signals are input.
  - ② **RI REMOTE CONTROL jack:** An Onkyo product with RI jack can be connected and synchronized with this unit.
  - ③ **ETHERNET port:** Used for LAN connection
  - ④ **Wireless antenna:** Used for Wi-Fi connection or when using a Bluetooth-enabled device. Adjust their angles according to the connection status.
- 
- ⑤ **HDMI IN/OUT jacks:** Digital video signals and audio signals are transmitted between the unit and the connected devices.
  - ⑥ **MONITOR OUT V jack:** Video signals are output to the connected monitor or TV.
  - ⑦ **COMPONENT VIDEO IN and OUT jacks:** Component video input/output jacks.
  - ⑧ **ZONE 2 OUT V jack:** Video signals of the player are output to the connected TV in the separate room.
  - ⑨ **IR IN/OUT jack:** Connected to the multiroom remote control kit. (\*)
  - ⑩ **12V TRIGGER OUT ZONE2/ZONE3 jack:** Allows you to connect a device with trigger input jack in a separate room to enable power link operation between the device and the unit. (\*)
  - ⑪ **PC IN jack:** PC is connected via an analog RGB cable.
  - ⑫ **AC INLET:** The power cord is connected.
  - ⑬ **FM ANTENNA jack (75 Ω) and AM ANTENNA terminal:** The supplied antennas are connected.
  - ⑭ **RS232 port:** Connected to the home control system. (\*)
  - ⑮ **GND terminal:** The ground wire of the turntable is connected.
  - ⑯ **Composite video and analog audio jacks:** Analog video signals and audio signals are input.
  - ⑰ **PRE OUT jacks:** A power amplifier or subwoofer with built-in amplifier is connected.
  - ⑱ **ZONE 2 PRE/LINE OUT and ZONE 3 PRE/LINE OUT jacks:** Audio output jacks connected to the pre-main amplifier for multi-zone playback in a separate room.
  - ⑲ **SPEAKERS terminals:** Speakers are connected. To use the Multi-zone function, connect the speakers in the separate room to the ZONE2 speaker terminals.
  - ⑳ **BALANCE PRE OUT jacks:** An amplifier with balance-type XLR input jacks is connected.
- \* Special devices or cable connections are necessary to use the control functions ⑨, ⑩ and ⑭. Contact the specialized stores for more information.



# Troubleshooting

## Before starting the procedure

Problems may be solved by simply turning the power on/off or disconnecting/connecting the power cord, which is easier than working on the connection, setting and operating procedure. Try the simple measures on both the unit and the connected device. If the problem is that the video or audio is not output or the HDMI linked operation does not work, disconnecting/connecting the HDMI cable may solve it. When reconnecting, be careful not to wind the HDMI cable since if wound the HDMI cable may not fit well. After reconnecting, turn off and on the unit and the connected device.

## The AV receiver turns off unexpectedly.

- The AV receiver will automatically enter standby mode when Auto Standby is set and launched.

## There's no sound, or it's very quiet.

- A wrong input selector button has been selected. Select a correct input for the player. Also check that muting is not on.
- Not all listening modes use all speakers.

## There's no picture.

- A wrong input selector button has been selected.
- Video is not displayed if the listening mode is Pure Audio.
- To display video from the connected player on the TV screen while the unit is in standby, you need to enable HDMI Through function.
- When the TV image is blurry or unclear, power cord or connection cables of the unit may have interfered. In that case, keep distance between TV antenna cable and cables of the unit.
- If you connect a player supporting HDCP2.2, be sure to connect it to the HDMI IN3 jack of the unit. At the time, connect the TV to the HDMI OUT MAIN jack.

## HDMI control does not function correctly.

- Set the CEC link function of the unit to on. It is also necessary to make the HDMI linked system setting on the TV. See the TV's instruction manual for details.

## The remote controller does not work.

- Be sure to press RECEIVER first before operating the unit with the remote controller.

## There is no sound for multi-zone function.

- When you connect a CD player or such other player without HDMI output jack, connect it to the analog audio input jacks of the unit. Multi-zone output is not possible if the connection is only with digital optical cable or digital coaxial cable. In case of analog connection, analog audio output setting may be necessary on the player.

## Cannot access to network.

- Try plugging/unplugging the unit or the wireless LAN router or check their power-on status. This will work well in many cases.
- If the desired wireless LAN router is not in the access point list, it may be set to hide SSID or the ANY connection may be off. Change the setting and try again.

## Bluetooth

- Try plugging/unplugging the unit and the Bluetooth-enabled player. After that, check that the Bluetooth function is enabled on the Bluetooth-enabled device and the connection with the unit has been established.

## Resetting the unit

Resetting the unit to the status at the time of shipment may solve the problem. If the measures above do not solve the problem, reset the unit with the following procedure. If you reset the unit status, your preferences will be reset to the defaults. Note them down before starting reset.

### ● How to reset:

1. While holding down CBL/SAT on the main unit (note that step 2 must be performed with this button pressed down)
2. Press ON/STANDBY on the main unit ("Clear" appears on the display and the unit returns to standby)

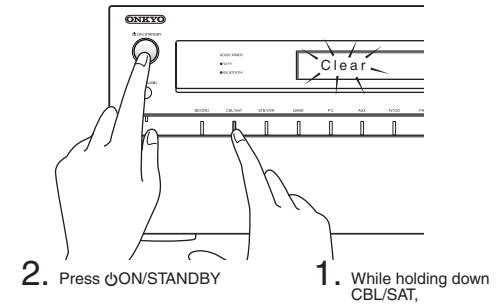

### ● How to reset the remote controller:

1. While holding down RECEIVER on the remote controller, press HOME (about 3 seconds) until RECEIVER lights.
2. Within 30 seconds, press RECEIVER again.

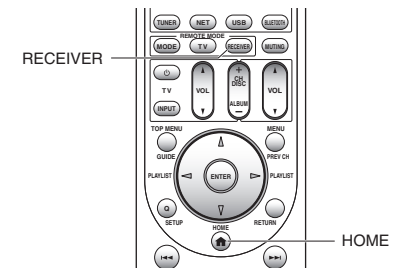

# Specifications

## Amplifier Section

### Rated Output Power

**All channels: 135 watts minimum continuous power per channel, 8 ohm loads, 2 channels driven from 20 Hz to 20 kHz, with a maximum total harmonic distortion of 0.08% (FTC) (North American)**

9 ch x 185 W at 6 ohms, 1 kHz, 1 ch driven of 1% (IEC) (Others)

### Maximum Effective Output Power

9 ch x 230 W at 6 ohms, 1 kHz, 1 ch driven (JEITA) (Asian)

### Dynamic Power (\*)

\* IEC60268-Short-term maximum output power

300 W (3 Ω, Front)

250 W (4 Ω, Front)

150 W (8 Ω, Front)

### THD+N (Total Harmonic Distortion+Noise)

0.08% (20 Hz - 20 kHz, half power)

### Damping Factor

60 (Front, 1 kHz, 8 Ω)

### Input Sensitivity and Impedance (Unbalance)

200 mV/47 kΩ (LINE)

2.5 mV/47 kΩ (PHONO MM)

### Rated RCA Output Level and Impedance

200 mV/470 Ω (PRE OUT)

### Maximum RCA Output Level and Impedance

4.6 V/470 Ω (PRE OUT)

### Rated XLR Output Level and Impedance

400 mV/470 Ω (PRE OUT)

### Maximum XLR Output Level and Impedance

9.2 V/470 Ω (PRE OUT)

### Phono Overload

70 mV (MM 1 kHz 0.5% Direct)

### Frequency Response

5 Hz - 100 kHz/+1 dB, -3 dB (Direct mode)

### Tone Control Characteristics

±10 dB, 50 Hz (BASS)

±10 dB, 20 kHz (TREBLE)

### Signal to Noise Ratio

110 dB (LINE, IHF-A)

80 dB (PHONO MM, IHF-A)

### Speaker Impedance

4 Ω - 16 Ω or 6 Ω - 16 Ω

## Video Section

### Input Sensitivity/Output Level and Impedance

1 Vp-p/75 Ω (Component Y)

0.7 Vp-p/75 Ω (Component P<sub>B</sub>/C<sub>B</sub>, P<sub>R</sub>/C<sub>R</sub>)

1 Vp-p/75 Ω (Composite)

### Component Video Frequency Response

5 Hz - 100 MHz/+0 dB, -3 dB

## Tuner Section

### FM Tuning Frequency Range

87.5 MHz - 107.9 MHz (North American)

87.5 MHz - 108.0 MHz, RDS (Others)

### AM Tuning Frequency Range

522/530 kHz - 1611/1710 kHz

### Preset Channel

40

## Network Section

### Ethernet LAN

10BASE-T/100BASE-TX

### Wireless LAN

IEEE 802.11 b/g/n standard

(Wi-Fi® standard)

2.4 GHz band: 1 - 11 ch (North American)

10 - 11 ch (Spain)

10 - 13 ch (France)

1 - 13 ch (Others)

(Wi-Fi® standard)

## Bluetooth Section

### Communication system

Bluetooth Specification version 2.1 +EDR (Enhanced Data Rate)

### Maximum communication range

Line of sight approx. 15 m (\*)

### Frequency band

2.4 GHz band (2.4000 GHz - 2.4835 GHz)

### Modulation method

FHSS (Freq Hopping Spread Spectrum)

### Compatible Bluetooth profiles

A2DP 1.2 (Advanced Audio Distribution Profile)

AVRCP 1.3 (Audio Video Remote Control Profile)

### Supported Codecs

SBC

### Transmission range (A2DP)

20 Hz - 20,000 Hz (Sampling frequency 44.1 kHz)

\* The actual range will vary depending on factors such as obstacles between devices, magnetic fields around a microwave oven, static electricity, cordless phone, reception sensitivity, antenna's performance, operating system, software application, etc.

## General

### Power Supply

AC 120 V, 60 Hz (North American)

AC 220 - 240 V, 50/60 Hz (Others)

### Power Consumption

9.6 A (North American)

955 W (Others)

0.1 W (Stand-by, North American)

0.12 W (Stand-by, Others)

125 W (No-sound)

### Dimensions (W x H x D)

435 mm x 199 mm x 466.5 mm

17-1/8" x 7-13/16" x 18-3/8"

### Weight

20.5 kg (45.2 lbs.)

## ● HDMI

### Input

IN1 (BD/DVD), IN2 (CBL/SAT), IN3 (STB/DVR, HDCP2.2), IN4 (GAME),

IN5 (PC), IN6, IN7, AUX INPUT (HDMI/MHL) (front)

### Output

OUT MAIN (ARC, HDCP2.2), OUT SUB, OUT ZONE2

### Video Resolution

Pass through: 4K 60Hz (YCbCr 4:2:0)

Upscaling: 4K 30Hz

### Audio Format

Dolby Atmos, DTS-HD Master Audio, DTS-HD High Resolution Audio,

Dolby TrueHD, Dolby Digital Plus, DSD, Multichannel PCM

### Supported

3D, Audio Return Channel, DeepColor, x.v.Color, LipSync, CEC (RIHD),

4K (Upscaling and Passthrough)

## ● Video Inputs

### Component

IN1 (BD/DVD), IN2 (CBL/SAT)

### Composite

IN1 (CBL/SAT), IN2 (STB/DVR), IN3 (GAME), AUX INPUT (front)

### Analog RGB inputs

PC IN

## ● Video Outputs

### Component

MONITOR OUT

### Composite

MONITOR OUT, ZONE2 OUT

## ● Audio Inputs

### Digital

OPTICAL 1 (GAME), 2 (TV/CD), AUX INPUT DIGITAL (front)

COAXIAL 1 (BD/DVD), 2 (CBL/SAT), 3 (STB/DVR)

### Analog

BD/DVD, CBL/SAT, STB/DVR, GAME, PC, TV/CD, PHONO, AUX INPUT (front)

## ● Audio Outputs

### Analog

PRE/LINE OUT ZONE2, ZONE3

### Balance Pre Outputs

PREOUT FRONT L, FRONT R

### Analog Multichannel Pre Outputs

FRONT L/R, CENTER, SURROUND L/R, BACK L/R, HEIGHT 1 L/R,

HEIGHT 2 or WIDE L/R, SW1 x 2, SW2 x 2

### Speaker Outputs

FRONT L/R, CENTER, SURR L/R, BACK L/R, HEIGHT 1 (or ZONE3 or

Bi-AMP) L/R, HEIGHT 2/WIDE (or ZONE2) L/R

### Phones

PHONES (Front, ø 6.3)

## ● Others

### Setup Mic 1 (Front)

RS232 1

Ethernet 1

IR IN 1/OUT 1

12V TRIGGER OUT 2 (ZONE2/ZONE3)

USB 1 (Front)

RI 1

Specifications and features are subject to change without notice.

# License and Trademark Information



Manufactured under license from Dolby Laboratories. Dolby, Dolby Atmos, Dolby Surround, Surround EX and the double-D symbol are trademarks of Dolby Laboratories.



For DTS patents, see <http://patents.dts.com>. Manufactured under license from DTS Licensing Limited. DTS, DTS-HD, the Symbol, & DTS and the Symbol together are registered trademarks, and DTS-HD Master Audio and DTS NeoX | 11.1 are trademarks of DTS, Inc. © DTS, Inc. All Rights Reserved.



Qdeo and QuietVideo are trademarks of Marvell or its affiliates.

Re-Equalization and the "Re-EQ" logo are trademarks of THX Ltd.



Manufactured under license from THX Ltd. THX and the THX logo are registered in the U.S. and other jurisdictions. All rights reserved. Surround EX is a trademark of Dolby Laboratories. Used with permission. U.S. Pat. nos. 7,254,239 & 7,593,533 & 7,974,425 & 8,452,028 & 8,509,457 Taiwan Pat. I238671 European Pat. 1,360,874

## THX Select2 Plus

Before any home theater component can be THX Select2 Plus certified, it must pass a rigorous series of quality and performance tests. Only then can a product feature the THX Select2 Plus logo, which is your guarantee that the Home Theater products you purchase will give you superb performance for many years to come. THX Select2 Plus requirements define hundreds of parameters, including power amplifier performance, and pre-amplifier performance and operation for both digital and analog domains. THX Select2 Plus receivers also feature proprietary THX technologies (e.g., THX Mode) which accurately translate movie soundtracks for home theater playback.

AccuEQ, Music Optimizer, RIHD and WRAT are trademarks of Onkyo Corporation.

"RIHD" and "RIHD (logo)" are trademarks of Onkyo Corporation.



The terms HDMI and HDMI High-Definition Multimedia Interface, and the HDMI Logo are trademarks or registered trademarks of HDMI Licensing LLC in the United States and other countries.



The Wi-Fi CERTIFIED® Logo is a certification mark of the Wi-Fi Alliance. Wi-Fi certified® logo shows international association certifying interoperability "Wi-Fi alliance" ensures the product has passed the test for compatibility with other Wi-Fi certified equipment.



The Bluetooth® word mark and logos are registered trademarks owned by Bluetooth SIG, Inc. and any use of such marks by Onkyo is under license. Other trademarks and trade names are those of their respective owners. Onkyo does not guarantee Bluetooth compatibility between the AV receiver and all Bluetooth-enabled devices. For compatibility between the AV receiver and another device with Bluetooth technology, consult the device's documentation and dealer. In some countries, there may be restrictions on using Bluetooth devices. Check with your local authorities.



"MHL, the MHL Logo, and Mobile High-Definition Link are trademarks or registered trademarks of MHL LLC in the United States and other counties."

InstaPrevue and the InstaPrevue logo are trademarks or registered trademarks of Silicon Image, Inc. in the United States and other countries.

Apple, iPod and iPhone are trademarks of Apple Inc., registered in the U.S. and other countries.

Apple TV is a trademark of Apple Inc., registered in the U.S. and other countries.



SIRIUS, XM and all related marks and logos are trademarks of Sirius XM Radio Inc. and its subsidiaries. All rights reserved.

DLNA®, the DLNA Logo and DLNA CERTIFIED® are trademarks, service marks, or certification marks of the Digital Living Network Alliance.

This product is protected by certain intellectual property rights of Microsoft. Use or distribution of such technology outside of this product is prohibited without a license from Microsoft.

Windows and the Windows logo are trademarks of the Microsoft group of companies.

QR Code is a registered trademark of DENSO WAVE INCORPORATED.

Safari is a trademark or registered trademark of Apple Computer, Inc. in the United States.

"x.v.Color" is a trademark of Sony Corporation.

MPEG Layer-3 audio coding technology licensed from Fraunhofer IIS and Thomson.

"Xantech" is a registered trademark of Xantech Corporation.

"Niles" is a registered trademark of Niles Audio Corporation.

"All other trademarks are the property of their respective owners."

## DISCLAIMER

Through this device you are able to link to other services or websites which are not under the control of any company which has designed, manufactured or distributed/have distributed this device, and its affiliates (collectively, "Company"). We have no control over the nature, content and availability of those services. The inclusion of any links does not necessarily imply a recommendation or endorse the views expressed within them.

All information, content and services available through this device belong to third parties and are protected by copyright, patent, trademark and/or other intellectual property laws of applicable countries.

The information, content and services provided through this device are for your personal, noncommercial use only. Any information, content or services may not be used in any manner other than previously approved by the appropriate content owner or service provider.

You may not modify, copy, republish, translate, exploit, create derivative works, upload, post, transmit, sell or distribute in any manner any information, content or services available through this device, unless expressly permitted by the appropriate copyright, patent, trademark and/or other intellectual property owner, including, without limitation, content owner or service provider.

THE CONTENT AND SERVICES AVAILABLE THROUGH THIS DEVICE ARE PROVIDED "AS IS".

COMPANY DOES NOT WARRANT INFORMATION, CONTENT OR SERVICES SO PROVIDED, EITHER EXPRESSLY OR IMPLIEDLY, FOR ANY PURPOSE.

COMPANY EXPRESSLY DISCLAIMS ANY WARRANTIES, EXPRESS OR IMPLIED, INCLUDING BUT NOT LIMITED TO, WARRANTIES OF TITLE, NON-INFRINGEMENT, MERCHANTABILITY OR FITNESS FOR A PARTICULAR PURPOSE.

Company makes no representation or warranty of any kind, express or implied, about the completeness, accuracy, validity, legality, reliability, suitability or availability with respect to the information, content or services available through this device. Company shall not be liable, whether in contract or tort, including negligence and strict liability, for any direct, indirect, special, incidental or consequential damages or any other damages arising out of, or in connection with, any information contained in, or as a result of the use of any content or service by you or any third party, even if Company has been advised of the possibility of such damages, nor shall Company be liable for any third party claims against users of this device or any third party.

In no event shall Company be responsible nor liable for, without limiting the generality of the foregoing, any interruption or suspension of any information, content or service available through this device. Company is neither responsible nor liable for customer service related to the information, content and services available through this device. Any question or request for service relating to the information, content or services should be made directly to the appropriate content owners and services providers.

## Precautions

## For European Models

### Declaration of Conformity

We declare, under our sole responsibility, that this product complies with the standards:

- Safety
- Limits and methods of measurement of radio disturbance characteristics
- Limits for harmonic current emissions
- Limitation of voltage changes, voltage fluctuations and flicker
- RoHS Directive, 2011/65/EU
- Hereby, Onkyo Corporation, declares that this TX-NR1030 is in compliance with the essential requirements and other relevant provisions of Directive 1999/5/EC.
- С настоящето, Onkyo Corporation, декларира, че TX-NR1030 е в съответствие със съществените изисквания и другите приложими разпоредби на Директива 1999/5/EC.
- Onkyo Corporation tímto prohlašuje, že TX-NR1030 splňuje základní požadavky a všechna příslušná ustanovení Směrnice 1999/5/ES.
- Undertegnede Onkyo Corporation erklærer herved, at følgende udstyr TX-NR1030 overholder de væsentlige krav og øvrige relevante krav i direktiv 1999/5/EF.
- Hiermit erklärt Onkyo Corporation, dass sich das Gerät TX-NR1030 in Übereinstimmung mit den grundlegenden Anforderungen und den übrigen einschlägigen Bestimmungen der Richtlinie 1999/5/EG befindet.



- Káesolevaga kinnitab Onkyo Corporation seadmé TX-NR1030 vastavust direktiivi 1999/5/EÜ põhinõuetele ja nimetatud direktiivist tulenevatele teistele asjakohastele sätetele.
- ΜΕ ΤΗΝ ΠΑΡΟΥΣΑ Ο ΚΑΤΑΣΚΕΥΑΣΤΗΣ Onkyo Corporation ΔΗΛΩΝΕΙ ΟΤΙ ΤΟ TX-NR1030 ΣΥΜΜΟΡΦΩΝΕΤΑΙ ΠΡΟΣ ΤΙΣ ΟΥΣΙΩΔΕΙΣ ΑΠΑΙΤΗΣΕΙΣ ΚΑΙ ΤΙΣ ΛΟΙΠΕΣ ΣΧΕΤΙΚΕΣ ΔΙΑΤΑΞΕΙΣ ΤΗΣ ΟΔΗΓΙΑΣ 1999/5/ΕΚ
- Por la presente, Onkyo Corporation, declara que este TX-NR1030 cumple con los requisitos esenciales y otras exigencias relevantes de la Directiva 1999/5/EC.
- Par la présente, Onkyo Corporation déclare que l'appareil TX-NR1030 est conforme aux exigences essentielles et aux autres dispositions pertinentes de la directive 1999/5/CE.
- Con la presente Onkyo Corporation dichiara che questo TX-NR1030 è conforme ai requisiti essenziali ed alle altre disposizioni pertinenti stabilite dalla direttiva 1999/5/CE.
- Ar šo Onkyo Corporation deklarē, ka TX-NR1030 atbilst Direktīvas 1999/5/EK būtiskajām prasībām un citiem ar to saistītajiem noteikumiem.
- Šiuo Onkyo Corporation deklaruoja, kad šis TX-NR1030 atitinka esminius reikalavimus ir kitas 1999/5/EB Direktivos nuostatas.
- A Onkyo Corporation ezzennel kijelenti, hogy a TX-NR1030 típusú berendezés teljesíti az alapvető követelményeket és más 1999/5/EK irányelvben meghatározott vonatkozó rendelkezéseket.
- Hierbij verklaart Onkyo Corporation dat het toestel I TX-NR1030 in overeenstemming is met de essentiële eisen en de andere relevante bepalingen van richtlijn 1999/5/EG.
- Niniejszym Onkyo Corporation deklaruje że TX-NR1030 jest zgodny z zasadniczymi wymaganiami i innymi właściwymi postanowieniami Dyrektywy 1999/5/EC.
- Eu, Onkyo Corporation, declaro que o TX-NR1030 cumpre os requisitos essenciais e outras provisões relevantes da Directiva 1999/5/EC.
- Prin prezenta, Onkyo Corporation, declară că aparatul TX-NR1030 este în conformitate cu cerințele esențiale și cu alte prevederi pertinente ale Directivei 1999/5/CE.
- Onkyo Corporation tímto vyhlasuje, že TX-NR1030 a splnía základné požiadavky a všetky príslušné ustanovenia Smernice 1999/5/ES.
- Onkyo Corporation izjavlja, da je ta TX-NR1030 v skladu z bistvenimi zahtevami in drugimi relevantnimi določili direktive 1999/5/ES.
- Onkyo Corporation vakuuttaa täten että TX-NR1030 tyyppinen laite on direktiivin 1999/5/EY oleellisten vaatimusten ja sitä koskevien direktiivin muiden ehtojen mukainen.
- Härmed förklarar Onkyo Corporation att denna TX-NR1030 följer de väsentliga kraven och andra relevanta stadgar i Direktiv 1999/5/EC.
- Hér með lýsir Onkyo Corporation því yfir að varan TX-NR1030 er í samræmi við grunnkröfur og aðrar kröfur sem gerðar eru í tilskipun 1999/5/EC.
- Onkyo Corporation erklærer herved at denne TX-NR1030 er i overensstemmelse med væsentlige krav og andre relevante bestemmelser i direktiv 1999/5/EC.
- Ovime Onkyo Corporation, potvrđuje da je TX-NR1030 u suglasnosti sa osnovnim zahtjevima i ostalim relevantnim odredbama Direktive 1999/5/EC.

# ONKYO

### Onkyo Corporation

Kitahama Chuo Bldg, 2-2-22 Kitahama, Chuo-ku,  
OSAKA 541-0041, JAPAN  
<http://www.onkyo.com/>

### The Americas

#### Onkyo U.S.A. Corporation

18 Park Way, Upper Saddle River, N.J. 07458, U.S.A.  
For Dealer, Service, Order and all other Business Inquiries:  
Tel: 201-785-2600 Fax: 201-785-2650  
<http://www.us.onkyo.com/>

For Product Support Team Only:  
1-800-229-1687

### Europe

#### Onkyo Europe Electronics GmbH

Liegnitzerstrasse 6, 82194 Groebenzell, GERMANY  
Tel: +49-8142-4401-0 Fax: +49-8142-4208-213  
<http://www.eu.onkyo.com/>

#### Onkyo Europe Electronics GmbH (UK Branch)

Meridian House, Ground floor, 69 - 71 Clarendon Road,  
Watford, Hertfordshire, WD17 1DS, United Kingdom  
Tel: +44 (0)8712-00-19-96 Fax: +44 (0)8712-00-19-95

### China

#### Onkyo China Limited (Hong Kong)

Unit 1033, 10/F, Star House, No 3, Salisbury Road,  
Tsim Sha Tsui Kowloon, Hong Kong.  
Tel: 852-2429-3118 Fax: 852-2428-9039  
<http://www.hk.onkyo.com/>

### Onkyo China PRC (Mainland)

1301, 555 Tower, No.555 West Nanjing Road, Jing'an District,  
Shanghai, China 200041,  
Tel: 86-21-52131366 Fax: 86-21-52130396  
<http://www.cn.onkyo.com/>

### Asia, Oceania, Middle East, Africa

Please contact an Onkyo distributor referring to Onkyo  
SUPPORT site.  
<http://www.intl.onkyo.com/support/>

The above-mentioned information is subject to change  
without prior notice.  
Visit the Onkyo web site for the latest update.

SN 29401673

(C) Copyright 2014 Onkyo Corporation Japan. All rights reserved.

D1406-0



\* 2 9 4 0 1 6 7 3 \*

## ■ Support for Spotify Connect

Spotify Connect can be supported by updating the unit's firmware. Simply click the Connect icon and select the unit on the playback screen of Spotify application to enjoy high quality music streaming. To enable Spotify Connect, install the Spotify application on your smartphone or tablet first. Then, create a Spotify premium account.

\* The Spotify software is subject to third party licenses found here:  
[www.spotify.com/connect/third-party-licenses](http://www.spotify.com/connect/third-party-licenses)

## Notes for using multi-zone function

- To enjoy Spotify music in a separate room, select "NET" as the input of the separate room.
- Volume adjustment with the Spotify application is possible only for the equipment connected to the ZONE2/3 speaker terminals (compatible model only). If any other terminal is used for connection, adjust the volume on the audio equipment placed in a separate room.
- To enjoy Spotify music in the main room after playing Spotify in a separate room, select "NET" as the input of the main room.

## Auto Power On

- Turning network standby on allows you to use the Auto Power On function when using the Spotify application.

## ■ Support pour Spotify Connect

Spotify Connect peut être pris en charge par la mise à jour du logiciel de l'unité. Cliquez simplement sur l'icône Connect et sélectionnez l'unité sur l'écran de lecture de l'application Spotify pour profiter de la diffusion audio de haute qualité. Pour activer Spotify Connect, installez l'application Spotify sur votre smartphone ou tablette en premier. Puis, créez un compte premium Spotify.

\* Le logiciel Spotify est soumis à des licences de tiers que vous trouverez ici :  
[www.spotify.com/connect/third-party-licenses](http://www.spotify.com/connect/third-party-licenses)

## Remarques concernant la fonction multizone

- Pour profiter de la musique Spotify dans une pièce séparée, sélectionnez « NET » comme entrée de la pièce séparée.
- Le réglage du volume avec l'application Spotify n'est possible que pour l'équipement connecté aux bornes d'enceintes ZONE2/3 (modèle compatible seulement).

Si un autre type de borne est utilisé pour la connexion, réglez le volume sur l'équipement audio placé dans une pièce séparée.

- Afin de profiter de la musique Spotify dans la pièce principale après la lecture de Spotify dans une pièce séparée, sélectionnez « NET » comme entrée de la pièce principale.

## Mise sous tension automatique

- La mise en veille du réseau vous permet d'utiliser la fonction de mise sous tension automatique lors de l'utilisation de l'application Spotify.

## ■ Compatibilidad con Spotify Connect

Spotify Connect será compatible mediante la actualización del firmware de la unidad. Simplemente haga clic en el icono Connect y seleccione la unidad en la pantalla de reproducción de la aplicación Spotify para disfrutar de transmisión de música de alta calidad. Para habilitar Spotify Connect, instale primeramente la aplicación Spotify en su teléfono inteligente o tableta. A continuación, cree una cuenta Spotify premium.

\* El software de Spotify está protegido por licencias de terceros que encontrará en:  
[www.spotify.com/connect/third-party-licenses](http://www.spotify.com/connect/third-party-licenses)

## Notas sobre el uso de función multizona

- Para disfrutar de la música de Spotify en otra habitación, seleccione "NET" como la entrada de dicha habitación.
- Con la aplicación Spotify podrá ajustar el volumen solamente del equipo conectado a los terminales del altavoz ZONE2/3 (únicamente modelos compatibles). Si usa cualquier otro terminal para la conexión, ajuste el volumen en el equipo de audio ubicado en dicha habitación independiente.
- Para disfrutar de la música de Spotify en la habitación principal después de reproducirla en otra habitación Spotify, seleccione "NET" como la entrada de la habitación principal.

## Activación automática

- Activar el modo de espera de red le permite usar la función de activación automática al utilizar la aplicación Spotify.

## ■ Supporto per Spotify Connect

Spotify Connect può essere supportato tramite l'aggiornamento del firmware dell'unità. È sufficiente cliccare sull'icona Connect e selezionare l'unità sulla schermata di riproduzione dell'applicazione Spotify per fruire di streaming di musica ad alta qualità. Per abilitare Spotify Connect, installare anzitutto l'applicazione Spotify sul proprio smartphone o tablet. Quindi, creare un account premium Spotify.

\* Il software Spotify è soggetto a licenze di terze parti presenti all'indirizzo:  
[www.spotify.com/connect/third-party-licenses](http://www.spotify.com/connect/third-party-licenses)

## Note per l'utilizzo della funzione multi-zona

- Per fruire di musica Spotify in una stanza separata, selezionare "NET" come ingresso della stanza separata.
- La regolazione del volume con l'applicazione Spotify è possibile solo per l'apparecchiatura collegata ai terminali dell'altoparlante ZONE2/3 (solo modello compatibile). Se viene utilizzato qualsiasi altro terminale per il collegamento, regolare il volume sull'apparecchiatura audio posizionata in una stanza separata.
- Per fruire di musica Spotify nella stanza principale dopo aver riprodotto Spotify in una stanza separata, selezionare "NET" come ingresso della stanza principale.

## Accensione automatica

- L'attivazione dello standby di rete consente di utilizzare la funzione di accensione automatica quando si utilizza l'applicazione Spotify.

D1410-0

SN 29402014

(C) Copyright 2014 Onkyo Corporation Japan. All rights reserved.



## ■ Unterstützung für Spotify Connect

---

Spotify Connect kann durch Aktualisierung der Firmware des Geräts unterstützt werden. Klicken Sie einfach auf das Symbol Connect und wählen Sie das Gerät auf dem Wiedergabe-Bildschirm der Anwendung Spotify, um hochwertiges Musik-Streaming zu genießen. Zur Aktivierung von Spotify Connect, installieren Sie die Anwendung Spotify zuerst auf Ihrem Smartphone oder Tablet. Erstellen Sie dann einen Spotify Premium-Account.

\* Die Software Spotify benötigt Lizenzen dritter Parteien, die Sie hier finden:  
[www.spotify.com/connect/third-party-licenses](http://www.spotify.com/connect/third-party-licenses)

## Hinweise zur Verwendung der Multizonenfunktion

- Zum Genuss von Spotify Musik in einem anderen Raum, wählen Sie „NET“ als Eingang für den anderen Raum aus.
- Lautstärken-Einstellung mit der Anwendung Spotify ist nur für Ausrüstung möglich, die mit den Lautsprecheranschlüssen ZONE2/3 verbunden ist (nur kompatibles Modell). Wird für die Verbindung ein anderer Anschluss verwendet, passen Sie die Lautstärke an der Audio-Ausrüstung an, die in einem anderen Raum platziert ist.
- Zum Genuss von Spotify Musik im Hauptraum nach dem Abspielen von Spotify in einem anderen Raum, wählen Sie „NET“ als Eingang für den Hauptraum aus.

## Auto Power Ein

- Einschalten von Netzwerk-Standby ermöglicht Ihnen die Verwendung der Auto Power Ein-Funktion, wenn Sie die Anwendung Spotify verwenden.

## ■ Ondersteuning voor Spotify Connect

---

Spotify Connect kan worden ondersteund door de firmware van het toestel bij te werken. Klik simpelweg op het pictogram Connect en selecteer het toestel op het weergavescherm van de Spotify-toepassing om te genieten van hoogwaardige muziekstreaming. Om Spotify Connect in te schakelen, installeert u eerst de Spotify-toepassing op uw smartphone of tablet. Maak vervolgens een premium account voor Spotify.

\* De software van Spotify is onderworpen aan licenties van derde partijen die u hier terugvindt:  
[www.spotify.com/connect/third-party-licenses](http://www.spotify.com/connect/third-party-licenses)

## Opmerkingen voor gebruik van de multi-zonefunctie

- Om te genieten van muziek van Spotify in een aparte ruimte, selecteert u „NET“ als de invoer van de aparte ruimte.
- Volumeregeling met de Spotify-toepassing is alleen mogelijk voor de apparatuur verbonden met de ZONE2/3-luidspreker aansluitingen (alleen compatibel model). Als een andere aansluiting wordt gebruikt voor de verbinding, regel het volume dan op de audioapparatuur in een aparte ruimte.
- Om te genieten van muziek van Spotify in de hoofdruimte na het afspelen van Spotify in een aparte ruimte, selecteert u „NET“ als de invoer van de hoofdruimte.

## Automatisch Inschakelen Aan

- Als u het netwerk in stand-by zet, kunt u de functie Automatisch Inschakelen Aan gebruiken wanneer u de Spotify-toepassing gebruikt.

## ■ Stöd för Spotify Connect

---

Spotify Connect stöds genom att uppdatera enhetens firmware. Klicka på Connect-ikonen och välj enheten på Spotify-applikationens uppspelningsskärm för att njuta av högkvalitativ musik-streaming. För att aktivera Spotify Connect, måste du först installera Spotify-applikationen på din smartphone eller surfplatta. Skapa sedan ett Spotify-premiumkonto.

\* Spotify-programvaran omfattas av tredjepartslicenser som kan hittas här:  
[www.spotify.com/connect/third-party-licenses](http://www.spotify.com/connect/third-party-licenses)

## Anmärkningar för användning av multizonfunktionen

- För att uppleva Spotify-musik i ett annat rum, välj ”NET” som inmatning för det andra rummet.
- Justering av volymen för Spotify-applikationen är endast möjlig för utrustningen som är ansluten till ZONE2/3-högtalarkontakterna (endast kompatibla modeller). Om någon annan kontakt används för anslutningen, justera volymen på ljudutrustningen i det andra rummet.
- För att uppleva Spotify-musik i huvudrummet efter att du har spelat Spotify i ett annat rum, välj ”NET” som ingångskälla för huvudrummet.

## Automatiskt strömpåslag

- Genom att slå på nätverks-standby kan du använda funktionen för automatiskt strömpåslag när du använder Spotify-applikationen.

## ■ Spotify Connect -tuki

---

Spotify Connect voidaan tukea päivittämällä laitteen ohjelmisto. Napsauta Connect-kuvaketta ja valitse laite Spotify-sovelluksen toistonäytössä nauttiaksesi korkealaatuisesta musiikin suoratoistosta. Ota Spotify Connect käyttöön asentamalla Spotify-sovellus ensin älypuhelimellesi tai tablettiisi. Luo sitten Spotify Premium -tili.

\* Spotify-ohjelmistoon sovelletaan kolmannen osapuolen lisenssejä, jotka löytyvät täältä:  
[www.spotify.com/connect/third-party-licenses](http://www.spotify.com/connect/third-party-licenses)

## Huomautuksia monivyöhyketoiminnon käytöstä

- Nauti Spotify-musiikista erillisessä huoneessa valitsemalla erillisen huoneen tulolähteeksi ”NET”.
- Äänenvoimakkuuden säätö Spotify-sovelluksella on mahdollista vain laitteella, joka on kytketty ZONE2/3-kaiuttimiliitäntään (vain yhteensopiva malli). Jos jotain muuta kaiutinpäätettä käytetään kytkemisessä, säädä äänenvoimakkuutta äänentoistolaitteesta joka sijaitsee erillisessä huoneessa.
- Kun haluat nauttia Spotify-musiikista päähuoneessa sen jälkeen kun Spotify-musiikkia on toistettu erillisessä huoneessa, valitse ”NET” tulolähteeksi päähuoneessa.

## Automaattinen virta päälle -toiminto

- Kytkeällä verkon valmiustilan päälle voit käyttää automaattista virta päälle -toimintoa, kun käytät Spotify-sovellusta.