

**ONKYO®**

**Stereo Receiver**

***TX-8255***

**Instruction Manual**

Thank you for purchasing an Onkyo Stereo Receiver. Please read this manual thoroughly before making connections and plugging in the unit. Following the instructions in this manual will enable you to obtain optimum performance and listening enjoyment from your new Stereo Receiver. Please retain this manual for future reference.

## Contents

Introduction ..... 2

Connections ..... 12

Enjoying Audio Sources..... 19

### Others

Troubleshooting ..... 31

Specifications ..... 33

## WARNING:

TO REDUCE THE RISK OF FIRE OR ELECTRIC SHOCK, DO NOT EXPOSE THIS APPARATUS TO RAIN OR MOISTURE.

## CAUTION:

TO REDUCE THE RISK OF ELECTRIC SHOCK, DO NOT REMOVE COVER (OR BACK). NO USER-SERVICEABLE PARTS INSIDE. REFER SERVICING TO QUALIFIED SERVICE PERSONNEL.



**WARNING**  
RISK OF ELECTRIC SHOCK  
DO NOT OPEN

**AVIS**  
RISQUE DE CHOC ELECTRIQUE  
NE PAS OUVRIIR



The lightning flash with arrowhead symbol, within an equilateral triangle, is intended to alert the user to the presence of uninsulated “dangerous voltage” within the product’s enclosure that may be of sufficient magnitude to constitute a risk of electric shock to persons.



The exclamation point within an equilateral triangle is intended to alert the user to the presence of important operating and maintenance (servicing) instructions in the literature accompanying the appliance.

## Important Safety Instructions

1. Read these instructions.
2. Keep these instructions.
3. Heed all warnings.
4. Follow all instructions.
5. Do not use this apparatus near water.
6. Clean only with dry cloth.
7. Do not block any ventilation openings. Install in accordance with the manufacturer’s instructions.
8. Do not install near any heat sources such as radiators, heat registers, stoves, or other apparatus (including amplifiers) that produce heat.
9. Do not defeat the safety purpose of the polarized or grounding-type plug. A polarized plug has two blades with one wider than the other. A grounding type plug has two blades and a third grounding prong. The wide blade or the third prong are provided for your safety. If the provided plug does not fit into your outlet, consult an electrician for replacement of the obsolete outlet.
10. Protect the power cord from being walked on or pinched particularly at plugs, convenience receptacles, and the point where they exit from the apparatus.
11. Only use attachments/accessories specified by the manufacturer.
12. Use only with the cart, stand, tripod, bracket, or table specified by the manufacturer, or sold with the apparatus. When a cart is used, use caution when moving the cart/apparatus combination to avoid injury from tip-over.  

PORTABLE CART WARNING  
S3125A
13. Unplug this apparatus during lightning storms or when unused for long periods of time.
14. Refer all servicing to qualified service personnel. Servicing is required when the apparatus has been damaged in any way, such as power-supply cord or plug is damaged, liquid has been spilled or objects have fallen into the apparatus, the apparatus has been exposed to rain or moisture, does not operate normally, or has been dropped.
15. Damage Requiring Service  
Unplug the apparatus from the wall outlet and refer servicing to qualified service personnel under the following conditions:
  - A. When the power-supply cord or plug is damaged,
  - B. If liquid has been spilled, or objects have fallen into the apparatus,
  - C. If the apparatus has been exposed to rain or water,
  - D. If the apparatus does not operate normally by following the operating instructions. Adjust only those controls that are covered by the operating instructions as an improper adjustment of other controls may result in damage and will often require extensive work by a qualified technician to restore the apparatus to its normal operation,
  - E. If the apparatus has been dropped or damaged in any way, and
  - F. When the apparatus exhibits a distinct change in performance this indicates a need for service.
16. Object and Liquid Entry  
Never push objects of any kind into the apparatus through openings as they may touch dangerous voltage points or short-out parts that could result in a fire or electric shock.  
The apparatus shall not be exposed to dripping or splashing and no objects filled with liquids, such as vases shall be placed on the apparatus.  
Don’t put candles or other burning objects on top of this unit.
17. Batteries  
Always consider the environmental issues and follow local regulations when disposing of batteries.
18. If you install the apparatus in a built-in installation, such as a bookcase or rack, ensure that there is adequate ventilation.  
Leave 20 cm (8”) of free space at the top and sides and 10 cm (4”) at the rear. The rear edge of the shelf or board above the apparatus shall be set 10 cm (4”) away from the rear panel or wall, creating a flue-like gap for warm air to escape.

# Precautions

---

1. **Recording Copyright**—Unless it's for personal use only, recording copyrighted material is illegal without the permission of the copyright holder.
2. **AC Fuse**—The AC fuse inside the unit is not user-serviceable. If you cannot turn on the unit, contact your Onkyo dealer.
3. **Care**—Occasionally you should dust the unit all over with a soft cloth. For stubborn stains, use a soft cloth dampened with a weak solution of mild detergent and water. Dry the unit immediately afterwards with a clean cloth. Don't use abrasive cloths, thinners, alcohol, or other chemical solvents, because they may damage the finish or remove the panel lettering.
4. **Power**  
**WARNING**  
BEFORE PLUGGING IN THE UNIT FOR THE FIRST TIME, READ THE FOLLOWING SECTION CAREFULLY.  
AC outlet voltages vary from country to country. Make sure that the voltage in your area meets the voltage requirements printed on the unit's rear panel (e.g., AC 230, 50 Hz or AC 120 V, 60 Hz).  
  
The power cord plug is used to disconnect this unit from the AC power source. Make sure that the plug is readily operable (easily accessible) at all times.  
  
Some models have a voltage selector for compatibility with power systems around the world. Before you plug in such a model, make sure that the voltage selector is set to the correct voltage for your area.  
Pressing the [ON/STANDBY] button to select Standby mode does not fully shutdown the unit. If you do not intend to use the unit for an extended period, remove the power cord from the AC outlet.
5. **Never Touch this Unit with Wet Hands**—Never handle this unit or its power cord while your hands are wet or damp. If water or any other liquid gets inside this unit, have it checked by your Onkyo dealer.
6. **Handling Notes**
  - If you need to transport this unit, use the original packaging to pack it how it was when you originally bought it.
  - Do not leave rubber or plastic items on this unit for a long time, because they may leave marks on the case.
  - This unit's top and rear panels may get warm after prolonged use. This is normal.
  - If you do not use this unit for a long time, it may not work properly the next time you turn it on, so be sure to use it occasionally.

## For U.S. models

### FCC Information for User

#### CAUTION:

The user changes or modifications not expressly approved by the party responsible for compliance could void the user's authority to operate the equipment.

#### NOTE:

This equipment has been tested and found to comply with the limits for a Class B digital device, pursuant to Part 15 of the FCC Rules. These limits are designed to provide reasonable protection against harmful interference in a residential installation.

This equipment generates, uses and can radiate radio frequency energy and, if not installed and used in accordance with the instructions, may cause harmful interference to radio communications. However, there is no guarantee that interference will not occur in a particular installation. If this equipment does cause harmful interference to radio or television reception, which can be determined by turning the equipment off and on, the user is encouraged to try to correct the interference by one or more of the following measures:

- Reorient or relocate the receiving antenna.
- Increase the separation between the equipment and receiver.
- Connect the equipment into an outlet on a circuit different from that to which the receiver is connected.
- Consult the dealer or an experienced radio/TV technician for help.

## For Canadian Models

**NOTE:** THIS CLASS B DIGITAL APPARATUS COMPLIES WITH CANADIAN ICES-003.

For models having a power cord with a polarized plug:

**CAUTION:** TO PREVENT ELECTRIC SHOCK, MATCH WIDE BLADE OF PLUG TO WIDE SLOT, FULLY INSERT.

## Modèle pour les Canadiens

**REMARQUE:** CET APPAREIL NUMÉRIQUE DE LA CLASSE B EST CONFORME À LA NORME NMB-003 DU CANADA.

Sur les modèles dont la fiche est polarisée:

**ATTENTION:** POUR ÉVITER LES CHOCES ÉLECTRIQUES, INTRODUIRE LA LAME LA PLUS LARGE DE LA FICHE DANS LA BORNE CORRESPONDANTE DE LA PRISE ET POUSSER JUSQU'AU FOND.

**For British models**

Replacement and mounting of an AC plug on the power supply cord of this unit should be performed only by qualified service personnel.

**IMPORTANT**

The wires in the mains lead are coloured in accordance with the following code:

- Blue: Neutral
- Brown: Live

As the colours of the wires in the mains lead of this apparatus may not correspond with the coloured markings identifying the terminals in your plug, proceed as follows:

The wire which is coloured blue must be connected to the terminal which is marked with the letter N or coloured black.

The wire which is coloured brown must be connected to the terminal which is marked with the letter L or coloured red.

**IMPORTANT**

The plug is fitted with an appropriate fuse. If the fuse needs to be replaced, the replacement fuse must approved by ASTA or BSI to BS1362 and have the same ampere rating as that indicated on the plug. Check for the ASTA mark or the BSI mark on the body of the fuse.

If the power cord's plug is not suitable for your socket outlets, cut it off and fit a suitable plug. Fit a suitable fuse in the plug.

**For European Models**

Declaration of Conformity

We, ONKYO EUROPE  
ELECTRONICS GmbH  
LIEGNITZERSTRASSE 6,  
82194 GROEBENZELL,  
GERMANY



declare in own responsibility, that the ONKYO product described in this instruction manual is in compliance with the corresponding technical standards such as EN60065, EN55013, EN55020 and EN61000-3-2, -3-3.

GROEBENZELL, GERMANY

K. MIYAGI

ONKYO EUROPE ELECTRONICS GmbH

**Table of Contents**

**Introduction**

**Important Safety Instructions** ..... 2  
**Precautions**..... 3  
**Table of Contents** ..... 4  
**Supplied Accessories**..... 5  
 Installing the Batteries ..... 5  
**Features** ..... 5  
**Getting to Know the Receiver** ..... 6  
 Front Panel ..... 6  
 Rear Panel..... 8  
 Display ..... 9  
**Remote Controller** ..... 10  
 Using the Remote Controller ..... 11

**Connections**

**Connecting Your Speakers** ..... 12  
 Speaker Connection Precautions ..... 12  
 Connecting the Speaker Cables ..... 12  
**Connecting Antenna** ..... 13  
 Connecting the Indoor FM Antenna ..... 13  
 Connecting the AM Loop Antenna ..... 13  
 Connecting an Outdoor FM Antenna ..... 14  
 Connecting an Outdoor AM Antenna ..... 14  
**Connecting Your Components** ..... 15  
 Connecting a Turntable ..... 15  
 Connecting a CD Player ..... 15  
 Connecting a Recording Component ..... 16  
 Connecting a Remote Interactive Dock (RI Dock)..... 16  
 Connecting a DVD Player..... 16  
 Connecting a TV or Other Component with an Audio Output ..... 17  
 Connecting **RI** Components..... 17  
 Connecting the Power Cords of Other Components ..... 18  
 Connecting the Power Cord ..... 18

**Enjoying Audio Sources**

**Turning On the Receiver** ..... 19  
 Turning On and Standby ..... 19  
 Changing the Input Display ..... 19  
**Enjoying Audio Sources**..... 20  
 Muting the receiver (remote controller only) ..... 21  
 Using Headphones ..... 21  
 Setting the Display Brightness..... 21  
 Using the Sleep Timer (remote controller only) ..... 21  
 Using the Tone and Balance Controls ..... 22  
**Recording** ..... 23  
 Recording the Input Source ..... 23  
**Listening to the Radio** ..... 25  
 AM Frequency Step Setup (not North America and Europe) ..... 25  
 Listening to AM/FM Stations ..... 25  
 Using RDS (European Models Only) ..... 27  
**Naming Preset Channels (other than European model)** ..... 29  
 Entering a Name ..... 29  
 Correcting a Character ..... 29  
**Connecting Components not Reached by the Remote Controller Signals (IR IN/OUT)** ..... 30  
 If Remote Controller Signal Does not Reach the Receiver Remote Sensor ..... 30  
 If Remote Controller Signal Does not Reach Other Components ..... 30

**Others**

**Troubleshooting** ..... 31  
**Specifications** ..... 33

# Supplied Accessories

Make sure you have the following accessories:

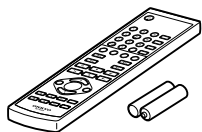

Remote controller and two batteries (AA/R6)



Indoor FM antenna

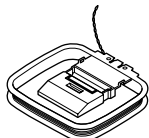

AM loop antenna

\* In catalogs and on packaging, the letter at the end of the product name indicates the color. Specifications and operation are the same regardless of color.

## Installing the Batteries

- 1 Detach the battery cover by pressing the tab and pulling up the cover.**

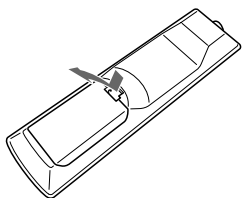

- 2 Insert two AA-size batteries into the battery compartment.**

Carefully follow the polarity diagram (positive + and negative - symbols) inside the battery compartment.

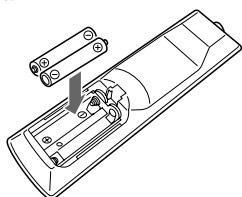

- 3 After batteries are installed and seated correctly, attach the compartment cover.**

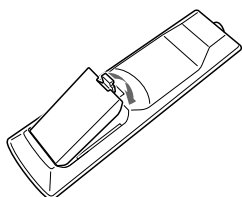

### Notes:

- If the remote controller doesn't work reliably, try replacing the batteries.
- Don't mix new and old batteries or different types of batteries.
- If you intend not to use the remote controller for a long time, remove the batteries to prevent damage from leakage or corrosion.
- Expired batteries should be removed as soon as possible to prevent damage from leakage or corrosion.

## Features

- Newly Designed, Brushed Hairline Aluminum Front Panel
- 50 Watts/Channel @ 8 ohms (FTC) (North American model)
- 90 Watts/Channel @ 4 ohms (IEC) (European and Australian model)
- WRAT (Wide Range Amplifier Technology)
- High-Current, Low-Impedance Drive
- Discrete Output Stage Circuitry
- 5 Audio Inputs (CD, TAPE 1, TAPE 2, LINE 1/ DVD, LINE 2) and 2 Outputs
- Phono Input
- Speaker A/B Terminals
- RDS (PS/PTY/RT/TP) (European model)
- IR Input/Output
- Banana Plug-Compatible Speaker Posts (North American model)
- Compatible with RI Dock for the iPod

# Getting to Know the Receiver

## Front Panel

### North American Model

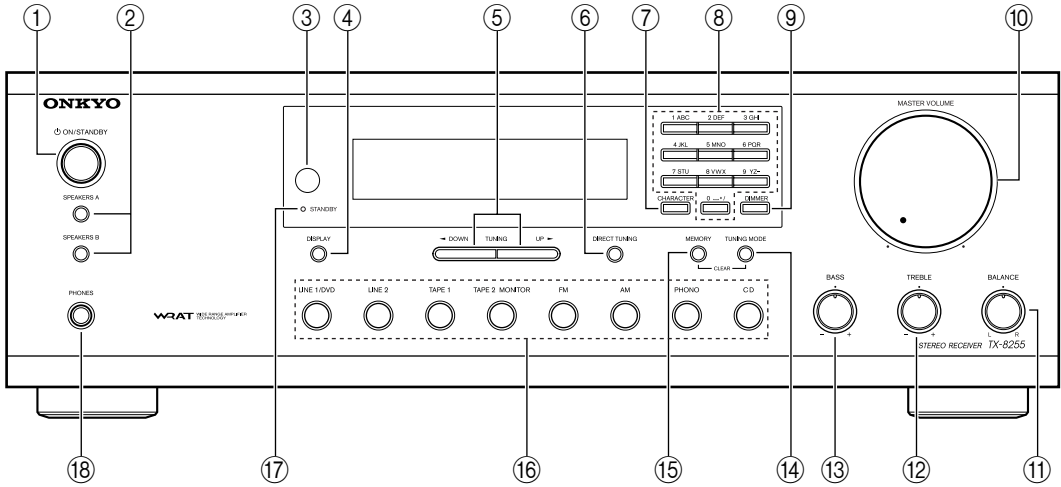

### Other Models

\* The name of the buttons and other controls varies according to the shipping destination. For details, refer to the description on the next page.

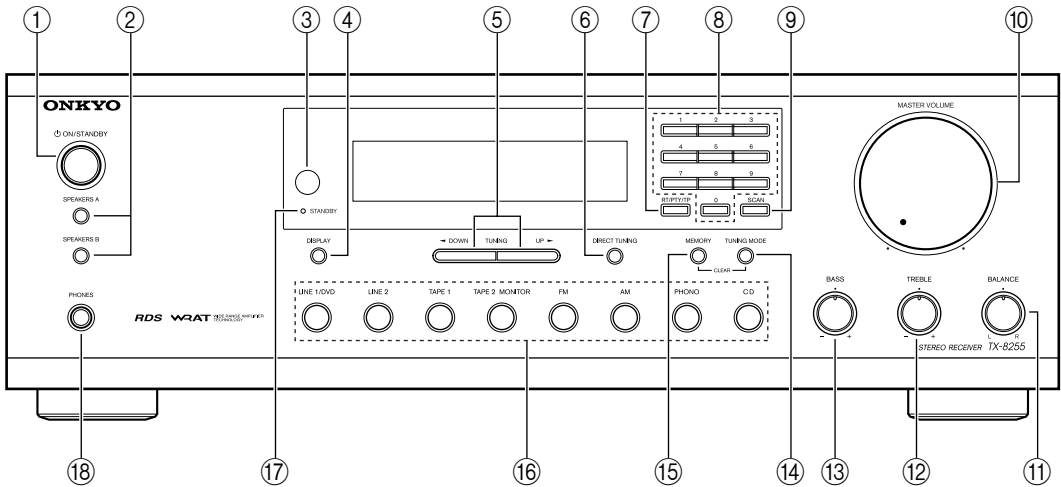

## Getting to Know the Receiver—Continued

---

Some button number sections (such as ⑦ and ⑨) contain multiple button descriptions because the name and function vary according to the model or shipping destination. Refer to the description corresponding to your model.

For detailed information, see the pages in parentheses.

- ① **ON/STANDBY button (19)**  
Sets the receiver to On or Standby.
- ② **SPEAKERS A and B switches (20)**  
Turn speaker sets A and B on or off.
- ③ **Remote-control sensor (11)**  
Receives control signals from the remote controller.
- ④ **DISPLAY (27)**  
Displays various information about the currently selected input source.
- ⑤ **TUNING UP/DOWN buttons (25, 28)**  
Used for radio tuning.
- ⑥ **DIRECT TUNING button (26)**  
When you know the frequency for the station you want to listen to, you can select the station by entering the frequency directly using this button and number buttons. When SAT RADIO is selected, you can select the channel number.
- ⑦ **CHARACTER button**  
Used to label the FM or AM station preset number.  
**RT/PTY/TP button (28)**  
On the European model, this is the RT/PTY/TP button, and it's used with RDS (Radio Data System). See "Using RDS (European Models Only)" on page 27.
- ⑧ **Number buttons (26, 29)**  
Used to select a station by entering the frequency directly or to enter characters to label the station preset number.
- ⑨ **DIMMER button (21)**  
Adjusts the display brightness.  
**SCAN button (28)**  
Used to find a station in RDS broadcasting.
- ⑩ **MASTER VOLUME control (20)**  
Sets the volume of the receiver.
- ⑪ **BALANCE control (22)**  
This control is for adjusting the sound level balance between the left and right channel for speakers and headphones.
- ⑫ **TREBLE control (22)**  
This control is for adjusting the level of treble sounds.
- ⑬ **BASS control (22)**  
This control is for adjusting the level of bass sounds.
- ⑭ **TUNING MODE button (25, 26)**  
Selects the Auto or Manual tuning mode for AM and FM radio.
- ⑮ **MEMORY button (26)**  
Used when storing or deleting radio presets.
- ⑯ **Input selector buttons (20, 23)**  
Used to select the input sources.  
The TAPE 2 MONITOR button is also used to monitor the recorded sound.
- ⑰ **STANDBY indicator (19)**  
Lights up when the receiver is on Standby and flashes while a signal is being received from the remote controller.
- ⑱ **PHONES jack (21)**  
This 1/4-inch phone jack is for connecting a standard pair of stereo headphones for private listening.

## Rear Panel

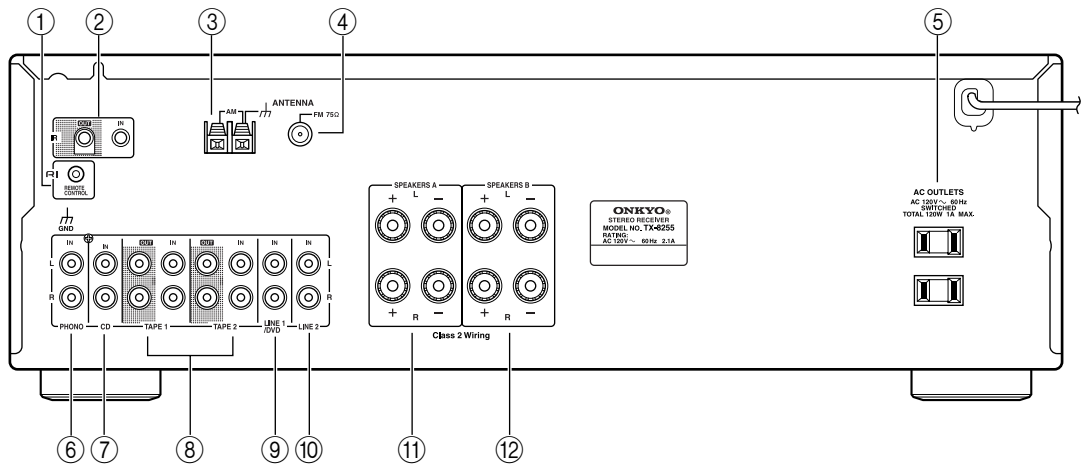

### ① RI REMOTE CONTROL jacks

These **RI** (Remote Interactive) jacks can be connected to the **RI** jacks on your other Onkyo audio components. The receiver's remote controller can then be used to control all of your components. To use **RI**, you must make an analog audio connection between the receiver and each component.

### ② IR IN/OUT

A commercially available IR receiver can be connected to the IR IN jack, allowing you to control the receiver when it's out of sight, for example, installed in a cabinet.

A commercially available IR emitter can be connected to the IR OUT jack to pass IR (infrared) remote control signals along to other components.

### ③ AM ANTENNA

These push terminals are for connecting an AM antenna.

### ④ FM ANTENNA

This jack is for connecting an FM antenna.

### ⑤ AC OUTLET

This switched AC outlet can be used to supply power to another component. The type of outlet depends on the country in which you purchased your receiver.

### ⑥ PHONO (MM) input and grounding terminal

This analog audio input is for connecting a turntable with a moving-magnet cartridge. The screw located on the upper-right of the PHONO (MM) inputs is for connecting a turntable's ground wire.

### ⑦ CD input

This analog audio input is for connecting a CD player's analog audio output.

### ⑧ TAPE 1/2 IN/OUT

This analog audio input and output are for connecting a recorder with an analog audio input and output, such as a cassette deck, MD recorder, etc.

### ⑨ LINE 1/DVD

This analog audio input is for connecting a component's analog audio output (DVD, RI Dock, etc.).

### ⑩ LINE 2 input

This analog audio input is for connecting a component's analog audio output (TV, etc.).

### ⑪ SPEAKERS A

These terminal posts are for connecting speaker set A.

### ⑫ SPEAKERS B

These terminal posts are for connecting speaker set B.

See pages 12–18 for hookup information.



### Display

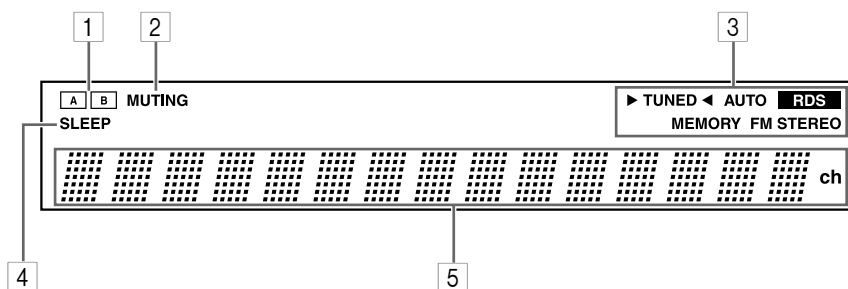

For detailed information, see the pages in parentheses.

**1 A and B speaker indicators**

Indicator A lights up when speaker set A is on.  
Indicator B lights up when speaker set B is on.

**2 MUTING indicator**

Flashes while the receiver is muted.

**3 Radio indicators**

**TUNED:** Lights up when tuned to a radio station.

**AUTO:** For AM and FM radio, lights up when Auto Tuning is selected, and disappears when Manual Tuning mode is selected.

**RDS (European models only):** Lights up when tuned to a radio station that supports RDS (Radio Data System).

**MEMORY:** Lights up when presetting radio stations.

**FM STEREO:** Lights up when tuned to a stereo FM station.

**4 SLEEP indicator**

Lights up when the Sleep function has been set.

**5 Message area**

Displays various information about the selected input source.

# Remote Controller

For detailed information, see the pages in parentheses.

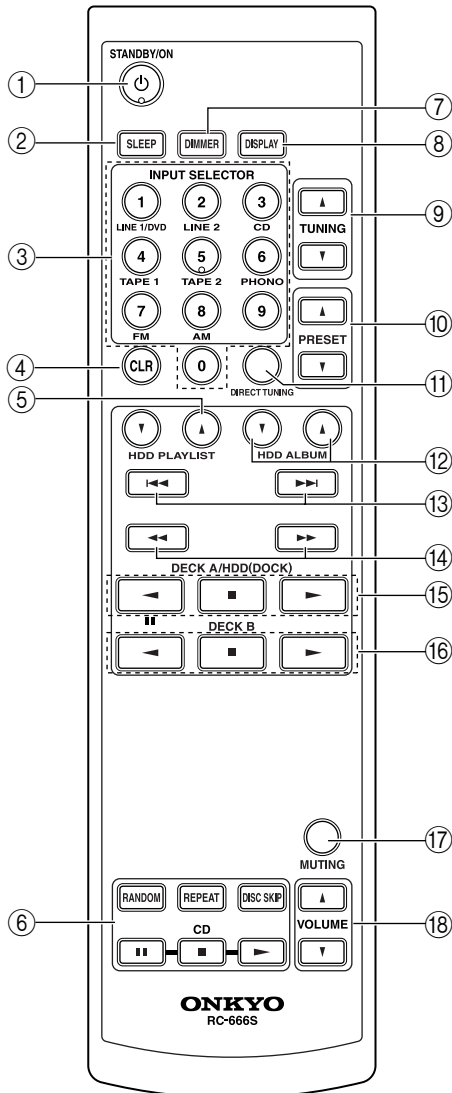

- ① **STANDBY/ON button (19)**  
Sets the receiver to On or Standby.
- ② **SLEEP button (21)**  
Used with the Sleep function.
- ③ **INPUT SELECTOR buttons (20) and number buttons (26)**  
When any of these buttons is pressed, the input source will be changed to the one shown below the button. The button with no label does not work for input source selection. After the DIRECT TUNING button is pressed, these buttons work as number button for about 5 seconds. During this time, the buttons can be used to select AM and FM radio stations and satellite radio channels directly.
- ④ **CLR button (25)**  
Used to enter the station frequency directly or cancel the number entry.
- ⑤ **HDD PLAYLIST [▲]/[▼] buttons**  
Selects a playlist stored on the player on an HDD component.
- ⑥ **CD operation buttons**  
RANDOM: Used with the random playback function.  
REPEAT: Used with the repeat playback functions.  
DISC SKIP: Switches the disc loaded when the CD changer is connected.  
[||]: Suspends playback on a CD.  
[■]: Stops playback on a CD.  
[▶]: Starts playback on a CD.
- ⑦ **DIMMER button (21)**  
Adjusts the display brightness.
- ⑧ **DISPLAY button (27)**  
Displays various information about the selected input source.
- ⑨ **TUNING [▲]/[▼] buttons (25)**  
When AM or FM is selected, the TUNING UP [▲]/DOWN [▼] buttons are used for radio tuning.
- ⑩ **PRESET [▲]/[▼] buttons (26)**  
Used to select radio presets.
- ⑪ **DIRECT TUNING button (26)**  
When you know the frequency for the station you want to listen to, you can select the station by entering the frequency directly using this button and number buttons. When SAT RADIO is selected, you can select the channel number.
- ⑫ **HDD ALBUM [▲]/[▼] buttons**  
Selects an album stored on the player on an HDD component.

### ⑬ Previous and Next [◀◀]/[▶▶] buttons

These buttons are used to select the previous or next track on an HDD component. Pressing them repeatedly selects earlier or later tracks. On a cassette deck, they're used for rewind and fast forward.

### ⑭ Reverse and Fast Forward [◀◀]/[▶▶] buttons

These buttons are used for reverse and fast forward on an HDD component.

### ⑮ DECK A/HDD (DOCK) buttons

Pause [⏸]/Reverse Play [◀◀]: Suspends playback on an HDD component; starts reverse playback on a cassette deck.

Play [▶]: Starts playback on an HDD or cassette component.

Stop [■]: Stops playback on an HDD or cassette component.

### ⑯ DECK B buttons

On twin cassette decks, only deck B can be controlled.

Play [▶]: Starts playback.

Stop [■]: Stops playback.

Reverse Play [◀◀]: Starts reverse playback.

### ⑰ MUTING button (21)

Mutes or unmutes the receiver.

### ⑱ VOLUME [▲]/[▼] buttons (20)

Adjusts the volume of the receiver regardless of the currently selected remote controller mode.

## Using the Remote Controller

Point the remote controller toward the remote control sensor.

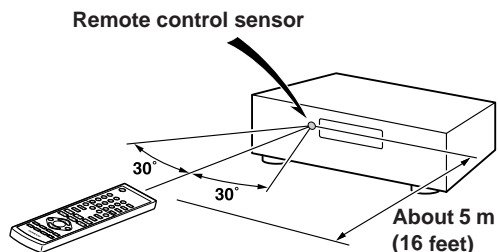

### Notes:

- The remote controller may not work reliably if the receiver is subjected to bright light, such as direct sunlight or inverter-type fluorescent lights. Keep this in mind when installing.
- If another remote controller of the same type is used in the same room, or the receiver is installed close to equipment that uses infrared rays, the remote controller may not work reliably.
- Don't put anything, such as a book, on the remote controller, because the buttons may be pressed inadvertently, thereby draining the batteries.
- The remote controller may not work reliably if the receiver is installed in a rack behind colored glass doors. Keep this in mind when installing.

The remote controller will not work if there's an obstacle between it and the receiver's remote control sensor.

# Connecting Your Speakers

Disconnect the power cord from the wall outlet before making any connections.

## Speaker Connection Precautions

The receiver allows you to connect two sets of speakers. When two sets of speakers are connected, you can select which speaker set outputs sound or use both sets to output sound simultaneously.

- When you connect one set of speakers to either SPEAKERS A or SPEAKERS B terminal posts, or when you connect two sets of speakers to both speaker terminal posts and output sound only from either speaker set, use speakers whose impedance is between 4 and 16 ohms.
- When you connect speakers to both SPEAKER A and SPEAKER B terminal posts and output sound from both speaker sets simultaneously, use speakers whose impedance is between 8 and 16 ohms.

### Note:

If you make an incorrect setting for the speakers or the impedance values, the built-in protection circuit may be activated resulting in no sound output from speakers.

The following illustration shows which speaker should be connected to each pair of terminals.

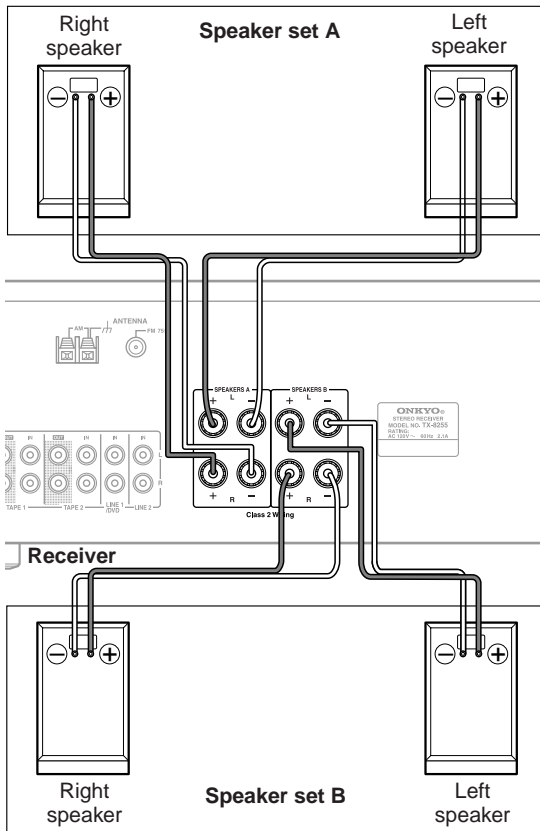

## Connecting the Speaker Cables

- 1 Strip about 15 mm (5/8 inch) of insulation from the ends of the speaker cables, and twist the bare wires tightly, as shown.

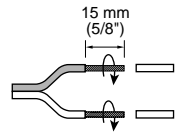

- 2 Unscrew the terminal.



- 3 Fully insert the bare wires.



- 4 Screw the terminal tight.



- Read the instructions supplied with your speakers.
- Pay close attention to speaker wiring polarity. In other words, connect positive (+) terminals only to positive (+) terminals, and negative (-) terminals only to negative (-) terminals. If you get them the wrong way around, the sound will be out of phase and will sound unnatural.
- Unnecessarily long or very thin speaker cables may affect the sound quality and should be avoided.
- Be careful not to short the positive and negative wires. Doing so may damage the receiver.
- Don't connect more than one cable to each speaker terminal. Doing so may damage the receiver.
- Don't connect a speaker to more than one pair of speaker terminals.

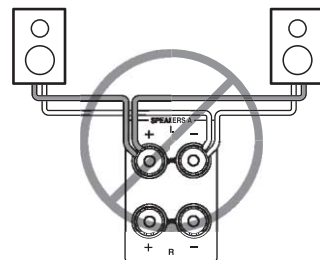
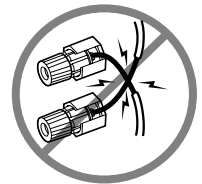

# Connecting Antenna

This section explains how to connect the supplied indoor FM antenna and AM loop antenna, and how to connect commercially available outdoor FM and AM antennas. The receiver won't pick up any radio signals without any antenna connected, so you must connect the antenna to use the tuner.

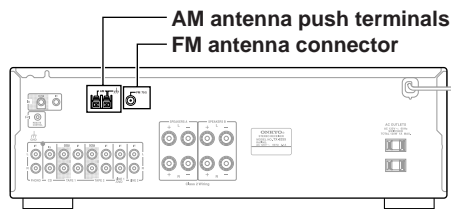

## Connecting the Indoor FM Antenna

The supplied indoor FM antenna is for indoor use only.

### 1 Attach the FM antenna, as shown.

#### ■ North American Model

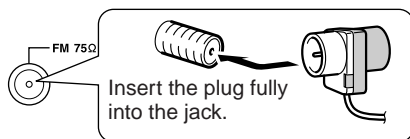

#### ■ Other Models

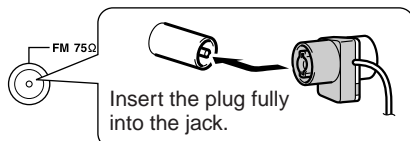

Once your receiver is ready for use, you'll need to tune into an FM radio station and adjust the position of the FM antenna to achieve the best possible reception.

### 2 Use thumbtacks or something similar to fix the FM antenna into position.

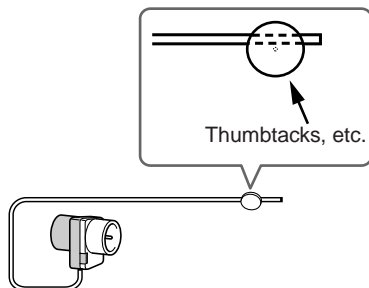

**Caution:** Be careful that you don't injure yourself when using thumbtacks.

If you cannot achieve good reception with the supplied indoor FM antenna, try a commercially available outdoor FM antenna instead (see page 14).

## Connecting the AM Loop Antenna

The supplied indoor AM loop antenna is for indoor use only.

### 1 Assemble the AM loop antenna, inserting the tabs into the base, as shown.

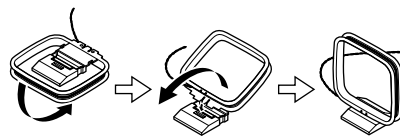

### 2 Connect both wires of the AM loop antenna to the AM push terminals, as shown.

(The antenna's wires are not polarity sensitive, so they can be connected either way around.)

Make sure that the wires are attached securely and that the push terminals are gripping the bare wires, not the insulation.

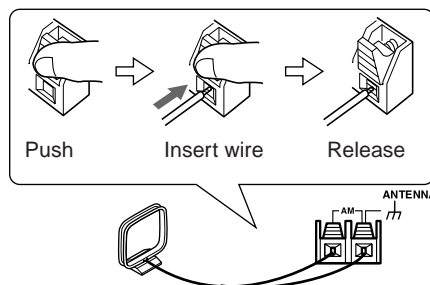

Once your receiver is ready for use, you'll need to tune into an AM radio station and adjust the position of the AM antenna to achieve the best possible reception.

Keep the antenna as far away as possible from your receiver, TV, speaker cables, and power cords.

If you cannot achieve good reception with the supplied indoor AM loop antenna, try using it with a commercially available outdoor AM antenna (see page 14).

### Connecting an Outdoor FM Antenna

If you cannot achieve good reception with the supplied indoor FM antenna, try a commercially available outdoor FM antenna instead.

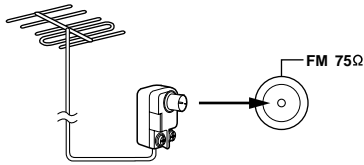

#### Notes:

- Outdoor FM antennas work best outside, but usable results can sometimes be obtained when installed in an attic or loft.
- For best results, install the outdoor FM antenna well away from tall buildings, preferably with a clear line of sight to your local FM transmitter.
- Outdoor antenna should be located away from possible noise sources, such as neon signs, busy roads, etc.
- For safety reasons, outdoor antenna should be situated well away from power lines and other high-voltage equipment.
- Outdoor antenna must be grounded in accordance with local regulations to prevent electrical shock hazards.

#### ■ Using a TV/FM Antenna Splitter

It's best not to use the same antenna for both FM and TV reception, as this can cause interference problems. If circumstances demand it, use a TV/FM antenna splitter, as shown.

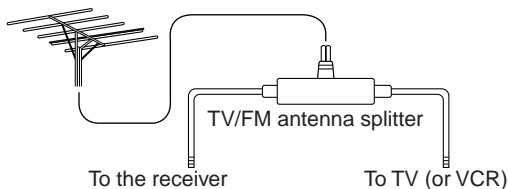

### Connecting an Outdoor AM Antenna

If good reception cannot be achieved using the supplied AM loop antenna, an outdoor AM antenna can be used in addition to the loop antenna, as shown.

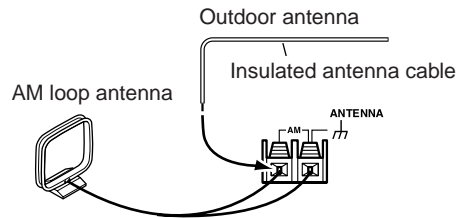

Outdoor AM antennas work best when installed outside horizontally, but good results can sometimes be obtained indoors by mounting horizontally above a window. Note that the AM loop antenna should be left connected. Outdoor antenna must be grounded in accordance with local regulations to prevent electrical shock hazards.

# Connecting Your Components

## Before Making any Connections

- Always refer to the instructions that came with the component that you are connecting.
- Do not plug in the power cord until all connections have been properly made.
- Do not bind audio cables with power cords and speaker cables. Doing so may adversely affect the sound quality.
- To prevent interference, keep power cords and speaker cables away from the tuner's antenna.

## Connection Color Coding

Use red plugs to connect right-channel audio inputs and outputs (typically labeled "R"). Use white plugs to connect left-channel audio inputs and outputs (typically labeled "L").



- Push each plug in all the way to make a good connection (loose connections can cause noise or malfunctions).

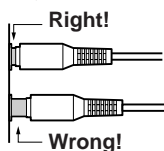

## Connecting a Turntable

The receiver's PHONO input jacks are for use with moving-magnet (MM) type cartridges. Use an analog audio cable to connect the receiver's PHONO L/R jacks to the audio output jacks on the turntable, as shown.

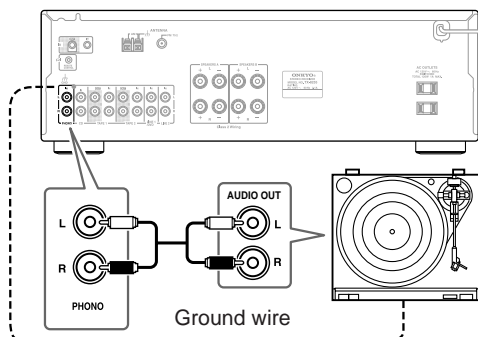

### Notes:

- If the turntable has a ground wire, connect it to receiver's GND terminal. With some turntables, connecting the ground wire may cause hum, in which case it should be disconnected.
- If the turntable has a moving-coil (MC) type cartridge, you'll need a commercially available MC phono preamp. In this case, connect the turntable to the phono preamp's input, and connect the phono preamp's output to the receiver's PHONO L/R jacks.

## Connecting a CD Player

Use an analog audio cable to connect the receiver's CD L/R jacks to the analog audio output jacks on the CD player, as shown.

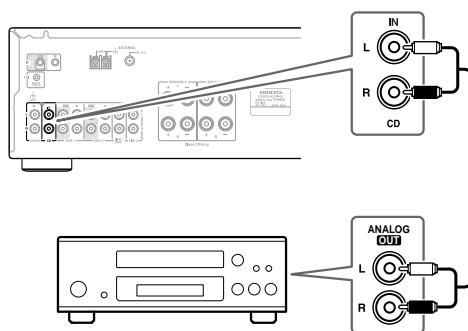

### Connecting a Recording Component

To connect recording components, such as cassette deck, MD recorder and CD recorder, use an analog audio cable to connect the receiver's TAPE 1 or 2 IN L/R jacks to the cassette deck's analog audio output jacks, and use another analog audio cable to connect the receiver's TAPE 1 or 2 OUT L/R jacks to the cassette deck's analog audio input jacks, as shown.

When you want to monitor the recorded sound, use the TAPE 2 jacks for connecting a recorder.

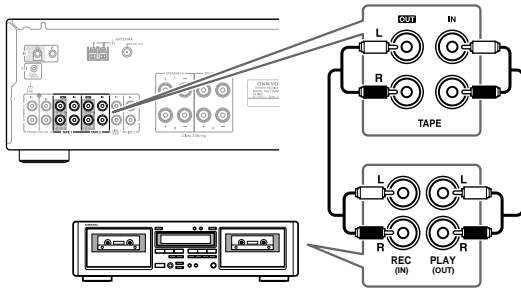

### Connecting a Remote Interactive Dock (RI Dock)

Use an analog audio cable to connect the TAPE 1 IN L/R jacks to the RI Dock's analog audio output jacks. Then use an **RI** cable to connect the receiver's **RI** jack to the RI Dock's **RI** jack, as shown.

When you change the input display name to "HDD," you can operate the RI Dock using the remote controller supplied with the receiver (see page 19).

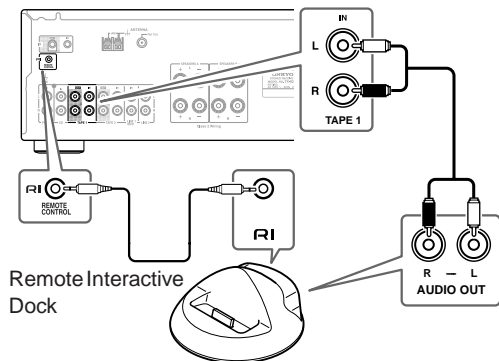

#### Note:

If you use the Onkyo Remote Interactive Dock (DS-A1), flip the RI MODE switch to "HDD" which is located on the underside.

### Connecting a DVD Player

Only audio input from the DVD player can be received. The video input from the DVD player should be connected to the TV directly.

Use an analog audio cable to connect the LINE 1/DVD IN L/R jacks to the analog audio output jacks on the DVD player.

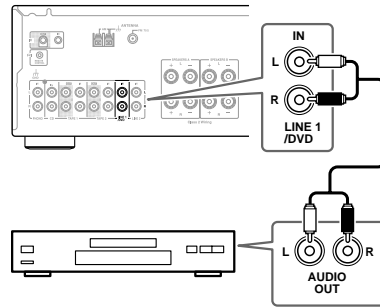



### Connecting a TV or Other Component with an Audio Output

Use an analog audio cable to connect the LINE 1/DVD IN L/R or LINE 2 IN L/R jacks to the analog audio output jacks on the connected component.

When you connect a VCR, the video input from the VCR should be sent to the TV directly.

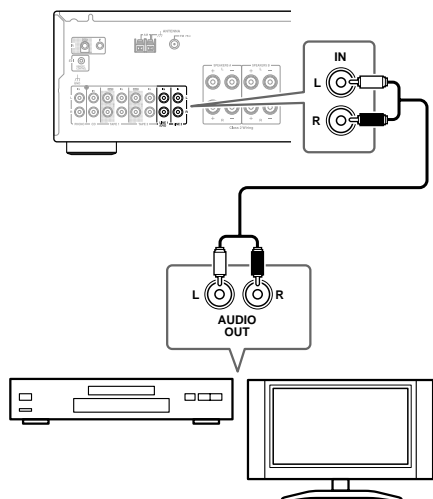

### Connecting RI Components

If you connect other Onkyo components to the receiver with the appropriate **RI** and audio cables, you can use the following system functions. **RI** cables are special cables solely for use with Onkyo products (no **RI** cables are supplied with the receiver).

#### Auto Power On

When you turn on the power or start playback on a component that's connected to the receiver, the receiver will turn on automatically. And when you set the receiver to Standby, all connected components will go on Standby as well (the receiver's **POWER** switch must be set to **ON** for this to work).

#### Direct Change

When playback is started on an audio component connected via **RI**, the receiver will automatically select that component as the input source.

#### Remote Control Operation

You can control all components in your system by using the receiver's remote controller. See pages 10-11 for more information.

With **RI** (Remote Interactive), you can control your **RI**-compatible Onkyo CD player, **RI** Dock, and so on with the receiver's remote controller.

- To use **RI**, you must make an analog audio connection between the receiver and each audio component.

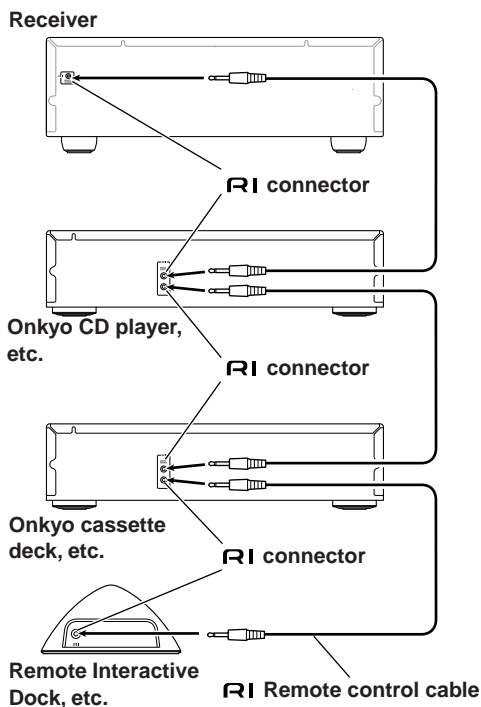

#### Notes:

- Push each plug in all the way to make a good connection.
- Use only dedicated **RI** cables for **RI** connections (no **RI** cables are supplied with the receiver).
- **RI** jacks should be connected only to Onkyo components. Connecting them to another manufacturer's component may cause the receiver to malfunction.
- Some components may not support all **RI** functions. See the manuals supplied with your other Onkyo components for more information.

### Connecting the Power Cords of Other Components

The receiver has AC outlets on its rear panel that can be used to connect the power cords of other components that you intend to use with the receiver. These components can then be left turned on so that they turn on and off as and when the receiver is turned on and set to Standby.

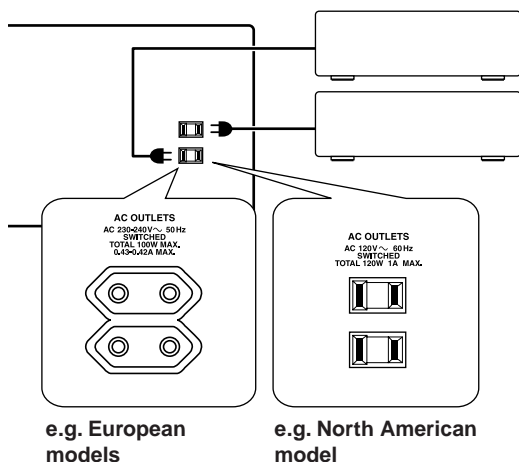

#### Caution:

- Make sure that the total capacity of the components that you connect to the AC OUTLETS does not exceed the stated capacity (e.g., TOTAL 120 W).

#### Notes:

- Onkyo components connected via **RI** should be connected directly to a wall outlet, not an AC OUTLETS on the receiver.
- The number of AC OUTLETS, socket type, and total capacity depends on the country in which you purchased the receiver.

### Connecting the Power Cord

- Connect the receiver's power cord to a suitable wall outlet.

#### Notes:

- **Before connecting the power cord, connect all of your speakers and AV components.**
- Turning on the receiver may cause a momentary power surge that might interfere with other electrical equipment on the same circuit. If this is a problem, plug the receiver into a different branch circuit.

# Turning On the Receiver

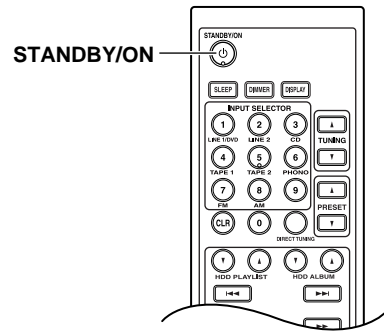
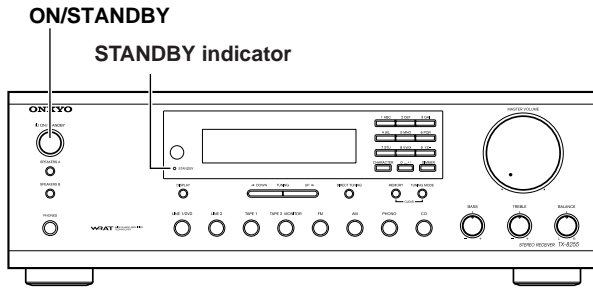

## Turning On and Standby

1

Receiver

ON/STANDBY



or

Remote controller

STANDBY/ON



Press the [ON/STANDBY] button. Alternatively, press the remote controller's [STANDBY/ON] button.

The receiver comes on, the display lights up, and the STANDBY indicator goes off.

To turn the receiver off, press the [ON/STANDBY] button, or press the remote controller's [STANDBY/ON] button. The receiver will enter Standby mode. To prevent any loud surprises when you next turn on the receiver, always turn down the volume before you turn it off.

## Changing the Input Display

You can change the input display name to "HDD". When the input display name has been changed "HDD" for TAPE 1, the display name for the other button cannot be changed to "HDD".

After you changed the input display name, you can operate the RI Dock using the remote controller supplied with the receiver (see pages 10-11).

1

TAPE 1



Press the appropriate input selector button.

The selected input name appears in the display.

2

Press and hold down the input selector button selected in the Step 1 above for approximately 3 seconds to change the display name.

# Enjoying Audio Sources

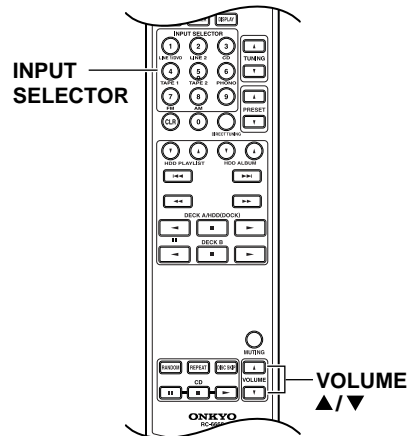
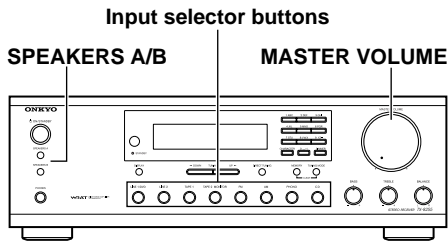

- 1**

**Receiver**

**Remote controller**

**Press the input selector button to select the component that you want to listen to.**

---

- 2**

**Receiver**

**Remote controller**

**Use the [SPEAKERS A] and [SPEAKERS B] buttons on the receiver to select the speaker set that you want to use.**

The A and B speaker indicators show whether each speaker set is on or off.

A
B
— Indicators

---

- 3**

**Start playback on the selected component.**

---

- 4**

**Receiver**

**Remote controller**

**To adjust the volume, use the receiver's [MASTER VOLUME] control, or the remote controller's VOLUME [▲]/[▼] buttons.**

Turn the control clockwise to turn up the volume or counterclockwise to turn down the volume.

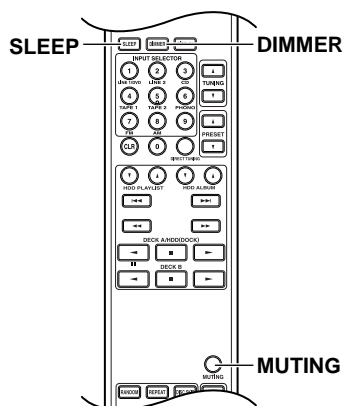
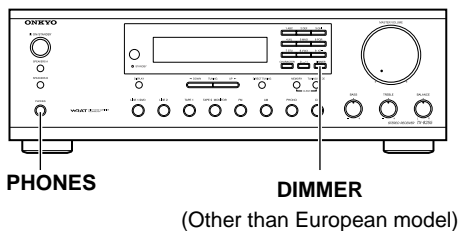

## Muting the receiver (remote controller only)

You can temporarily mute the output of the receiver.

1



Press the remote controller's [MUTING] button.

The receiver is muted.

To unmute the receiver, press the [MUTING] button again.

### Note:

The Mute function will be cancelled if the remote controller's VOLUME buttons are pressed or the receiver is set to Standby.

## Using Headphones

You can connect a pair of stereo headphones (1/4-inch phone plug) to the receiver's PHONES jack for private listening.

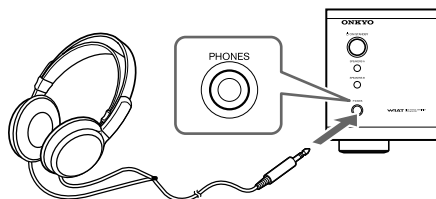

### Notes:

- Always turn down the volume before connecting your headphones.
- Sound output from speakers is not turned off even if (when) the headphones plug is inserted in the PHONES jack. To turn off or on the sound output from speakers, use the SPEAKERS A and SPEAKERS B buttons.

## Setting the Display Brightness

You can adjust the brightness of the display.

1

Remote controller



Press the remote controller's [DIMMER] button repeatedly to select: dim, dimmer, or normal brightness.

Receiver



Alternatively, you can use the [DIMMER] button on the receiver (other than European model).

## Using the Sleep Timer (remote controller only)

With the sleep timer, you can set the receiver so that it turns off automatically after a specified period.

1

Remote controller



Press the remote controller's [SLEEP] button repeatedly to select the required sleep time.

You can set the sleep time from 90 to 10 minutes in 10 minute steps.

The SLEEP indicator appears on the display when the sleep timer has been set, as shown. The specified sleep time appears on the display for about 5 seconds, then the previous display reappears.

SLEEP indicator

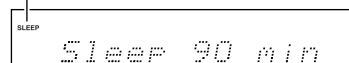

To cancel the sleep timer, press the [SLEEP] button repeatedly until the SLEEP indicator disappears.

To check the remaining sleep time, press the [SLEEP] button. Note that if you press the [SLEEP] button while the sleep time is being displayed, you'll shorten the sleep time by 10 minutes.

## Enjoying Audio Sources—Continued

---

This section explains functions that can be used with any input source.

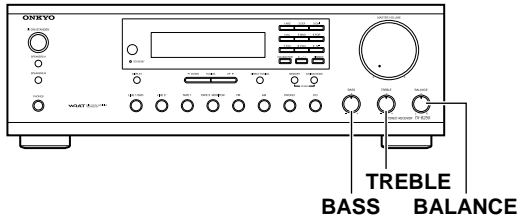

### Using the Tone and Balance Controls

#### ***Adjusting the Bass***

The BASS control adjusts bass sounds. Turn it up to make them louder. Turn it down to make them quieter. Normally, it should be set midway.

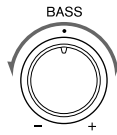

#### ***Adjusting the Treble***

The TREBLE control adjusts treble sounds. Turn it up to make them louder. Turn it down to make them quieter. Normally, it should be set midway.

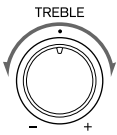

#### ***Adjusting the Balance***

The BALANCE control is used to control the relative volume level of the left and right speaker systems or headphones.

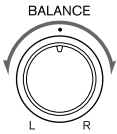

# Recording

**Unless you have the full consent of the copyright holder, copyright laws prohibit using your recordings for anything other than personal enjoyment!**

This section explains how to record the selected input source to a component with recording capability.

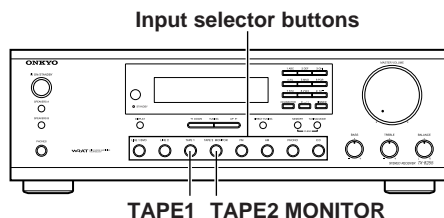

## Recording the Input Source

You can record an audio signal on a recording component connected to the TAPE 1 OUT or TAPE 2 OUT jacks.

When you record an audio signal on a recording component connected to the TAPE 2 OUT jacks, you can monitor the recorded sound. For details, refer to the section “Monitoring the Recorded Sound” below.

When you want to record the input from the TAPE 2 IN jacks, you cannot record the sound on a recording component connected to the TAPE 1 OUT jacks.

- 1 Prepare the recorder:**
  - Set the recorder so that it's ready for recording.
  - If necessary, adjust the recording level on the recorder.
  - See the recorder's manual for more information.
- 2 Use an input selector button other than “TAPE 2 MONITOR” to select the component that you want to record from.**
- 3 Start playback on the component selected in step 1.**

**Note:**  
If you select another input source during recording, the newly selected input source will be recorded.

**Note:**

The volume, balance, mute and tone controls have no effect on the signal being recorded.

## Monitoring the Recorded Sound

When you record audio signal on a recording component connected to the TAPE 2 OUT jacks, you can monitor the recorded sound. The recorded sound monitoring function allows you to compare the sounds by switching the output between the sound before or after recording.



**Pressing the TAPE 2 MONITOR button indicates a sign “T2 MONITOR OFF” on the display. Press and hold the button while the sign is displayed, and release it when the sign changes to “T2 MONITOR ON.”**

Then you will see a sign “> T-2 ON” next to the input source name in the display. However, only “>” is displayed if a tuner is selected for input source.



Use the same procedures to deactivate the sound monitoring function.

### The signal flow in monitoring the recorded sound

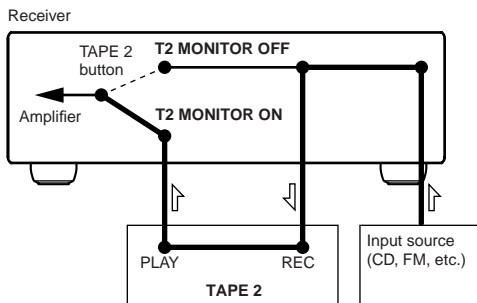

### The signal flow in monitoring the sound before recording

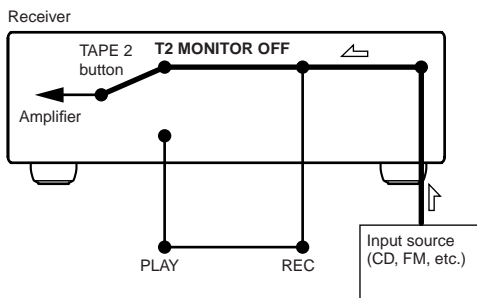



# Listening to the Radio

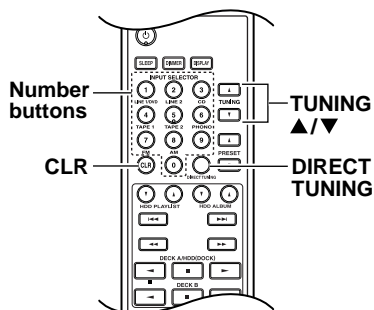
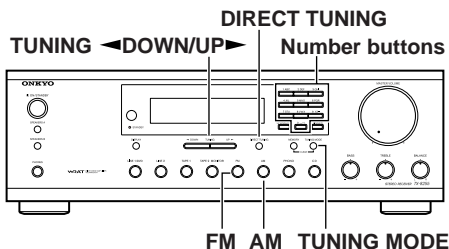

## AM Frequency Step Setup (not North America and Europe)

You must specify the AM frequency step used in your area. Note that when this setting is changed, all radio presets are deleted.

Use the receiver to perform the procedure below.

1



and

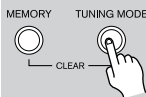

Release the button

While pressing the [AM] button, press the [TUNING MODE] button.

Each press of the [TUNING MODE] button switches the frequency step setting between “10 kHz” and “9 kHz.”

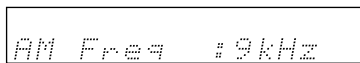
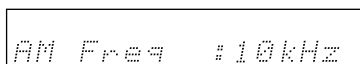

After the desired frequency step is displayed, release the [AM] button.

## Listening to AM/FM Stations

With the built-in tuner, you can enjoy AM and FM radio stations.

1

Receiver



Use the [FM] or [AM] input selector button to select AM or FM.

In this example, FM has been selected.



Band Frequency

(Actual display depends on country.)

2

Receiver

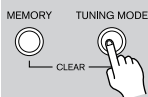

Press the [TUNING MODE] button so that the AUTO indicator appears or disappears from the display.

### Auto Tuning

To activate this mode, press the [TUNING MODE] button to turn on the “AUTO” indicator. In this mode, you will receive the broadcast in stereo sound.

### Manual Tuning

To activate this mode, press the [TUNING MODE] button to turn off the “AUTO” indicator. In this mode, you will receive the broadcast in monaural sound.

3

Receiver

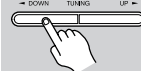

Press the TUNING [◀ DOWN] or [UP ▶] button.

You can also use the remote controller’s TUNING [▲]/[▼] buttons to tune the radio.

### Auto Tuning

Searching stops when a station is found.

### Manual Tuning





The frequency stops changing when you release the button.

Press the buttons repeatedly to change the frequency one step at a time.

## Listening to the Radio—Continued

### ■ Tuning into Stations by Frequency

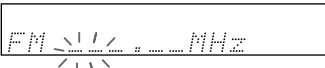

You can tune into AM and FM stations directly by entering the appropriate frequency.

<p><b>1</b></p> <p>Receiver DIRECT TUNING</p>  <p>Remote controller</p> 	<p><b>Press the [DIRECT TUNING] button.</b></p>  <p>(Actual display depends on country.)</p>
<p><b>2</b></p> <p>Receiver</p>  <p>Remote controller</p> 	<p><b>Within 8 seconds, use the number buttons to enter the frequency of the radio station.</b></p> <p>For example, to tune to 87.5 (FM), press 8, 7, 5.</p>

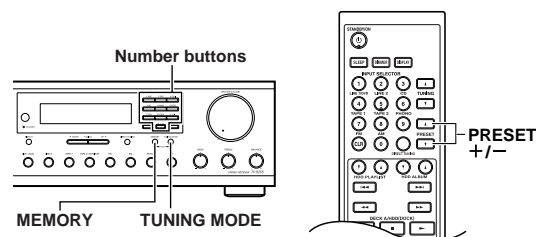
### Presetting AM/FM Stations

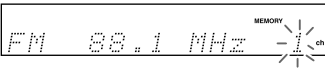

You can store a combination of up to 40 of your favorite AM/FM radio stations as presets.

<p><b>1</b></p>	<p><b>Tune into the AM/FM station that you want to store as a preset.</b></p>
<p><b>2</b></p> <p>Receiver MEMORY</p> 	<p><b>Press the [MEMORY] button.</b></p> <p>The MEMORY indicator appears and the preset number flashes.</p> 
<p><b>3</b></p> <p>Receiver</p> 	<p><b>While the MEMORY indicator is displayed (about 8 seconds), use the number buttons on the receiver to select a preset from 1 through 40.</b></p>

<p><b>4</b></p> <p>Receiver MEMORY</p> 	<p><b>Press the [MEMORY] button again to store the station or channel.</b></p> <p>The station or channel is stored and the preset number stops flashing.</p> <p>Repeat this procedure for all of your favorite AM/FM radio stations.</p>
--	--

### ■ Selecting Presets

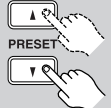
<p><b>1</b></p> <p>Receiver</p>  <p>Remote controller</p> 	<p><b>To select a preset, use the number buttons on the receiver, or the remote controller's PRESET [▲]/[▼] buttons.</b></p>
--	--

### ■ Deleting Presets

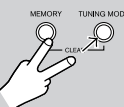
<p><b>1</b></p>	<p><b>Select the preset that you want to delete.</b></p> <p>See the previous section.</p>
<p><b>2</b></p> <p>Receiver MEMORY TUNING MODE</p> 	<p><b>While holding down the [MEMORY] button, press the [TUNING MODE] button.</b></p> <p>The preset is deleted and its number disappears from the display.</p>

The North American model changes FM frequency in 0.2 MHz steps, 10 kHz steps for AM. For other models the frequency changes in 0.05 MHz increments for FM and 9 kHz (or 10 kHz) increments for AM.

When tuned into a station, the TUNED indicator appears. When tuned into a stereo FM station, the FM STEREO indicator also appears.

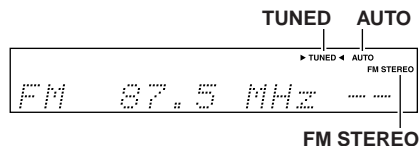

### Tuning into Weak FM Stereo Stations

If the signal from a stereo FM station is weak, it may be impossible to get good reception. In this case, switch to Manual Tuning mode and listen to the station in mono.

### Using RDS (European Models Only)

RDS only works with European models and only in areas where RDS broadcasts are available.

When tuned into an RDS station, the RDS indicator appears.

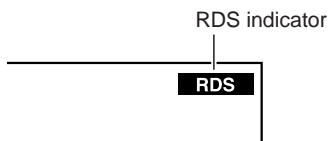

#### ■ What is RDS?

RDS stands for *Radio Data System* and is a method of transmitting data in FM radio signals. It was developed by the European Broadcasting Union (EBU) and is available in most European countries. Many FM stations use it these days. In addition to displaying text information, RDS can also help you find radio stations by type (e.g., news, sport, rock, etc.).

The receiver supports four types of RDS information:

#### **PS (Program Service)**

When tuned to an RDS station that's broadcasting PS information, the station's name will be displayed. Pressing the [DISPLAY] button will display the frequency for 3 seconds.

#### **RT (Radio Text)**

When tuned to an RDS station that's broadcasting text information, the text will be shown on the display (see page 28).

#### **PTY (Program Type)**

This allows you to search for RDS radio stations by type (see page 28).

#### **TP (Traffic Program)**

This allows you to search for RDS radio stations that broadcast traffic information (see page 28).

#### **Notes:**

- In some cases, the text characters displayed on the receiver may not be identical to those broadcast by the radio station. Also, unexpected characters may be displayed when unsupported characters are received. This is not a malfunction.
- If the signal from an RDS station is weak, RDS data may be displayed intermittently or not at all.

### RDS Program Types (PTY)

Type	Display
None	NONE
News reports	NEWS
Current affairs	AFFAIRS
Information	INFO
Sport	SPORT
Education	EDUCATE
Drama	DRAMA
Culture	CULTURE
Science and technology	SCIENCE
Varied	VARIED
Pop music	POP M
Rock music	ROCK M
Middle of the road music	EASY M
Light classics	LIGHT M
Serious classics	CLASSICS
Other music	OTHER M
Weather	WEATHER
Finance	FINANCE
Children's programmes	CHILDREN
Social affairs	SOCIAL
Religion	RELIGION
Phone in	PHONE IN
Travel	TRAVEL
Leisure	LEISURE
Jazz music	JAZZ
Country music	COUNTRY
National music	NATION M
Oldies music	OLDIES
Folk music	FOLK M
Documentary	DOCUMENT
Alarm test	TEST
Alarm	ALARM

## Displaying Radio Text (RT)

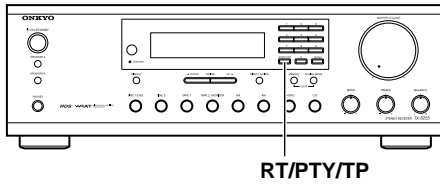

When tuned to an RDS station that's broadcasting text information, the text can be displayed.

<b>1</b> 	<p><b>Press the [RT/PTY/TP] button once.</b></p> <p>The RT information scrolls across the display.</p>
--------------	--

**Notes:**

- The message “Waiting” may appear while the receiver waits for the RT information.
- If the message “No Text Data” appears on the display, no RT information is available.

## Finding Stations by Type (PTY)

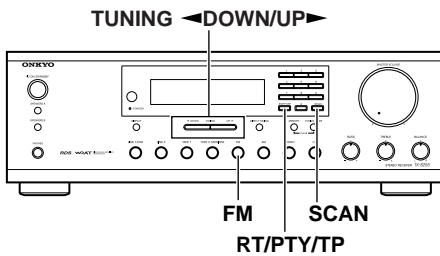

You can search for radio stations by type.

<b>1</b> 	<p><b>Use the [FM] input selector button.</b></p>
<b>2</b> 	<p><b>Press the [RT/PTY/TP] button twice.</b></p> <p>The current program type appears on the display.</p>
<b>3</b> 	<p><b>Use the TUNING [◀DOWN]/[UP▶] buttons to select the type of program you want.</b></p> <p>See the table on page 27.</p>

<b>4</b> 	<p><b>To start the search, press [SCAN].</b></p> <p>The receiver searches until it finds a station of the type you specified, at which point it stops briefly before continuing with the search.</p>
<b>5</b> 	<p><b>When a station you want to listen to is found, press [SCAN].</b></p> <p>If no stations are found, the message “Not Found” appears.</p>

## Listening to Traffic News (TP)

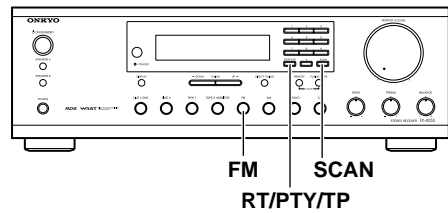

You can search for stations that broadcast traffic news.

<b>1</b> 	<p><b>Use the [FM] input selector button.</b></p>
<b>2</b> 	<p><b>Press the [RT/PTY/TP] button three times.</b></p> <p>If the current radio station is broadcasting TP (Traffic Program), “[TP]” will appear on the display, and traffic news will be heard as and when it's broadcast. If “TP” without square brackets appears, this means that the station is not broadcasting TP.</p>
<b>3</b> 	<p><b>To locate a station that is broadcasting TP, press [SCAN].</b></p> <p>The receiver searches until it finds a station that's broadcasting TP. If no stations are found, the message “Not Found” appears.</p>

# Naming Preset Channels (other than European model)

While receiving a preset FM or AM station, a maximum of 8 characters consisting of letters, numbers and some symbols can be stored, for example to represent the station name.

You cannot assign a name to the RDS station (for European model).

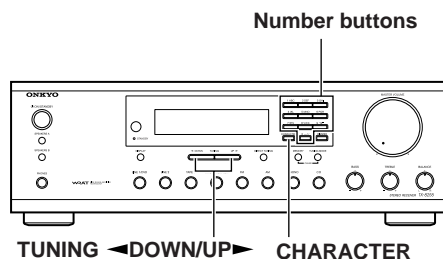

**Characters which can be entered:** A B C D E F G H I J K L M N O P Q R S T U V W X Y Z 1 2 3 4 5 6 7 8 9 0 - \_ \* /

**Note:** \_ indicates a space.



## Entering a Name

As an example, assume an FM station with a frequency of 89.50 MHz has been stored in preset number 2 and will be given the name “ONKYO.”

<b>1</b>	<p><b>Select the desired preset channel.</b> (Refer to “Selecting Presets” on page 26.)</p>
<b>2</b> Other than European model 	<p><b>Press the [CHARACTER] button on the front panel.</b> The frequency in the display goes off and the cursor ( _ ) flashes.</p>
<b>3</b> Other than European model 	<p><b>Continue pressing the [5MNO] button until “O” is displayed.</b> With each press of the button, the character that appears in the display changes one at a time in the following sequence: 5 → M → N → O → 5... If a button is not pressed within one second, the cursor automatically moves to the next position.</p>
<b>4</b>	<p><b>Continue pressing number buttons to enter the desired characters.</b> To enter N, press the [5MNO] button. To enter K, press the [4JKL] button. To enter Y, press the [9YZ-] button.</p>
<b>5</b> 	<p><b>Press the [CHARACTER] button to store the entered characters.</b> If a button is not pressed within 16 seconds, the operation will end automatically.</p>

## Note:

Press the [DISPLAY] button when you wish to check the frequency while you are entering the characters.

## Correcting a Character

<b>1</b>	<p><b>Select the desired station.</b> (Refer to “Selecting Presets” on page 26.)</p>
<b>2</b>	<p><b>Press the [CHARACTER] button.</b> The first character and the cursor flash alternately.</p>
<b>3</b>	<p><b>Press the TUNING [◀ DOWN] or [UP ▶] button to move the cursor below the character that you wish to change.</b> The cursor moves to the right when the [UP ▶] button is pressed and moves to the left when the [◀ DOWN] button is pressed. <b>Clearing all characters:</b> Press [DIRECT TUNING] button.</p>
<b>4</b>	<p><b>Enter the desired character.</b> The previous character is replaced with a new character.</p>
<b>5</b>	<p><b>Press the [CHARACTER] button.</b></p>

# Connecting Components not Reached by the Remote Controller Signals (IR IN/OUT)

In order to use the remote controller to control the receiver from a remote location, you will need to prepare a multiroom kit (sold separately) such as one listed below:

- Multiroom A/V distribution and control system such as those from Niles® and Xantech®

\* Xantech is a registered trademark of Xantech Corporation.

\* Niles is a registered trademark of Niles Audio Corporation.

## If Remote Controller Signal Does not Reach the Receiver Remote Sensor

### Effective Sensor Layout

#### Example for the main room

If the receiver is located inside a cabinet or other enclosure where the infrared rays from the remote controller cannot enter, then operation with the remote controller will not be possible. In such a case, it will be necessary to install a remote sensor at a location outside of the cabinet so that the infrared rays from the controller can be sensed.

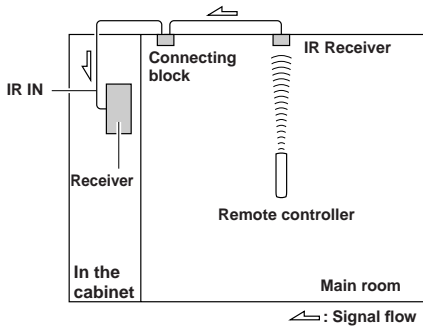

#### Example for the remote zone

The IR IN input allows you to control the receiver from the remote zone with the remote controller even though the remote zone may be on the other side of the building from the main zone. The diagram below shows how to make the proper connections for the remote zone.

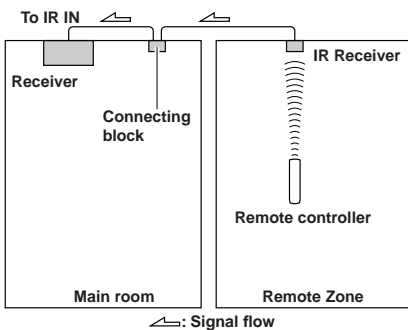

### Making Sensor Connections

When you place the IR receiver in the main room, connect the cable from the connecting block to the IR IN terminal. Make the connection as shown below. Do not plug any equipment into the power outlet until all the connections are complete.

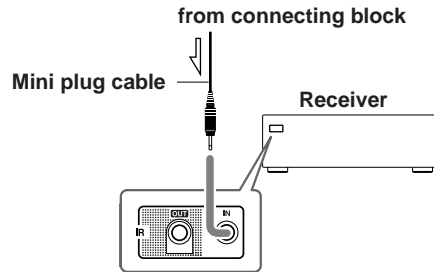

## If Remote Controller Signal Does not Reach Other Components

### Effective Sensor Layout

In this situation, you will need to use a commercially available IR emitter. Connect the mini plug of the IR emitter to the IR OUT terminal on the receiver and then place the IR emitter on the remote sensor of the component or facing it. When the IR emitter is connected, only the signal input to the IR IN terminal is output to the IR OUT terminal. The signal input from the remote sensor on the front of the receiver will not be output to the IR OUT terminal.

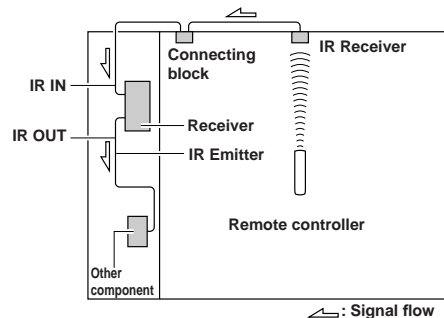

### Making Sensor Connections

When you place the IR receiver in the main room, connect the cable from the connecting block to the IR OUT terminal.

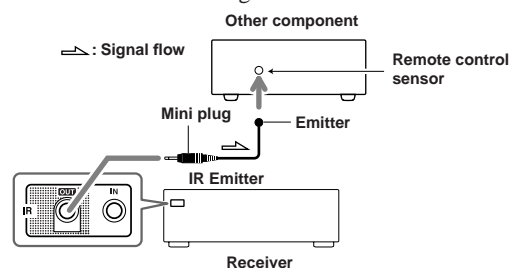

# Troubleshooting

If you have any trouble using the receiver, look for a solution in this section.

If you can't resolve the issue yourself, try resetting the receiver before contacting your Onkyo dealer.

**To reset the receiver to its factory defaults, turn it on and, while holding down the [LINE 2] button, press the [ON/STANDBY] button.**

**"Clear" will appear on the display and the receiver will enter Standby mode.**

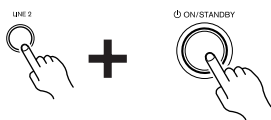

Note that resetting the receiver will delete your radio presets and custom settings.

## Power

### Can't turn on the receiver

- Make sure that the power cord is plugged into the wall outlet properly.
- Unplug the power cord from the wall outlet, wait 5 seconds or more, then plug it in again.

### The STANDBY indicator is flashing

The amp protection circuit has been activated. Remove the power cord from the wall outlet immediately. Disconnect all speaker cables and input sources, and leave the receiver with its power cord disconnected for 1 hour. After that, reconnect the power cord and press the [ON/STANDBY] button again. If you can not resolve the problem, contact your Onkyo dealer.

## Audio

### There's no sound or it's very quiet

- Make sure the speaker set A or B is on (page 20).
- Make sure that all audio connecting plugs are pushed in all the way (pages 12-18).
- Make sure that the polarity of the speaker cables is correct, and that the bare wire is in contact with metal part of each speaker terminal (page 12).
- Make sure that the speaker cables are not shorting.
- Make sure that the inputs and outputs of all components are connected properly.
- Make sure that the correct input source is selected (page 20).
- If the MUTING indicator is shown on the display, press the remote controller's [MUTING] button to unmute the receiver (page 21).
- If your turntable doesn't have a phono preamp built-in, you must connect one between it and the receiver. If your turntable uses an MC cartridge, you must connect an MC head amp, or an MC transformer and a phono preamp.

### Noise can be heard

- Using cable ties to bundle audio cables with power cords, speaker cables, and so on may degrade the audio performance, so don't do it.
- An audio cable may be picking up interference. Try repositioning your cables.

## Tuner

### Reception is noisy, stereo FM reception suffers from hiss, or the FM STEREO indicator doesn't appear

- Relocate your antenna.
- Move the receiver away from your TV or computer.
- Listen to the station in mono (page 26).
- When listening to an AM station, operating the remote controller may cause noise.
- Passing cars and airplanes can cause interference.
- Concrete walls weaken radio signals.
- If nothing improves the reception, install an outdoor antenna.

### Remote Controller

#### The remote controller doesn't work

- Make sure that the batteries are installed with the correct polarity (page 5).
- Install new batteries. Don't mix different types of batteries or old and new batteries (page 5).
- Make sure that the remote controller is not too far away from the receiver, and that there's no obstruction between the remote controller and the receiver's remote control sensor (page 11).
- Make sure that the receiver is not subjected to direct sunshine or inverter-type florescent lights. Relocate if necessary (page 11).

#### Can't control other components

- If you've connected an **RI**-capable Onkyo DS-A1 Remote Interactive Dock to the TAPE 1 jacks on the receiver, for the remote controller to work properly, you must set the input display to HDD (see page 19).
- If it's an Onkyo component, make sure that the **RI** cable and analog audio cable are connected properly. Connecting only an **RI** cable won't work (page 17).
- With some components, certain buttons may not work as expected, and some may not work at all.
- To control an Onkyo component that's connected via **RI**, point the remote controller at the receiver.

### Recording

#### Can't record

- On your recorder, make sure the correct input is selected.
- To prevent signal loops and damage to the receiver, input signals are not fed through to outputs with the same name (e.g., TAPE IN to TAPE OUT).

### Others

#### The **RI** functions don't work

- To use **RI**, you must make an **RI** connection and an analog audio connection (RCA) between the component and receiver, even if they are connected digitally (page 17).

The receiver contains a microcomputer for signal processing and control functions. In very rare situations, severe interference, noise from an external source, or static electricity may cause it to lockup. In the unlikely event that this happens, unplug the power cord from the wall outlet, wait at least five seconds, and then plug it back in again.

Onkyo is not responsible for damages (such as CD rental fees) due to unsuccessful recordings caused by the unit's malfunction. Before you record important data, make sure that the material will be recorded correctly.

Before disconnecting the power cord from the wall outlet, set the receiver to Standby.

#### Memory Backup

The receiver uses a battery-less memory backup system in order to retain radio presets and other settings when it's unplugged or in the case of a power failure. Although no batteries are required, the receiver must be plugged into an AC outlet in order to charge the backup system. Once it has been charged, the receiver will retain the settings for several weeks, although this depends on the environment and will be shorter in humid climates.



# Specifications

---

## Amplifier Section

---

Rated Output Power (FTC) (North American) <b>All channels:</b>	<b>50 watts minimum continuous power per channel, 8 ohm loads, 2 channels driven from 20 Hz to 20 kHz, with a maximum total harmonic distortion of 0.08 %</b>
Rated Output Power (IEC) (European and Australian)	2 ch × 90 W at 4 ohms, 1 kHz, 1 ch driven
Maximum Output Power (JEITA) (Asian)	90 W at 4 ohms, 1 kHz, 2 ch driven
Dynamic Power	
North American:	135 W + 135 W (2 Ω) 105 W + 105 W (4 Ω) 70 W + 70 W (8 Ω)
European and Australian:	110 W + 110 W (2 Ω) 90 W + 90 W (4 Ω) 55 W + 55 W (8 Ω)
THD (Total Harmonic Distortion)	0.08 % (Power Rated)/ 0.08 % (1 kHz, 1 W)
Damping Factor	60 (Front, 1 kHz, 8 Ω)
Input Sensitivity and Impedance	150 mV/ 50 kΩ (LINE) 2.5 mV/ 50 kΩ (PHONO MM)
Output Level and Impedance	150 mV/ 2.2 kΩ (REC OUT)
Frequency Response	10 Hz–100 kHz/ +1 dB–3 dB (CD)
Tone Control	±10 dB, 100 Hz (BASS) ±10 dB, 10 kHz (TREBLE)
Signal to Noise Ratio	100 dB (LINE, IHF-A) 80 dB (PHONO, IHF-A)
Speaker Impedance	4 Ω–16 Ω

## Tuner Section

---

### ■ FM

Tuning Frequency Range	North American: 87.5 MHz– 107.9 MHz Others: 87.5 MHz– 108.0 MHz
------------------------	--

### ■ AM

Tuning Frequency Range	North American: 530 kHz–1710 kHz Others: 522 kHz–1611 kHz
------------------------	--

Preset Channel	40
----------------	----

## General

---

Power Supply	North American: AC 120 V, 60 Hz European: AC 230-240 V, 50 Hz Others: AC 230-240 V, 50Hz
Power Consumption	North American: 2.1 A European: 180 W Others: 180 W
Standby Power Consumption	North American: 0.2 W Others: 0.3 W
Dimensions (W × H × D)	435 × 149 × 340 mm 17-1/8" × 5-7/8" × 13-3/8"
Weight	7.5 kg 16.5 lbs.

### ■ Audio Inputs

Analog Inputs	PHONO, CD, TAPE 1, TAPE 2, LINE 1, LINE 2
---------------	---

### ■ Audio Outputs

Analog Outputs	TAPE 1, TAPE 2
Speaker Outputs	SPEAKERS A SPEAKERS B
Phones	1
IR Input/Output	1/1

Specifications and features are subject to change without notice.



# MEMO

---

## **ONKYO CORPORATION**

Sales & Product Planning Div. : 2-1, Nisshin-cho, Neyagawa-shi, OSAKA 572-8540, JAPAN  
Tel: 072-831-8023 Fax: 072-831-8124

### **ONKYO U.S.A. CORPORATION**

18 Park Way, Upper Saddle River, N.J. 07458, U.S.A.  
Tel: 201-785-2600 Fax: 201-785-2650 <http://www.us.onkyo.com/>

### **ONKYO EUROPE ELECTRONICS GmbH**

Liegnitzerstrasse 6, 82194 Groebenzell, GERMANY  
Tel: +49-8142-4401-0 Fax: +49-8142-4401-555 <http://www.eu.onkyo.com/>

### **ONKYO EUROPE UK Office**

Suite 1, Gregories Court, Gregories Road, Beaconsfield, Buckinghamshire, HP9 1HQ  
UNITED KINGDOM Tel: +44-(0)1494-681515 Fax: +44(0)-1494-680452

### **ONKYO CHINA LIMITED**

Units 2102-2107, Metroplaza Tower I, 223 Hing Fong Road, Kwai Chung,  
N.T., HONG KONG Tel: 852-2429-3118 Fax: 852-2428-9039  
<http://www.ch.onkyo.com/>



D0805-1

SN 29344818

(C) Copyright 2008 ONKYO CORPORATION Japan. All rights reserved.

