

ONKYO®

AV Receiver

HT-R690

Instruction Manual

Thank you for purchasing an Onkyo AV Receiver. Please read this manual thoroughly before making connections and plugging in the unit. Following the instructions in this manual will enable you to obtain optimum performance and listening enjoyment from your new AV Receiver. Please retain this manual for future reference.

Contents

Introduction2

Connections.....11

Turning On & Basic Operations20

Advanced Operations39

Controlling Other Components...58

Appendix64



WARNING:

TO REDUCE THE RISK OF FIRE OR ELECTRIC SHOCK, DO NOT EXPOSE THIS APPARATUS TO RAIN OR MOISTURE.

CAUTION:

TO REDUCE THE RISK OF ELECTRIC SHOCK, DO NOT REMOVE COVER (OR BACK). NO USER-SERVICEABLE PARTS INSIDE. REFER SERVICING TO QUALIFIED SERVICE PERSONNEL.



WARNING
RISK OF ELECTRIC SHOCK
DO NOT OPEN

AVIS
RISQUE DE CHOC ELECTRIQUE
NE PAS OUVRIR



The lightning flash with arrowhead symbol, within an equilateral triangle, is intended to alert the user to the presence of uninsulated "dangerous voltage" within the product's enclosure that may be of sufficient magnitude to constitute a risk of electric shock to persons.



The exclamation point within an equilateral triangle is intended to alert the user to the presence of important operating and maintenance (servicing) instructions in the literature accompanying the appliance.

Important Safety Instructions

1. Read these instructions.
2. Keep these instructions.
3. Heed all warnings.
4. Follow all instructions.
5. Do not use this apparatus near water.
6. Clean only with dry cloth.
7. Do not block any ventilation openings. Install in accordance with the manufacturer's instructions.
8. Do not install near any heat sources such as radiators, heat registers, stoves, or other apparatus (including amplifiers) that produce heat.
9. Do not defeat the safety purpose of the polarized or grounding-type plug. A polarized plug has two blades with one wider than the other. A grounding type plug has two blades and a third grounding prong. The wide blade or the third prong are provided for your safety. If the provided plug does not fit into your outlet, consult an electrician for replacement of the obsolete outlet.
10. Protect the power cord from being walked on or pinched particularly at plugs, convenience receptacles, and the point where they exit from the apparatus.
11. Only use attachments/accessories specified by the manufacturer.
12. Use only with the cart, stand, tripod, bracket, or table specified by the manufacturer, or sold with the apparatus. When a cart is used, use caution when moving the cart/apparatus combination to avoid injury from tip-over.

PORTABLE CART WARNING
S3125A
13. Unplug this apparatus during lightning storms or when unused for long periods of time.
14. Refer all servicing to qualified service personnel. Servicing is required when the apparatus has been damaged in any way, such as power-supply cord or plug is damaged, liquid has been spilled or objects have fallen into the apparatus, the apparatus has been exposed to rain or moisture, does not operate normally, or has been dropped.
15. Damage Requiring Service
Unplug the apparatus from the wall outlet and refer servicing to qualified service personnel under the following conditions:
 - A. When the power-supply cord or plug is damaged,
 - B. If liquid has been spilled, or objects have fallen into the apparatus,
 - C. If the apparatus has been exposed to rain or water,
 - D. If the apparatus does not operate normally by following the operating instructions. Adjust only those controls that are covered by the operating instructions as an improper adjustment of other controls may result in damage and will often require extensive work by a qualified technician to restore the apparatus to its normal operation,
 - E. If the apparatus has been dropped or damaged in any way, and
 - F. When the apparatus exhibits a distinct change in performance this indicates a need for service.
16. Object and Liquid Entry
Never push objects of any kind into the apparatus through openings as they may touch dangerous voltage points or short-out parts that could result in a fire or electric shock.
The apparatus shall not be exposed to dripping or splashing and no objects filled with liquids, such as vases shall be placed on the apparatus.
Don't put candles or other burning objects on top of this unit.
17. Batteries
Always consider the environmental issues and follow local regulations when disposing of batteries.
18. If you install the apparatus in a built-in installation, such as a bookcase or rack, ensure that there is adequate ventilation.
Leave 20 cm (8") of free space at the top and sides and 10 cm (4") at the rear. The rear edge of the shelf or board above the apparatus shall be set 10 cm (4") away from the rear panel or wall, creating a flue-like gap for warm air to escape.

Precautions

- 1. Recording Copyright**—Unless it's for personal use only, recording copyrighted material is illegal without the permission of the copyright holder.
- 2. AC Fuse**—The AC fuse inside the unit is not user-serviceable. If you cannot turn on the unit, contact your Onkyo dealer.
- 3. Care**—Occasionally you should dust the unit all over with a soft cloth. For stubborn stains, use a soft cloth dampened with a weak solution of mild detergent and water. Dry the unit immediately afterwards with a clean cloth. Don't use abrasive cloths, thinners, alcohol, or other chemical solvents, because they may damage the finish or remove the panel lettering.

4. Power

WARNING

BEFORE PLUGGING IN THE UNIT FOR THE FIRST TIME, READ THE FOLLOWING SECTION CAREFULLY.

AC outlet voltages vary from country to country. Make sure that the voltage in your area meets the voltage requirements printed on the unit's rear panel (e.g., AC 230 V, 50 Hz or AC 120 V, 60 Hz).

The power cord plug is used to disconnect this unit from the AC power source. Make sure that the plug is readily operable (easily accessible) at all times.

Pressing the [ON/STANDBY] button to select Standby mode does not fully disconnect from the mains. If you do not intend to use the unit for an extended period, remove the power cord from the AC outlet.

5. Preventing Hearing Loss

Caution

Excessive sound pressure from earphones and headphones can cause hearing loss.

6. Batteries and Heat Exposure

Warning

Batteries (battery pack or batteries installed) shall not be exposed to excessive heat as sunshine, fire or the like.

7. Never Touch this Unit with Wet Hands

—Never handle this unit or its power cord while your hands are wet or damp. If water or any other liquid gets inside this unit, have it checked by your Onkyo dealer.

8. Handling Notes

- If you need to transport this unit, use the original packaging to pack it how it was when you originally bought it.
- Do not leave rubber or plastic items on this unit for a long time, because they may leave marks on the case.
- This unit's top and rear panels may get warm after prolonged use. This is normal.
- If you do not use this unit for a long time, it may not work properly the next time you turn it on, so be sure to use it occasionally.

For U.S. models

FCC Information for User

CAUTION:

The user changes or modifications not expressly approved by the party responsible for compliance could void the user's authority to operate the equipment.

NOTE:

This equipment has been tested and found to comply with the limits for a Class B digital device, pursuant to Part 15 of the FCC Rules. These limits are designed to provide reasonable protection against harmful interference in a residential installation.

This equipment generates, uses and can radiate radio frequency energy and, if not installed and used in accordance with the instructions, may cause harmful interference to radio communications. However, there is no guarantee that interference will not occur in a particular installation. If this equipment does cause harmful interference to radio or television reception, which can be determined by turning the equipment off and on, the user is encouraged to try to correct the interference by one or more of the following measures:

- Reorient or relocate the receiving antenna.
- Increase the separation between the equipment and receiver.
- Connect the equipment into an outlet on a circuit different from that to which the receiver is connected.
- Consult the dealer or an experienced radio/TV technician for help.

For Canadian Models

NOTE: THIS CLASS B DIGITAL APPARATUS COMPLIES WITH CANADIAN ICES-003.

For models having a power cord with a polarized plug:

CAUTION: TO PREVENT ELECTRIC SHOCK, MATCH WIDE BLADE OF PLUG TO WIDE SLOT, FULLY INSERT.

Modèle pour les Canadien

REMARQUE: CET APPAREIL NUMÉRIQUE DE LA CLASSE B EST CONFORME À LA NORME NMB-003 DU CANADA.

Sur les modèles dont la fiche est polarisée:

ATTENTION: POUR ÉVITER LES CHOCS ÉLECTRIQUES, INTRODUIRE LA LAME LA PLUS LARGE DE LA FICHE DANS LA BORNE CORRESPONDANTE DE LA PRISE ET POUSSER JUSQU'AU FOND.

Supplied Accessories

Make sure you have the following accessories:

Indoor FM antenna (→ page 19)

AM loop antenna (→ page 19)

Speaker setup microphone (→ page 28)

Remote controller (RC-801M) and two batteries (AA/R6)

* In catalogs and on packaging, the letter at the end of the product name indicates the color. Specifications and operations are the same regardless of color.

■ Installing the batteries

Note

- If the remote controller doesn't work reliably, try replacing the batteries.
- Don't mix new and old batteries or different types of batteries.
- If you intend not to use the remote controller for a long time, remove the batteries to prevent damage from leakage or corrosion.
- Remove expired batteries as soon as possible to prevent damage from leakage or corrosion.

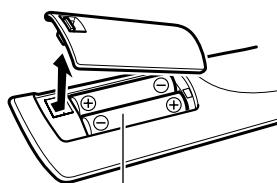

Batteries (AA/R6)

■ Aiming the remote controller

To use the remote controller, point it at the AV receiver's remote control sensor, as shown below.

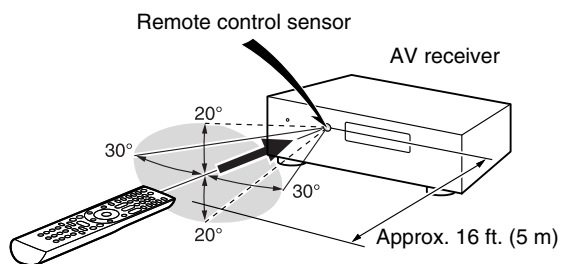

Contents

Introduction

Important Safety Instructions	2
Precautions.....	3
Supplied Accessories.....	4
Features	6
Front & Rear Panels.....	7
Front Panel.....	7
Display.....	8
Rear Panel	9
Remote Controller.....	10
Controlling the AV Receiver	10

Connections

Connecting the AV Receiver.....	11
Connecting Your Speakers	11
About AV Connections	14
Connecting Components with HDMI	15
Connecting Your Components	16
Connecting Onkyo RI Components	18
Connecting a Recording Component	18
Connecting the Antennas	19
Connecting the Power Cord	19

Turning On & Basic Operations

Turning On/Off the AV Receiver	20
Turning On	20
Turning Off	20
Playback.....	21
Selecting the Language for the Onscreen Setup Menus	21
Playing the Connected Component.....	21
Controlling Contents of USB or Network Devices	21
Understanding Icons on the Display.....	22
Playing an iPod/iPhone via USB	22
Playing a USB Device	23
Listening to Internet Radio	23
Playing Music Files on a Server	25
Remote Playback	25
Listening to AM/FM Radio	26
Using Basic Functions	28
Using the Automatic Speaker Setup	28
Using the Listening Modes	31
Using the Home Menu.....	36
Using the Sleep Timer.....	36
Setting the Display Brightness	36
Displaying Source Information	37
Changing the Input Display	37
Using the Music Optimizer	37
Muting the AV Receiver.....	37
Using Headphones.....	38
Recording	38

Advanced Operations

Advanced Setup	39
On-screen Setup Menus.....	39
Common Procedures in Setup Menu	39
Input/Output Assign	40
Speaker Setup	41
Audio Adjust	44
Source Setup.....	45
Listening Mode Preset.....	50
Miscellaneous	50
Hardware Setup.....	51
Remote Controller Setup	54
Lock Setup.....	54
Using the Audio Settings	54
Zone 2.....	56
Making Zone 2 Connections.....	56
Controlling Zone 2 Components.....	57

Controlling Other Components

iPod/iPhone Playback via Onkyo Dock	58
Using the Onkyo Dock.....	58
Controlling Your iPod/iPhone	59
Controlling Other Components.....	61
Preprogrammed Remote Control Codes	61
Looking up for Remote Control Code	61
Entering Remote Control Codes.....	61
Remote Control Codes for Onkyo Components Connected via RI	62
Resetting REMOTE MODE Buttons	62
Resetting the Remote Controller	62
Controlling Other Components	62

Appendix

Troubleshooting	64
Network/USB Features.....	70
Firmware Update	73
Connection Tips and Video Signal Path	76
About HDMI.....	78
Using an RIHD-compatible TV, Player, or Recorder.....	79
Specifications	81
Video Resolution Chart.....	82

To reset the AV receiver to its factory defaults, turn it on and, while holding down VCR/DVR, press **⏻ ON/STANDBY** (→ page 64).

Features

Amplifier

- 130 Watts/Channel @ 6 ohms (FTC)
- Optimum Gain Volume Circuitry
- H.C.P.S. (High Current Power Supply) Massive High Power Transformer
- Jitter Cleaning Circuit Technology

Processing

- Incorporates Qdeo™*1 technology for HDMI Video Upscaling (to 4K Compatible).
- HDMI (Audio Return Channel, 3D, DeepColor, x.v.Color*2, Lip Sync, DTS-HD Master Audio*3, DTS-HD High Resolution Audio, Dolby TrueHD*4, Dolby Digital Plus, DSD and Multi-CH PCM)
- Dolby TrueHD*4 and DTS-HD Master Audio*3
- Dolby Pro Logic IIz*4
- Non-Scaling Configuration
- A-Form Listening Mode Memory
- Direct Mode
- Music Optimizer*5 for Compressed Digital Music files
- 192 kHz/24-bit D/A Converters
- Powerful and Highly Accurate 32-bit Processing DSP

Connections

- 4 HDMI*6 Inputs and 1 Output
- Onkyo **RIHD** for System Control
- 4 Digital Inputs (2 Optical/2 Coaxial)
- Component Video Switching (2 Inputs/1 Output)
- Universal Port for the Dock for iPod®/iPhone®*7/ HD Radio™*8 tuner module
- Powered Zone 2
- Analog RGB Video Input (D-sub 15) for PC
- Internet Radio Connectivity (SiriusXM Internet Radio/vTuner/Last.fm/Pandora/Rhapsody/Slacker/Mediafly/Napster)
- * Services available may vary depending on the region.
- Network Capability for Streaming Audio Files*9
- Front-Panel USB Input for Memory Devices and iPod®/iPhone®*7 models (Enables Display of Album Artwork)

Miscellaneous

- 40 AM/FM Presets
- Audyssey 2EQ®*10 to correct room acoustic problems
- Audyssey Dynamic EQ®*10 for loudness correction
- Audyssey Dynamic Volume®*10 to maintain optimal listening level and dynamic range
- Crossover Adjustment (40/50/60/70/80/90/100/120/150/200 Hz)
- A/V Sync Control Function (up to 800 ms)
- Auto Standby Function
- On-Screen Display via HDMI
- Preprogrammed **RI**-Compatible Remote

*1 Qdeo and QuietVideo are trademarks of Marvell or its affiliates.

*2 “x.v.Color” is a trademark of Sony Corporation.

*3  **DTS-HD Master Audio**

Manufactured under license under U.S. Patent #'s: 5,451,942; 5,956,674; 5,974,380; 5,978,762; 6,226,616; 6,487,535; 7,212,872; 7,333,929; 7,392,195; 7,272,567 & other U.S. and worldwide patents issued & pending. DTS and the Symbol are registered trademarks, & DTS-HD, DTS-HD Master Audio, and the DTS logos are trademarks of DTS, Inc. Product includes software.

© DTS, Inc. All Rights Reserved.

*4  **DOLBY TRUEHD PRO LOGIC IIz**

Manufactured under license from Dolby Laboratories. Dolby, Pro Logic and the double-D symbol are trademarks of Dolby Laboratories.

*5 Music Optimizer™ is a trademark of Onkyo Corporation.

*6  **HDMI**

“HDMI, the HDMI Logo, and High-Definition Multimedia Interface are trademarks or registered trademarks of HDMI Licensing LLC in the United States and other countries.”

*7



iPhone, iPod, iPod classic, iPod nano, iPod shuffle, and iPod touch are trademarks of Apple Inc., registered in the U.S. and other countries.

“Made for iPod” and “Made for iPhone” mean that an electronic accessory has been designed to connect specifically to iPod or iPhone, respectively, and has been certified by the developer to meet Apple performance standards. Apple is not responsible for the operation of this device or its compliance with safety and regulatory standards.

Please note that the use of this accessory with iPod or iPhone may affect wireless performance.

*8  **HD Radio READY**

HD Radio™, HD Radio Ready™, and the HD Radio Ready logo are proprietary trademarks of iBiquity Digital Corporation.

This HD Radio Ready™ receiver is ready to receive HD Radio broadcasts when connected to the Onkyo UP-HT1 HD Radio tuner module (sold separately).

*9 “DLNA®, the DLNA Logo and DLNA CERTIFIED™ are trademarks, service marks, or certification marks of the Digital Living Network Alliance.”

*9 Windows and the Windows logo are trademarks of the Microsoft group of companies.

*10  **AUDYSSEY 2EQ DYNAMIC VOLUME**

Manufactured under license from Audyssey Laboratories™, Inc. U.S. and foreign patents pending. Audyssey 2EQ®, Audyssey Dynamic EQ® and Audyssey Dynamic Volume® are registered trademarks of Audyssey Laboratories, Inc.

Front & Rear Panels

Front Panel

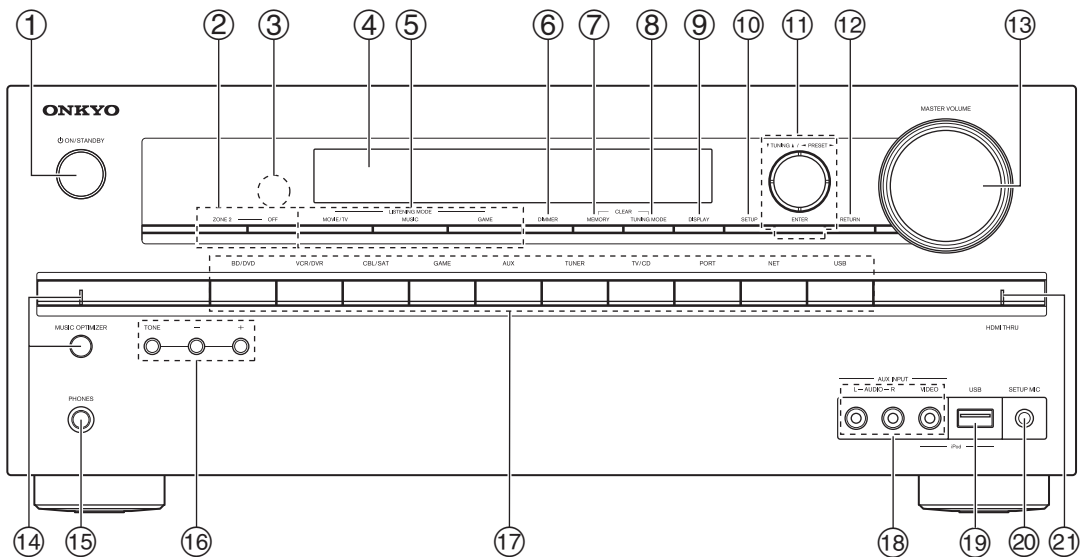

The page numbers in parentheses show where you can find the main explanation for each item.

- | | |
|--|--|
| ① ON/STANDBY button (20) | ⑫ RETURN button |
| ② ZONE 2, OFF buttons (57) | ⑬ MASTER VOLUME control (21) |
| ③ Remote control sensor (4) | ⑭ MUSIC OPTIMIZER button and indicator (37, 55) |
| ④ Display (8) | ⑮ PHONES jack (38) |
| ⑤ LISTENING MODE buttons (31) | ⑯ TONE and Tone Level buttons (54) |
| ⑥ DIMMER button (36) | ⑰ Input selector buttons (21) |
| ⑦ MEMORY button (27) | ⑱ AUX INPUT AUDIO/VIDEO jacks (16) |
| ⑧ TUNING MODE button (26) | ⑲ USB port (16) |
| ⑨ DISPLAY button (37) | ⑳ SETUP MIC jack (28) |
| ⑩ SETUP button (39) | ㉑ HDMI THRU indicator (52) |
| ⑪ TUNING, PRESET (26 to 27), arrow and ENTER buttons | |

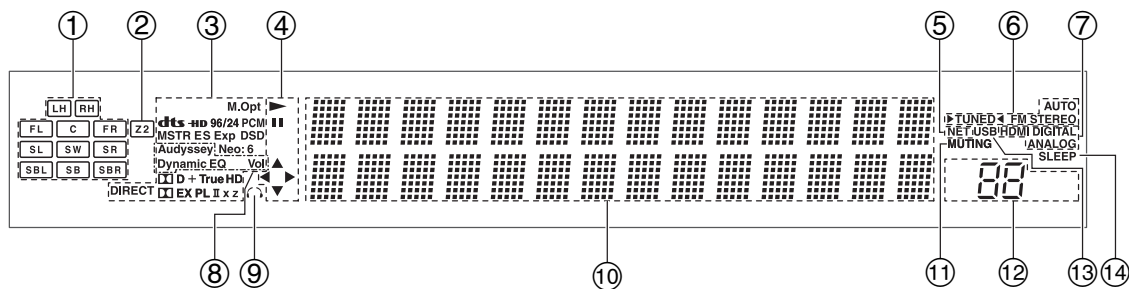

For detailed information, see the pages in parentheses.

- ① **Speaker/channel indicators**
- ② **Z2 (Zone 2) indicator** (57)
- ③ **Listening mode and format indicators** (31, 55)
- ④ **►, || and cursor indicators** (22)
- ⑤ **NET indicator** (23, 53)
- ⑥ **Tuning indicators**
AUTO indicator (26)
TUNED indicator (26)
FM STEREO indicator (26)
- ⑦ **Audio input indicators**
- ⑧ **Audyssey indicator** (28, 45)
Dynamic EQ indicator (45)
Dynamic Vol indicator (46)
- ⑨ **Headphone indicator** (38)
- ⑩ **Message area**
- ⑪ **MUTING indicator** (37)
- ⑫ **Volume level** (21)
- ⑬ **USB indicator** (22, 23)
- ⑭ **SLEEP indicator** (36, 49)

Rear Panel

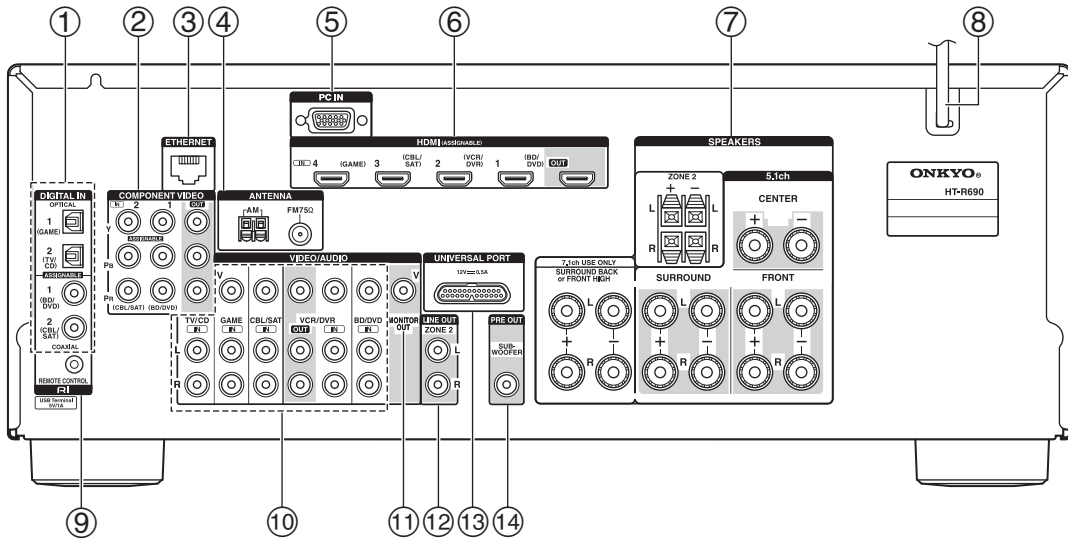

- ① **DIGITAL IN COAXIAL and OPTICAL** jacks
- ② **COMPONENT VIDEO IN and OUT** jacks
- ③ **ETHERNET** port
- ④ **FM ANTENNA** jack and **AM ANTENNA** terminal
- ⑤ **PC IN** jack
- ⑥ **HDMI IN and OUT** jacks
- ⑦ **SPEAKERS** terminals
(**CENTER, FRONT, SURROUND, SURROUND BACK or FRONT HIGH, ZONE 2**)
- ⑧ **Power cord**
- ⑨ **RI REMOTE CONTROL** jack
- ⑩ **Composite video and analog audio jacks**
(**BD/DVD IN, VCR/DVR IN and OUT, CBL/SAT IN, GAME IN, TV/CD IN**)
- ⑪ **MONITOR OUT V** jack
- ⑫ **ZONE 2 LINE OUT** jacks
- ⑬ **UNIVERSAL PORT** jack
- ⑭ **SUBWOOFER PRE OUT** jack

See “Connecting the AV Receiver” for connection
(→ **pages 11 to 19**).

Remote Controller

Controlling the AV Receiver

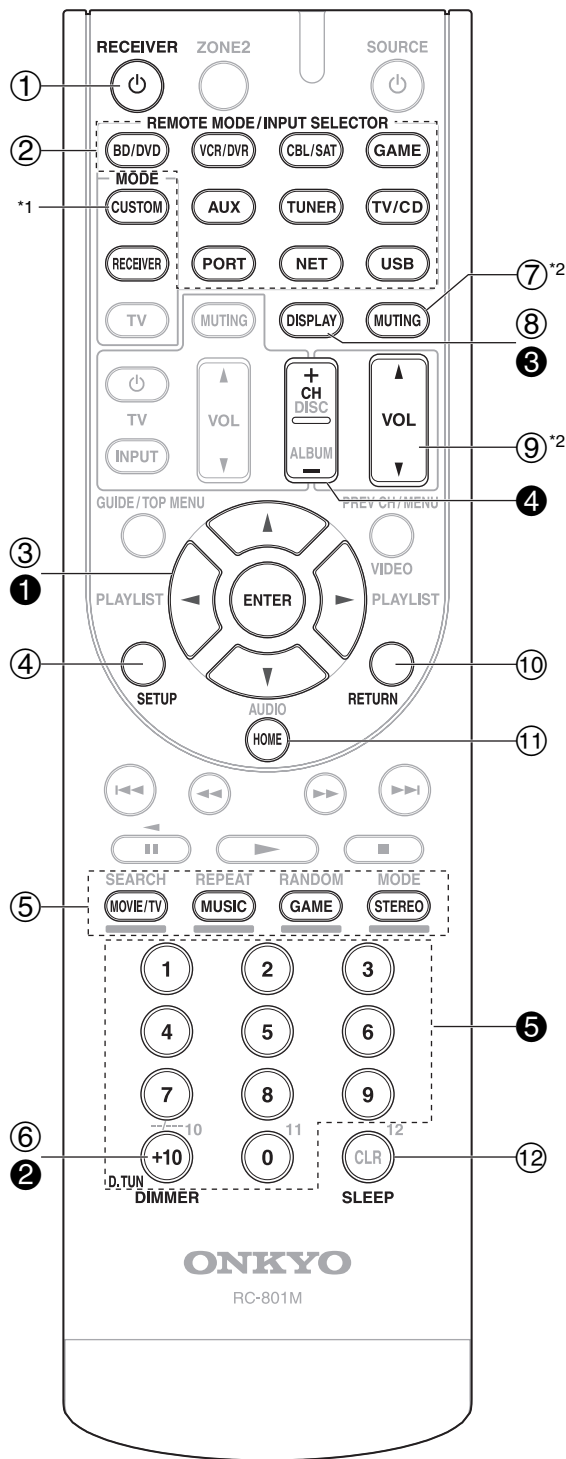

To control the AV receiver, press **RECEIVER** to select Receiver mode.
 You can also use the remote controller to control Onkyo Blu-ray Disc/DVD player, CD player, and other components.
 See “Entering Remote Control Codes” for more details (→ page 61).

For detailed information, see the pages in parentheses.

- ① **RECEIVER** button (20)
- ② **REMOTE MODE/INPUT SELECTOR** buttons (21)
- ③ Arrow **▲/▼/◀/▶** and **ENTER** buttons
- ④ **SETUP** button (39)
- ⑤ Listening Mode buttons (31)
- ⑥ **DIMMER** button (36)
- ⑦ **MUTING** button (37)
- ⑧ **DISPLAY** button (37)
- ⑨ **VOL ▲/▼** button (21)
- ⑩ **RETURN** button
- ⑪ **HOME** button (36, 54)
- ⑫ **SLEEP** button (36)

■ Controlling the tuner

To control the AV receiver’s tuner, press **TUNER** (or **RECEIVER**).

You can select AM or FM by pressing **TUNER** repeatedly.

- ① Arrow **▲/▼** buttons (26)
- ② **D.TUN** button (27)
- ③ **DISPLAY** button
- ④ **CH +/-** button (27)
- ⑤ **Number** buttons (27)

*1 To control component, you must first enter remote control code.
 See “Entering Remote Control Codes” for more details (→ page 61).

*2 These buttons can be used when not in receiver mode, and when a **REMOTE MODE** other than receiver mode is selected.

Connecting the AV Receiver

Connecting Your Speakers

Connecting the Speaker Cables

The following illustration shows which speaker should be connected to each pair of terminals. If you're using only one surround back speaker, connect it to the **SURROUND BACK** or **FRONT HIGH L** terminals.

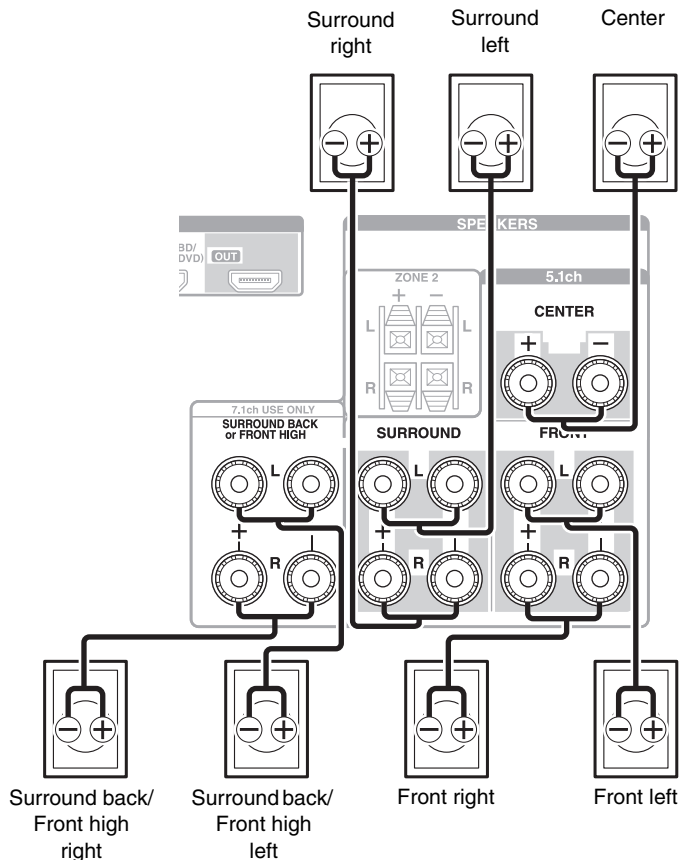

Tip

- You can specify whether surround back or front high speakers are connected in the “Speaker Configuration” menu (→ [page 42](#)) or during Audyssey 2EQ® Room Correction and Speaker Setup (→ [page 28](#)).
- The speakers you can connect will differ depending on the speaker system that you have.

■ Screw-type speaker terminals

Strip 1/2" to 5/8" (12 to 15 mm) of insulation from the ends of the speaker cables, and twist the bare wires tightly, as shown. (Supplied speaker cables are already stripped.)

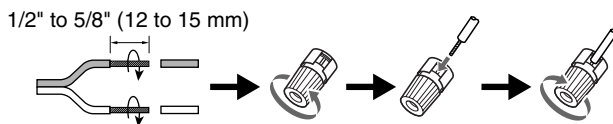

■ Push-type speaker terminals

Strip 3/8" to 1/2" (10 to 12 mm) of insulation from the ends of the speaker cables, and twist the bare wires tightly, as shown. (Supplied speaker cables are already stripped.)

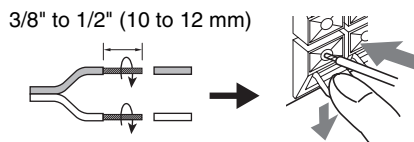

Speaker Configuration

The following table indicates the channels you should use depending on the number of speakers that you have.

No matter how many speakers you use, a powered subwoofer is recommended for a really powerful and solid bass.

To get the best from your surround sound system, you need to set the speaker settings automatically (→ **page 28**) or manually (→ **page 41**).

Number of channels	2	3	4	5	6	7	7
Front speakers	✓	✓	✓	✓	✓	✓	✓
Center speaker			✓	✓	✓	✓	✓
Surround speakers				✓	✓	✓	✓
Surround back speaker*1*2					✓		
Surround back speakers*2						✓	
Front high speakers*2							✓

*1 If you're using only one surround back speaker, connect it to the **SURROUND BACK** or **FRONT HIGH L** terminals.

*2 Front high and surround back speakers cannot be used at the same time.

Connecting the Speaker Cables

The speaker terminals are color-coded for identification purpose.

Speaker	Color
Front left, Zone 2 left	White
Front right, Zone 2 right	Red
Center	Green
Surround left	Blue
Surround right	Gray
Surround back left, Front high left	Brown
Surround back right, Front high right	Tan

Speaker Connection Precautions

Read the following before connecting your speakers:

- You can connect speakers with an impedance of between 6 and 16 ohms. If you use speakers with a lower impedance, and use the amplifier at high volume levels for a long period of time, the built-in amp protection circuit may be activated.
- Disconnect the power cord from the wall outlet before making any connections.
- Read the instructions supplied with your speakers.
- Pay close attention to speaker wiring polarity. In other words, connect positive (+) terminals only to positive (+) terminals, and negative (–) terminals only to negative (–) terminals. If you get them the wrong way around, the sound will be out of phase and will sound unnatural.
- Unnecessarily long, or very thin speaker cables may affect the sound quality and should be avoided.
- Be careful not to short the positive and negative wires. Doing so may damage the AV receiver.
- Make sure the metal core of the wire does not have contact with the AV receiver's rear panel. Doing so may damage the AV receiver.

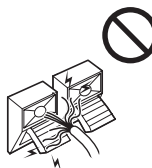
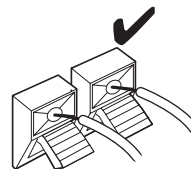
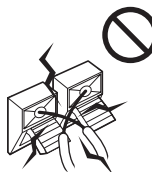
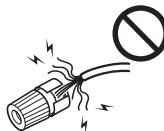
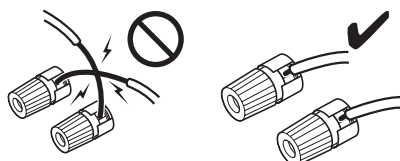

- Don't connect more than one cable to each speaker terminal. Doing so may damage the AV receiver.
- Don't connect one speaker to several terminals.

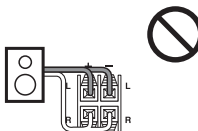
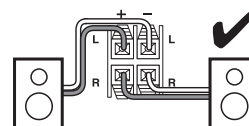
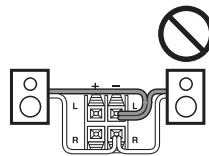
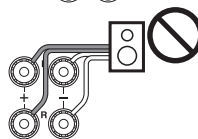
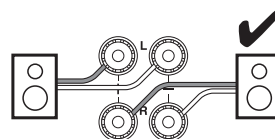
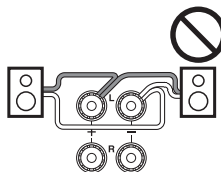

Using a Powered Subwoofer

To find the best position for your subwoofer, while playing a movie or some music with good bass, experiment by placing your subwoofer at various positions within the room, and choose the one that provides the most satisfying results.

Tip

- If your subwoofer is unpowered and you're using an external amplifier, connect the subwoofer pre out jack to an input on the amplifier.

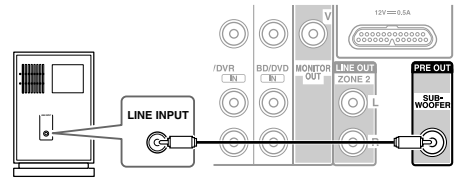

Powered subwoofer

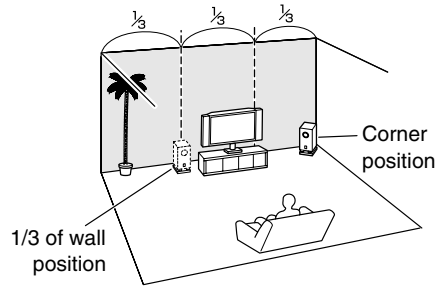

Connecting AV components

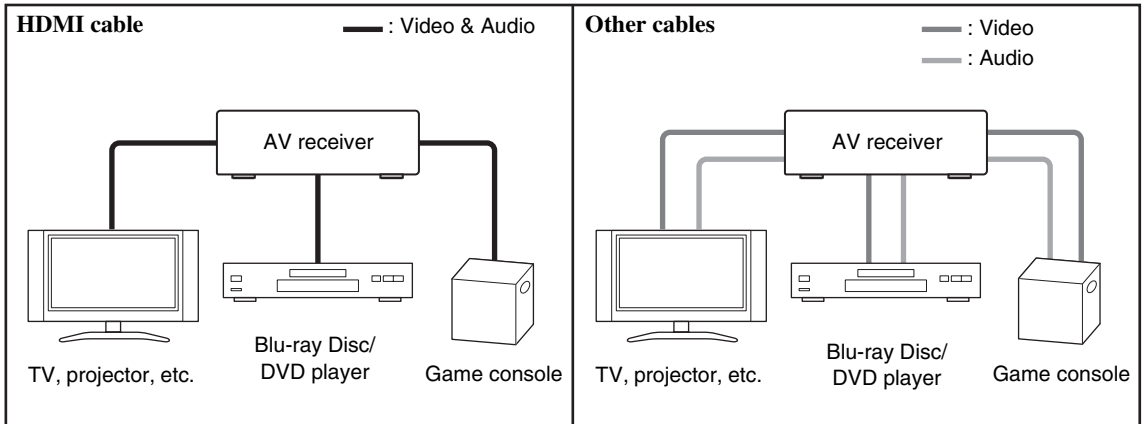

- Before making any AV connections, read the manuals supplied with your AV components.
- Don't connect the power cord until you've completed and double-checked all AV connections.
- Push plugs in all the way to make good connections (loose connections can cause noise or malfunctions).
- To prevent interference, keep audio and video cables away from power cords and speaker cables.

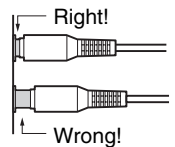

AV Cables and Jacks

Signal	Cable	Jack	Description
Video and Audio	HDMI	HDMI	HDMI connections can carry digital video and audio.
Video	Component video	Y Green PB Blue PR Red	Component video separates the luminance (Y) and color difference signals (PB, PR), providing the best picture quality (some TV manufacturers label their component video sockets slightly differently).
	Analog RGB	D-Sub	This is a conventional analog interface to connect a PC and a display device (also called D-Sub or D-subminiature).
	Composite video	V Yellow	Composite video is commonly used on TVs, VCRs, and other video equipment.
Audio	Optical digital audio	OPTICAL	Optical digital connections allow you to enjoy digital sound such as PCM*, Dolby Digital or DTS. The audio quality is the same as coaxial.
	Coaxial digital audio	COAXIAL Orange	Coaxial digital connections allow you to enjoy digital sound such as PCM*, Dolby Digital or DTS. The audio quality is the same as optical.
	Analog audio (RCA)	L White R Red	Analog audio connections (RCA) carry analog audio.

* Available sampling rate for PCM input signal (stereo/mono) is 32/44.1/48/88.2/96 kHz. In case of an HDMI connection, 176.4/192 kHz is also available.

Note

- The AV receiver does not support SCART plugs.
- The AV receiver's optical digital jacks have shutter-type covers that open when an optical plug is inserted and close when it's removed. Push plugs in all the way.

Caution

- To prevent shutter damage, hold the optical plug straight when inserting and removing.

Connecting Components with HDMI

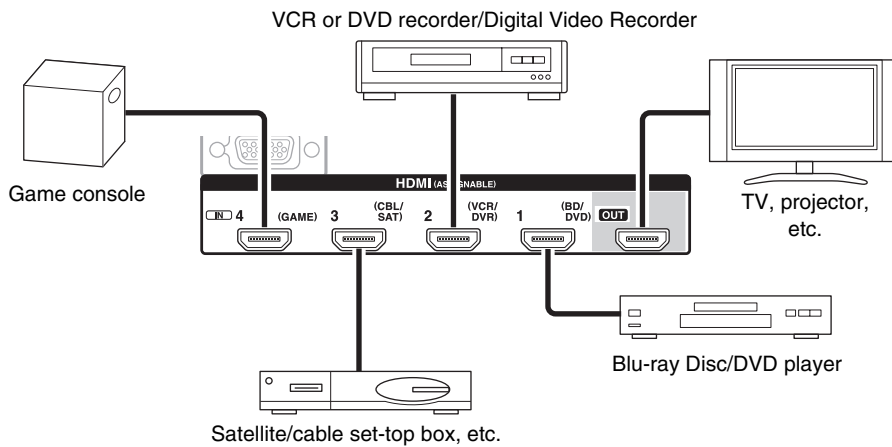

Connect your components to the appropriate jacks. The default input assignments are shown below.

✓: Assignment can be changed (→ page 40).

Jack	Components	Assignable
Input	HDMI IN 1	Blu-ray Disc/DVD player ✓
	HDMI IN 2	VCR or DVD recorder/Digital Video Recorder ✓
	HDMI IN 3	Satellite/cable set-top box, etc. ✓
	HDMI IN 4	Game console ✓
Output	HDMI OUT	TV, projector, etc.

See also:

- “Connection Tips and Video Signal Path” (→ page 76)
- “About HDMI” (→ page 78)
- “Using an RIHD-compatible TV, Player, or Recorder” (→ page 79)

■ Audio Return Channel (ARC) function

Audio Return Channel (ARC) function enables an HDMI capable TV to send the audio stream to the **HDMI OUT** of the AV receiver.

- This function can be used when:
 - your TV is ARC capable, and
 - the **TV/CD** input selector is selected, and
 - **HDMI Control (RIHD)** is set to “On” (→ page 51), and
 - **Audio Return Channel** is set to “Auto” (→ page 52).

Tip

- To listen to audio received by the **HDMI IN** jacks through your TV’s speakers:
 - Set the **HDMI Control (RIHD)** setting to “On” (→ page 51) for an **RIHD**-compatible TV.
 - Set the **Audio TV Out** setting to “On” (→ page 52) when the TV is not compatible with **RIHD**, or the **HDMI Control (RIHD)** setting to “Off”.
 - Set your Blu-ray Disc/DVD player’s HDMI audio output setting to PCM.
 - To listen to TV audio through the AV receiver, see “Connecting Your Components” (→ page 16).

Note

- When listening to an HDMI component through the AV receiver, set the HDMI component so that its video can be seen on the TV screen (on the TV, select the input of the HDMI component connected to the AV receiver). If the TV power is off or the TV is set to another input source, this may result in no sound from the AV receiver or the sound may be cut off.
- As the **Audio TV Out** setting is set to “On” (→ page 52) to hear from your TV speakers, the sound will also be output from the AV receiver’s speakers if you adjust the volume of the AV receiver. Similarly, as the **HDMI Control (RIHD)** setting is set to “On” (→ page 51) to hear from the speakers of an **RIHD**-compatible TV, the AV receiver’s speakers will produce sound if you adjust the volume of the AV receiver, while the TV speakers will be muted. To stop the AV receiver’s speakers from producing sound, you can either change the settings on the AV receiver or on the TV, or turn down the volume of the AV receiver.

Connecting Your Components

The on-screen menus appear only on a TV that is connected to the **HDMI OUT**. If your TV is connected to other video outputs, use the AV receiver's display when changing settings.

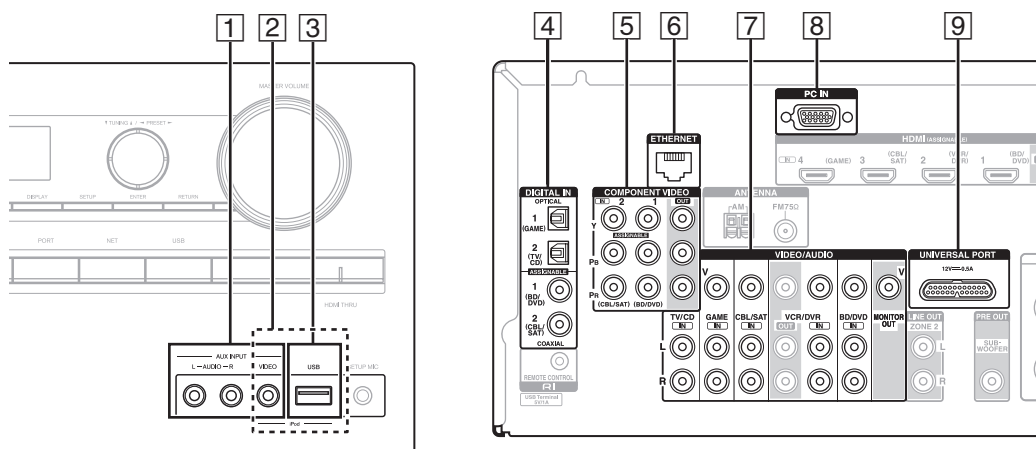

Connect your components to the appropriate jacks. The default input assignments are shown below. See “Connection Tips and Video Signal Path” for more information (→ [page 76](#)).

✓: Assignment can be changed (→ [page 41](#)).

No.	Jack/Port	Components	Assignable	
1	AUX INPUT AUDIO L/R VIDEO	Camcorder, etc		
2	USB, AUX INPUT VIDEO*1	iPod/iPhone (video playback)		
3	USB*2	iPod/iPhone, MP3 player, USB flash drive		
4	DIGITAL IN OPTICAL COAXIAL	1 (GAME)	Game console	✓
		2 (TV/CD)	TV, CD player	✓
		1 (BD/DVD)	Blu-ray Disc/DVD player	✓
		2 (CBL/SAT)	Satellite/cable set-top box, RI dock, etc.	✓
5	COMPONENT VIDEO IN 1 (BD/DVD) IN 2 (CBL/SAT) OUT	Blu-ray Disc/DVD player, RI dock	✓	
		Satellite/cable set-top box, RI dock, etc.	✓	
		TV, projector, etc.		
6	ETHERNET	Router		
7	MONITOR OUT	TV, projector, etc.		
	BD/DVD IN	Blu-ray Disc/DVD player		
	VCR/DVR IN	VCR or DVD recorder/digital video recorder, RI dock		
	CBL/SAT IN	Satellite/cable set-top box, etc.		
	GAME IN	Game console, RI dock		
	TV/CD IN	TV, CD player, cassette tape deck, MD, CD-R, Turntable*3, RI dock		
8	PC IN*4	Personal computer	✓	
9	UNIVERSAL PORT	Universal port option dock (UP-A1 etc.)		

Note

- *1 When **USB** input is selected, you can input video signals from the **AUX INPUT VIDEO** jack. Video signals input from **AUX INPUT VIDEO** will be output from the **MONITOR OUT V** jack.
- *2 Do not connect the AV receiver's **USB** port to a USB port on your computer. Music on your computer cannot be played through the AV receiver in this way.
- *3 Connect a turntable (MM) that has a phono preamp built-in. If your turntable (MM) doesn't have it, you'll need a commercially available phono preamp.
If your turntable has a moving coil (MC) type cartridge, you'll need a commercially available MC head amp or MC transformer as well as a phono preamp. See your turntable's manual for details.

- *4 When you connect your personal computer to **PC IN** and select the corresponding input selector, the video of the personal computer is output from the HDMI outputs. However, if you have assigned the HDMI inputs to the same input selector, the AV receiver will output signals received from the HDMI inputs instead of signals from **PC IN**. To have the signals output from **PC IN**, select “- - - -” for the corresponding input selector in the “**HDMI Input**” setting (→ **page 40**).
- With connection [4], you can enjoy Dolby Digital and DTS. (To record or listen the audio in Zone 2 as well, use [4] and [7].)
 - With connection [7], you can listen to and record audio from external components while you are in Zone 2.
 - With connection [7], if your Blu-ray Disc/DVD player has both the main stereo and multichannel outputs, be sure to connect to the main stereo.

■ How to record a video source

With the connections described above, you cannot record the videos through the AV receiver. See “Recording” about connections for video recording (→ **page 38**).

Connecting Onkyo RI Components

- 1 Make sure that each Onkyo component is connected with an analog audio cable (connection 7 in the hookup examples) (→ page 16).
- 2 Make the **RI** connection (see the illustration).
- 3 If you're using an RI Dock, or cassette tape deck, change the Input Display (→ page 37).

With **RI** (Remote Interactive), you can use the following special functions:

■ System On/Auto Power On

When you start playback on a component connected via **RI** while the AV receiver is on Standby, the AV receiver will automatically turn on and select that component as the input source.

■ Direct Change

When playback is started on a component connected via **RI**, the AV receiver automatically selects that component as the input source.

■ Remote Control

You can use the AV receiver's remote controller to control your other **RI**-capable Onkyo components, pointing the remote controller at the AV receiver's remote control sensor instead of the component. You must enter the appropriate remote control code first (→ page 62).

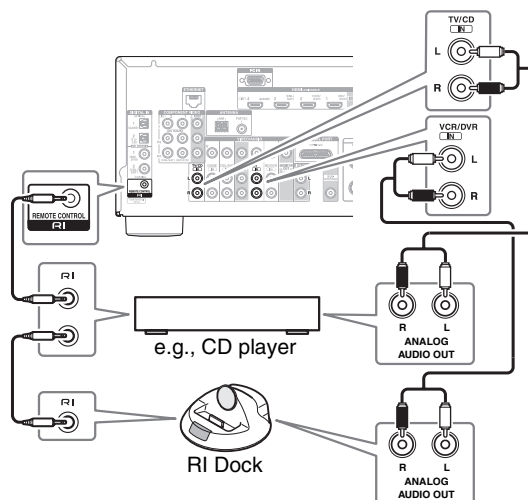

Note

- Use only **RI** cables for **RI** connections. **RI** cables are supplied with Onkyo components.
- Some components have two **RI** jacks. You can connect either one to the AV receiver. The other jack is for connecting additional **RI**-capable components.
- Connect only Onkyo components to **RI** jacks. Connecting other manufacturer's components may cause a malfunction.
- Some components may not support all **RI** functions. Refer to the manuals supplied with your Onkyo components.
- While Zone 2 is on, the System On/Auto Power On and Direct Change **RI** functions do not work.

Connecting a Recording Component

See "Recording" for details on recording (→ page 38).

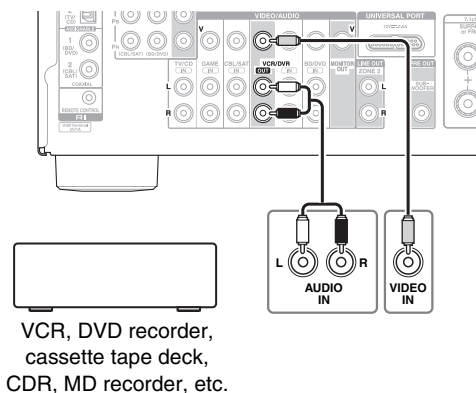

Note

- The AV receiver must be turned on for recording. Recording is not possible while it's in standby mode.
- If you want to record directly from your TV or playback VCR to the recording VCR without going through the AV receiver, connect the TV/VCR's audio and video outputs directly to the recording VCR's audio and video inputs. See the manuals supplied with your TV and VCR for details.
- Video signals connected to composite video inputs can be recorded only via composite video outputs. For example, if your TV/VCR is connected to a composite video input, the recording VCR must be connected to a composite video output.
- The surround sound and DSP listening modes cannot be recorded.
- Copy-protected Blu-ray Discs and DVDs cannot be recorded.
- Sources connected to a digital input cannot be recorded. Only analog inputs can be recorded.
- DTS signals will be recorded as noise, so don't attempt analog recording of DTS CDs or LDs.

Connecting the Antennas

This section explains how to connect the supplied indoor FM antenna and AM loop antenna.

The AV receiver won't pick up any radio signals without any antenna connected, so you must connect the antenna to use the tuner.

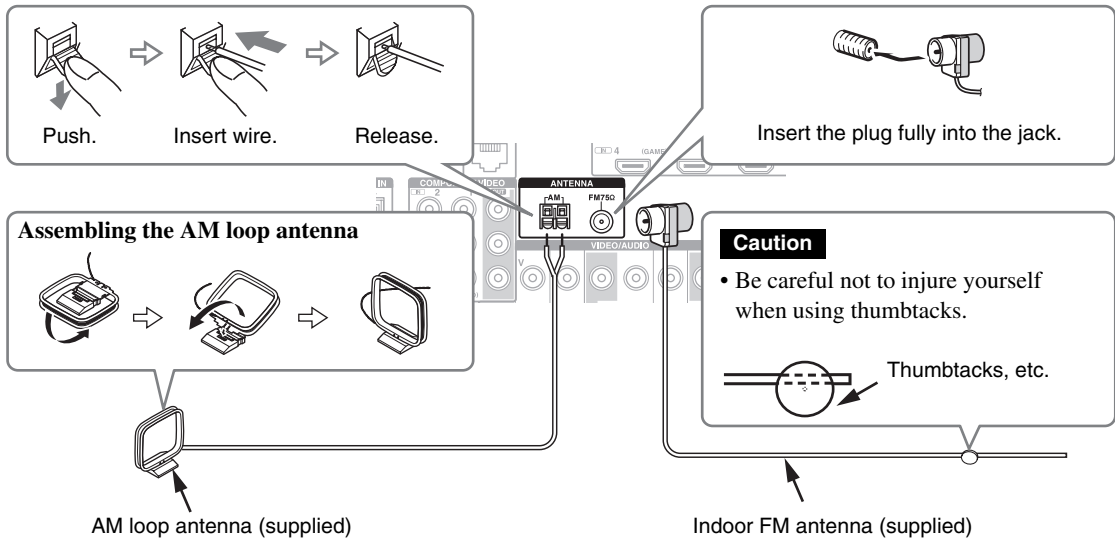

Note

- Once your AV receiver is ready for use, you'll need to tune into a radio station and position the antenna to achieve the best possible reception.
- Keep the AM loop antenna as far away as possible from your AV receiver, TV, speaker cables, and power cords.

Tip

- If you cannot achieve good reception with the supplied indoor FM antenna, try a commercially available outdoor FM antenna instead.
- If you cannot achieve good reception with the supplied indoor AM loop antenna, try using it with a commercially available outdoor AM antenna.

Connecting the Power Cord

1 Plug the power cord into an AC wall outlet.

Note

- **Before connecting the power cord, connect all of your speakers and AV components.**
- Turning on the AV receiver may cause a momentary power surge that might interfere with other electrical equipment on the same circuit. If this is a problem, plug the AV receiver into a different branch circuit.

Turning On/Off the AV Receiver

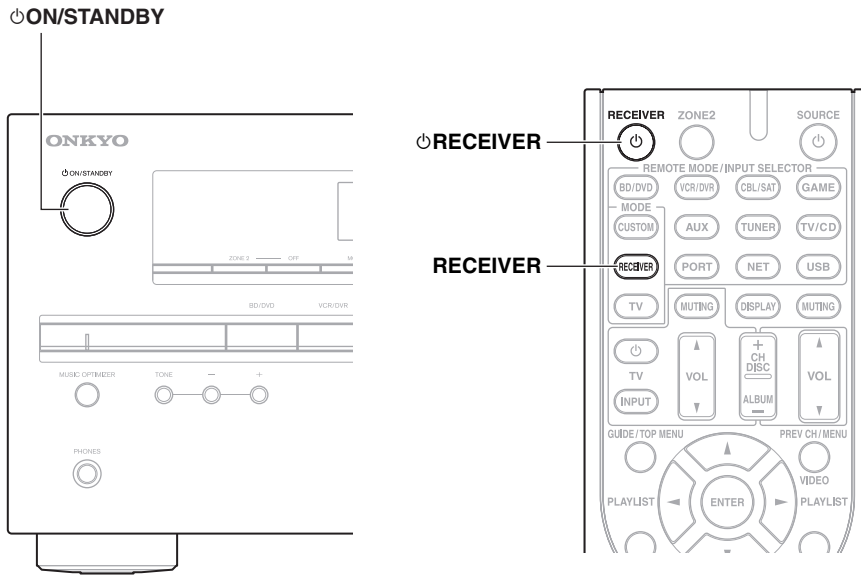

Turning On

1 Press **ON/STANDBY** on the front panel.

or

Press **RECEIVER** followed by **RECEIVER** on the remote controller.

The AV receiver comes on, the display lights.

Turning Off

1 Press **ON/STANDBY** on the front panel.

or

Press **RECEIVER** followed by **RECEIVER** on the remote controller.

The AV receiver will enter standby mode. To prevent any loud surprises when you turn on the AV receiver, always turn down the volume before you turn it off.

Tip

- For details on power management settings, see “Auto Standby” (→ [page 52](#)).

Playback

The on-screen menus appear only on a TV that is connected to the **HDMI OUT**. If your TV is connected to other video outputs, use the AV receiver's display when changing settings.

This section describes the procedure for using the remote controller unless otherwise specified.

Selecting the Language for the Onscreen Setup Menus

You can determine the language used for the onscreen setup menus. See "Language" in the "OSD Setup" (→ page 50).

Playing the Connected Component

■ Operating with the remote controller

- 1** Press **RECEIVER** followed by **INPUT SELECTOR**.
- 2** Start playback on the source component.
See also:
 - "Playing an iPod/iPhone via USB" (→ page 22)
 - "Playing a USB Device" (→ page 23)
 - "Listening to Internet Radio" (→ page 23)
 - "Playing Music Files on a Server" (→ page 25)
 - "Remote Playback" (→ page 25)
 - "Listening to AM/FM Radio" (→ page 26)
 - "iPod/iPhone Playback via Onkyo Dock" (→ page 58)
 - "Controlling Other Components" (→ page 61)
- 3** To adjust the volume, use **VOL ▲/▼**.
- 4** Select a listening mode and enjoy!
See also:
 - "Using the Listening Modes" (→ page 31)
 - "Audyssey" (→ page 45)

■ Operating on the AV receiver

- 1** Use the input selector buttons to select the input source.
- 2** Start playback on the source component.
- 3** To adjust the volume, use the **MASTER VOLUME** control.
- 4** Select a listening mode and enjoy!

Controlling Contents of USB or Network Devices

See "Controlling Other Components" about the operation of other components (→ page 61).

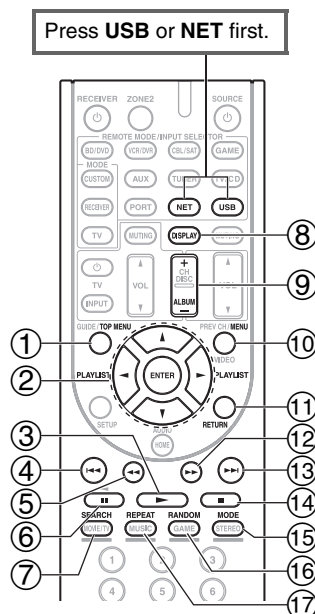

①	TOP MENU This button displays the top menu for each media or service.
②	▲/▼ and ENTER These buttons navigate through the menus. ◀/▶ This button cycles through pages. PLAYLIST ◀/▶ In Standard Mode (iPod/iPhone), this button selects playlists.
③	▶ This button starts playback.
④	◀◀ This button selects the beginning of the current song. Pressing this button twice selects the previous song.
⑤	◀ This button fast-reverses the current song.
⑥	 This button pauses playback.
⑦	SEARCH You can toggle between the playback screen and the list screen during playback.
⑧	DISPLAY This button switches between song informations.
⑨	ALBUM +/- In Standard Mode (iPod/iPhone), this button selects albums.













10	MENU This button returns to top menu of the Internet Radio service.
11	RETURN This button returns to the previous menu.
12	▶▶ This button fast-forwards the current song.
13	▶▶▶ This button selects the next song.
14	■ This button stops playback.
15	MODE You can switch between Standard Mode and Extended Mode during iPod/iPhone playback.
16	RANDOM This button performs random playback.
17	REPEAT Press this button repeatedly to cycle through the repeat modes.

Note

- The buttons you can use will differ depending on the devices and media used for playback.

Understanding Icons on the Display

This section describes icons that appear on the display during media playback.

Displayed Icons	
Icon	Description
	Folder
	Track
	Playback
	Pause
	Fast Forward
	Fast Reverse
	Artist
	Album
	Repeat One Track
	Repeat Folder (USB Device)
	Repeat
	Shuffle
	Shuffle Album (iPod/iPhone)

Playing an iPod/iPhone via USB

This section explains how to play music/video files on the iPod/iPhone.

Compatible iPod/iPhone models

Made for:

iPod touch (1st, 2nd, 3rd and 4th generation), iPod classic, iPod with video, iPod nano (1st, 2nd, 3rd, 4th, 5th and 6th generation), iPhone 4, iPhone 3GS, iPhone 3G, iPhone

- 1 Press **USB** to select the “USB” input.
- 2 Connect the USB cable that comes with the iPod/iPhone to the USB port on the front of the AV receiver.
While reading the contents of your iPod/iPhone, the message “**Connecting...**” appears on the display. The USB indicator lights. It will flash if the AV receiver cannot read the iPod/iPhone.
- 3 Press **MODE** repeatedly to switch to **Extended Mode (Music)** or **Extended Mode (Video)**.
A list of your iPod/iPhone model’s contents appears. To open a folder, use **▲/▼** to select it, and then press **ENTER**.

Tip

- With the default settings, the iPod/iPhone is operated in Standard Mode.
- Pressing **MODE** repeatedly switches back to Standard Mode.
- When you disconnect the iPod/iPhone, the AV receiver stores the mode. This means that if you disconnect when in Extended Mode (Music), the AV receiver will start in Extended Mode (Music) the next time you connect the iPod/iPhone.
- You can also use **▲/▼**, **ENTER** and **TUNING MODE** buttons on the front panel. **TUNING MODE** allows you to switch modes.
- When connecting your iPod/iPhone with a USB cable, we recommend you use an official USB cable from Apple Inc.

- 4 Use **▲/▼** to select a music/video file, and press **ENTER** or **▶** to start playback.

Note

- Do not disconnect the USB device or USB cable that comes with iPod/iPhone to the **USB** port at the front of the AV receiver, while the message “**Connecting...**” appears on the display.
- If you connect an iPod or iPhone to the **USB** port on this device, no sound will be output from the headphones jack.

Extended Mode (Music) control

The music content information is displayed (lists are displayed), and you can control the music content while looking at the screen.

Top screen list:

Playlists, Artists, Albums, Genres, Songs, Composers, Shuffle Songs, Now Playing.

Extended Mode (Video) control

The video content information is displayed (lists are displayed), and you can control the video content while looking at the screen.

Top screen list:

Movies, Music Videos, TV Shows, Video Podcasts, Rentals.

Note

- To view the video contents of your iPod/iPhone, connect it to the **USB** port and **AUX INPUT VIDEO** jack on the AV receiver's front panel, using the official Apple Composite AV Cable.
- Depending on your iPod/iPhone model and generation, the displayed items may vary and the support for Extended Mode (Video) is not guaranteed.

Standard Mode control

The content information is not displayed, but can be operated using the iPod/iPhone or the remote controller (**USB**).

Note

- The following iPod models are not supported in Standard Mode. (They can only be controlled in Extended Mode.)
 - iPod with video
 - iPod nano (1st generation)

Playing a USB Device

This section explains how to play music files from a USB device (e.g., USB flash drives and MP3 players).

See also:

- “Network/USB Features” (→ **page 70**).

- 1 Press **USB** to select the “USB” input.**
- 2 Plug your USB device into the AV receiver’s USB port.**

The **USB** indicator lights. It will flash if the AV receiver cannot read the USB device.
- 3 Press **ENTER**.**

A list of the device’s contents appears. To open a folder, use **▲/▼** to select it, and then press **ENTER**.
- 4 Use **▲/▼** to select a music file, and press **ENTER** or **▶** to start playback.**

Note

- Do not disconnect the USB device or USB cable that comes with iPod/iPhone to the **USB** port at the front of the AV receiver, while the message “Connecting...” appears on the display.

Listening to Internet Radio

You need to connect the AV receiver to your home network (→ **page 70**).

You can select Internet radio stations by connecting to the AV receiver from your computer and selecting stations in your web browser.

Internet radio URLs in the following formats are supported: PLS, M3U, and podcast (RSS). However, depending on the type of data or audio format used by the Internet radio station, you may not be able to listen to some stations.

Note

- Services available may vary depending on the region. See the separate instructions for more information.

Listening to vTuner Internet Radio

This unit includes the full vTuner Internet Radio Service at no additional charge. Once you have connected your unit to the Internet you can select vTuner Internet Radio to search for and play Internet radio stations and podcasts at any time. To enhance your Internet radio experience, the <http://onkyo.vtuner.com/> portal is available to you as an easy way to browse to find stations, set up/organize your favorites, add your own stations, get help, etc. After the first time you try vTuner Internet Radio on your unit you can use the MAC Address of your unit to create a member login account (email address and password) on the <http://onkyo.vtuner.com/> portal. To verify your MAC Address, please see “Network” (→ **page 53**).

- 1 Press **NET**.**

The “NET” screen appears, and the **NET** indicator lights. If it flashes, verify that the Ethernet cable is firmly connected to the AV receiver.
- 2 Use **▲/▼/◀/▶** to select “vTuner Internet Radio” and then press **ENTER**.**

3 Use ▲/▼ to select a program and then press **ENTER**.

Playback starts.

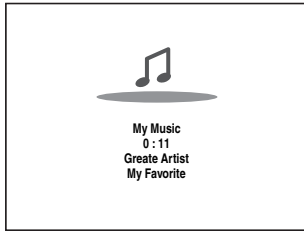

Press **MENU** to enable selection from the following menu items.

▶ **Stations like this:**

Stations like the one currently being played back are displayed.

▶ **Add to My Favorites:**

Adds a station to My Favorites list.

Press **TOP MENU** to go to the top menu of the Internet Radio services.

Tip

- By pressing **SEARCH**, you can toggle between the playback screen and the radio list screen.

Listening to Other Internet Radio

To listen to other internet radio stations, insert the following step after step 1 in the “Listening to vTuner Internet Radio” section.

1 On your computer, start your web browser and enter the AV receiver’s IP address in the browser’s Internet address (URL) field.

The browser connects to the AV receiver (WEB Setup Menu).

Note

- The AV receiver’s IP address is shown on “IP Address” (→ page 53).
- If you’re using DHCP, your router may not always allocate the same IP address to the AV receiver, so if you find that you can’t connect to the AV receiver, recheck the AV receiver’s IP address on the “Network” screen.

2 Click on the “My Favorites” tab.

3 Enter the preset name and Internet address (URL).

4 Click “Save” to save the Internet radio station.

5 The Internet radio station is then added to “My Favorites”.

Registering My Favorites*1

You can add the currently playing song or station to the “My Favorites”. You can save up to 40 Internet radio stations.

Once you’ve added a station to the list, simply select it in the “My Favorites” menu, and then press **ENTER** to start playback.

- *1 From the search results you can save the stations and songs but cannot listen to them directly.

■ **Top menu of Internet Radio**

▶ **Create new station:**

Add a favorite station or Internet radio to the My Favorites.

▶ **Rename this station:**

You can rename the stations and songs saved in “My Favorites” list.

▶ **Delete from My Favorites:**

You can delete the stations and songs saved in “My Favorites” list.

1 Press **MENU** with the station selected or while a song is playing.

2 Use ▲/▼ to select “Add to My Favorites”, and press **ENTER**.

3 Use ▲/▼/◀/▶ to select “OK”, and then press **ENTER**.

Tip

- If you choose to rename the station, see “Name Edit” (→ page 47).

Playing Music Files on a Server

You need to connect the AV receiver to your home network (→ [page 70](#)).

This section explains how to play music files on a computer or media server through the AV receiver (Server Playback).

- 1 Start your computer or media server.
- 2 Press **NET**.
The “NET” screen appears. The NET indicator lights. If it flashes, confirm the network connection.
- 3 Use **▲/▼/◀/▶** to select “dlna”, and press **ENTER**.
Tip
 - To go back to the previous screen, press **RETURN**.
- 4 Use **▲/▼** to select a server, and then press **ENTER**.
The menu is displayed according to the server functions.
Note
 - The search function does not work with media servers which do not support this function.
 - Photos and movies stored on a media server cannot be accessed from the AV receiver.
 - Depending on the sharing settings in the media server, the AV receiver may not be able to access the content. See the instruction manual of the media server.
- 5 Use **▲/▼** to select an item, and then press **ENTER** or **▶** to start playback.

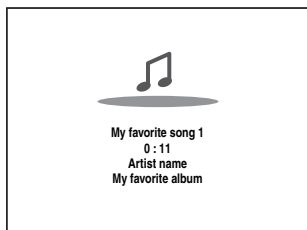

Note

- Depending on the media server, **◀◀/▶▶/||** may not work.
- If the message “No Item.” appears, this means that no information can be retrieved from the server. In this case, check your server, network, and AV receiver connections.

Windows Media Player 11 Setup

This section explains how to configure Windows Media Player 11 so that the AV receiver can play the music files stored on your computer.

- 1 Start Windows Media Player 11.
- 2 On the “Library” menu, select “Media Sharing”.
The “Media Sharing” dialog box appears.
- 3 Select the “Share my media” check box, and then click “OK”.
- 4 Select the AV receiver in the list, and then click “Allow”.
- 5 Click “OK” to close the dialog box.
This completes the Windows Media Player 11 configuration.
You can now play the music files in your Windows Media Player 11 library through the AV receiver.
Tip
 - Windows Media Player 11 can be downloaded for free from the Microsoft web site.

Remote Playback

You need to connect the AV receiver to your home network (→ [page 70](#)).

Remote Playback means you can play the music files stored on a media server or personal computer with the AV receiver by operating the controller device in the home network.

Windows Media Player 12 Setup

This section explains how to configure Windows Media Player 12 so that the AV receiver can play the music files stored on your personal computer.

- 1 Start Windows Media Player 12.
- 2 On the “Stream” menu, select “Turn on media streaming”.
A dialog box appears.
- 3 Move your cursor and click on “Turn on media streaming”.
A list of media server appears. Wording may vary slightly depending on the network location.
- 4 Select the product in the list, and then click “Allowed”.
- 5 Click “OK” to close the dialog box.
This completes the Windows Media Player 12 configuration.
You can now play the music files in your Windows Media Player 12 library.

1 Start Windows Media Player 12.

To enable remote playback, you must first configure Windows Media Player 12.

2 Press NET.

The “NET” screen appears. The NET indicator lights. If it flashes, verify the network connection.

3 Use ▲/▼/◀/▶ to select “dlna”, and press ENTER.

A list of media server appears.

Note

- Remote playback cannot be used while the music files of another media server are being played. You must stop their playback first.

4 On Windows Media Player 12, right-click on a music file.

The right-click menu appears. For selecting another media server, select the desired media server from the “Other Libraries” menu on Windows Media Player 12.

5 Select the AV receiver from the right-click menu.

The “Play to” window appears and playback on the product starts. Operations during remote playback can be made from the “Play to” window of Windows 7 on your personal computer. During remote playback, operations (such as Playback, Pause, Fast Forward, Fast Rewind, Previous, Next, Repeat, Random) cannot be made.

6 Adjusting the Volume

You can adjust the volume by adjusting the volume bar in the “Remote playback” window. The default maximum volume level is 82 (0dB). If you wish to change this, enter the value from the Web Setup in your browser.

The volume value of the remote window and the volume value of the AV receiver may not always match.

Adjustments you make to the volume in the AV receiver will not be reflected in the “Remote playback” window.

This section describes the procedure using the buttons on the front panel unless otherwise specified.

Using the Tuner

With the built-in tuner you can enjoy AM and FM radio stations. You can store your favorite stations as presets for quick selection.

You can also change the frequency steps (→ page 51).

1 Press TUNER to select either “AM” or “FM”.

In this example, FM has been selected.

Each time you press TUNER, the radio band changes between AM and FM.

Band	Frequency
FM	87.5 MHz

(Actual display depends on the country.)

Tuning into Radio Stations

■ Auto tuning mode

1 Press TUNING MODE so that the AUTO indicator lights on the display.

2 Press TUNING ▲/▼.

Searching stops when a station is found.

When tuned into a station, the TUNED indicator lights. When tuned into a stereo FM station, the FM STEREO indicator lights on the display, as shown.

Band	Frequency	Indicators
FM	87.5 MHz	TUNED, AUTO, FM STEREO

Tip

• Tuning into weak FM stereo stations

If the signal from a stereo FM station is weak, it may be impossible to get good reception. In this case, switch to manual tuning mode and listen to the station in mono.

■ Manual tuning mode

In manual tuning mode, FM stations will be in mono.

1 Press TUNING MODE so that the AUTO indicator goes off on the display.

2 Press and hold TUNING ▲/▼.

The frequency stops changing when you release the button.

Press the buttons repeatedly to change the frequency one step at a time.

■ Tuning into stations by frequency

You can tune into AM and FM stations directly by entering the appropriate frequency.

- 1 On the remote controller, press **TUNER** repeatedly to select “AM” or “FM”, followed by **D.TUN.**

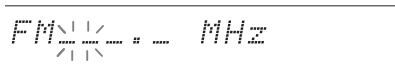

(Actual display depends on the country.)

- 2 Within 8 seconds, use the number buttons to enter the frequency of the radio station.

For example, to tune to 87.5 (FM), press **8, 7, 5**.

If you have entered the wrong number, you can retry after 8 seconds.

Presetting AM/FM Stations

You can store a combination of up to 40 of your favorite AM/FM radio stations as presets.

- 1 Tune into the AM/FM station that you want to store as a preset.

See the previous section.

- 2 Press **MEMORY**.

The preset number flashes.

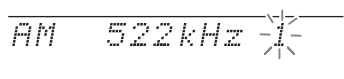

(Actual display depends on the country.)

- 3 While the preset number is flashing (about 8 seconds), use **PRESET** ◀/▶ to select a preset from 1 through 40.

- 4 Press **MEMORY** again to store the station or channel.

The station or channel is stored and the preset number stops flashing.

Repeat this procedure for all of your favorite AM/FM radio stations.

Note

- You can name your radio presets for easy identification (→ **page 47**). Its name is displayed instead of the band and frequency.

■ Selecting Presets

- 1 To select a preset, use **PRESET** ◀/▶ on the AV receiver, or the remote controller's **CH +/-**.

Tip

- You can also use the remote controller's number buttons to select a preset directly.

■ Deleting Presets

- 1 Select the preset that you want to delete.

See the previous section.

- 2 While holding down **MEMORY**, press **TUNING MODE**.

The preset is deleted and its number disappears from the display.

Using Basic Functions

Using the Automatic Speaker Setup

With the supplied calibrated microphone, Audyssey 2EQ® automatically determines the number of speakers connected, their size for purposes of bass management, optimum crossover frequencies to the subwoofer (if present), and distances from the primary listening position.

Audyssey 2EQ then removes the distortion caused by room acoustics by capturing room acoustical problems over the listening area in both the frequency and time domain. The result is clear, well-balanced sound for everyone. Audyssey 2EQ can be used with

Audyssey Dynamic EQ® and Audyssey Dynamic Volume® (→ **pages 45, 46**).

Before using this function, connect and position all of your speakers.

Audyssey 2EQ offers two ways of measuring: the “Audyssey Quick Start” and “Audyssey 2EQ Full Calibration”.

- “Audyssey Quick Start” uses the measurement from one position to perform the speaker setting only.
- “Audyssey 2EQ Full Calibration” uses the measurement from three positions to correct room response in addition to the speaker setting.

The Quick Start takes 2 minutes and Full Calibration takes about 10 minutes.

Total measurement time varies depending on the number of speakers.

Measurement procedure

To create a listening environment in your home theater that all listeners will enjoy, Audyssey 2EQ takes measurements at up to three positions within the listening area. Position the microphone at ear height of a seated listener with the microphone tip pointed directly at the ceiling using a tripod. Do not hold the microphone in your hand during measurements as this will produce inaccurate results.

① First measurement position

Also referred to as the Main Listening Position this refers to the most central position where one would normally sit within the listening environment.

Audyssey 2EQ uses the measurements from this position to calculate speaker distance, level, polarity, and the optimum crossover value for the subwoofer.

② Second measurement position

The right side of the listening area.

③ Third measurement position

The left side of the listening area.

The distances from position ① to ② and ① to ③ must be at least 1 meter.

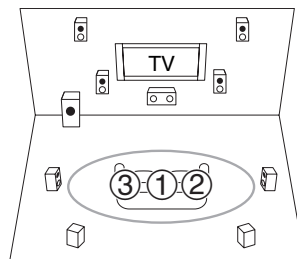

○ : Listening area ① to ③: Listening position

Note

- Make the room as quiet as possible. Background noise and Radio Frequency Interference (RFI) can disrupt the room measurements. Close windows, televisions, radios, air conditioners, fluorescent lights, home appliances, light dimmers, or other devices. Turn off the cell phone (even if it is not in use) or place it away from all audio electronics.
- The microphone picks up test tones played through each speaker as Audyssey 2EQ Room Correction and Speaker Setup run.
- Audyssey 2EQ Room Correction and Speaker Setup cannot be performed while a pair of headphones is connected.

1 Turn on the AV receiver and the connected TV.

On the TV, select the input to which the AV receiver is connected.

2 Set the speaker setup microphone at the Main Listening Position ①, and connect it to the SETUP MIC jack.

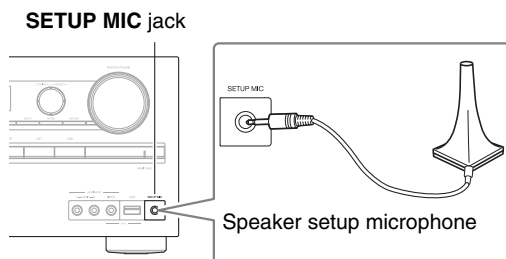

The speaker setting menu appears.

Note

- The on-screen menus appear only on a TV that is connected to the **HDMI OUT**. If your TV is connected to other video outputs, use the AV receiver's display when changing settings.

3 When you've finished making the settings, press **ENTER**.

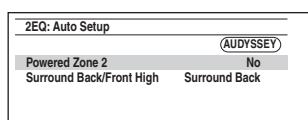

Perform the "Speaker Setup" according to your speaker configuration:

- **Powered Zone 2** (→ **page 42**)
- **Surround Back/Front High** (→ **page 42**)

When an optional unit is connected to the **UNIVERSAL PORT** jack on the AV receiver, the optional unit setting may appear on the speaker setting menu.

4 Use ▲/▼ to select "Audyssey Quick Start" or "Audyssey 2EQ Full Calibration".

5 Press **ENTER**.

Audyssey 2EQ® Room Correction and Speaker Setup starts.

Test tones are played through each speaker as Audyssey 2EQ Room Correction and Speaker Setup runs. This process takes a few minutes. Please **refrain from talking** during measurements and **do not stand** between speakers and the microphone.

Do not disconnect the speaker setup microphone during Audyssey 2EQ Room Correction and Speaker Setup, unless you want to cancel the setup.

If you select "Audyssey Quick Start", you will go to step 8.

6 Place the setup microphone at the next position, and then press **ENTER**.

Audyssey 2EQ performs more measurements. This takes a few minutes.

7 When prompted, repeat step 6.

8 Use ▲/▼ to select an option, and then press **ENTER**.

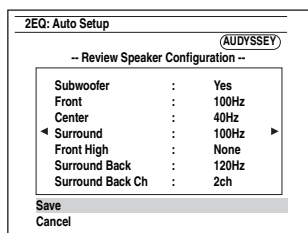

The options are:

▶ **Save:**

Save the calculated settings and exit Audyssey 2EQ Room Correction and Speaker Setup.

▶ **Cancel:**

Cancel Audyssey 2EQ Room Correction and Speaker Setup.

Tip

- You can view the calculated settings for the speaker configuration, speaker distances, and speaker levels by using ◀/▶.

9 Use ▲/▼ to select a target, and use ◀/▶ to change the setting.

After the results of Audyssey 2EQ have been saved, the menu will display the "Audyssey" (→ **page 45**), "Dynamic EQ" (→ **page 45**), "Dynamic Volume" (→ **page 46**) settings.

Note

- When "Audyssey Quick Start" has been used for measurement, "Audyssey" cannot be selected.
- These settings are applied to all input selectors.

10 Press **ENTER**.

11 Disconnect the speaker setup microphone.

Note

- You can cancel Audyssey 2EQ Room Correction and Speaker Setup at any point in this procedure simply by disconnecting the setup microphone.
- Do not connect or disconnect any speakers during Audyssey 2EQ Room Correction and Speaker Setup.
- If the AV receiver is muted, it will be unmuted automatically when Audyssey 2EQ Room Correction and Speaker Setup starts.
- Changes to the room after Audyssey 2EQ Room Correction and Speaker Setup requires you run Audyssey 2EQ Room Correction and Speaker Setup again, as room EQ characteristics may have changed.

Error Messages

While Audyssey 2EQ® Room Correction and Speaker Setup is in progress, one of the error messages below may appear.

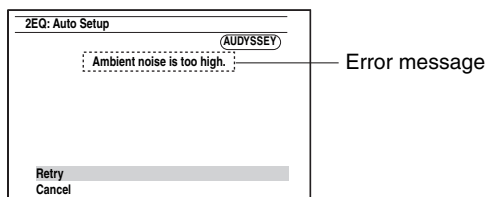

The options are:

- ▶ **Retry:**
Try again.
- ▶ **Cancel:**
Cancel Audyssey 2EQ Room Correction and Speaker Setup.
- **Ambient noise is too high.**
The background noise is too loud. Remove the source of the noise and try again.
- **Speaker Matching Error!**
The number of speakers detected was different from that of the first measurement. Check the speaker connection.
- **Writing Error!**
This message appears if saving fails. Try saving again. If this message appears after 2 or 3 attempts, contact your Onkyo dealer.
- **Speaker Detect Error**
This message appears if a speaker is not detected. “No” means that no speaker was detected.

Tip

- See “Speaker Configuration” for appropriate settings (→ **page 12**).

Changing the Speaker Setup Manually

You can manually make changes to the settings found during Audyssey 2EQ Room Correction and Speaker Setup.

See also:

- “Speaker Configuration” (→ **page 42**)
- “Speaker Distance” (→ **page 43**)
- “Level Calibration” (→ **page 43**)

Using a Powered Subwoofer

If you’re using a powered subwoofer and it outputs very low-frequency sound at a low volume level, it may not be detected by Audyssey 2EQ Room Correction and Speaker Setup.

If the “**Subwoofer**” appears on the “**Review Speaker Configuration**” screen as “**No**”, increase the subwoofer’s volume to the half-way point, set it to its highest crossover frequency, and then try running Audyssey 2EQ Room Correction and Speaker Setup again. Note that if the volume is set too high and the sound distorts, detection issues may occur, so use an appropriate volume level. If the subwoofer has a low-pass filter switch, set it to Off or Direct. Refer to your subwoofer’s instruction manual for details.

Selecting Listening Modes

See “About Listening Modes” for detailed information about the listening modes (→ page 32).

■ Listening Mode Buttons

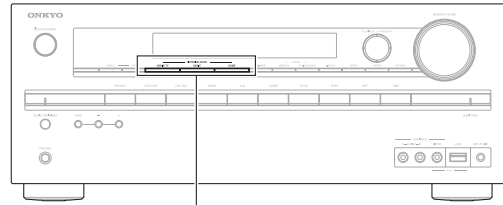
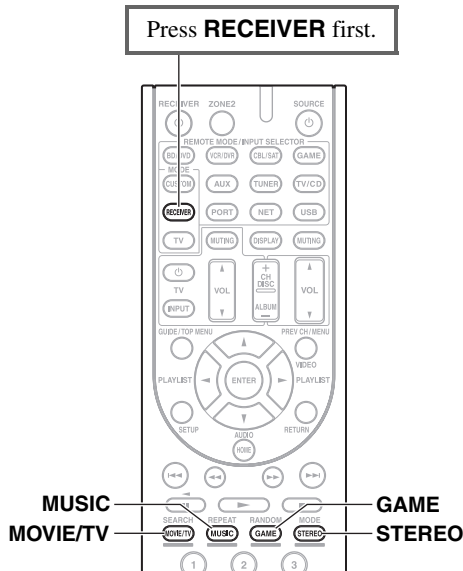

MOVIE/TV button

This button selects the listening modes intended for use with movies and TV.

MUSIC button

This button selects the listening modes intended for use with music.

GAME button

This button selects the listening modes intended for use with video games.

STEREO button

This button selects the Stereo listening mode and All Channel Stereo listening mode.

- The Dolby Digital and DTS listening modes can only be selected if your Blu-ray Disc/DVD player is connected to the AV receiver with a digital audio connection (coaxial, optical, or HDMI).
- The listening modes you can select depends on the format of the input signal. To check the format, see “Displaying Source Information” (→ page 37).
- While a pair of headphones is connected, you can select the following listening modes: Mono, Direct, and Stereo.

About Listening Modes

The AV receiver's listening modes can transform your listening room into a movie theater or concert hall, with high fidelity and stunning surround sound.

■ Explanatory Notes

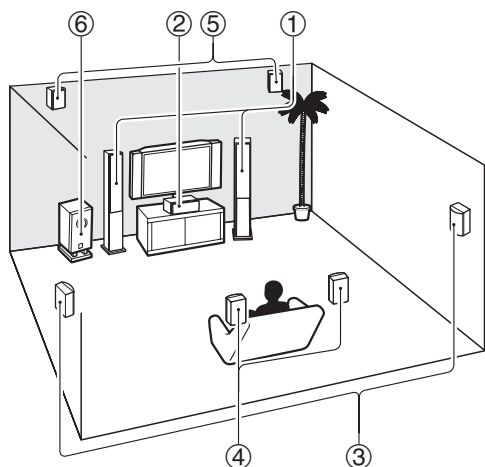

- ① Front speakers
- ② Center speaker
- ③ Surround speakers
- ④ Surround back speakers
- ⑤ Front high speakers
- ⑥ Subwoofer

Input Source

The following audio formats are supported by the listening mode.

MONO	This is mono (monophonic) sound.
STEREO	This is stereo (stereophonic) sound. Two independent audio signal channels are reproduced through two speakers.
5.1ch	This is 5.1-channel surround sound. This surround system has five main channels of sound and a sixth subwoofer channel (called the point-one channel).
7.1ch	This is 7.1-channel surround sound. This is a further sound enhancement to 5.1 channel sound with two additional speakers that provide greater sound envelopment and more accurate positioning of sounds.
DTS-ES	This is DTS-ES surround sound. This surround system can produce a discrete or a matrix-encoded sixth channel from existing DTS 5.1 encoded material.
DDEX	This is Dolby Digital EX surround sound. This provides a center back surround channel from 5.1-channel sources.

Speaker Layout

The illustration shows which speakers are activated in each channel. See "Speaker Configuration" for the speaker setup (→ page 42).

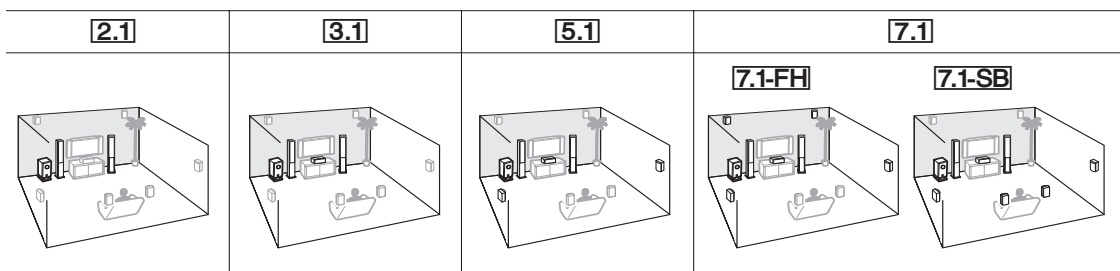

■ Onkyo-Original DSP Listening Modes

Listening Mode	Description	Input Source	Speaker Layout	
Orchestra <i>Orchestra</i>	Suitable for classical or operatic music, this mode emphasizes the surround channels in order to widen the stereo image, and simulates the natural reverberation of a large hall.	MONO STEREO 5.1ch 7.1ch DTS-ES DDEX	5.1 7.1	
Unplugged <i>Unplugged</i>	Suitable for acoustic instruments, vocals, and jazz, this mode emphasizes the front stereo image, giving the impression of being right in front of the stage.			
Studio-Mix <i>Studio-Mix</i>	Suitable for rock or pop music, listening to music in this mode creates a lively sound field with a powerful acoustic image, like being at a club or rock concert.			
TV Logic <i>TV Logic</i>	This mode adds realistic acoustics to TV shows produced in a TV studio, surround effects to the entire sound, and clarity to voices.			
Game-RPG <i>Game-RPG</i>	In this mode, the sound has a dramatic feel with a similar atmosphere to Orchestra mode.			
Game-Action <i>Game-Action</i>	In this mode, sound localization is distinct with emphasis on bass.			
Game-Rock <i>Game-Rock</i>	In this mode, sound pressure is emphasized to heighten live feel.			
Game-Sports <i>Game-Sports</i>	In this mode, reverberation is increased and sound localization decreased slightly.			
All Ch Stereo <i>All Ch Stereo</i>	Ideal for background music, this mode fills the entire listening area with stereo sound from the front, surround, and surround back speakers.			3.1 5.1 7.1
Full Mono <i>Full Mono</i>	In this mode, all speakers output the same sound in mono, so the sound you hear is the same regardless of where you are within the listening room.			
T-D (Theater-Dimensional) <i>T-D</i>	With this mode you can enjoy a virtual surround sound even with only two or three speakers. This works by controlling how sounds reach the listener's left and right ears. Good results may not be possible if there's too much reverb, so we recommend that you use this mode in an environment with little or no natural reverb.	2.1 3.1 5.1 7.1		

■ Listening Modes

Listening Mode	Description	Input Source	Speaker Layout
Direct <i>Direct</i>	In this mode, audio from the input source is output without surround-sound processing. The speaker configuration (presence of speakers) and speaker distance settings are enabled, but much of the processing set via Home menu is disabled. A/V Sync does not have effect on the analog audio. See "Advanced Setup" for more details (→ page 39).	MONO STEREO 5.1ch 7.1ch DTS-ES DDEX	2.1 3.1 5.1 7.1 *1
Stereo <i>Stereo</i>	Sound is output from the front left and right speakers and subwoofer.		
Mono <i>Mono</i>	Use this mode when watching an old movie with a mono soundtrack, or use it with the foreign language soundtracks recorded in the left and right channels of some movies. It can also be used with DVDs or other sources containing multiplexed audio, such as karaoke DVDs.		
Multichannel <i>Multich</i>	This mode is for use with PCM multichannel sources.	5.1ch 7.1ch	3.1 5.1 7.1

Listening Mode	Description	Input Source	Speaker Layout
Dolby Pro Logic IIx² Dolby Pro Logic II	Dolby Pro Logic IIx expands any 2-channel source for 7.1-channel playback. It provides a very natural and seamless surround-sound experience that fully envelops the listener. As well as music and movies, video games can also benefit from the dramatic spatial effects and vivid imaging.		
<i>PLII Movie</i>			
<i>PLII Music</i>	If you're not using any surround back speakers, Dolby Pro Logic II will be used instead of Dolby Pro Logic IIx.	STEREO	3.1 5.1 7.1
<i>PLII Game</i>	<ul style="list-style-type: none"> • Dolby PLIIx Movie Use this mode with any stereo or Dolby Surround (Pro Logic) movie (e.g., TV, DVD, VHS). 		
<i>PLIIx Movie</i>	<ul style="list-style-type: none"> • Dolby PLIIx Music Use this mode with any stereo or Dolby Surround (Pro Logic) music source (e.g., CD, radio, cassette, TV, VHS, DVD). 		
<i>PLIIx Music</i>	<ul style="list-style-type: none"> • Dolby PLIIx Game Use this mode with video games, especially those that bear the Dolby Pro Logic II logo. 		
<i>PLIIx Game</i>	<ul style="list-style-type: none"> • Dolby PLIIx Movie • Dolby PLIIx Music These modes use the Dolby Pro Logic IIx modes to expand 5.1-channel sources for 7.1-channel playback. 	5.1ch	7.1-SB
Dolby Pro Logic IIz Height	Dolby Pro Logic IIz Height is designed to more effectively use existing program material when height channel speaker outputs are present. Dolby Pro Logic IIz Height can be used to upmix a variety of sources from movies and music, but are particularly well-suited to upmix game content.	STEREO 5.1ch 7.1ch	7.1-FH
<i>PLIIZ Height</i>			
Dolby EX	These modes expand 5.1-channel sources for 6.1/7.1-channel playback. They're especially suited to Dolby EX soundtracks that include a matrix-encoded surround back channel. The additional channel adds an extra dimension and provides an enveloping surround sound experience, perfect for rotating and fly-by sound effects.	5.1ch DDEX	7.1-SB
<i>Dolby EX</i>			
<i>Dolby D EX</i>			
Dolby Digital	In this mode, audio from the input source is output without surround-sound processing. The speaker configuration (presence of speakers), crossover frequency, speaker distance, A/V Sync and much of the processing set via Home menu are enabled. See "Advanced Setup" for more details	5.1ch	3.1 5.1 7.1
<i>Dolby D</i>			
Dolby Digital Plus³	(→ page 39).	5.1ch	3.1 5.1 7.1
<i>Dolby D +</i>		7.1ch	3.1 5.1 7.1 ^{*1}
Dolby TrueHD		5.1ch	3.1 5.1 7.1
<i>Dolby TrueHD</i>		7.1ch	3.1 5.1 7.1 ^{*1}
DTS		5.1ch	3.1 5.1 7.1
<i>DTS</i>			
DTS-HD High Resolution Audio		5.1ch	3.1 5.1 7.1
<i>DTS-HD HR</i>		7.1ch	3.1 5.1 7.1 ^{*1}
DTS-HD Master Audio		5.1ch	3.1 5.1 7.1
<i>DTS-HD MSTR</i>		7.1ch	3.1 5.1 7.1 ^{*1}
DTS Express		5.1ch	3.1 5.1 7.1
<i>DTS Express</i>			
DSD⁴			
<i>DSD</i>			
DTS 96/24	This mode is for use with DTS 96/24 sources. This is high-resolution DTS with a 96 kHz sampling rate and 24-bit resolution, providing superior fidelity. Use it with DVDs that bear the DTS 96/24 logo.	5.1ch	3.1 5.1 7.1
<i>DTS 96/24</i>			
DTS-ES Discrete⁵	This mode is for use with DTS-ES Discrete soundtracks, which use a discrete surround back channel for true 6.1/7.1-channel playback. The seven totally separate audio channels provide better spatial imaging and 360-degree sound localization, perfect for sounds that pan across the surround channels. Use it with DVDs that bear the DTS-ES logo, especially those with a DTS-ES Discrete soundtrack.	DTS-ES	7.1-SB
<i>ES Discrete</i>			
DTS-ES Matrix⁵	This mode is for use with DTS-ES Matrix soundtracks, which use a matrix-encoded back-channel for 6.1/7.1-channel playback. Use it with DVDs that bear the DTS-ES logo, especially those with a DTS-ES Matrix soundtrack.	DTS-ES	7.1-SB
<i>ES Matrix</i>			

Listening Mode	Description	Input Source	Speaker Layout
Neo:6	This mode expands any 2-channel source for up to 7.1-channel playback. It uses seven full-bandwidth channels of matrix decoding for matrix-encoded material, providing a very natural and seamless surround sound experience that fully envelops the listener.		
<i>Neo:6 Cinema</i>	<ul style="list-style-type: none"> • Neo:6 Cinema Use this mode with any stereo movie (e.g., TV, DVD, VHS). • Neo:6 Music Use this mode with any stereo music source (e.g., CD, radio, cassette, TV, VHS, DVD). 	STEREO	3.1 5.1 7.1
<i>Neo:6</i>	<ul style="list-style-type: none"> • Neo:6 This mode uses Neo:6 to expand 5.1-channel sources for 6.1/7.1-channel playback. 	5.1ch	7.1-SB

Note

- *1 When the input source contains the encoded front high channel, the corresponding speakers output the sound.
 - *2 If there are no surround back speakers, Dolby Pro Logic II is used.
 - *3 For the Blu-ray Discs, Dolby Digital is used in a 3.1/5.1-channel speaker system.
 - *4 AV receiver can input the DSD signal from HDMI IN. Setting the output setting on the player side to PCM might obtain a better sound according to the player. In that case, set the output setting on the player side to PCM.
 - *5 If there are no surround back speakers, DTS is used.
- The listening modes cannot be selected with some source formats.

Using the Home Menu

The Home menu provides you quick access to frequently used menus without having to go through the long standard menu. This menu enables you to change settings and view the current information.

The on-screen menus appear only on a TV that is connected to the HDMI OUT. If your TV is connected to other video outputs, use the AV receiver's display when changing settings.

1 Press RECEIVER followed by HOME.

The Home menu will be superimposed on the TV screen.

2 Use ▲/▼ and ENTER to make the desired selection.

■ Input*1

▶ You can select the input source while viewing the information as follows: the name of input selectors, input assignments, radio information, and ARC function setting.

Press **ENTER** to display the current input source, followed by ▲/▼ to select the desired input source. Pressing **ENTER** again switches to the selected input source.

■ Audio

▶ You can change the following settings: “**Bass**”, “**Treble**”, “**Subwoofer Level**”, “**Center Level**”, “**Audyssey**”, “**Dynamic EQ**”, “**Dynamic Volume**”, “**Late Night**”, “**Music Optimizer**” and “**Cinema Filter**”.

See also:

- “**Audyssey**” (→ page 45)
- “**Using the Audio Settings**” (→ page 54)

■ Video

▶ You can change the following settings: “**Wide Mode**” and “**Picture Mode**”².

See also:

- “**Picture Adjust**” (→ page 48)

■ Info*3

▶ You can view the information of the following items: “**Audio**”, “**Video**” and “**Tuner**”.

■ Listening Mode

▶ You can select the listening modes that are grouped in the following categories: **MOVIE/TV**, **MUSIC** and **GAME**.

Use ▲/▼ to select the category and ◀/▶ to select the listening mode. Press **ENTER** to switch to the selected listening mode.

Note

- *1 For the **PORT** input selector, the name of Universal Port Option Dock will be displayed.
- *2 Only when you have selected “**Custom**” in the “**Picture Mode**” (→ page 48), pressing **ENTER** allows you to adjust the following items via the Home menu: “**Brightness**”, “**Contrast**”, “**Hue**” and “**Saturation**”. Press **RETURN** to return to the “**Picture Mode**” setting.
- *3 Depending on the input source and listening mode, not all channels shown here output the sound.

Using the Sleep Timer

With the sleep timer, you can set the AV receiver to turn off automatically after a specified period.

1 Press RECEIVER followed by SLEEP repeatedly to select the required sleep time.

The sleep time can be set from 90 to 10 minutes in 10 minute steps.

The **SLEEP** indicator lights on the display when the sleep timer has been set. The specified sleep time appears on the display for about 5 seconds, then the previous display reappears.

Tip

- If you need to cancel the sleep timer, press **SLEEP** repeatedly until the **SLEEP** indicator goes off.
- To check the time remaining until the AV receiver sleeps, press **SLEEP**. Note that if you press again on **SLEEP** as the time being displayed is equal or inferior to 10 minutes, the sleep timer will go off.

Setting the Display Brightness

You can adjust the brightness of the AV receiver's display.

1 Press RECEIVER followed by DIMMER repeatedly to select: dim, dimmer, or normal brightness.

Tip

- Alternatively, you can use the AV receiver's **DIMMER**.

Displaying Source Information

You can display various information about the current input source as follows. (Components connected to the **UNIVERSAL PORT** jack are excluded.)

- 1 Press **RECEIVER** followed by **DISPLAY** repeatedly to cycle through the available information.

Tip

- Alternatively, you can use the AV receiver's **DISPLAY**.

The following information can typically be displayed.

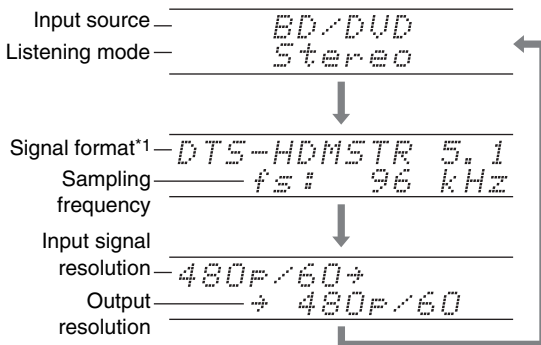

- ^{*1} If the input signal is analog, “Analog” is displayed. If the input signal is PCM, the sampling frequency is displayed. If the input signal is digital but not PCM, the signal format is displayed. Information is displayed for about three seconds, then the previously displayed information reappears.

Changing the Input Display

When you connect an **RI**-capable Onkyo component, you must configure the input display so that **RI** can work properly.

This setting can be done only from the front panel.

- 1 Press **TV/CD**, **GAME** or **VCR/DVR**. “TV/CD”, “GAME” or “VCR/DVR” appears on the display.
- 2 Press and hold down **TV/CD**, **GAME** or **VCR/DVR** (about 3 seconds) to change the input display. Repeat this step to select the desired input display.

■ TV/CD:

TV/CD → DOCK
↑ TAPE ↓

■ GAME:

GAME ↔ DOCK

■ VCR/DVR:

VCR/DVR ↔ DOCK

Note

- **DOCK** can be selected for the **TV/CD**, **GAME** or **VCR/DVR** input selector, but not at the same time.
- Enter the appropriate remote control code before using the remote controller for the first time (→ page 61).

Using the Music Optimizer

The Music Optimizer function enhances the sound quality of compressed music files.

- 1 Press **MUSIC OPTIMIZER** on the front panel. The Music Optimizer and **M.Opt** indicators light on the display.

Tip

- Alternatively, you can use the remote controller's **HOME** and arrow buttons.
- See “Music Optimizer” for more details (→ page 55).

Muting the AV Receiver

You can temporarily mute the output of the AV receiver.

- 1 Press **RECEIVER** followed by **MUTING**. The output is muted and the **MUTING** indicator flashes on the display.

Tip

- To unmute, press **MUTING** again or adjust the volume.
- Muting is automatically cancelled when the AV receiver is set to standby.

Using Headphones

- 1 Connect a pair of stereo headphones with a standard plug (1/4 inch or 6.3 mm) to the PHONES jack.**

Note

- Always turn down the volume before connecting your headphones.
- While the headphones plug is inserted in the **PHONES** jack, the speakers are turned off. (The Powered Zone 2 speakers are not turned off.)
- When you connect a pair of headphones, the listening mode is set to Stereo, unless it's already set to Stereo, Mono, or Direct.
- If you connect an iPod or iPhone to the **USB** port on this device, no sound will be output from the headphones jack.

Recording

This section explains how to record the selected input source to a component with recording capability, and how to record audio and video from different sources.

AV Recording

Audio sources can be recorded to a recorder (e.g., cassette tape deck, CDR, MD recorder). Video sources can be recorded to a video recorder (e.g., VCR, DVD recorder).

- 1 Use the input selector buttons to select the source that you want to record.**

You can watch the source while recording. The AV receiver's **MASTER VOLUME** control has no effect on recording.

- 2 On your recorder, start recording.**

- 3 On the source component, start playback.**

If you select another input source during recording, that input source will be recorded.

Advanced Setup

The on-screen setup menus appear only on a TV that is connected to the HDMI OUT. If your TV is connected to other video outputs, use the AV receiver's display when changing settings.

This section describes the procedure for using the remote controller unless otherwise specified.

On-screen Setup Menus

Menu

- ① 1. Input/Output Assign
- ② 2. Speaker Setup
- ③ 3. Audio Adjust
- ④ 4. Source Setup
- ⑤ 5. Listening Mode Preset
- ⑥ 6. Miscellaneous
- ⑦ 7. Hardware Setup
- ⑧ 8. Remote Controller Setup
- ⑨ 9. Lock Setup

① **Input/Output Assign**
(→ page 40)

1. Input/Output Assign	
1. Monitor Out	
2. HDMI Input	
3. Component Video Input	
4. Digital Audio Input	

⑥ **Miscellaneous**
(→ page 50)

6. Miscellaneous	
1. Volume Setup	
2. OSD Setup	

② **Speaker Setup**
(→ page 41)

2. Speaker Setup	
1. Speaker Settings	
2. Speaker Configuration	
3. Speaker Distance	
4. Level Calibration	

⑦ **Hardware Setup**
(→ page 51)

7. Hardware Setup	
1. Remote ID	
2. Tuner	
3. HDMI	
4. Auto Standby	
5. Network	
6. Firmware Update	

③ **Audio Adjust**
(→ page 44)

3. Audio Adjust	
1. Multiplex/Mono	
2. Dolby	
3. DTS	
4. Theater-Dimensional	

⑧ **Remote Controller Setup**
(→ page 61)

8. Remote Controller Setup	
1. Remote Mode Setup	

④ **Source Setup**
(→ page 45)

4. Source Setup	
1. Audyssey	
2. IntelliVolume	
3. A/V Sync	
4. Name Edit	
5. Picture Adjust	
6. Audio Selector	

⑨ **Lock Setup**
(→ page 54)

9. Lock Setup	
Setup	

⑤ **Listening Mode Preset**
(→ page 50)

5. Listening Mode Preset	
1. BD/DVD	
2. VCR/DVR	
3. CBL/SAT	
4. GAME	
5. AUX	

Common Procedures in Setup Menu

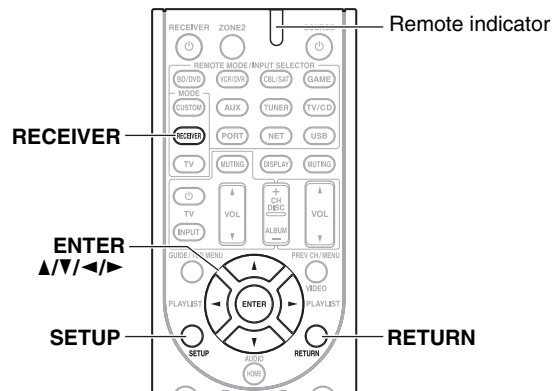

The on-screen setup menus appear on the connected TV and provide a convenient way to change the AV receiver's various settings. Settings are organized into 9 categories on the **main menu**.

Carry out the settings by using the on-screen display.

1 Press RECEIVER followed by SETUP.

Tip

- If the main menu doesn't appear, make sure the appropriate external input is selected on your TV.

2 Use ▲/▼ to select a menu, and then press ENTER.

3 Use ▲/▼ to select a target, and then press ENTER.

4 Use ▲/▼ to select an option, and use ◀/▶ to change the setting.

Press **SETUP** to close the menu.

Press **RETURN** to return to the previous menu.

Note

- This procedure can also be performed on the AV receiver by using **SETUP**, the arrow buttons, and **ENTER**.
- During Audyssey 2EQ® Room Correction and Speaker Setup, messages and alike that are displayed on the TV screen will appear on the display.

Explanatory Notes

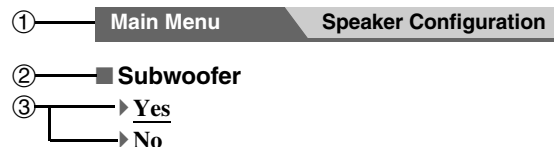

① Menu selection

② Setting target

③ Setting options (default setting underlined)

Monitor Out

You can specify the output resolution for the **HDMI OUT** and have the AV receiver upconvert the picture resolution as necessary to match the resolution supported by your TV.

Resolution

▶ **Through:**

Select this to pass video through the AV receiver at the same resolution and with no conversion.

▶ **Auto:**

Select this to have the AV receiver automatically convert video at resolutions supported by your TV.

▶ **480p, 720p, 1080i, 1080p:**

Select the desired output resolution.

▶ **1080p/24:**

Select this for 1080p output at 24 frames per second.

▶ **4K Upscaling:**

Select this for an output resolution four times that of 1080p, resulting in 3840 × 2160 pixels.

Note

- Depending on the incoming video signal, the video playback may not be smooth or the vertical resolution may be lowered. In this case select anything other than “1080p/24”.

HDMI Input

If you connect a video component to an HDMI input, you must assign that input to an input selector. For example, if you connect your Blu-ray Disc/DVD player to **HDMI IN 2**, you must assign “HDMI2” to the “BD/DVD” input selector.

If you’ve connected your TV to the AV receiver with an HDMI cable, composite video and component video sources can be upconverted* to HDMI. See “Video Connection Formats” for more information on video signal flow and upconversion (→ page 76).

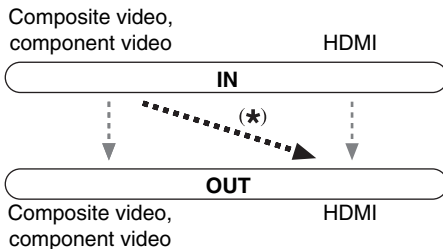

Here are the default assignments.

Input selector	Default assignment
BD/DVD	HDMI1
VCR/DVR	HDMI2
CBL/SAT	HDMI3
GAME	HDMI4
AUX	-----
TV/CD	-----
PORT	-----

BD/DVD, VCR/DVR, CBL/SAT, GAME, AUX, TV/CD, PORT

▶ **HDMI1, HDMI2, HDMI3, HDMI4:**

Select a corresponding HDMI input to which the video component has been connected.

▶ **-----:**

Select this to output composite video and component video sources from the **HDMI OUT**. The video signal from the HDMI output is configured in “Component Video Input” (→ page 41).

Each HDMI input cannot be assigned to two input selectors or more. When **HDMI1 - HDMI4** have already been assigned, you must first set any unused input selectors to “-----” or you will be unable to assign **HDMI1 - HDMI4** to other input selectors.

Note

- When an **HDMI IN** is assigned to an input selector as explained here, the same **HDMI IN** will be set as a priority in the “**Digital Audio Input**” (→ page 41). In this case, if you want to use the coaxial or optical audio input, make the appropriate selection in the “**Audio Selector**” setting (→ page 49).
- The “**TUNER**” selector cannot be assigned and is fixed to the “-----” option.
- Do not assign an **HDMI IN** to the **TV/CD** selector while “**HDMI Control (RIHD)**” is set to “**On**” (→ page 51), otherwise appropriate CEC (Consumer Electronics Control) operation will not be guaranteed.
- If you assign “-----” to an input selector that is currently selected in “**HDMI Through**” (→ page 52), the “**HDMI Through**” setting will be automatically switched to “**Off**”.
- If you connect a component (such as UP-A1 Dock with docked iPod/iPhone) to the **UNIVERSAL PORT** jack, you cannot assign any input to the “**PORT**” selector.

Component Video Input

If you connect a video component to a component video input, you must assign that input to an input selector. For example, if you connect your Blu-ray Disc/DVD player to **COMPONENT VIDEO IN 2**, you must assign “**IN2**” to the “**BD/DVD**” input selector.

Here are the default assignments.

Input selector	Default assignment
BD/DVD	IN1
VCR/DVR	-----
CBL/SAT	IN2
GAME	-----
AUX	-----
TV/CD	-----
PORT	-----

BD/DVD, VCR/DVR, CBL/SAT, GAME, AUX, TV/CD, PORT

IN1, IN2:

Select a corresponding component video input to which the video component has been connected.

-----:

Select if you are using the **HDMI** output, not the component video output, to output composite video and component video sources.

PC IN:

Select if the personal computer is connected to **PC IN**.

Note

- If you connect a component (such as UP-A1 Dock with docked iPod/iPhone) to the **UNIVERSAL PORT** jack, you cannot assign any input to the “**PORT**” selector.
- The “**TUNER**” selector cannot be assigned and is fixed to the “-----” option.

Digital Audio Input

If you connect a component to a digital audio input, you must assign that input to an input selector. For example, if you connect your CD player to the **OPTICAL IN 1**, you must assign “**OPTICAL1**” to the “**TV/CD**” input selector.

Here are the default assignments.

Input selector	Default assignment
BD/DVD	COAXIAL1
VCR/DVR	-----
CBL/SAT	COAXIAL2
GAME	OPTICAL1
AUX	-----
TV/CD	OPTICAL2
PORT	-----

BD/DVD, VCR/DVR, CBL/SAT, GAME, AUX, TV/CD, PORT

COAXIAL1, COAXIAL2, OPTICAL1, OPTICAL2:

Select a corresponding digital audio input to which the component has been connected.

-----:

Select if the component is connected to an analog audio input.

Note

- When an **HDMI IN** is assigned to an input selector in “**HDMI Input**” (→ **page 40**), the same **HDMI IN** will be set as a priority in this assignment. In this case, if you want to use the coaxial or optical audio input, make the selection in the “**Audio Selector**” (→ **page 49**).
- Available sampling rates for PCM signals (stereo/mono) from a digital input (optical and coaxial) are 32/44.1/48/88.2/96 kHz/16, 20, 24 bit.
- If you connect a component (such as UP-A1 Dock with docked iPod/iPhone) to the **UNIVERSAL PORT** jack, you cannot assign any input to the “**PORT**” selector.
- The “**TUNER**” selector cannot be assigned and is fixed to the “-----” option.

Speaker Setup

Main menu

Speaker Setup

Some of the settings in this section are set automatically by Audyssey 2EQ® Room Correction and Speaker Setup (→ **page 28**).

Here you can check the settings made by Audyssey 2EQ Room Correction and Speaker Setup function, or set them manually, which is useful if you change one of the connected speakers after using Audyssey 2EQ Room Correction and Speaker Setup function.

Note

- These settings are not available in either of the following cases:
 - a pair of headphones is connected.
 - the “**Audio TV Out**” setting is set to “**On**” (→ **page 52**).
 - “**HDMI Control (RIHD)**” is set to “**On**” (→ **page 51**) and you’re listening through your TV speakers.

Speaker Settings

If you change these settings, you must run Audyssey 2EQ® Room Correction and Speaker Setup again (→ page 28).

■ Powered Zone 2

▶ No

▶ Yes:

Zone 2 speakers can be used. (Powered Zone 2 enabled).

Note

- Before you change this setting, turn down the volume.
- When the “Powered Zone 2” setting is set to “Yes”, the surround back or front high speakers cannot be used.

Speaker Configuration

With these settings, you can specify which speakers are connected and a crossover frequency for each speaker. Specify “Full Band” for speakers that can output low frequency bass sounds adequately, for example, speakers with a good sized woofer. For smaller speakers, specify a crossover frequency. Sounds below the crossover frequency will be output by the subwoofer instead of the speaker. Refer to your speaker’s manuals to determine the optimum crossover frequencies.

Note

- These settings are not available in either of the following cases:
 - a pair of headphones is connected.
 - the “Audio TV Out” setting is set to “On” (→ page 52).
 - “HDMI Control (RIHD)” is set to “On” (→ page 51) and you’re listening through your TV speakers.

■ Subwoofer

▶ Yes

▶ No

■ Front

▶ Full Band

▶ 40Hz to 100Hz, 120Hz, 150Hz, 200Hz

Note

- If the “Subwoofer” setting is set to “No”, the “Front” setting is fixed to “Full Band”.

■ Center^{*1}, Surround^{*1}, Surround Back^{*2*3*4*5}

▶ Full Band

▶ 40Hz to 100Hz, 120Hz, 150Hz, 200Hz

▶ None

■ Front High^{*1*2*4*6}

▶ Full Band

▶ 40Hz to 100Hz, 120Hz, 150Hz, 200Hz

▶ None

Note

- *1 “Full Band” can be selected only when “Full Band” is selected in the “Front” setting.
- *2 If the “Surround” setting is set to “None”, this setting cannot be selected.
- *3 If the “Surround” setting is set to anything other than “Full Band”, “Full Band” cannot be selected here.
- *4 If the “Powered Zone 2” setting is set to “Yes”, this setting cannot be selected.
- *5 If anything else than “None” is selected in “Front High”, this setting is automatically set to “None”.
- *6 If anything else than “None” is selected in “Surround Back”, this setting is automatically set to “None”.

■ Surround Back Ch

▶ 1ch:

Select if only one surround back speaker L is connected.

▶ 2ch:

Select if two (left and right) surround back speakers are connected.

Note

- If the “Surround Back” Setting is set to “None”, this setting cannot be selected.

■ LPF of LFE

(Low-Pass Filter for the LFE Channel)

▶ 80Hz, 90Hz, 100Hz, 120Hz

▶ Bypass:

Low-Pass Filter is not applied.

With this setting, you can specify the cutoff frequency of the LFE channel’s low-pass filter (LPF), which can be used to filter out unwanted hum. The LPF only applies to sources that use the LFE channel.

■ Double Bass

This setting is **NOT** set automatically by Audyssey 2EQ® Room Correction and Speaker Setup (→ **page 28**).

- ▶ **On**
- ▶ **Off**

Turn this setting on to boost bass output by feeding bass sounds from the front left, right, and center channels to the subwoofer.

Note

- This function can be set only if the “**Subwoofer**” setting is set to “**Yes**”, and the “**Front**” setting is set to “**Full Band**”.

■ Wireless Front High, Wireless Surround Back, Wireless Subwoofer

When an optional unit is connected to the **UNIVERSAL PORT** jack on the AV receiver, the speaker setting menu may appear on screen.

- ▶ **Yes:**
The audio is output from the speakers connected to the wireless unit.
- ▶ **No:**
The audio is not output from the speakers connected to the wireless unit.

When the wireless unit is connected to the **UNIVERSAL PORT** jack on the AV receiver, you can select if you wish to output the audio from the speakers connected to the wireless unit.

Note

- If the “**Front High**” setting is set to “**None**” (→ **page 42**), “**Wireless Front High**” cannot be selected.
- If the “**Surround Back**” setting is set to “**None**” (→ **page 42**), “**Wireless Surround Back**” cannot be selected.
- If the “**Subwoofer**” setting is set to “**No**” (→ **page 42**), “**Wireless Subwoofer**” cannot be selected.

Speaker Distance

This setting is set automatically by Audyssey 2EQ Room Correction and Speaker Setup (→ **page 28**).

Here you can specify the distance from each speaker to the listening position so that the sound from each speaker arrives at the listener’s ears as the sound designer intended.

■ Unit

- ▶ **feet:**
Distances can be set in feet. Range: **1.0ft** to **30.0ft** in 1 foot steps.
- ▶ **meters:**
Distances can be set in meters. Range: **0.30m** to **9.00m** in 0.3 meter steps.

■ Left, Front High Left, Center, Front High Right, Right, Surround Right, Surround Back Right, Surround Back Left, Surround Left, Subwoofer

- ▶ Specify the distance from each speaker to your listening position.

Note

- These settings are not available in either of the following cases:
 - a pair of headphones is connected.
 - the “**Audio TV Out**” setting is set to “**On**” (→ **page 52**).
 - “**HDMI Control (RIHD)**” is set to “**On**” (→ **page 51**) and you’re listening through your TV speakers.
- Speakers that you set to “**No**” or “**None**” in the “**Speaker Configuration**” cannot be selected (→ **page 42**).

Level Calibration

This setting is set automatically by Audyssey 2EQ Room Correction and Speaker Setup (→ **page 28**).

Here you can adjust the level of each speaker with the built-in test tone so that the volume of each speaker is the same at the listening position.

■ Left, Front High Left, Center*1, Front High Right, Right, Surround Right, Surround Back Right, Surround Back Left, Surround Left

- ▶ **-12dB** to **0dB** to **+12dB** in 1 dB steps.

■ Subwoofer*1

- ▶ **-15dB** to **0dB** to **+12dB** in 1 dB steps.

Note

- These settings cannot be calibrated in either of the following cases:
 - a pair of headphones is connected.
 - the “**Audio TV Out**” setting is set to “**On**” (→ **page 52**).
 - “**HDMI Control (RIHD)**” is set to “**On**” (→ **page 51**) and you’re listening through your TV speakers.
 - the AV receiver is muted.
- Speakers that you set to “**No**” or “**None**” in the “**Speaker Configuration**” cannot be selected (→ **page 42**).
- *1 For the center speaker and subwoofer, the level settings made by using the Home menu are saved in this menu (→ **page 36**).

Tip

- If you’re using a handheld sound level meter, adjust the level of each speaker so that it reads 75 dB SPL at the listening position, measured with C-weighting and slow reading.

With the Audio Adjust functions and settings, you can adjust the sound and listening modes as you like.

Multiplex/Mono

■ Multiplex

Input Channel

▶ **Main**

▶ **Sub**

▶ **Main/Sub**

This setting determines which channel of a stereo multiplex source is output. Use it to select audio channels or languages with multiplex sources, multilingual TV broadcasts, and so on.

■ Mono

Input Channel

▶ **Left + Right**

▶ **Left**

▶ **Right**

This setting specifies the channel to be used for playing any 2-channel digital source such as Dolby Digital, or 2-channel analog/PCM source in the Mono listening mode.

Dolby

■ PL IIx Music (2ch Input)

These settings apply to only 2-channel stereo sources. If you're not using any surround back speakers, these settings apply to Dolby Pro Logic II, not Dolby Pro Logic IIx.

Panorama

▶ **On**

▶ **Off**

With this setting, you can broaden the width of the front stereo image when using the Dolby Pro Logic IIx Music listening mode.

Dimension

▶ **-3 to 0 to +3**

With this setting, you can move the sound field forward or backward when using the Dolby Pro Logic IIx Music listening mode. Higher settings move the sound field backward. Lower settings move it forward.

If the stereo image feels too wide, or there's too much surround sound, move the sound field forward to improve the balance. Conversely, if the stereo image feels like it's in mono, or there's not enough surround sound, move it backward.

Center Width

▶ **0 to 3 to 7**

With this setting, you can adjust the width of the sound from the center speaker when using the Dolby Pro Logic IIx Music listening mode. Normally, if you're using a center speaker, the center channel sound is output from only the center speaker. (If you're not using a center speaker, the center channel sound will be distributed to the front left and right speakers to create a phantom center). This setting controls the front left, right, and center mix, allowing you to adjust the weight of the center channel sound.

■ PL IIz Height Gain

▶ **Low**

▶ **Mid**

▶ **High**

The Height Gain Control in Dolby Pro Logic IIz enables the listener to select how much gain is applied to the front high speakers. There are three settings, "**Low**", "**Mid**" and "**High**", and the front high speakers are accentuated in that order. While "**Mid**" is the default listening setting, the listener may adjust the Height Gain Control to their personal preference.

Note

- If the "**Front High**" settings is set to "**None**" (→ **page 42**), this setting cannot be selected.

■ Dolby EX

Dolby EX

▶ **Auto:**

If the source signal contains a Dolby EX flag, the Dolby EX listening mode is used.

▶ **Manual:**

You can select any available listening mode.

This setting determines how Dolby EX encoded signals are handled. This setting is unavailable if no surround back speakers are connected. This setting is effective with Dolby Digital, Dolby Digital Plus and Dolby TrueHD only.

Note

- If the "**Surround Back**" setting is set to "**None**" (→ **page 42**), this setting cannot be selected.
- If the "**Front High**" setting is enabled (→ **page 42**), this setting is fixed to "**Manual**".

■ Neo:6 Music

Center Image

▶ 0 to 2 to 5

The DTS Neo:6 Music listening mode creates 6-channel surround sound from 2-channel stereo sources. With this setting, you can specify by how much the front left and right channel output is attenuated in order to create the center channel.

Changing the value from “0” to “5” will spread the sound of the center channel to left and right (outwards).

Theater-Dimensional

■ Listening Angle

▶ Wide:

Select if the listening angle is 40 degrees.

▶ Narrow:

Select if the listening angle is 20 degrees.

With this setting, you can optimize the Theater-Dimensional listening mode by specifying the angle of the front left and right speakers relative to the listening position. Ideally, the front left and right speakers should be equidistant from the listening position and at an angle close to one of the two available settings.

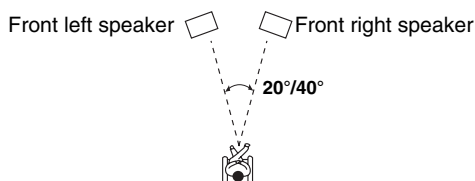

Source Setup

Items can be set individually for each input selector.

Preparation

Press the input selector buttons to select an input source.

Main menu

Source Setup

Audyssey

The tone for each speaker is set automatically by Audyssey 2EQ® Room Correction and Speaker Setup. To enable the following settings, you must first perform the Room Correction and Speaker Setup (→ [page 28](#)).

■ Audyssey

▶ Off

▶ Movie:

Select this setting for movie material.
The **Audyssey** indicator lights.

▶ Music:

Select this setting for music material.
The **Audyssey** indicator lights.

Note

- When “**Audyssey Quick Start**” has been used for measurement, the “**Audyssey**” setting cannot be selected.
- Audyssey equalizing does not work with DSD sources.
- These technologies cannot be used when:
 - a pair of headphones is connected, or
 - Direct listening mode is selected.

■ Dynamic EQ

▶ Off

▶ On:

Audyssey Dynamic EQ® becomes active.
The **Dynamic EQ** indicator lights.

With Audyssey Dynamic EQ, you can enjoy great sound even when listening at low volume levels.

Audyssey Dynamic EQ solves the problem of deteriorating sound quality as volume is decreased by taking into account human perception and room acoustics. It does so by selecting the correct frequency response and surround volume levels moment-by-moment so that the content sounds the way it was created at any volume level — not just at reference level.

Note

- These technologies cannot be used when:
 - a pair of headphones is connected, or
 - Direct listening mode is selected.

■ Reference Level

Audyssey Dynamic EQ® Reference Level Offset

▶ **0dB:**

This should be used when listening to movies.

▶ **5dB:**

Select this setting for content that has a very wide dynamic range, such as classical music.

▶ **10dB:**

Select this setting for jazz or other music that has a wider dynamic range. This setting should also be selected for TV content as that is usually mixed at 10 dB below film reference.

▶ **15dB:**

Select this setting for pop/rock music or other program material that is mixed at very high listening levels and has a compressed dynamic range.

Movies are mixed in rooms calibrated for film reference. To achieve the same reference level in a home theater system each speaker level must be adjusted so that -30 dBFS band-limited (500 Hz to 2000 Hz) pink noise produces 75 dB sound pressure level at the listening position. A home theater system automatically calibrated by Audyssey 2EQ® will play at reference level when the master volume control is set to the 0 dB position. At that level you can hear the mix as the mixers heard it.

Audyssey Dynamic EQ is referenced to the standard film mix level. It makes adjustments to maintain the reference response and surround envelopment when the volume is turned down from 0 dB. However, film reference level is not always used in music or other non-film content. Audyssey Dynamic EQ Reference Level Offset provides three offsets from the film level reference (5 dB, 10 dB, and 15 dB) that can be selected when the mix level of the content is not within the standard.

Note

- If “**Dynamic EQ**” setting is set to “**Off**”, these technologies cannot be used.

■ Dynamic Volume

▶ **Off**

▶ **Light:**

Activates Light Compression Mode.

▶ **Medium:**

Activates Medium Compression Mode.

▶ **Heavy:**

Activates Heavy Compression Mode. This setting affects volume the most. It quiets the loud parts, such as explosions, and boosts the quiet parts so they can be heard.

Note

- If you make Dynamic Volume active, “**Dynamic EQ**” is set to “**On**”. The **Dynamic Vol** indicator will light.
- When “**Dynamic EQ**” is set to “**Off**”, “**Dynamic Volume**” is automatically switched to “**Off**”.
- These technologies cannot be used when:
 - a pair of headphones is connected, or
 - Direct listening mode is selected.

About Audyssey Dynamic EQ®

Audyssey Dynamic EQ solves the problem of deteriorating sound quality as volume is decreased by taking into account human perception and room acoustics. Dynamic EQ selects the correct frequency response and surround levels moment-by-moment at any user-selected volume setting. The result is bass response, tonal balance, and surround impression that remain constant despite changes in volume. Dynamic EQ combines information from incoming source levels with actual output sound levels in the room, a prerequisite for delivering a loudness correction solution. Audyssey Dynamic EQ works well by itself. However, if Audyssey 2EQ is on, the two technologies work in tandem to provide well-balanced sound for every listener at any volume level.

About Audyssey Dynamic Volume®

Audyssey Dynamic Volume solves the problem of large variations in volume level between television programs, commercials, and between the soft and loud passages of movies. Dynamic Volume looks at the preferred volume setting by the user and then monitors how the volume of program material is being perceived by listeners in real time to decide whether an adjustment is needed. Whenever necessary, Dynamic Volume makes the necessary rapid or gradual adjustments to maintain the desired playback volume level while optimizing the dynamic range. Audyssey Dynamic Volume works fine by itself, but can also be used with Audyssey Dynamic EQ. When both are on, Audyssey Dynamic EQ adjusts the perceived bass response, tonal balance, surround impression, and dialog clarity whether watching movies, flipping between television channels, or changing from stereo to surround sound content, when Dynamic Volume adjusts the volume.

IntelliVolume

IntelliVolume

▶ **-12dB** to **0dB** to **+12dB** in 1 dB steps.

With IntelliVolume, you can set the input level for each input selector individually. This is useful if one of your source components is louder or quieter than the others.

Use ◀/▶ to set the level.

If a component is noticeably louder than the others, use ◀ to reduce its input level. If it's noticeably quieter, use ▶ to increase its input level.

A/V Sync

A/V Sync

▶ **0msec** to **800msec** in 10 msec steps.

When using progressive scanning on your Blu-ray Disc/DVD player, you may find that the picture and sound are out of sync. With this setting, you can correct this by delaying the audio signals.

To view the TV picture while setting the delay, press **ENTER**.

To return to the previous screen, press **RETURN**.

The range of values you can adjust will depend on whether your TV or display supports HDMI Lip Sync and if the "**Lip Sync**" setting is set to "**On**" or not (→ [page 52](#)).

Note

- A/V Sync is disabled when the Direct listening mode is used with an analog input source.
- This setting cannot be used with the **NET** input selector.

Name Edit

You can enter a custom name for each individual input selector and radio preset for easy identification. When entered, the custom name will appear on the display. The custom name is edited using the character input screen.

Name

- 1** Use ▲/▼/◀/▶ to select a character, and then press **ENTER**.
Repeat this step to enter up to 10 characters.
- 2** To store a name when you're done, be sure to select "**OK**" by using ▲/▼/◀/▶, and then press **ENTER**.

Name input area

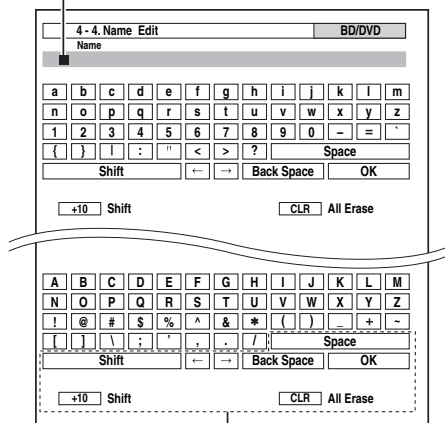

Space:

Enter a space character.

Shift*1:

Toggles between lower and upper case characters.

← (Left)/ → (Right):

Moves the cursor left or right in the Name input area.

Back Space*2:

Moves the cursor backward and deletes one character.

OK:

Confirms your entry.

Tip

- *1 This can also be performed by using **+10** on the remote controller.
- *2 Press **CLR** on the remote controller to delete all the characters you have input.

To correct a character:

- 1** Use ▲/▼/◀/▶ to select "←"(Left) or "→"(Right), and then press **ENTER**.
- 2** Press **ENTER** several times to highlight the incorrect character (For each pressure, the cursor is moved on the next character).
- 3** Use ▲/▼/◀/▶ to select the correct character, and then press **ENTER**.

Tip

- To name a radio preset, use **TUNER** to select AM or FM, and then select the preset (→ [page 27](#)).
- To restore a custom name to its default, erase the custom name by entering an empty white space for each letter.

Note

- This setting cannot be used for the **NET** and **USB** input selector.

Picture Adjust

Using Picture Adjust, you can adjust the picture quality and reduce any noise appearing on the screen.

To view the TV picture while setting, press **ENTER**. To return to the previous screen, press **RETURN**.

■ Wide Mode^{*1*2}

This setting determines the aspect ratio.

▶ 4:3:

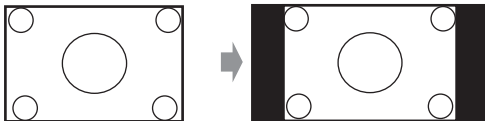

▶ Full:

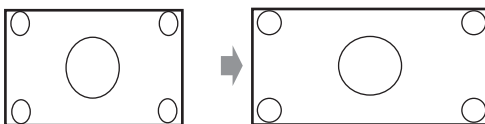

▶ Zoom:

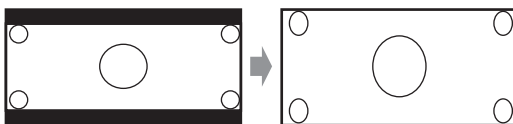

▶ Wide Zoom:

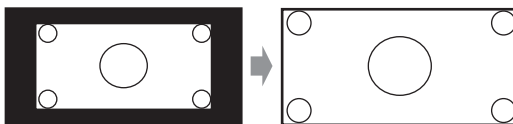

▶ Auto:

According to the input signals and monitor output setting, the AV receiver automatically selects the “4 : 3”, “Full”, “Zoom” or “Wide Zoom” mode. See “Monitor Out” for details on the monitor output setting (→ **page 40**).

■ Picture Mode^{*1}

▶ Custom:

All settings can be performed manually.

▶ Cinema:

Select when the picture source is a movie or alike.

▶ Game:

Select when the video source is a game console.

▶ Through:

Does not adjust picture quality (changes resolution).

▶ Direct:

Does not adjust picture quality (does not change resolution).

When video is output from HDMI OUT, it is processed the same as “Through”.

With “Picture Mode”, you can change the following settings to be suitable for the movie or game screen by one operation: “Game Mode”, “Film Mode”, “Edge Enhancement”, “Noise Reduction”, “Brightness”, “Contrast”, “Hue”, “Saturation” or “Color Temperature”.

■ Game Mode^{*3*4*5}

▶ Off

▶ On

If video signal delay occurs during playback on a video component (i.e., game console), select the corresponding input source and set the “Game Mode” setting to “On”. The delay will decrease but in return the picture quality will become poor.

■ Film Mode^{*3*5}

▶ Video:

“Film Mode” detection is not applied and the input signal is handled as a video source.

▶ Auto:

Detects whether the input signal is a video or a movie. If it is a movie, the appropriate conversion is applied.

The AV receiver will adjust to the picture source, automatically converting it to the appropriate progressive signal and reproducing the natural quality of the original picture.

■ Edge Enhancement^{*3*5*6*7}

▶ Off

▶ Low

▶ Mid

▶ High

With Edge Enhancement, you can make the picture appear sharper.

■ Noise Reduction^{*3*5*6*7}

▶ Off

▶ Low

▶ Mid

▶ High

With this setting, you can reduce noise appearing on the screen. Select the desired level.

■ Brightness^{*1*3*5}

▶ -50 to 0 to +50

With this setting you can adjust the picture brightness. “-50” is the darkest. “+50” is the brightest.

■ Contrast^{*1*3*5}

▶ -50 to 0 to +50

With this setting you can adjust contrast. “-50” is the least. “+50” is the greatest.

■ Hue^{*1*3*5}

▶ -50 to 0 to +50

With this setting you can adjust the red/green balance. “-50” is the strongest green. “+50” is the strongest red.

■ Saturation^{*1*3*5}

▶ -50 to 0 to +50

With this setting you can adjust saturation. “-50” is the weakest color. “+50” is the strongest color.

■ Color Temperature^{*3*5}

▶ Warm

▶ Normal

▶ Cool

With this setting you can adjust the color temperature.

Note

- “**Picture Adjust**” cannot be used with the **NET** input selector.
- *1 This procedure can also be performed on the remote controller by using the Home menu (→ **page 36**).
- *2 When a 3D video source is input, “**Wide Mode**” is fixed to “**Full**”.
- *3 When the “**Picture Mode**” setting is set to anything other than “**Custom**”, this setting cannot be used.
- *4 If the “**Resolution**” setting is set to “**4K Upscaling**” (→ **page 40**), this setting is fixed to “**Off**”.
- *5 Press **CLR** if you want to reset to the default value.
- *6 If you are using the analog RGB input, this setting is not available.
- *7 If the “**Game Mode**” setting is set to “**On**”, this setting is fixed to “**Off**”.

Audio Selector

You can set priorities of audio output when there are both digital and analog inputs.

■ Audio Selector

▶ **ARC**:

The audio signal from your TV tuner can be sent to the **HDMI OUT** of the AV receiver.*1
With this selection, the TV’s audio can be automatically selected as a priority among other assignments.

▶ **HDMI**:

This can be selected when **HDMI IN** has been assigned as an input source. If both HDMI (**HDMI IN**) and digital audio inputs (**COAXIAL IN** or **OPTICAL IN**) have been assigned, HDMI input is automatically selected as a priority.

▶ **COAXIAL**:

This can be selected when **COAXIAL IN** has been assigned as an input source. If both coaxial and HDMI inputs have been assigned, coaxial input is automatically selected as a priority.

▶ **OPTICAL**:

This can be selected when **OPTICAL IN** has been assigned as an input source. If both optical and HDMI inputs have been assigned, optical input is automatically selected as a priority.

▶ **Analog**:

The AV receiver always outputs analog signals.

Note

- The setting is stored individually for each input selector.
- This setting can be made only for the input source that is assigned as **HDMI IN**, **COAXIAL IN**, or **OPTICAL IN**.
- The “**Audio Selector**” settings cannot be used with the **NET**, **USB** and **PORT** (with connected component) input selectors.
- *1 You can select “**ARC**” if you select the **TV/CD** input selector. But you cannot if you’ve selected “**Off**” in the “**Audio Return Channel**” setting (→ **page 52**).

■ Fixed Mode

▶ **Off**:

The format is detected automatically. If no digital input signal is present, the corresponding analog input is used instead.

▶ **PCM**:

Only 2-channel PCM format input signals will be heard. If the input signal is not PCM, the **PCM** indicator will flash and noise may also be produced.

▶ **DTS**:

Only DTS (but not DTS-HD) format input signals will be heard. If the input signal is not DTS, the **DTS** indicator will flash and there will be no sound.

When “**HDMI**”, “**COAXIAL**” or “**OPTICAL**” is selected in the “**Audio Selector**” setting, you can then specify the signal type in “**Fixed Mode**”.

Normally, the AV receiver detects the signal format automatically. However, if you experience either of the following issues when playing PCM or DTS material, you can manually set the signal format to PCM or DTS.

- If the beginnings of tracks from a PCM source are cut off, try setting the format to PCM.
- If noise is produced when fast forwarding or reversing a DTS CD, try setting the format to DTS.

Note

- The setting is stored individually for each input selector.
- The setting will be reset to “**Off**” when you change the setting in “**Audio Selector**”.

Charge Mode

■ Charge Mode

▶ **Auto**:

Power feeding is interrupted when your iPod/iPhone is fully charged.

▶ **On**:

Power feeding continues even if your iPod/iPhone is fully charged.

▶ **Off**:

Your iPod/iPhone is not charged.

You can specify how the power is fed to your iPod/iPhone when the AV receiver is in standby mode.

Note

- This setting cannot be selected when:
 - the UP-A1 Dock with docked iPod/iPhone is not connected to the AV receiver, or
 - the docked iPod/iPhone model is not supported.
- When the “**Charge Mode**” setting is set to “**On**”, or to “**Auto**” with your iPod/iPhone recharging, the **SLEEP** indicator is dimly lit in standby mode. In such conditions, the power consumption of the AV receiver slightly increases.

Listening Mode Preset

You can assign a default listening mode to each input source that will be selected automatically when you select each input source. For example, you can set the default listening mode to be used with Dolby Digital input signals. You can select other listening modes during playback, but the mode specified here will be resumed once the AV receiver has been set to standby.

Main menu Listening Mode Preset

- 1 Use ▲/▼ to select the input source that you want to set, and then press ENTER.

The following menu appears.

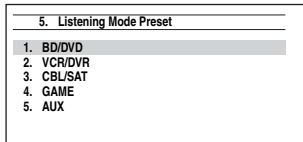

- 2 Use ▲/▼ to select the signal format that you want to set, and then use ◀/▶ to select a listening mode.

Only listening modes that can be used with each input signal format can be selected (→ pages 32 to 35).

The “**Last Valid**” option means that the listening mode selected last will be used.

Note

- If you connect an input component (such as UP-A1 series Dock that seated iPod) to the **UNIVERSAL PORT** jack, the only listening modes you can assign to the “PORT” selector are specific to analog sound.
- For the **TUNER** input selector, only “Analog” will be available.
- For the **NET** or **USB** input selector, only “Digital” will be available.

■ Analog/PCM/Digital

With this setting, you can specify the listening mode used when an analog (CD, TV, LD, VHS, MD, turntable, radio, cassette, cable, satellite, etc.) or PCM digital (CD, DVD, etc.) audio signal is played.

■ Mono/Multiplex Source

With this setting, you can specify the listening mode used when a mono digital audio signal is played (DVD, etc.).

■ 2ch Source

With this setting, you can specify the listening mode used when 2-channel (2/0) stereo digital sources, such as Dolby Digital or DTS, are played.

■ Dolby D/Dolby D Plus/TrueHD

With this setting, you can specify the listening mode used when Dolby Digital or Dolby Digital Plus format digital audio signals are played (DVD, etc.). Specifies the default listening mode for Dolby TrueHD sources, such as Blu-ray or HD DVD (input via HDMI).

■ DTS/DTS-ES/DTS-HD

With this setting, you can specify the listening mode used when DTS or DTS-HD High Resolution format digital audio signals are played (DVD, LD, CD, etc.). Specifies the default listening mode for DTS-HD Master Audio sources, such as Blu-ray or HD DVD (input via HDMI).

■ Other Multich Source

Specifies the default listening mode for multichannel PCM sources from **HDMI IN** such as DVD-Audio, and DSD multichannel sources such as Super Audio CD.

Miscellaneous

Main menu Miscellaneous

Volume Setup

■ Maximum Volume

▶ Off, 30 to 79

With this setting, you can limit the maximum volume. To disable this setting, select “Off”.

■ Power On Volume

▶ Last, Min, 1 to 79 or Max

With this preference, you can specify the volume setting to be used each time the AV receiver is turned on. To use the same volume level that was used when the AV receiver was turned off, select “Last”.

The “**Power On Volume**” cannot be set higher than the “**Maximum Volume**” setting.

■ Headphone Level

▶ -12dB to 0dB to +12dB

With this preference, you can specify the headphone volume relative to the main volume. This is useful if there’s a volume difference between your speakers and your headphones.

OSD Setup

■ On Screen Display

▶ On
▶ Off

This preference determines whether operation details are displayed on-screen when an AV receiver function is adjusted.

Even when “On” is selected, operation details may not be output if the input source is connected to an **HDMI IN**.

■ Language

▶ English, Deutsch, Français, Español, Italiano, Nederlands, Svenska

This setting determines the language used for the on-screen setup menus.

Remote ID

Remote ID

- ▶ 1, 2, or 3

When several Onkyo components are used in the same room, their remote ID codes may overlap. To differentiate the AV receiver from the other components, you can change its remote ID from “1”, to “2” or “3”.

Note

- If you do change the AV receiver’s remote ID, be sure to change the remote controller to the same ID (see below), otherwise, you won’t be able to control it with the remote controller.

Changing the remote controller’s ID

- 1** While holding down **RECEIVER**, press and hold down **SETUP** until the remote indicator lights (about 3 seconds) (→ page 39).
- 2** Use the number buttons to enter ID 1, 2, or 3. The remote indicator flashes twice.

Tuner

For AM/FM tuning to work properly, you must specify the AM/FM frequency step used in your area. Note that when this setting is changed, all radio presets will be deleted.

AM/FM Frequency Step

- ▶ **10kHz/200kHz:**
- ▶ **9kHz/50kHz:**

Select the frequency step according to your area.

HDMI

HDMI Control (RIHD)

- ▶ **Off**
- ▶ **On**

Turn this setting on to allow **RIHD**-compatible components connected via HDMI to be controlled by the AV receiver (→ page 79).

Note

- When the setting is set to “**On**” and the menu is closed, the names of connected **RIHD**-compatible components and “**RIHD On**” are displayed on the AV receiver. “**Search...**” → “(name)” → “**RIHD On**”
When the AV receiver cannot receive the name of the component, it is displayed as “**Player***” or “**Recorder***”, etc (“*” shows up and indicates the number of components, when two or more are received).
- When an **RIHD**-compatible component is connected to the AV receiver via an HDMI cable, the name of the connected component is displayed on the AV receiver display. For example, while you are watching TV broadcasting, if you operate a Blu-ray Disc/DVD player (being powered on) with the remote control of the AV receiver, the name of the Blu-ray Disc/DVD player will be displayed on the AV receiver.
- Set it to “**Off**” when a connected piece of equipment is not compatible or it is unclear whether the equipment is compatible or not.
- If operation is not normal when set to “**On**”, change the setting to “**Off**”.
- Refer to the connected component’s instruction manual for details.
- When “**HDMI Control (RIHD)**” setting is set to “**On**”, the power consumption on standby mode slightly increases. (Depending on the TV status, the AV receiver will enter standby mode as usual.)

■ HDMI Through

▶ Off

▶ Auto:

Detects the signal and automatically selects the input source.

▶ BD/DVD, VCR/DVR, CBL/SAT, GAME, AUX, TV/CD, PORT:

Selects the input source for which the HDMI Through function is enabled.

▶ Last:

The HDMI Through function is activated on the input source selected at the time of setting the AV receiver to standby mode.

When enabling the HDMI Through function, regardless of whether the AV receiver is on or in standby, both audio and video streams from an HDMI input will be output to the TV or other components via HDMI connection. The **HDMI THRU** and **HDMI** indicators light when enabled (**HDMI** is dimly-lit).

This setting is set to “**Auto**” automatically when the above “**HDMI Control (RIHD)**” is set to “**On**”.

Note

- Only the input source assigned to the **HDMI IN** via “**HDMI Input**” is enabled (→ **page 40**).
- The power consumption during standby mode will increase during the HDMI Through function: however in the following cases, the power consumption can be saved:
 - The TV is in standby mode.
 - You are watching a TV program.
- Refer to the connected component’s instruction manual for details.
- Depending on the connected component, the correct input source may not be selected with the setting set to “**Auto**”.
- This setting is set to “**Off**” automatically when the “**HDMI Control (RIHD)**” setting is set to “**Off**”.

■ Audio TV Out

▶ Off

▶ On

This preference determines whether the incoming audio signal is output from the HDMI output. You may want to turn this preference on if your TV is connected to the HDMI output and you want to listen to the audio from a connected component through your TV’s speakers. Normally, this should be set to “**Off**”.

Note

- If “**On**” is selected and the audio can be output from the TV, the AV receiver will output no sound through its speakers. In this case, “**TV Speaker**” appears on the display by pressing **DISPLAY**.
- When “**HDMI Control (RIHD)**” is set to “**On**”, this setting is fixed to “**Auto**”.
- With some TVs and input signals, no sound may be output even when this setting is set to “**On**”.
- When “**Audio TV Out**” or “**HDMI Control (RIHD)**” is set to “**On**” and you’re listening through your TV’s speakers (→ **page 15**), turning up the AV receiver’s volume control will make the sound be output from the AV receiver’s front left and right speakers. To stop the AV receiver’s speakers producing sound, change the settings, change your TV’s settings, or turn down the AV receiver’s volume.

■ Audio Return Channel

▶ Off

▶ Auto:

The audio signal from your TV tuner can be sent to the **HDMI OUT** of the AV receiver.

The audio return channel (ARC) function allows an ARC capable TV to send the audio stream to the **HDMI OUT** of the AV receiver. To use this function, you must select the **TV/CD** input selector and your TV must be ARC capable.

Note

- If you set “**Audio Return Channel**” to “**Auto**”, the “**Audio Selector**” settings of the **TV/CD** input selector will be automatically switched to “**ARC**” (→ **page 49**).
- The “**Audio Return Channel**” setting can be set only when the “**HDMI Control (RIHD)**” setting is set to “**On**”.
- This setting is set to “**Auto**” automatically when the “**HDMI Control (RIHD)**” is set to “**On**” for the first time.

■ Lip Sync

▶ Off

▶ On

This function allows the AV receiver to automatically correct any delay between the video and the audio, based on the data from the connected monitor.

Note

- This function works only if your HDMI-compatible TV supports HDMI Lip Sync.

After changing the settings of the “**HDMI Control (RIHD)**”, “**HDMI Through**” or “**Audio Return Channel**” turn off the power on all connected pieces of equipment and then turn them on again. Refer to the user’s manuals for all connected pieces of equipment.

Auto Standby

■ Auto Standby

▶ Off

▶ On

When “**Auto Standby**” is set to “**On**”, the AV receiver will automatically enter standby mode if there is no operation for 30 minutes with no audio and no video signal input.

“**Auto Standby**” will appear on the display and OSD 30 seconds before the Auto Standby comes on.

Note

- Set to “**On**”, the Auto Standby function may activate itself during playback with some sources.
- The Auto Standby function does not work when Zone 2 is on.

Network

After modifying the network settings, you must confirm the changes by executing “**Save**”.

This section explains how to configure the AV receiver’s network settings manually.

If your router’s DHCP server is enabled, you don’t need to change any of these settings, as the AV receiver is set to use DHCP to configure itself automatically by default (i.e., DHCP is set to “**Enable**”). If, however, your router’s DHCP server is disabled (you’re for example using static IP), you’ll need to configure these settings yourself, in which case, a knowledge of Ethernet networking is essential.

What’s DHCP?

DHCP (Dynamic Host Configuration Protocol) is used by routers, computers, the AV receiver, and other devices to automatically configure themselves on a network.

What’s DNS?

The DNS (Domain Name System) translates domain names into IP addresses. For example, when you enter a domain name such as *www.onkyousa.com* in your Web browser, before accessing the site, your browser uses DNS to translate this into an IP address, in this case 63.148.251.142.

■ MAC Address

This is the AV receiver’s MAC (Media Access Control) address. This address cannot be changed.

■ DHCP

- ▶ **Enable**
- ▶ **Disable**

This setting determines whether or not the AV receiver uses DHCP to automatically configure its IP Address, Subnet Mask, Gateway, and DNS Server settings.

Note

- If you select “**Disable**”, you must configure the “**IP Address**”, “**Subnet Mask**”, “**Gateway**”, and “**DNS Server**” settings yourself.

■ IP Address

- ▶ Class A:
“**10.0.0.0**” to “**10.255.255.255**”
- ▶ Class B:
“**172.16.0.0**” to “**172.31.255.255**”
- ▶ Class C:
“**192.168.0.0**” to “**192.168.255.255**”

Enter a static IP address provided by your ISP. Most routers use Class C IP addresses.

■ Subnet Mask

Enter the subnet mask address provided by your ISP (typically **255.255.255.0**).

■ Gateway

Enter the gateway address provided by your ISP.

■ DNS Server

Enter the DNS server address provided by your ISP.

■ Proxy URL

To use a Web proxy, enter its URL here.

■ Proxy Port

If you’re using a Web proxy, enter a proxy port number here.

■ Network Control

- ▶ **Enable**
- ▶ **Disable**

This setting enables or disables control over the network.

Note

- When set to “**Enable**”, the **NET** indicator is dimly-lit and the power consumption slightly increases in standby mode.

■ Control Port

- ▶ “**49152**” to “**65535**”

This is the network port used for control over the network.

Note

- When the “**Network Control**” setting is set to “**Disable**”, this setting is cannot be selected.

Firmware Update

See “Firmware Update” for the update procedure (→ **page 73**).

Note

- Perform the firmware update only when such an announcement is posted on the Onkyo web site. Visit the Onkyo web site for the latest information.
- It takes maximum 60 minutes to complete the firmware update.

■ Version

Displays the current version of the firmware.

■ Receiver

- ▶ **via NET:**
Performs the firmware update via Internet. Check the network connection before updating.
- ▶ **via USB:**
Performs the firmware update from a USB device.

These settings allow you to update the AV receiver’s firmware. Do not shutdown the power of the AV receiver while updating.

■ Universal Port

- ▶ **via NET:**
Performs the firmware update via Internet. Check the network connection before updating.
- ▶ **via USB:**
Performs the firmware update from a USB device.

These settings allow you to update Onkyo dock’s firmware. Do not shutdown the power of the AV receiver while updating.

Note

- This update shall not be performed when no dock is connected to the **UNIVERSAL PORT** jack.

Remote Controller Setup

Main menu

Remote Controller Setup

Remote Mode Setup

See “Looking up for Remote Control Code” (→ [page 61](#)).

Lock Setup

With this preference, you can protect your settings by locking the setup menus.

Main menu

Lock Setup

■ Setup

- ▶ **Locked**
- ▶ **Unlocked**

When “**Locked**” is selected, the setup menus will be locked and you cannot change any setting.

Using the Audio Settings

You can change various audio settings from the Home menu (→ [page 36](#)).

- 1 Press **RECEIVER** followed by **HOME**.
- 2 Use **▲/▼** and **ENTER** to select “**Audio**”, and then use **▲/▼/◀/▶** to make the desired selection.

Note

- These settings are not available in either of the following cases:
 - a pair of headphones is connected.
 - the “**Audio TV Out**” setting is set to “**On**” (→ [page 52](#)).
 - “**HDMI Control (RIHD)**” is set to “**On**” (→ [page 51](#)) and you’re listening through your TV speakers.

Tone Control Settings

■ Bass

- ▶ **-10dB** to **0dB** to **+10dB** in 2 dB steps.
You can boost or cut low-frequency sounds output from the front speakers.

■ Treble

- ▶ **-10dB** to **0dB** to **+10dB** in 2 dB steps.
You can boost or cut high-frequency sounds output from the front speakers.

You can adjust the bass and treble for the front speakers, except when the Direct is selected.

Operating on the AV receiver

- 1 Press **TONE** repeatedly to select either “**Bass**” or “**Treble**”.
- 2 Use **+** and **-** to adjust.

Speaker Levels

■ Subwoofer Level

- ▶ **-15dB** to **0dB** to **+12dB** in 1 dB steps.

■ Center Level

- ▶ **-12dB** to **0dB** to **+12dB** in 1 dB steps.

You can adjust the volume of each speaker while listening to an input source.

These temporary adjustments are cancelled when the AV receiver is set to standby. To save the setting you made here, go to “**Level Calibration**” (→ [page 43](#)) before setting the AV receiver to standby.

Note

- You cannot use this function while the AV receiver is muted.
- Speakers that are set to “**No**” or “**None**” in “**Speaker Configuration**” (→ [page 42](#)) cannot be adjusted.

Audyssey

■ Audyssey

See “**Audyssey**” in “**Source Setup**” (→ [page 45](#)).

■ Dynamic EQ

See “**Dynamic EQ**” in “**Source Setup**” (→ [page 45](#)).

■ Dynamic Volume

See “**Dynamic Volume**” in “**Source Setup**” (→ [page 46](#)).

Note

- These technologies can be used when all the following conditions are met:
 - Room Correction and Speaker Setup is completed. Note that “**Audyssey**” requires the “**Audyssey 2EQ Full Calibration**” method.
 - Any listening mode other than Direct is selected.
 - A pair of headphones is not connected.
- The setting is stored individually for each input selector.

Late Night

■ Late Night

For **Dolby Digital** and **Dolby Digital Plus** sources, the options are:

- ▶ **Off**
- ▶ **Low:**
Small reduction in dynamic range.
- ▶ **High:**
Large reduction in dynamic range.

For **Dolby TrueHD** sources, the options are:

- ▶ **Auto:**
The Late Night function is set to “**On**” or “**Off**” automatically.
- ▶ **Off**
- ▶ **On**

Turn this setting on to reduce the dynamic range of Dolby Digital material so that you can still hear quiet parts even when listening at low volume levels—ideal for watching movies late at night when you don’t want to disturb anyone.

Note

- The effect of the Late Night function depends on the material that you are playing and the intention of the original sound designer, and with some material there will be little or no effect when you select the different options.
- The Late Night function can be used only when the input source is Dolby Digital, Dolby Digital Plus, or Dolby TrueHD.
- The Late Night function is set to “**Off**” when the AV receiver is set to standby. For Dolby TrueHD sources, it will be set to “**Auto**”.

Music Optimizer

■ Music Optimizer

- ▶ **Off**
- ▶ **On**

Turn this setting on to enhance the sound quality of compressed music files. Use it with music files that use “lossy” compression, such as MP3.

Tip

- Alternatively, you can use the AV receiver’s **MUSIC OPTIMIZER**.

Note

- The Music Optimizer function only works with PCM digital audio input signals with a sampling rate below 48 kHz and analog audio input signals. The Music Optimizer is disabled when the Direct listening mode is selected.
- The setting is stored individually for each input selector.
- The **M.Opt** indicator will light (→ [page 8](#)).
- The **MUSIC OPTIMIZER** indicator lights on the front panel (→ [page 7](#)).

CinemaFILTER

■ Cinema Filter

- ▶ **Off**
- ▶ **On**

Turn this setting on to soften overly bright movie soundtracks, which are typically mixed for reproduction in a movie theater.

Cinema Filter can be used with the following listening modes: Dolby Digital, Dolby Digital EX, Dolby Digital Plus, TrueHD, Dolby Pro Logic IIx Movie, Dolby Pro Logic II Movie, Dolby Pro Logic IIz Height, Multichannel, DTS, DTS-ES, DTS Neo:6 Cinema, DTS 96/24, Neo:6, DTS-HD High Resolution, DTS-HD Master and DTS Express.

Note

- The Cinema Filter may not work when used with certain input sources.

Zone 2

In addition to the main listening room, you can also enjoy playback in another room, which we call Zone 2. For either of the rooms, you can specify a different input source.

Making Zone 2 Connections

There are two ways you can connect Zone 2 speakers:

1. Connect them directly to the AV receiver.
2. Connect them to an amp in Zone 2.

Connecting Your Zone 2 Speakers Directly to the AV receiver

This setup allows 5.1-channel playback in your main room and 2-channel stereo playback in Zone 2, with a different source in each room. This is called Powered Zone 2, as the Zone 2 speakers are powered by the AV receiver.

To use this setup, you must set the “Powered Zone 2” setting to “Yes” (→ page 42).

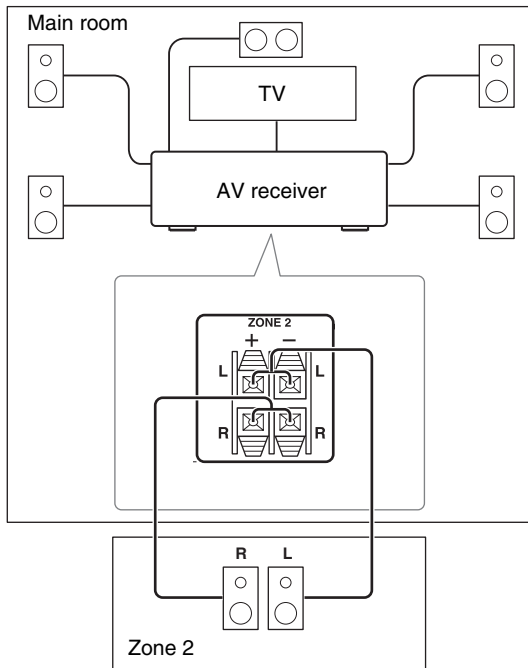

Note

- With this setup, the volume of Zone 2 is controlled by the AV receiver.
- When the “Powered Zone 2” setting is set to “Yes”, listening modes that require front high or surround back speakers are unavailable.

Connecting the Zone Speakers to an Additional Amplifier

This setup allows 7.1-channel playback in your main listening room and 2-channel stereo playback in Zone 2.

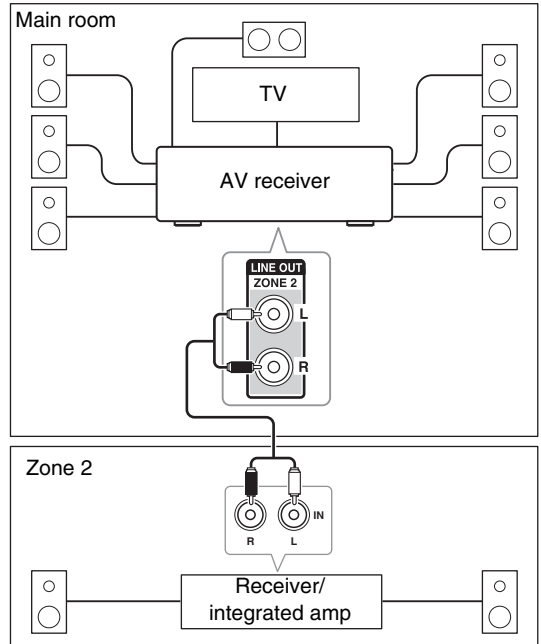

Note

- The volume of Zone 2 must be set on the Zone 2 amp.

Controlling Zone 2 Components

■ Operating on the AV receiver

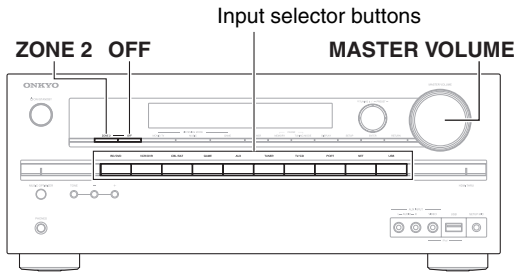

- 1 To turn on Zone 2 and select an input source, press ZONE 2 followed by an input selector button within 8 seconds.**

Zone 2 turns on, the **Z2** indicator lights on the display.

To select AM or FM, press the **TUNER** input selector button repeatedly.

To select the same source as the main room's, press **ZONE 2** repeatedly until "**Z2 Selector: Source**" appears on the display.

To turn off Zone 2, press OFF.

The zone is turned off.

■ Operating on the remote controller

To control Zone 2, you must press **ZONE2** on the remote controller first.

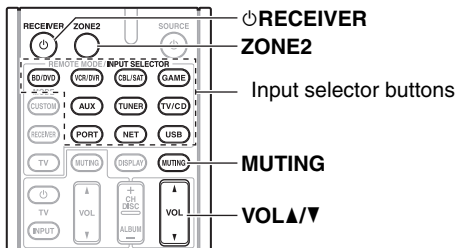

- 1 Press ZONE2 and then press RECEIVER.**

Zone 2 turns on, the **Z2** indicator lights on the display.

- 2 To select an input source for Zone 2, press ZONE2, followed by an input selector button.**

To select AM or FM, press the **TUNER** input selector button repeatedly.

Note

- You cannot select different AM or FM radio stations for your main room and Zone 2. The same AM/FM radio station will be heard in each room.

- 3 To turn off Zone 2, press ZONE2 followed by RECEIVER.**

Adjusting the Volume for Zone 2

■ Operating on the remote controller

- 1 Press ZONE2.**
- 2 Use VOL ▲/▼ to adjust the volume.**

■ Operating on the AV receiver

- 1 Press ZONE 2 (the Z2 indicator on the display flash).**
- 2 Use MASTER VOLUME control within 8 seconds to adjust the volume.**

If your Zone 2 speakers are connected to a receiver or integrated amp in Zone 2, use its volume control to adjust the volume.

Muting Zone 2

■ Operating on the remote controller

- 1 Press ZONE2 followed by MUTING.**

Tip

- To unmute, press **ZONE2** followed by **MUTING** again.

Note

- Only analog input sources are output from the **ZONE 2 LINE OUT L/R** jacks and **ZONE 2 L/R** terminals. Digital input sources are not output. If no sound is heard when an input source is selected, verify that the source is connected to an analog input.
- While Zone 2 is on, **RI** functions will not work.
- You cannot select different AM or FM radio stations for your main room and Zone 2. The same AM/FM radio station will be heard in each room. Namely, if you have selected an FM station for the main room, that station will also be output in Zone 2.
- When you have selected **NET** or **USB** as the input selector, the last selector selected will be set for both Main room and Zone 2.
- Zone 2 can also be unmuted by adjusting the volume.
- When Zone 2 is activated and its input selector is selected, the power consumption of standby mode slightly increases.
- When setting the AV receiver to standby mode while Zone 2 is active, the **Z2** indicator is dimly lit.

iPod/iPhone Playback via Onkyo Dock

Using the Onkyo Dock

For the latest information on the Onkyo Dock components, see the Onkyo web site at: <http://www.onkyo.com>

Before using the Onkyo Dock components, update your iPod/iPhone with the latest software, available from the Apple web site.

For supported iPod/iPhone models, see the instruction manual of the Onkyo Dock.

UP-A1 Dock

With the UP-A1 Dock, you can easily play the music, photos, or movies stored on your Apple iPod/iPhone through the AV receiver and enjoy great sound.

You can use the AV receiver's remote controller to operate your iPod/iPhone.

■ System Function

The AV receiver may take several seconds to startup, so you might not hear the first few seconds of the first song.

Auto Power On

If you start iPod/iPhone playback while the AV receiver is on standby, the AV receiver will automatically turn on and select your iPod/iPhone as the input source.

Direct Change

If you start iPod/iPhone playback while listening to another input source, the AV receiver will automatically select your iPod/iPhone as the input source.

Using the AV receiver's Remote Controller

You can use the AV receiver's remote controller to control basic iPod/iPhone functions (→ **page 59**).

■ Operating Notes

- Functionality depends on your iPod/iPhone model and generation.
- Before selecting a different input source, stop your iPod/iPhone playback to prevent the AV receiver from selecting the iPod/iPhone input source by mistake.
- If any accessories are connected to your iPod/iPhone, the AV receiver may not be able to select the input source properly.
- When connecting the UP-A1 Dock to the radio tuner UP-HT1 with AUTO selected by the tuner's Mode Selector switch, you can switch the input source between UP-A1 Dock and the tuner, by pressing **PORT** repeatedly on the front panel.
- While your iPod/iPhone is in the UP-A1 Dock, its volume control has no effect. If you adjust your iPod/iPhone models volume control while it's in the UP-A1 Dock, make sure it's not set too high before you reconnect your headphones.
- The Auto Power On function will not work if you set your iPod/iPhone in the UP-A1 Dock while it is playing.
- When Zone 2 is turned on, you can't use Auto Power On and Direct Change functions.
- The "**Charge Mode**" setting must be set to "**On**" to enable the Auto Power On and Direct Change functions (→ **page 49**).

■ Using Your iPod/iPhone Alarm Clock

You can use the Alarm Clock function of your iPod/iPhone to automatically turn on your iPod/iPhone and the AV receiver at a specified time. The AV receiver's input source will automatically be set to the **PORT** selector.

Note

- To use this function, your iPod/iPhone must be in the UP-A1 Dock, and the UP-A1 Dock must be connected to the AV receiver.
- This function works only in Standard mode (→ **page 60**).
- When you use this function, be sure to set the AV receiver's volume control to a suitable level.
- When Zone 2 is turned on, you can't use this function.
- This function doesn't work when alarms sounds are set on your iPod/iPhone.
- The "**Charge Mode**" setting must be set to "**On**" to enable the Alarm Clock function (→ **page 49**).

■ Charging Your iPod/iPhone Battery

When the UP-A1 Dock with docked iPod/iPhone is connected to the AV receiver, the battery of your iPod/iPhone is charged. Charging occurs when AV receiver is set to on or standby.

You can specify how the power is fed to your iPod/iPhone when the AV receiver is in standby mode (→ **page 49**).

Note

- When the UP-A1 Dock with docked iPod/iPhone is connected, the power consumption on standby mode slightly increases.

■ Status Messages

If either of the following messages is not displayed on the AV receiver's display, check the connection to your iPod/iPhone.

• PORT Reading

The AV receiver is checking the connection with the dock.

• PORT Not Support

The AV receiver does not support the connected dock.

• PORT UP-A1

UP-A1 Dock is connected.

Note

- The AV receiver displays the message “UP-A1” for several seconds after recognizing the UP-A1.

RI Dock

With the RI Dock, you can easily play the music stored on your Apple iPod/iPhone through the AV receiver and enjoy great sound, and watch iPod/iPhone slideshows and videos on your TV. In addition, the onscreen display (OSD) allows you to view, navigate, and select your iPod/iPhone model's contents on your TV, and with the supplied remote controller, you can control your iPod/iPhone from the comfort of your sofa. You can even use the AV receiver's remote controller to operate your iPod/iPhone.

Note

- Enter the appropriate remote control code before using the AV receiver's remote controller for the first time (→ page 61).
- Connect the RI Dock to the AV receiver with an **RI** cable (→ page 18).
- Set the RI Dock's RI MODE switch to “HDD” or “HDD/DOCK”.
- Set the AV receiver's Input Display to “DOCK” (→ page 37).

■ System Function

System On

When you turn on the AV receiver, the RI Dock and iPod/iPhone turn on automatically. In addition, when RI Dock and iPod/iPhone are on, the AV receiver can be turned on by pressing **SOURCE**.

Auto Power On

If you press the remote controller's **▶** (Playback) while the AV receiver is on standby, the AV receiver will automatically turn on, select your iPod/iPhone as the input source, and your iPod/iPhone will start playback.

Direct Change

If you start iPod/iPhone playback while listening to another input source, the AV receiver will automatically switch to the input to which the RI Dock is connected.

Other Remote Controllers

You can use the remote controller that came with the AV receiver to control other iPod/iPhone functions. The available functionality depends on the AV receiver.

iPod/iPhone Alarm

If you use the Alarm function on your iPod/iPhone to start playback, the AV receiver will turn on at the specified time and select your iPod/iPhone as the input source automatically.

Note

- Linked operations do not work with video playback or when the alarm is set to play a sound.
- If you use your iPod/iPhone with any other accessories, iPod/iPhone playback detection may not work.
- This function works only in Standard mode (→ page 60).
- The System On function may not work depending on the RI Dock.

■ Operating Notes

- Use the AV receiver's volume control to adjust the playback volume.
- While your iPod/iPhone is inserted in the RI Dock, its volume control has no effect.
- If you do adjust the volume control on your iPod/iPhone while it's inserted in the RI Dock, be careful that it's not set too loud before you reconnect your headphones.

Note

- On the iPod with video and iPod nano (1st generation), the click wheel is disabled during playback.

Controlling Your iPod/iPhone

By pressing the **REMOTE MODE** that's been programmed with the remote control code for your Dock, you can control your iPod/iPhone in the Dock with the buttons described further in this section.

See “Entering Remote Control Codes” for details on entering a remote control code (→ page 61).

See the Dock's instruction manual for more information.

UP-A1 Dock

PORT is preprogrammed with the remote control code for controlling a Dock via Universal Port.

You can control your iPod/iPhone when “**PORT**” is selected as the input source.

RI Dock

- Set the RI Dock's RI MODE switch to “HDD” or “HDD/DOCK”.
- **SOURCE** may not work with a remote control code (without **RI**). In this case, make an **RI** connection and enter the remote control code **81993** (with **RI**).

■ With the RI Control

Make an **RI** connection and enter the remote control code **81993** (with **RI**).

- Set the AV receiver's Input Display to “DOCK” (→ page 37).

■ Without the RI Control

You must enter the remote control code **82990** first (→ page 62).

✓: Available buttons

Press the appropriate **REMOTE MODE** first.

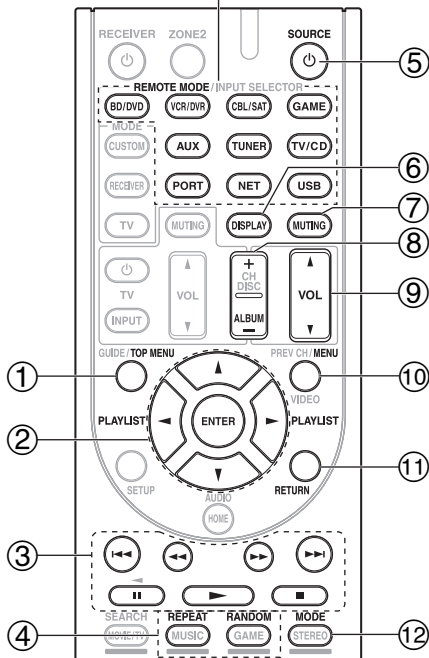

Onkyo Dock		UP-A1 Dock	RI Dock
Buttons			
①	TOP MENU *1		✓
②	▲/▼/◀/▶, ENTER	✓*2	✓
	PLAYLIST ◀/▶	✓*3	✓
③	▶, , ■, ◀, ▶▶, ◀◀, ▶▶▶	✓	✓
④	REPEAT	✓	✓
	RANDOM	✓	✓
⑤	⏻SOURCE *4		✓
⑥	DISPLAY	✓*5	✓*6
⑦	MUTING	✓	✓
⑧	ALBUM +/-	✓*3	✓
⑨	VOL ▲/▼	✓	✓
⑩	MENU		✓
⑪	RETURN	✓	
⑫	MODE	✓*7	✓*8

- With some iPod/iPhone models, generations and RI Docks, certain buttons may not work as expected.
- For detailed operation of iPod/iPhone, please refer to the instruction manual of the RI Dock.
- *1 **TOP MENU** works as the mode button when used with the DS-A2 RI Dock.
- *2 In Extended mode (see *7), **◀/▶** is used as the page jump button.
This allows you to quickly locate your favorite songs even when such lists as the song or artist lists are very long.
- *3 In Extended mode (see *7), this button doesn't work.
- *4 This button does not turn the Onkyo DS-A2 or DS-A2X RI Dock on or off. Also, your iPod/iPhone may not respond the first time you press this button, in which case you should press it again. This is because the remote controller transmits the On and Standby commands alternately, so if your iPod/iPhone is already on, it will remain on when the remote controller transmits the On command. Similarly, if your iPod/iPhone is already off, it will remain off when the remote controller transmits the Off command.
- *5 In Extended mode (see *7), **DISPLAY** is used to switch between song informations. In Standard mode (see *7), **DISPLAY** turns on backlight for a second.
- *6 **DISPLAY** turns on backlight for a second.
- *7 Press **MODE** to switch between the following modes:
Standard mode
 Nothing is displayed on your TV. Contents are browsed and selected on your iPod/iPhone display.
Extended mode (Music)
 The music contents (artists, albums, songs, and so on) are displayed on your TV, and you can browse and select them on screen.
Extended mode (Video)
 The video contents (Movies, Music Videos, TV Shows, Video Podcasts or Rentals) are displayed on your TV, and you can browse and select them on screen.
- *8 **Resume mode**
 With the Resume function, you can resume playback of the song that was playing when you removed your iPod/iPhone from the RI Dock.

Note

- In Extended mode (see *7), you cannot operate your iPod/iPhone directly.
- In Extended mode (see *7), it may take some time to acquire the contents.
- In Extended mode (see *7), the on-screen navigation menus only appear on a TV that is connected to the HDMI output.

Controlling Other Components

You can use the AV receiver's remote controller to control your other AV components, including those made by other manufacturers. This section explains how to enter the remote control code for a component that you want to control: DVD, TV, CD, etc.

Preprogrammed Remote Control Codes

The following **REMOTE MODE** buttons are preprogrammed with remote control codes for controlling the components listed. You do not need to enter a remote control code to control these components.

For details on controlling these components, see the indicated pages.

BD/DVD Onkyo Blu-ray Disc player (→ **page 62**)

TV/CD Onkyo CD player (→ **page 62**)

PORT Onkyo Universal Port Option (→ **page 59**)

Looking up for Remote Control Code

You can look up for an appropriate remote control code from the on-screen setup menu.

Note

- This can only be carried out using the on-screen setup menu.

1 Press **RECEIVER** followed by **SETUP**.

The main menu appears on-screen.

Tip

- If the main menu doesn't appear, make sure the appropriate external input is selected on your TV.

2 Use **▲/▼** to select “Remote Controller Setup”, and then press **ENTER**.

3 Use **▲/▼** to select “Remote Mode Setup”, and then press **ENTER**.

4 Use **▲/▼** to select a remote mode, and then press **ENTER**.

The menu of category selection appears.

5 Use **▲/▼** to select a category, and then press **ENTER**.

The panel for brand name input appears.

6 Use **▲/▼/◀/▶** to select a character, and then press **ENTER**.

Repeat this step for the first three characters of the brand name.

When you have entered the 3rd character, select “Search” and press **ENTER**.

A list of brand names is retrieved.

If the desired brand name is not found:

Use **▶** to select “Not Listed”, and then press **ENTER**.

The panel for brand name input appears.

7 Use **▲/▼** to select a brand, and then press **ENTER**.

A remote control code with its instructions are displayed. Follow the procedure.

8 If you can control the component, use **▲/▼** to select “OK”, and then press **ENTER**.

The “Remote Mode Setup” menu appears.

If you cannot control the component, use **▲/▼ to select “Try next code” and press **ENTER**.**

The next code is displayed.

Entering Remote Control Codes

You'll need to enter a code for each component that you want to control.

1 Look up the appropriate remote control code in the separate Remote Control Codes list.

The codes are organized by category (e.g., DVD player, TV, etc.).

2 While holding down the **REMOTE MODE** to which you want to assign a code, press and hold down **DISPLAY** (about 3 seconds).

The remote indicator lights.

Note

- Remote control codes cannot be entered for **RECEIVER** and **ZONE 2**.
- Only TV remote control codes can be entered for **TV**.
- Except for **RECEIVER**, **TV** and **ZONE 2**, remote control codes from any category can be assigned to the **REMOTE MODE**. However, these buttons also work as input selector buttons (→ **page 21**), so choose a **REMOTE MODE** that corresponds with the input to which you connect your component. For example, if you connect your CD player to the CD input, choose **TV/CD** when entering its remote control code.

3 Within 30 seconds, use the number buttons to enter the 5-digit remote control code.

The remote indicator flashes twice.

If the remote control code is not entered successfully, the remote indicator will flash once slowly.

Note

- Though the provided remote control codes are correct at the time of printing, they are subject to change.

Remote Control Codes for Onkyo Components Connected via RI

Onkyo components that are connected via **RI** are controlled by pointing the remote controller at the AV receiver, not the component. This allows you to control components that are out of view, in a rack, for example.

- 1 Make sure the Onkyo component is connected with an RI cable and an analog audio cable (RCA).**
See “Connecting Onkyo **RI** Components” for details (→ page 18).
- 2 Enter the appropriate remote control code for REMOTE MODE, referring to the previous section.**
 - ▶ **42157:**
Onkyo cassette tape deck with **RI**
 - ▶ **81993:**
Onkyo Dock with **RI**
- 3 Press REMOTE MODE, point the remote controller at the AV receiver, and operate the component.**

Controlling Onkyo components without RI

If you want to control an Onkyo component by pointing the remote controller directly at it, or you want to control an Onkyo component that’s not connected via **RI**, use the following remote control codes:

- ▶ **30627:**
Onkyo DVD player without **RI**
- ▶ **71817:**
Onkyo CD player without **RI**
- ▶ **32900/33100/33500:**
Onkyo Blu-ray Disc player
- ▶ **32901/33104/33504:**
Onkyo HD DVD player
- ▶ **70868:**
Onkyo MD recorder without **RI**
- ▶ **71323:**
Onkyo CD recorder without **RI**
- ▶ **82990:**
Onkyo Dock without **RI**

Resetting REMOTE MODE Buttons

You can reset a **REMOTE MODE** to its default remote control code.

- 1 While holding down REMOTE MODE that you want to reset, press and hold down HOME until the remote indicator lights (about 3 seconds).**
- 2 Within 30 seconds, press REMOTE MODE again.**
The remote indicator flashes twice, indicating that the button has been reset.
Each of **REMOTE MODE** is preprogrammed with a remote control code. When a button is reset, its preprogrammed code is restored.

Resetting the Remote Controller

You can reset the remote controller to its default settings.

- 1 While holding down RECEIVER, press and hold down HOME until the remote indicator lights (about 3 seconds).**
- 2 Within 30 seconds, press RECEIVER again.**
The remote indicator flashes twice, indicating that the remote controller has been reset.

Controlling Other Components

By pressing the **REMOTE MODE** that’s been programmed with the remote control code for your component, you can control your component as described below.

For details on entering a remote control code for other components, see “Entering Remote Control Codes” (→ page 61).

Controlling a TV

TV is preprogrammed with the remote control code for controlling a TV that supports the **RIHD***1 (limited to some models). The TV must be able to receive remote control commands via **RIHD** and be connected to the AV receiver via HDMI. If controlling your TV via **RIHD** doesn’t work very well, program your TV’s remote control code into **TV** and use the TV remote mode to control your TV.

Use the following remote control codes:

- ▶ **11807/13100/13500:**
TV with **RIHD**

Controlling a Blu-ray Disc/DVD Player, HD DVD Player or DVD Recorder

BD/DVD is preprogrammed with the remote control code for controlling a component that supports the **RIHD***1 (limited to some models). The component must be able to receive remote control commands via **RIHD** and be connected to the AV receiver via HDMI.

Use the following remote control codes:

- ▶ **32910/33101/33501/31612:**
Blu-ray Disc/DVD player with **RIHD**

*1 The **RIHD** supported by the AV receiver is the CEC system control function of the HDMI standard.

Press the appropriate **REMOTE MODE** first.

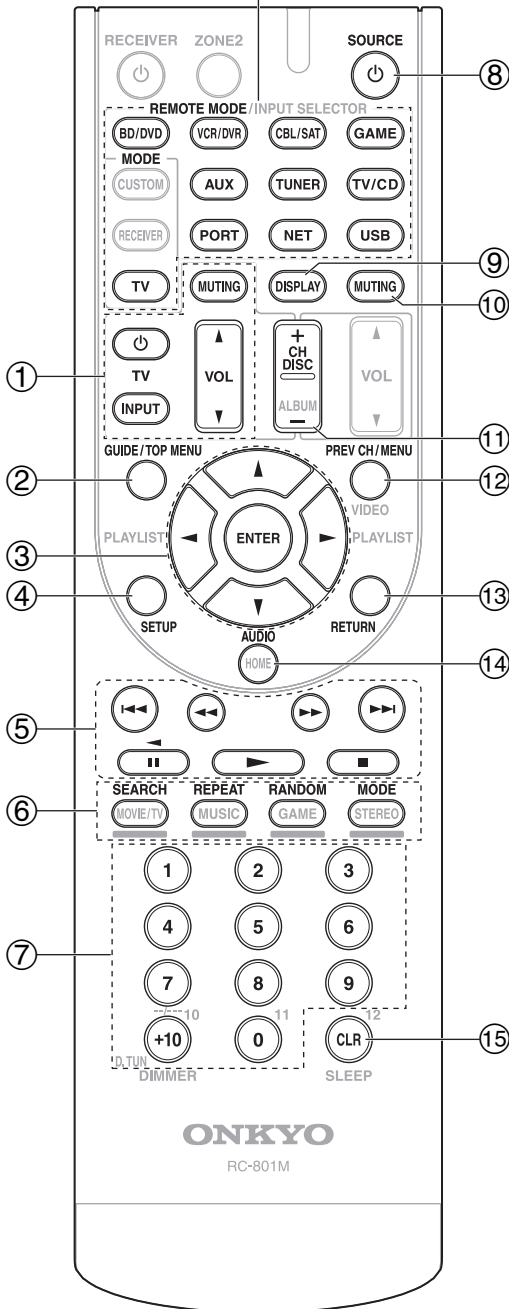

Buttons	Components						
	TV	DVD player/DVD recorder	Blu-ray Disc player HD DVD player	VCR/PVR	Satellite receiver Cable receiver	CD player/CD recorder MD recorder	Cassette tape deck
① ⏻, INPUT, TV VOL ▲/▼, MUTING	✓						
② GUIDE	✓			✓	✓		
TOP MENU		✓					
③ ▲/▼/◀/▶, ENTER	✓	✓		✓	✓	✓	
④ SETUP	✓	✓		✓	✓	✓	
⑤ ▶▶, , ■, ◀◀, ▶▶, ◀◀, ▶▶	✓ ^{*1}	✓		✓	✓	✓	✓ ^{*3}
⑥ SEARCH	✓ ^{*1*2}	✓ ^{*1}	✓ ^{*2}		✓ ^{*2}	✓	
REPEAT	✓ ^{*1*2}	✓	✓ ^{*2}		✓ ^{*2}	✓	
RANDOM	✓ ^{*1*2}	✓ ^{*1}	✓ ^{*2}		✓ ^{*2}	✓	
MODE	✓ ^{*1*2}	✓ ^{*1}	✓ ^{*2}		✓ ^{*2}	✓	
⑦ Number: 1 to 9, 0	✓	✓		✓	✓	✓	
Number: +10	✓ ^{*1}	✓ ^{*1}		✓	✓	✓	
⑧ ⏻SOURCE ^{*4}		✓		✓	✓	✓	✓
⑨ DISPLAY	✓	✓		✓	✓	✓	
⑩ MUTING		✓		✓	✓	✓	✓
⑪ CH +/-	✓	✓		✓	✓		
DISC +/-		✓				✓	
⑫ PREV CH	✓			✓	✓		
MENU		✓					
⑬ RETURN	✓			✓	✓		
⑭ AUDIO	✓ ^{*1}	✓ ^{*1}			✓		
⑮ CLR	✓	✓		✓	✓	✓	

- *1 The **RIHD** function is not supported. The **RIHD** supported by the AV receiver is the CEC system control function of the HDMI standard.
- *2 These buttons function as colored buttons or A, B, C, D buttons.
- *3 **||** (Pause) functions as reverse playback.
- *4 When you press **⏻SOURCE**, the related component is turned on (or off).

Note

- See the “Controlling Your iPod/iPhone” about the operation of iPod/iPhone (→ **page 59**).

Note

- With some components, certain buttons may not work as expected, and some may not work at all.

Troubleshooting

If you have any trouble using the AV receiver, look for a solution in this section. If you can't resolve the issue yourself, contact your Onkyo dealer.

If you can't resolve the issue yourself, try resetting the AV receiver before contacting your Onkyo dealer.

To reset the AV receiver to its factory defaults, turn it on and, while holding down VCR/DVR, press \odot ON/STANDBY. "Clear" will appear on the display and the AV receiver will enter standby mode.

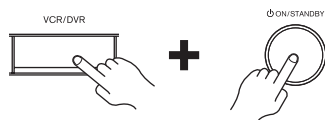

Note that resetting the AV receiver will delete your radio presets and custom settings.

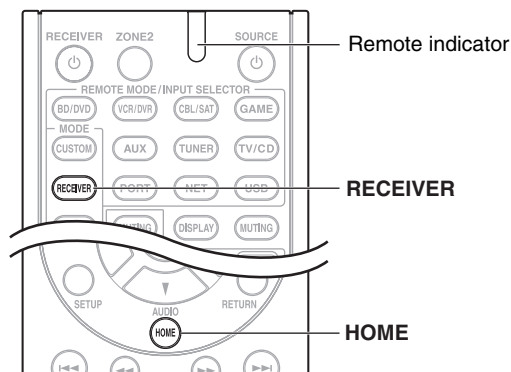

To reset the remote controller to its factory defaults, while holding down **RECEIVER**, press and hold down **HOME** until the remote indicator lights (about 3 seconds). Within 30 seconds, press **RECEIVER** again.

The on-screen setup menus appear only on a TV that is connected to the HDMI OUT. If your TV is connected to other video outputs, use the AV receiver's display when changing settings.

Power

■ Can't turn on the AV receiver

Make sure that the power cord is properly plugged into the wall outlet. —

Unplug the power cord from the wall outlet, wait five seconds or more, then plug it in again. —

■ The AV receiver turns off unexpectedly

The AV receiver will automatically enter standby mode when Auto Standby has been set and launches. **52**

■ When the power is restored after a power interruption, "CHECK SP WIRE" appears on the display

The protection circuit has been activated. Remove the power cord from the wall outlet immediately. Disconnect all speaker cables and input sources, and leave the AV receiver with its power cord disconnected for 1 hour. After that, reconnect the power cord and set the volume to maximum. If the AV receiver stays on, set the volume to minimum, disconnect the power cord, and reconnect your speakers and input sources. If the AV receiver turns off when you set the volume to maximum, disconnect the power cord, and contact your Onkyo dealer. —

Audio

■ There's no sound, or it's very quiet

Make sure that the digital input source is selected properly. **41**

Make sure that all audio connecting plugs are pushed in all the way. **14**

Make sure that the inputs and outputs of all components are connected properly. **15-18**

Make sure that the polarity of the speaker cables is correct, and that the bare wires are in contact with the metal part of each speaker terminal. **12**

Make sure that the input source is properly selected. **21**

Make sure that the speaker cables are not shorting. **12**

Check the volume. The AV receiver is designed for home theater enjoyment. It has a wide volume range, allowing precise adjustment. —

If the **MUTING** indicator is flashing on the display, press the remote controller's **MUTING** to unmute the AV receiver. **37**

While a pair of headphones is connected to the **PHONES** jack, no sound is output from the speakers. **38**

If there's no sound from a DVD player connected to an HDMI IN, check the DVD player's output settings, and be sure to select a supported audio format. —

Check the digital audio output setting on the connected device. On some game consoles, such as those that support DVD, the default setting is off. —

With some DVD-Video discs, you need to select an audio output format from a menu. —

If your turntable uses an MC cartridge, you must connect an MC head amp, or an MC transformer. —

Make sure that none of the connecting cables are bent, twisted, or damaged. —

Not all listening modes use all speakers. **32**

Specify the speaker distances and adjust the individual speaker levels. **43**

Make sure that the speaker setup microphone is not still connected. —

The input signal format is set to "PCM" or "DTS". Set it to "Off". **49**

■ Only the front speakers produce sound

When the Stereo or Mono listening mode is selected, only the front speakers and subwoofer produce sound.

Check the Speaker Configuration. **42**

■ Only the center speaker produces sound

If you use the Dolby Pro Logic IIx Movie, Dolby Pro Logic IIx Music, or Dolby Pro Logic IIx Game listening mode with a mono source, such as an AM radio station or mono TV program, the sound is concentrated in the center speaker.

Make sure the speakers are configured correctly. **42**

■ The surround speakers produce no sound

When the T-D (Theater-Dimensional), Stereo or Mono listening mode is selected, the surround speakers produce no sound.

Depending on the source and current listening mode, not much sound may be produced by the surround speakers. Try selecting another listening mode.

Make sure the speakers are configured correctly. **42**

■ The center speaker produces no sound

When the Stereo or Mono listening mode is selected, the center speaker produces no sound.

Make sure the speakers are configured correctly. **42**

■ The front high and surround back speakers produce no sound

Depending on the current listening mode, no sound may be produced by the front high and surround back speakers. Select another listening mode. **32**

Depending on the sources, the sound produced by the front high and surround back speakers may be weak.

Make sure the speakers are configured correctly. **42**

While the “Powered Zone 2” setting is set to “Yes”, playback in the main room is reduced to 5.1-channels and the front high and surround back speakers produce no sound. **56**

■ The subwoofer produces no sound

When you play a source material that contains no information in the LFE channel, the subwoofer produces no sound.

Make sure the speakers are configured correctly. **42**

■ There's no sound with a certain signal format

Check the digital audio output setting on the connected device. On some game consoles, such as those that support DVD, the default setting is off.

With some DVD-Video discs, you need to select an audio output format from a menu.

Depending on the input signal, some listening modes cannot be selected. **32-35**

■ Can't get 6.1/7.1 playback

If no surround back speakers and front high speakers are connected, or the Zone 2 speakers are being used, 6.1/7.1 playback is not possible.

Depending on the number of connected speakers, it is not always possible to select all of the listening modes. **32-35**

■ The speaker volume cannot be set as required

Check to see if a maximum volume has been set. **50**

If the volume level of each individual speaker has been adjusted to high positive values, then the maximum master volume possible may be reduced. Note that the individual speaker volume levels are set automatically after the Audyssey 2EQ® Room Correction and Speaker Setup has been performed. **28, 43**

■ Noise can be heard

Using cable ties to bundle audio cables with power cords, speaker cables, and the like may degrade the audio performance, so refrain from doing it.

An audio cable may be picking up interference. Try repositioning your cables.

■ The Late Night function doesn't work

Make sure the source material is Dolby Digital, Dolby Digital Plus, and Dolby TrueHD. **55**

■ About DTS signals

When DTS program material ends and the DTS bitstream stops, the AV receiver remains in DTS listening mode and the DTS indicator remains on. This is to prevent noise when you use the pause, fast forward, or fast reverse function on your player. If you switch your player from DTS to PCM, because the AV receiver does not switch formats immediately, you may not hear any sound, in which case you should stop your player for about three seconds, and then resume playback.

With some CD and LD players, you won't be able to playback DTS material properly even though your player is connected to a digital input on the AV receiver. This is usually because the DTS bitstream has been processed (e.g., output level, sampling rate, or frequency response changed) and the AV receiver doesn't recognize it as a genuine DTS signal. In such cases, you may hear noise.

Playing DTS program material, using the pause, fast forward, or fast reverse function on your player may produce a short audible noise. This is not a malfunction.

■ The beginning of audio received by an HDMI IN can't be heard

Since it takes longer to identify the format of an HDMI signal than it does for other digital audio signals, audio output may not start immediately.

Video

There's no picture

Make sure that all video connecting plugs are pushed in all the way. **14**

Make sure that each video component is properly connected. **15, 16**

If your TV is connected to the **HDMI OUT**, select “- - - -” in the “**HDMI Input**” setup to watch composite video, and component video sources. **40**

If the video source is connected to a component video input, you must assign that input to an input selector, and your TV must be connected to either the **HDMI OUT** or **COMPONENT VIDEO OUT**. **16, 40**

If the video source is connected to a composite video input, your TV must be connected to the **HDMI OUT** or the corresponding composite video output. **16**

If the video source is connected to an HDMI input, you must assign that input to an input selector, and your TV must be connected to the HDMI OUT. **15, 40**

On your TV, make sure that the video input to which the AV receiver is connected is selected. —

There's no picture from a source connected to an HDMI IN

Reliable operation with an HDMI-to-DVI adapter is not guaranteed. In addition, video signals from a PC are not guaranteed. **78**

When the resolution is set to any resolution not supported by the TV, no video is output from the HDMI outputs. **40**

If the message “**Resolution Error**” appears on the AV receiver's display, this indicates that your TV does not support the current video resolution and you need to select another resolution on your DVD player. —

The on-screen menus don't appear

On your TV, make sure that the video input to which the AV receiver is connected is selected. —

When the AV receiver is not connected to a TV via HDMI, onscreen menus are not displayed. —

The on screen display does not appear

Depending on the input signal, the on screen display may not appear when the input signal from the **HDMI IN** is output to a device connected to the **HDMI OUT**. **50**

Tuner

Reception is noisy, FM stereo reception is noisy, or the FM STEREO indicator doesn't light

Relocate your antenna. —

Move the AV receiver away from your TV or computer. —

Listen to the station in mono. **26**

When listening to an AM station, operating the remote controller may cause noise. —

Passing cars and airplanes can cause interference. —

Concrete walls weaken radio signals. —

If nothing improves the reception, install an outdoor antenna. —

Remote Controller

The remote controller doesn't work

Before operating this unit, be sure to press **RECEIVER**. —

Make sure that the batteries are installed with the correct polarity. **4**

Install new batteries. Don't mix different types of batteries, or old and new batteries. **4**

Make sure that the remote controller is not too far away from the AV receiver, and that there's no obstruction between the remote controller and the AV receiver's remote control sensor. **4**

Make sure that the AV receiver is not subjected to direct sunshine or inverter-type fluorescent lights. Relocate if necessary. —

If the AV receiver is installed in a rack or cabinet with colored-glass doors, the remote controller may not work reliably when the doors are closed. —

Make sure you've selected the correct remote controller mode. **10, 62**

When using the remote controller to control other manufacturers' AV components, some buttons may not work as expected. —

Make sure you've entered the correct remote control code. **61**

Make sure to set the same ID on both the AV receiver and remote controller. **51**

Can't control other components

If it's an Onkyo component, make sure that the **RI** cable and analog audio cable are connected properly. Connecting only an **RI** cable won't be enough. **18**

Make sure you've selected the correct remote controller mode. **10, 62**

For a proper operation of the remote controller as a cassette tape deck is connected to the **TV/CD IN** jack, or as an **RI Dock** is connected to the **TV/CD IN**, **VCR/DVR IN** or **GAME IN** jacks, you must set the input display accordingly. **37**

If you cannot operate it, you will need to enter the appropriate remote control code. **61**

To control another manufacturer's component, point the remote controller at that component. **61**

To control an Onkyo component that's connected via **RI**, point the remote controller at the AV receiver. Be sure to enter the appropriate remote control code first. **61**

To control an Onkyo component that's not connected via **RI**, point the remote controller at the component. Be sure to enter the appropriate remote control code first. **62**

The entered remote control code may not be correct. —
If more than one code is listed, try each one.

UP-A1 Dock for iPod/iPhone

There's no sound

Make sure your iPod/iPhone is actually playing. —

Make sure your iPod/iPhone is properly inserted in the Dock. —

Make sure the UP-A1 Dock is connected to the **UNIVERSAL PORT** jack on the AV receiver. —

Make sure the AV receiver is turned on, the correct input source is selected, and the volume is turned up. —

Make sure the plugs are pushed in all the way. —

Try resetting your iPod/iPhone. —

There's no video

Make sure that your iPod/iPhone model's TV OUT setting is set to On. —

Make sure the correct input is selected on your TV or the AV receiver. —

Some versions of the iPod/iPhone do not output video. —

The AV receiver's remote controller doesn't control my iPod/iPhone

Make sure your iPod/iPhone is properly inserted in the Dock. If your iPod/iPhone is in a case, it may not connect properly to the Dock. Always remove your iPod/iPhone from the case before inserting it into the Dock. —

The iPod/iPhone cannot be operated while it's displaying the Apple logo. —

Make sure you've selected the right remote mode. **21**

When you use the AV receiver's remote controller, point it toward your AV receiver. —

When connecting the UP-A1 Dock to the radio tuner UP-HT1 with AUTO selected with the tuner's Mode Selector switch, you can switch the input source between the UP-A1 Dock and the tuner, by pressing **PORT** repeatedly on the front panel. —

If you still can't control your iPod/iPhone, start playback by pressing your iPod/iPhone model's Play button. Remote operation should then be possible. —

Try resetting your iPod/iPhone. —

Depending on your iPod/iPhone, some buttons may not work as expected. —

The AV receiver unexpectedly selects your iPod/iPhone as the input source

Always pause iPod/iPhone playback before selecting a different input source. If playback is not paused, the Direct Change function may select your iPod/iPhone as the input source by mistake during the transition between tracks. —

Recording

Can't record

On your recorder, make sure the correct input is selected. —

To prevent signal loops and damage to the AV receiver, input signals are not fed through to outputs with the same name (**VCR/DVR IN** to **VCR/DVR OUT**). —

Zone 2

There's no sound

Only components connected to analog inputs can be played in Zone 2. —

The Zone 2 speakers produce no sound

Zone 2 speakers can be used when the "Powered Zone 2" setting is set to "Yes". **42**

Music Server and Internet Radio

Can't access the server or Internet radio

Check the network connection between the AV receiver and your router or switch. —

Make sure that your modem and router are properly connected, and make sure they are both turned on. —

Make sure the server is up and running and compatible with the AV receiver. **70, 72**

Check the "Network" settings. **53**

Playback stops while listening to music files on the server

Make sure your server is compatible with the AV receiver. **70, 72**

If you download or copy large files on your computer, playback may be interrupted. Try closing any unused programs, use a more powerful computer, or use a dedicated server. —

If the server is serving large music files to several networked devices simultaneously, the network may become overloaded and playback may be interrupted. Reduce the number of playback devices on the network, upgrade your network, or use a switch instead of a hub. —

Can't connect to the AV receiver from a Web browser

If you're using DHCP, your router may not always allocate the same IP address to the AV receiver, so if you find that you can't connect to a server or Internet radio station, recheck the AV receiver's IP address on the "Network" screen. **53**

Check the "Network" settings. **53**

USB Device Playback

■ Can't access the music files on a USB device

Make sure the USB device is plugged in properly. —

The AV receiver supports USB devices that support the USB mass storage device class. However, playback may not be possible with some USB devices even if they conform to the USB mass storage device class. —

USB memory devices with security functions cannot be played. —

Others

■ Standby power consumption

In the following cases, the power consumption in standby mode may reach up to a maximum of 37 W: **16, 51, 52, 53**

- You are using the Universal Port jack.
- “**Network Control**” is set to “**Enable**” in the “**Network**” setting.
- “**HDMI Control (RIHD)**” setting is set to “**On**”. (Depending on the TV status, the AV receiver will enter standby mode as usual.)
- The “**HDMI Through**” setting is set to other than “**Off**”.

■ The sound changes when I connect my headphones

When a pair of headphones is connected, the listening mode is set to Stereo, unless it's already set to Stereo, Mono or Direct. —

■ The speaker distance cannot be set as required

In some cases, corrected values suitable for home theater use may be set automatically. —

■ How do I change the language of a multiplex source

Use the “**Multiplex**” setting on the “**Audio Adjust**” **44** menu to select “**Main**” or “**Sub**”.

■ The RI functions don't work

To use **RI**, you must make an **RI** connection and an analog audio connection (RCA) between the component and AV receiver, even if they are connected digitally. **18**

■ The functions System On/Auto Power On and Direct Change don't work for components connected via RI

These functions don't work when Zone 2 is turned on. **18**

■ When performing “Automatic Speaker Setup”, the measurement fails showing the message “Ambient noise is too high.”

This can be caused by a malfunction in your speaker unit. Check if the unit produces normal sounds. —

■ The following settings can be made for the composite video inputs

You must use the buttons on the unit to make these settings.

On the AV receiver, press the input selector for the input source that you want to set and the **SETUP** button simultaneously. While holding down the input selector button, press **SETUP** until “**Video ATT:On**” appears on the display. Then, release both buttons. To reactivate the setting, repeat the above process so that “**Video ATT:Off**” appears on the display, and release the buttons.

• Video Attenuation

This setting can be made for the **BD/DVD**, **VCR/DVR**, **CBL/SAT**, **GAME** or **AUX** input.

If you have a game console connected to the composite video input, and the picture isn't very clear, you can attenuate the gain.

Video ATT:Off: (default).

Video ATT:On: Gain is reduced by 2 dB.

■ If the picture on your TV/monitor connected to HDMI OUT is unstable, try switching the DeepColor function off

To turn off the DeepColor function, simultaneously press the **CBL/SAT** and **ON/STANDBY** buttons on the AV receiver. While holding down **CBL/SAT**, press **ON/STANDBY** until “**Off**” appears on the display. Then, release both buttons. To reactivate the DeepColor function, repeat the above process until “**On**” appears on the display and release the buttons.

The AV receiver contains a microcomputer for signal processing and control functions. In very rare situations, severe interference, noise from an external source, or static electricity may cause it to lockup. In the unlikely event that this happens, unplug the power cord from the wall outlet, wait at least five seconds, and then plug it back in.

Onkyo is not responsible for damages (such as CD rental fees) due to unsuccessful recordings caused by the unit's malfunction. Before you record important data, make sure that the material will be recorded correctly.

Before disconnecting the power cord from the wall outlet, set the AV receiver to standby.

Important Note Regarding Video Playback

The AV receiver can upconvert component video and composite video sources for display on a TV connected to the **HDMI OUT**. However, if the picture quality of the source is poor, upconversion may make the picture worse or disappear altogether.

In this case, try the following:

1 If the video source is connected to a component video input, connect your TV to the COMPONENT VIDEO OUT.

If the video source is connected to a composite video input, connect your TV to the **MONITOR OUT V**.

2 On the main menu, select “Input/Output Assign”, and then select “Component Video Input” (→ page 41).

If the video source is connected to **COMPONENT VIDEO IN 1**, select the relevant input selector, and assign it to “**IN1**”.

If the video source is connected to **COMPONENT VIDEO IN 2**, select the relevant input selector, and assign it to “**IN2**”.

If the video source is connected to a composite video input, select the relevant input selector, and assign it to “**- - - -**”.

Network/USB Features

Connecting to the Network

The following diagram shows how you can connect the AV receiver to your home network. In this example, it's connected to a LAN port on a router, which has a 4-port 100Base-TX switch built-in.

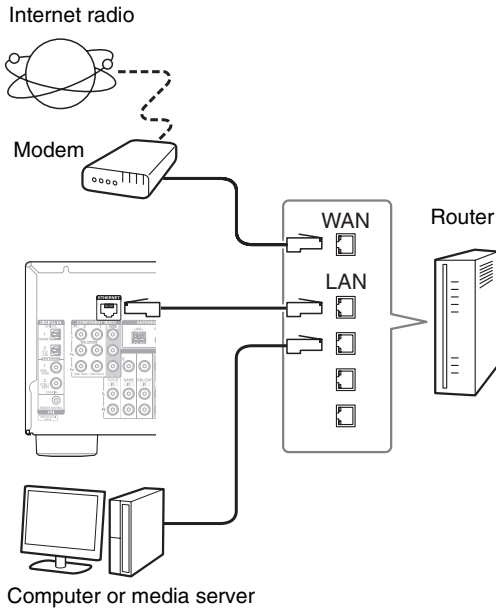

Network Requirements

■ Ethernet Network

For the best results, a 100Base-TX switched Ethernet network is recommended. Although it's possible to play music on a computer that's connected to the network wirelessly, playback may be unreliable, so it is recommended to use wired connections.

■ Ethernet Router

A router manages the network, data-routing and supplying of IP addresses. Your router must support the following:

- NAT (Network Address Translation). NAT allows several networked computers to access the Internet simultaneously via a single Internet connection. The AV receiver needs Internet access for Internet radio.
- DHCP (Dynamic Host Configuration Protocol). DHCP supplies IP addresses to the network devices, allowing them to configure themselves automatically.
- A router with a built-in 100Base-TX switch is recommended.

Some routers have a built-in modem, and some ISPs require you to use specific routers. Please consult your ISP or computer dealer if you're unsure.

■ CAT5 Ethernet cable

Use a shielded CAT5 Ethernet cable (straight-type) to connect the AV receiver to your home network.

■ Internet Access (for Internet radio)

To receive Internet radio, your Ethernet network must have Internet access. A narrowband Internet connection (e.g., 56K modem, ISDN) will not provide satisfactory results, so a broadband connection is strongly recommended (e.g., cable modem, xDSL modem, etc). Please consult your ISP or computer dealer if you're unsure.

Note

- To receive Internet radio with the AV receiver, your broadband Internet connection must be working and able to access the Web. Consult your ISP if you have any problems with your Internet connection.
- The AV receiver uses DHCP to configure its network settings automatically. If you want to configure these settings manually, see "Network" (→ **page 53**).
- The AV receiver does not support PPPoE settings, so if you have a PPPoE-type Internet connection, you must use a PPPoE-compatible router.
- Depending on your ISP, you may need to specify a proxy server to use Internet radio. If your computer is configured to use a proxy server, use the same settings for the AV receiver (→ **page 53**).

Server Requirements

■ Server playback

The AV receiver can play digital music files stored on a computer or media server and supports the following technologies:

- Windows Media Player 11
- Windows Media Player 12
- Windows Media Connect 2.0
- DLNA-certified media server

If the operating system of your computer is Windows Vista, Windows Media Player 11 is already installed. Windows Media Player 11 for Windows XP can be downloaded for free from the Microsoft web site.

- The computer or media server must be on the same network as the AV receiver.
- Each folder may contain up to 20000 music files, and folders may be nested up to 16 levels deep.

Note

- Depending on the media server, the AV receiver may not recognize it, or may not be able to play its music files.

Minimum system requirements for Windows Media Player 11 on Windows XP

Operating system

Windows XP Home Edition (SP2), Windows XP Professional (SP2), Windows XP Tablet PC Edition (SP2), Update Rollup 2 for Windows XP Media Center Edition 2005 (KB900325), October 2006 Update Rollup for Windows XP Media Center Edition (KB925766)

Processor: 233 MHz Intel Pentium II, Advanced Micro Devices (AMD), etc.

Memory: 64 MB

Hard disk: 200 MB of free space

Drive: CD or DVD drive

Modem: 28.8 kbps

Sound card: 16-bit sound card

Monitor: Super VGA (800 x 600)

Video card: 64 MB VRAM, DirectX 9.0b

Software: Microsoft ActiveSync (only when using a Windows Mobile-based Pocket PC or smartphone)

Web browser: Microsoft Internet Explorer 6 or Netscape 7.1

■ Remote playback

- Windows Media Player 12
- DLNA-certified (within DLNA Interoperability Guidelines version 1.5) media server or controller device.

Setting varies depending on the device. Refer to your device's instruction manual for details.

If the operating system of your personal computer is Windows 7, Windows Media Player 12 is already installed. For more information, see the Microsoft web site.

USB Device Requirements

- USB mass storage device class (but not always guaranteed).
- FAT16 or FAT32 file system format.
- If the storage device has been partitioned, each section will be treated as an independent device.
- Each folder may contain up to 20,000 music files and folders, and folders may be nested up to 16 levels deep.
- USB hubs and USB devices with hub functions are not supported.

Note

- If the media you connect is not supported, the message “**No Storage**” will appear on the display.
- If you connect a USB hard disk drive to the AV receiver's **USB** port, we recommend that you use its AC adapter to power it.
- The AV receiver supports USB MP3 players that support the USB Mass Storage Class standard, which allows USB devices to be connected to computers without the need for special drivers or software. Note that not all USB MP3 players support the USB Mass Storage Class standard. Refer to your USB MP3 player's instruction manual for details.
- Protected WMA music files on an MP3 player cannot be played.
- Onkyo accepts no responsibility whatsoever for the loss or damage to data stored on a USB device when that device is used with the AV receiver. We recommend that you back up your important music files beforehand.
- MP3 players containing music files that are managed with special music software are not supported.
- Operation is not guaranteed for all USB devices, which includes the ability to power them.
- Do not connect your USB device via a USB hub. The USB device must be connected directly to the AV receiver's **USB** port.
- If the USB device contains a lot of data, the AV receiver may take a while to read it.
- USB devices with security functions cannot be played.

Supported Audio File Formats

For server playback and playback from a USB device, the AV receiver supports the following music file formats. Variable bit-rate (VBR) files are supported. However, playback time may not be display correctly.

Note

- With remote playback, the AV receiver does not support the following music file formats: FLAC and Ogg Vorbis.
- In the case of server playback, the below-mentioned file formats may not be played depending on the server type.

■ MP3 (.mp3 or .MP3)

- MP3 files must be MPEG-1/MPEG-2 Audio Layer 3 format with a sampling rate of 8 kHz, 11.025 kHz, 12 kHz, 16 kHz, 22.05 kHz, 24 kHz, 32 kHz, 44.1 kHz, 48 kHz and bitrates of between 8 kbps and 320 kbps. Incompatible files cannot be played.

■ WMA (.wma or .WMA)

WMA stands for Windows Media Audio and is an audio compression technology developed by Microsoft Corporation. Audio can be encoded in WMA format by using Windows Media® Player.

- WMA files must have the copyright option turned off.
- Sampling rates of 8 kHz, 11.025 kHz, 12 kHz, 16 kHz, 22.05 kHz, 24 kHz, 32 kHz, 44.1 kHz, 48 kHz, bitrates of between 5 kbps and 320 kbps, and WMA DRM are supported.
- WMA Pro/Voice formats are not supported.

■ WMA Lossless (.wma or .WMA)

- Sampling rates of 44.1 kHz, 48 kHz, 88.2 kHz, 96 kHz are supported.
- Quantization bit: 16 bit, 24 bit

■ WAV (.wav or .WAV)

WAV files contain uncompressed PCM digital audio.

- Sampling rates of 8 kHz, 11.025 kHz, 12 kHz, 16 kHz, 22.05 kHz, 24 kHz, 32 kHz, 44.1 kHz, 48 kHz, 64 kHz, 88.2 kHz, and 96 kHz are supported.
- Quantization bit: 8 bit, 16 bit, 24 bit

■ AAC

(.aac/.m4a/.mp4/.3gp/.3g2/.AAC/.M4A/.MP4/.3GP or .3G2)

AAC stands for MPEG-2/MPEG-4 Audio.

- Sampling rates of 8 kHz, 11.025 kHz, 12 kHz, 16 kHz, 22.05 kHz, 24 kHz, 32 kHz, 44.1 kHz, 48 kHz, 64 kHz, 88.2 kHz, 96 kHz and bitrates of between 8 kbps and 320 kbps are supported.

■ FLAC (.flac or .FLAC)

FLAC is a file format for lossless audio data compression.

- Sampling rates of 8 kHz, 11.025 kHz, 12 kHz, 16 kHz, 22.05 kHz, 24 kHz, 32 kHz, 44.1 kHz, 48 kHz, 64 kHz, 88.2 kHz, and 96 kHz are supported.
- Quantization bit: 8 bit, 16 bit, 24 bit

■ Ogg Vorbis (.ogg or .OGG)

- Sampling rates of 8 kHz, 11.025 kHz, 12 kHz, 16 kHz, 22.05 kHz, 24 kHz, 32 kHz, 44.1 kHz, 48 kHz and bitrates of between 48 kbps and 500 kbps are supported. Incompatible files cannot be played.

■ LPCM (Linear PCM)

- Sampling rates of 8 kHz, 11.025 kHz, 12 kHz, 16 kHz, 22.05 kHz, 24 kHz, 32 kHz, 44.1 kHz, 48 kHz, 64 kHz, 88.2 kHz, and 96 kHz are supported.
- Quantization bit: 8 bit, 16 bit, 24 bit
- * Only for playback via network.

About DLNA

The Digital Living Network Alliance is an international, cross-industry collaboration. Members of DLNA develop a concept of wired and wireless interoperable networks where digital content such as photos, music, and videos can be shared through consumer electronics, personal computers, and mobile devices in and beyond the home. The AV receiver complies with the DLNA Interoperability Guidelines version 1.5.

Firmware Update

To update the firmware of the AV receiver, you can choose from the following two methods: update via network, or update via USB storage. Choose the one that best suits your environment. Before proceeding with the update, please read the corresponding explanations carefully.

■ Update via network

You need a wired Internet connection to update the firmware.

■ Update via USB storage (→ page 74)

Please prepare a USB storage device such as a USB flash memory stick. You need at least 32 MB of available space to update the firmware.

Note

- Check the network connection before updating.
- Do not touch the any cable or device connected to the AV receiver during the update process.
- Do not attempt to access the AV receiver from your PC while it is being updated.
- Do not shutdown the power of the AV receiver while it is being updated.
- The storage media in the USB card reader may not work.
- If the USB device is partitioned, each section will be treated as an independent device.
- If the USB device contains a lot of data, the AV receiver may take a while to read it.
- Operation is not guaranteed for all USB devices, which includes the ability to power them.
- Onkyo takes no responsibility whatsoever for the loss or damage of data resulting from the use of a USB device with the AV receiver. Onkyo recommends that you back up your important music files beforehand.
- If you connect a USB hard disk drive to the USB port, Onkyo recommends that you use its AC adapter to power it.
- USB hubs and USB devices with hub functions are not supported. Do not connect your USB device via a USB hub.
- USB devices with security functions are not supported.

Limitation of liability

The program and accompanying online documentation are furnished to you for use at your own risk. Onkyo will not be liable and you will have no remedy for damages for any claim of any kind whatsoever concerning your use of the program or the accompanying online documentation, regardless of legal theory, and whether arising in tort or contract. In no event will Onkyo be liable to you or any third party for any special, indirect, incidental, or consequential damages of any kind, including, but not limited to, compensation, reimbursement or damages on account of the loss of present or prospective profits, loss of data, or for any other reason whatsoever.

See the Onkyo web site for latest information.

Updating the Firmware via Network

The AV receiver allows you to update the firmware using network connection on the rear panel.

Note

- Make sure your AV receiver and TV are turned on and an Ethernet cable is connected to the rear panel of the AV receiver.
- Never unplug or turn off the AV receiver while it is being updated.
- Never plug or unplug an HDMI or Ethernet cable during the update process.
- Do not attempt to access the AV receiver from your PC while it is being updated.
- Never unplug the power cord during the update process.
- It takes maximum 60 minutes to complete the firmware update.
- The AV receiver will retain all your settings after the update is finished.

Before you start

- Set the “HDMI Control (RIHD)” setting to “Off” (→ page 51).
- Turn off the controller device connected via Ethernet cable.
- Turn off Zone 2.
- Stop playback of contents from Internet Radio, iPod/iPhone, USB or servers, etc.

Update procedure

1 Press RECEIVER followed by SETUP on the remote controller.

The Setup menu will be displayed on the TV screen. The procedures thereafter can also be performed on the AV receiver by using its **SETUP**, arrow and **ENTER** buttons.

2 Select “Hardware Setup” and press ENTER.

3 Select “Firmware Update” and press ENTER.

Note that the “Firmware Update” option will be grayed out for a short while after the AV receiver is turned on. Please wait until it becomes operable.

4 Select “via NET” and press ENTER.

5 Select “Update” and press ENTER.

The update process will begin.

During the update process, the on-screen display may disappear depending on the updated program. When this occurs, you can still view the update progress on the front display of the AV receiver. The on-screen display will reappear after the update is complete, and upon turning the AV receiver off and on again.

6 The message “Completed!” appears on the front display of the AV receiver, indicating that the update has been completed.

7 Using **ON/STANDBY** on the front panel, turn off and on the AV receiver.

Do not use **RECEIVER** on the remote controller. Congratulations! You now have the latest firmware installed on your Onkyo AV receiver.

Troubleshooting

Case 1:

If “**No Update**” is displayed on the front display of the AV receiver, it means that the firmware has already been updated. You do not need to do anything further.

Case 2:

If an error occurs, “**Error!! *-** No media**” is displayed on the front display of the AV receiver. (Alpha-numeric characters on the front display are denoted by asterisks.) Refer to the following table and take appropriate action.

■ Errors during an update via network

Error Code	Description
*-10, *-20	The Ethernet cable was not detected. Reconnect the cable properly.
*-11, *-13, *-21, *-28	Internet connection error. Check the following items: <ul style="list-style-type: none">• Make sure the IP address, subnet mask, gateway address, and DNS server are configured properly.• Make sure the router is turned on.• Make sure the AV receiver and the router are connected with an Ethernet cable.• Make sure your router is configured properly. See the instruction manual of the router.• If your network allows only one client connection and there is any other device already connected, the AV receiver will not be able to access the network. Consult your Internet Service Provider (ISP).• If your modem does not function as a router, you will need a router. Depending on your network, you may need to configure the proxy server if necessary. See the document provided by your ISP. If you are still unable to access the Internet, the DNS or proxy server may be temporarily down. Contact your ISP.
Others	Retry the update procedure from the beginning. If the error persists, please contact Onkyo Support (→ page 75) and provide the error code.

Case 3:

If an error occurs during the update process, disconnect then reconnect the AC power cord and try again.

Case 4:

If an error occurs due to a wrong selection of input sources, turn off and on the AV receiver. Then retry the update.

Case 5:

If you do not have an Internet connection, please contact Onkyo Support (→ **page 75**).

Updating the Firmware via USB

The AV receiver allows you to update the firmware using a USB device.

Note

- Never unplug or turn off the AV receiver during the update process.
- Never plug or unplug an HDMI cable or a USB device during the update process.
- Never unplug the USB storage device containing the firmware file or the AC power cord during the update process.
- Do not attempt to access the AV receiver from your PC while it is being updated.
- It takes maximum 60 minutes to complete the firmware update.
- The AV receiver will retain all your settings after the update is finished.

Before you start

- Set the “**HDMI Control (RIHD)**” setting to “**Off**” (→ **page 51**).
- Turn off the controller device connected via Ethernet cable.
- Turn off Zone 2.
- Stop playback of contents from Internet Radio, iPod/iPhone, USB or servers, etc.
- If there is any data in the USB device, remove it first.

Update procedure

- 1 Connect a USB device to your PC. If there is any data in the USB device, remove it first.**
- 2 Download the firmware file from the Onkyo web site. The file name is as follows:**
ONKA VR**_*****.zip**
Unzip the downloaded file. The following three files are created:
ONKA VR**_*****.of1**
ONKA VR**_*****.of2**
ONKA VR**_*****.of3**
- 3 Copy the extracted files to the USB device. Be careful not to copy the zip file.**
- 4 Remove the USB device from your PC and connect it to the USB port on the AV receiver.**
- 5 Make sure the AV receiver and TV are turned on.** If the AV receiver is in standby mode, press **ON/STANDBY** on the AV receiver to light up the front display.
- 6 Select the USB input source.** “**Now Initializing**” is displayed on the front display and then the name of the USB device is displayed. It takes 20 to 30 seconds to recognize the USB device.
- 7 Press RECEIVER followed by SETUP on the remote controller.**
The setup menu will be displayed on the TV screen. The procedures thereafter can also be performed on the AV receiver by using its **SETUP**, arrow and **ENTER** buttons.

8 Select “Hardware Setup” and press **ENTER**.

9 Select “Firmware Update” and press **ENTER**.

10 Select “via USB” and press **ENTER**.

11 Select “Update” and press **ENTER**.

The update process will begin.

During the update process, the on-screen display may disappear depending on the updated program. When this occurs, you can still view the update progress on the front display of the AV receiver. The on-screen display will reappear after the update is complete, and upon turning the AV receiver off and on again.

Do not turn off the AV receiver and do not remove the USB device during the update process.

12 The message “Completed!” appears on the front display of the AV receiver, indicating that the update has been completed.

13 Using **ON/STANDBY** on the front panel, turn off the AV receiver and then remove the USB device.

Do not use **RECEIVER** on the remote controller. Congratulations! You now have the latest firmware installed on your Onkyo AV receiver.

Troubleshooting

Case 1:

If “No Update” is displayed on the front display of the AV receiver, it means that the firmware has already been updated. You do not need to do anything further.

Case 2:

If an error occurs, “Error!! *.* No media” is displayed on the front display of the AV receiver. (Alpha-numeric characters on the front display are denoted by asterisks.) Refer to the following table and take appropriate action.

■ Errors during an update via USB

Error Code	Description
*-10, *-20	The USB device was not detected. Make sure the USB flash memory or USB cable is properly connected to the USB port. If the USB storage device has its own power supply, use it to power the USB device.
*-14	The firmware file was not found in the root folder of the USB device, or the firmware file is for another model. Retry and download the file on the support page of the web site, following the on-site instructions. If the error persists, please contact Onkyo Support and provide the error code.
Others	Retry the update procedure from the beginning. If the error persists, please contact Onkyo Support and provide the error code.

Case 3:

If an error occurs during the update, disconnect then reconnect the AC power cord and try again.

Case 4:

If an error occurs due to a wrong selection of input sources, turn off and on the AV receiver. Then retry the update.

ONKYO SOUND & VISION CORPORATION

2-1, Nisshin-cho, Neyagawa-shi, OSAKA 572-8540, JAPAN

The Americas

ONKYO U.S.A. CORPORATION
18 Park Way, Upper Saddle River, N.J. 07458, U.S.A.
Tel: 800-229-1687, 201-785-2600
Fax: 201-785-2650
Hours: M-F 9am-8pm/Sat-Sun 10am-4pm ET
<<http://www.us.onkyo.com/>>

Europe

ONKYO EUROPE ELECTRONICS GmbH
Liegnitzerstrasse 6, 82194 Groebenzell, GERMANY
Tel: +49-8142-4401-0 Fax: +49-8142-4401-555
<<http://www.eu.onkyo.com/>>

China, Hong Kong

ONKYO CHINA LIMITED
Unit 1&12, 9/F, Ever Gain Plaza Tower 1, 88, Container Port Road,
Kwai Chung, N.T., Hong Kong
Tel: 852-2429-3118 Fax: 852-2428-9039
<<http://www.onkyochina.com/>>

Asia, Oceania, Middle East, Africa

Please contact an ONKYO distributor referring to Onkyo SUPPORT site.
<http://www.intl.onkyo.com/support/local_support/index.html>

Connection Tips and Video Signal Path

The AV receiver supports several connection formats for compatibility with a wide range of AV equipment. The format you choose will depend on the formats supported by your components. Use the following sections as a guide.

The on-screen setup menus appear only on a TV that is connected to the HDMI OUT. If your TV is connected to other video outputs, use the AV receiver's display when changing settings.

Video Connection Formats

Video component can be connected by using any one of the following video connection formats: composite video, PC IN (Analog RGB), component video or HDMI, the latter offering the best picture quality.

Video input signals flow through the AV receiver as shown, with composite video, PC IN (Analog RGB) and component video sources all being upconverted for the HDMI output. The composite video and component video outputs carry their respective input signals as they are.

When you connect a video component to an HDMI or COMPONENT input, you must assign that input to an input selector (→ [page 40](#)).

■ Signal Selection

If signals are present at more than one input, the inputs will be selected automatically in the following order of priority: HDMI, component video, composite video.

However, for component video only, regardless of whether a component video signal is actually present, if a component video input is assigned to the input selector, that component video input will be selected. And if no component video input is assigned to the input selector, this will be interpreted as no component video signal being present.

In the Signal Selection Example shown on the right, video signals are present at both the HDMI and composite video inputs. However, the HDMI signal is automatically selected as the source and the video is output by the HDMI output.

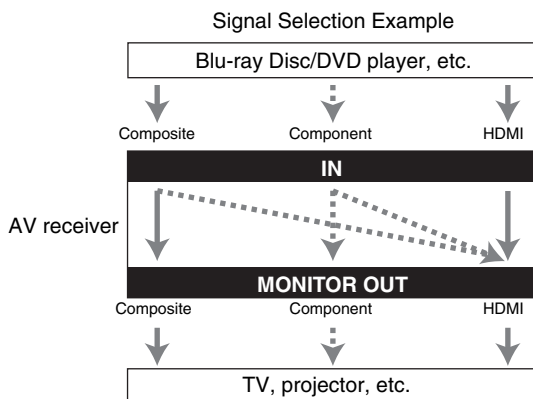
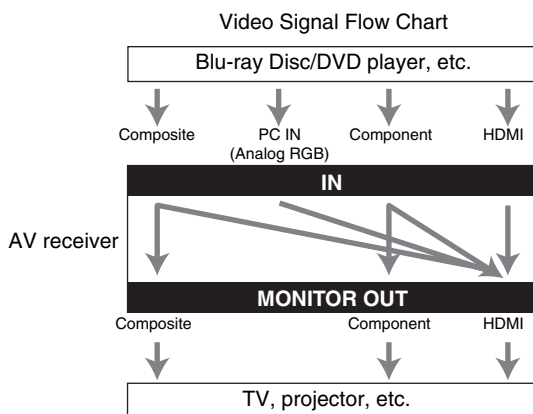

Audio Connection Formats

Audio components can be connected by using any of the following audio connection formats: analog, optical, coaxial, or HDMI.

When choosing a connection format, bear in mind that the AV receiver does not convert digital input signals for analog line outputs and vice versa. For example, audio signals connected to an optical or coaxial digital input are not output by the analog **VCR/DVR OUT**.

If signals are present at more than one input, the inputs will be selected automatically in the following order of priority: HDMI, digital, analog.

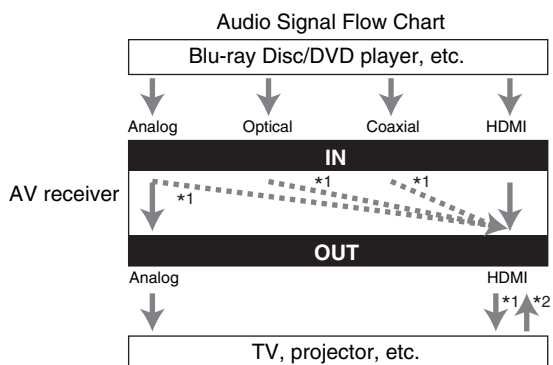

*1 Depends on the "Audio TV Out" setting (→ page 52).

*2 This is possible when "Audio Return Channel" is set to "Auto" (→ page 52), the TV/CD input selector is selected, and your TV is ARC capable.

About HDMI

Designed to meet the increased demands of digital TV, HDMI (High Definition Multimedia Interface) is a new digital interface standard for connecting TVs, projectors, Blu-ray Disc/DVD players, set-top boxes, and other video components. Until now, several separate video and audio cables have been required to connect AV components. With HDMI, a single cable can carry control signals, digital video, and up to eight channels of digital audio (2-channel PCM, multichannel digital audio, and multichannel PCM).

The HDMI video stream (i.e., video signal) is compatible with DVI (Digital Visual Interface)*1, so TVs and displays with a DVI input can be connected by using an HDMI-to-DVI adapter cable. (This may not work with some TVs and displays, resulting in no picture.)

The AV receiver uses HDCP (High-bandwidth Digital Content Protection)*2, so only HDCP-compatible components can display the picture.

The AV receiver's HDMI interface is based on the following:

Audio Return Channel, 3D, x.v.Color, DeepColor, Lip Sync, DTS-HD Master Audio, DTS-HD High Resolution Audio, Dolby TrueHD, Dolby Digital Plus, DSD and Multichannel PCM.

Supported Audio Formats

- 2-channel linear PCM (32–192 kHz, 16/20/24 bit)
- Multichannel linear PCM (up to 7.1 ch, 32–192 kHz, 16/20/24 bit)
- Bitstream (DSD, Dolby Digital, Dolby Digital Plus, Dolby TrueHD, DTS, DTS-HD High Resolution Audio, DTS-HD Master Audio)

Your Blu-ray Disc/DVD player must also support HDMI output of the above audio formats.

About Copyright Protection

The AV receiver supports HDCP (High-bandwidth Digital Content Protection)*2, a copy-protection system for digital video signals. Other devices connected to the AV receiver via HDMI must also support HDCP.

*1 DVI (Digital Visual Interface): The digital display interface standard set by the DDWG*3 in 1999.

*2 HDCP (High-bandwidth Digital Content Protection): The video encryption technology developed by Intel for HDMI/DVI. It's designed to protect video content and requires a HDCP-compatible device to display the encrypted video.

*3 DDWG (Digital Display Working Group): Led by Intel, Compaq, Fujitsu, Hewlett Packard, IBM, NEC, and Silicon Image, this open industry group's objective is to address the industry's requirements for a digital connectivity specification for high-performance PCs and digital displays.

Note

- The HDMI video stream is compatible with DVI (Digital Visual Interface), so TVs and displays with a DVI input can be connected by using an HDMI-to-DVI adapter cable. (Note that DVI connections only carry video, so you'll need to make a separate connection for audio.) However, reliable operation with such an adapter is not guaranteed. In addition, video signals from a PC are not supported.
- The HDMI audio signal (sampling rate, bit length, etc.) may be restricted by the connected source component. If the picture is poor or there's no sound from a component connected via HDMI, check its setup. Refer to the connected component's instruction manual for details.

Using an RIHD-compatible TV, Player, or Recorder

RIHD, which stands for Remote Interactive over HDMI, is the name of the system control function found on Onkyo components. The AV receiver can be used with CEC (Consumer Electronics Control), which allows system control over HDMI and is part of the HDMI standard. CEC provides interoperability between various components, however, operation with components other than **RIHD**-compatible components cannot be guaranteed.

About RIHD-compatible components

The following components are **RIHD**-compatible (as of January 2011).

■ TV

- Toshiba REGZA-LINK compatible TV
- Sharp TV

■ Players/Recorders

- Onkyo and Integra **RIHD**-compatible players
- Toshiba REGZA-LINK compatible players and recorders (only when used together with Toshiba REGZA-LINK compatible TV)
- Sharp players and recorders (only when used together with Sharp TV)

* Models other than those mentioned above may have some interoperability if compatible with CEC, which is part of the HDMI Standard, but operation cannot be guaranteed.

Note

- For proper linked operations, do not connect more **RIHD**-compatible components than the quantities specified below, to the HDMI input terminal.
 - Blu-ray Disc/DVD players: up to three.
 - Blu-ray Disc/DVD recorders/Digital Video Recorders: up to three.
 - Cable/Satellite Set-top boxes: up to four.
- Do not connect the AV receiver to the other AV receiver/AV amplifier via HDMI.
- Proper linked operations are not guaranteed when more **RIHD**-compatible components than the above-mentioned quantities are connected.

Operations that can be performed with RIHD connection

■ For RIHD-compatible TV

The following linked operations are enabled by connecting the AV receiver to an **RIHD**-compatible TV.

- The AV receiver will enter standby mode when the power of the TV is turned to standby.
- You can set on the menu screen of the TV to either output the audio from the speakers connected to the AV receiver, or from the speakers of the TV.
- It is possible to output the video/audio coming from the antenna or from the input jack of the TV from the speakers connected to the AV receiver. (A connection such as optical digital cable or similar is required above the HDMI cable.)
- Input to the AV receiver can be selected with the remote controller of the TV.
- Operations such as volume adjustment or similar for the AV receiver can be performed from the remote controller of the TV.

■ For RIHD-compatible players/recorders

The following linked operations are enabled by connecting the AV receiver to an **RIHD**-compatible player/recorder.

- When the playback is started on the player/recorder, input of the AV receiver will switch to the HDMI input of the player/recorder that is playing back.
- Operation of the player/recorder is possible using the remote controller supplied with the AV receiver.

* Depending on the model used, not all operations may be available.

■ How to connect and setup

1 Confirm the connecting and setting.

1. Connect the **HDMI OUT** jack to the HDMI input jack of the TV.

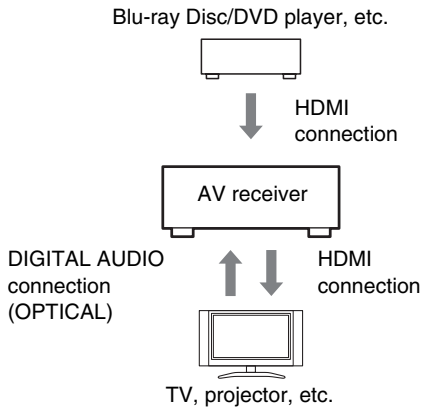

2. Connect the audio output from the TV to the **OPTICAL IN 2** jack of the AV receiver using an optical digital cable.

Note

- When the audio return channel (ARC) function is used with an ARC capable TV, this connection is not necessary (→ [page 52](#)).
3. Connect the HDMI output of the Blu-ray Disc/DVD player/recorder to the **HDMI IN 1** jack of the AV receiver.

Note

- It is necessary to assign the HDMI input when connecting the Blu-ray Disc/DVD player/recorder to other jacks (→ [page 40](#)). Do not assign the components connected to the HDMI IN to the TV/CD input at this time. Appropriate CEC (Consumer Electronics Control) operation can not be guaranteed.

2 Change each item in the “HDMI” menu according to the following settings:

- **HDMI Control (RIHD): On**
- **Audio Return Channel (ARC): Auto**

See details of each setting (→ [pages 51, 52](#)).

3 Confirm the settings.

1. Turn on the power for all connected components.
2. Turn off the power of the TV, and confirm that the power of the connected components is turned off automatically with the link operation.
3. Turn on the power of the Blu-ray Disc/DVD player/recorder.
4. Start playback on the Blu-ray Disc/DVD player/recorder, and verify the following.
 - The AV receiver automatically turns on, and selects the input to which the Blu-ray Disc/DVD player/recorder is connected.
 - The TV automatically turns on, and selects the input to which the AV receiver is connected.
5. Following the operating instructions of the TV, select “Use the TV speakers” from the menu screen of the TV, and confirm that the audio is output from the speakers of the TV, and not from the speakers connected to the AV receiver.
6. Select “Use the speakers connected from the AV receiver” from the menu screen of the TV, and confirm that the audio is output from the speakers connected to the AV receiver, and not from the TV speakers.

Note

- Perform the above operations when you use the AV receiver for the first time, when the settings of each component are changed, when the main power of each component is turned off, when the power cable is disconnected from the power supply, or when there has been a power outage.

4 Operate with the remote controller.

For buttons that can be operated (→ [page 62](#)).

Note

- Audio from DVD-Audio or Super Audio CD may not output from the TV speakers. You will be able to output the audio from the TV speakers by setting the audio output of the DVD player to 2ch PCM. (It may not be possible depending on the player models.)
- Even if you set to output audio on the TV speakers, audio will be output from the speakers connected to the AV receiver when you adjust the volume or switch the input on the AV receiver. To output audio from the TV speakers, redo the operations on the TV.
- In case of an **RIHD** connection with **RI** and **RI** audio control compatible components, do not connect the **RI** cable at the same time.
- On the TV, when you select anything other than the HDMI jack to which the AV receiver is connected, the input on the AV receiver will be switched to “**TV/CD**”.
- The AV receiver will automatically power on in conjunction when it determines it to be necessary. Even if the AV receiver is connected to an **RIHD** compatible TV or player/recorder, it will not power on if it is not necessary. It may not power on in conjunction when the TV is set to output audio from the TV.
- Linked functions with the AV receiver may not work depending on the component model connected. In such cases, operate the AV receiver directly.

Specifications

Amplifier Section

Rated Output Power All channels:	80 watts minimum continuous power per channel, 8 ohm loads, 2 channels driven from 20 Hz to 20 kHz, with a maximum total harmonic distortion of 0.7% (FTC) 130 watts minimum continuous power per channel, 6 ohm loads, 1 channels driven at 1 kHz, with a maximum total harmonic distortion of 1% (FTC) 110 watts minimum continuous power per channel, 6 ohm loads, 2 channels driven at 1 kHz, with a maximum total harmonic distortion of 0.9% (FTC)
--	---

Dynamic Power*

* IEC60268-Short-term maximum output power

180 W (3 Ω , Front)
160 W (4 Ω , Front)
100 W (8 Ω , Front)

THD+N (Total Harmonic Distortion+Noise)

0.08% (20 Hz - 20 kHz, half power)

Damping Factor 60 (Front, 1 kHz, 8 Ω)

Input Sensitivity and Impedance (Unbalance)

200 mV/47 k Ω (LINE)

Rated RCA Output Level and Impedance

200 mV/2.2 k Ω (REC OUT)

Maximum RCA Output Level and Impedance

2 V/2.2 k Ω (REC OUT)

Frequency Response 20 Hz - 50 kHz/+1 dB, -3 dB (DSP bypass)

Tone Control Characteristics

\pm 10 dB, 50 Hz (BASS)
 \pm 10 dB, 20 kHz (TREBLE)

Signal to Noise Ratio 100 dB (LINE, IHF-A)

Speaker Impedance 6 Ω - 16 Ω

Video Section

Input Sensitivity/Output Level and Impedance

1 V_{p-p}/75 Ω (Component Y)
0.7 V_{p-p}/75 Ω (Component P_B/C_B, P_R/C_R)
1 V_{p-p}/75 Ω (Composite)

Component Video Frequency Response

5 Hz - 100 MHz/+0 dB, -3 dB

Tuner Section

FM Tuning Frequency Range

87.5 MHz - 107.9 MHz

AM Tuning Frequency Range

530 kHz - 1710 kHz

Preset Channel

40

General

Power Supply	AC 120 V, 60 Hz
Power Consumption	4.5 A
No-sound power consumption	55 W
Stand-by Power Consumption	0.2 W
Dimensions (W × H × D)	435 mm × 173.5 mm × 328 mm 17-1/8" × 6-13/16" × 12-15/16"
Weight	19.2 kg (8.7 lbs.)

■ HDMI

Input	IN 1, IN 2, IN 3, IN 4
Output	OUT
Video Resolution	1080p
Audio Format	Dolby TrueHD, DTS-HD Master Audio, DVD-Audio, DSD
Supported	3D, Audio Return Channel, DeepColor, x.v.Color, LipSync, CEC (RIHD)

■ Video Inputs

Component	IN 1, IN 2
Composite	BD/DVD, VCR/DVR, CBL/SAT, GAME, AUX
Analog RGB	PC IN

■ Video Outputs

Component	OUT
Composite	MONITOR OUT, VCR/DVR OUT

■ Audio Inputs

Digital	Optical: 2 Coaxial: 2
Analog	BD/DVD, VCR/DVR, CBL/SAT, GAME, TV/CD, AUX

■ Audio Outputs

Analog	VCR/DVR, ZONE2 LINE OUT
Subwoofer Pre Output	1

Speaker Outputs Main (L, R, C, SL, SR, SBL/FHL, SBR/FHR) + ZONE2 (L, R)

Phones 1 (6.3 ϕ)

■ Others

Setup Mic	1
Universal Port	1
RI	1
USB	1 (Front)
Ethernet	1

Specifications and features are subject to change without notice.

Video Resolution Chart

The following tables show how video signals at different resolutions are output by the AV receiver.

✓: Output

Input \ Output		HDMI						
		4K*2	1080p/24	1080p	1080i	720p	480p	480i
HDMI	1080p	✓	✓	✓				
	1080i	✓	✓	✓	✓	✓		
	720p	✓	✓	✓	✓	✓		
	480p	✓	✓	✓	✓	✓	✓	
	480i	✓	✓	✓	✓	✓	✓	✓
Component	1080p	✓	✓	✓				
	1080i	✓	✓	✓	✓	✓		
	720p	✓	✓	✓	✓	✓		
	480p	✓	✓	✓	✓	✓	✓	
	480i	✓	✓	✓	✓	✓	✓	✓
Composite	480i	✓	✓	✓	✓	✓	✓	✓
PC IN (Analog RGB)*1		✓	✓	✓	✓	✓	✓	

Input \ Output		Component					Composite
		1080p	1080i	720p	480p	480i	480i
HDMI	1080p						
	1080i						
	720p						
	480p						
	480i						
Component	1080p	✓					
	1080i		✓				
	720p			✓			
	480p				✓		
	480i					✓	
Composite	480i						✓
PC IN (Analog RGB)*1							

*1 Available resolutions: [640 × 480 60 Hz], [800 × 600 60 Hz], [1024 × 768 60 Hz], [1280 × 1024 60 Hz]

*2 Available resolutions: [3840 × 2160 24/25/30 Hz]

Memo

ONKYO®

ONKYO SOUND & VISION CORPORATION
2-1, Nisshin-cho, Neyagawa-shi, OSAKA 572-8540, JAPAN
Tel: 072-831-8023 Fax: 072-831-8163
<http://www.onkyo.com/>

ONKYO U.S.A. CORPORATION
18 Park Way, Upper Saddle River, N.J. 07458, U.S.A.
Tel: 800-229-1687, 201-785-2600 Fax: 201-785-2650
<http://www.us.onkyo.com/>

ONKYO EUROPE ELECTRONICS GmbH
Liegnitzerstrasse 6, 82194 Groebenzell, GERMANY
Tel: +49-8142-4401-0 Fax: +49-8142-4401-555
<http://www.eu.onkyo.com/>

ONKYO EUROPE ELECTRONICS GmbH (UK BRANCH)
The Coach House 81A High Street, Marlow, Buckinghamshire, SL7 1AB, UK
Tel: +44-(0)1628-473-350 Fax: +44-(0)1628-401-700

ONKYO CHINA LIMITED
Unit 1 & 12, 9/F, Ever Gain Plaza Tower 1, 88, Container Port Road, Kwai Chung,
N.T., Hong Kong. Tel: 852-2429-3118 Fax: 852-2428-9039
<http://www.ch.onkyo.com/>

ONKYO CHINA PRC
1301, 555 Tower, No.555 West NanJin Road, Jin an, Shanghai,
China 200041, Tel: 86-21-52131366 Fax: 86-21-52130396

Y1103-1

SN 29400659

(C) Copyright 2011 ONKYO SOUND & VISION CORPORATION Japan. All rights reserved.



* 2 9 4 0 0 6 5 9 *