

# ONKYO®

## AV Receiver

# HT-RC270

## Instruction Manual

Thank you for purchasing an Onkyo AV Receiver. Please read this manual thoroughly before making connections and plugging in the unit. Following the instructions in this manual will enable you to obtain optimum performance and listening enjoyment from your new AV Receiver. Please retain this manual for future reference.

## Contents

Introduction .....2

Connections.....13

Turning On & Basic Operations .....24

Advanced Operations .....41

Controlling iPod & Other  
Components.....71

Others.....82



## WARNING:

TO REDUCE THE RISK OF FIRE OR ELECTRIC SHOCK, DO NOT EXPOSE THIS APPARATUS TO RAIN OR MOISTURE.

## CAUTION:

TO REDUCE THE RISK OF ELECTRIC SHOCK, DO NOT REMOVE COVER (OR BACK). NO USER-SERVICEABLE PARTS INSIDE. REFER SERVICING TO QUALIFIED SERVICE PERSONNEL.



**WARNING**  
RISK OF ELECTRIC SHOCK  
DO NOT OPEN

**AVIS**  
RISQUE DE CHOC ELECTRIQUE  
NE PAS OUVRIR



The lightning flash with arrowhead symbol, within an equilateral triangle, is intended to alert the user to the presence of uninsulated “dangerous voltage” within the product’s enclosure that may be of sufficient magnitude to constitute a risk of electric shock to persons.



The exclamation point within an equilateral triangle is intended to alert the user to the presence of important operating and maintenance (servicing) instructions in the literature accompanying the appliance.

## Important Safety Instructions

1. Read these instructions.
2. Keep these instructions.
3. Heed all warnings.
4. Follow all instructions.
5. Do not use this apparatus near water.
6. Clean only with dry cloth.
7. Do not block any ventilation openings. Install in accordance with the manufacturer’s instructions.
8. Do not install near any heat sources such as radiators, heat registers, stoves, or other apparatus (including amplifiers) that produce heat.
9. Do not defeat the safety purpose of the polarized or grounding-type plug. A polarized plug has two blades with one wider than the other. A grounding type plug has two blades and a third grounding prong. The wide blade or the third prong are provided for your safety. If the provided plug does not fit into your outlet, consult an electrician for replacement of the obsolete outlet.
10. Protect the power cord from being walked on or pinched particularly at plugs, convenience receptacles, and the point where they exit from the apparatus.
11. Only use attachments/accessories specified by the manufacturer.
12. Use only with the cart, stand, tripod, bracket, or table specified by the manufacturer, or sold with the apparatus. When a cart is used, use caution when moving the cart/apparatus combination to avoid injury from tip-over.  

PORTABLE CART WARNING  
S3125A
13. Unplug this apparatus during lightning storms or when unused for long periods of time.
14. Refer all servicing to qualified service personnel. Servicing is required when the apparatus has been damaged in any way, such as power-supply cord or plug is damaged, liquid has been spilled or objects have fallen into the apparatus, the apparatus has been exposed to rain or moisture, does not operate normally, or has been dropped.
15. Damage Requiring Service  
Unplug the apparatus from the wall outlet and refer servicing to qualified service personnel under the following conditions:
  - A. When the power-supply cord or plug is damaged,
  - B. If liquid has been spilled, or objects have fallen into the apparatus,
  - C. If the apparatus has been exposed to rain or water,
  - D. If the apparatus does not operate normally by following the operating instructions. Adjust only those controls that are covered by the operating instructions as an improper adjustment of other controls may result in damage and will often require extensive work by a qualified technician to restore the apparatus to its normal operation,
  - E. If the apparatus has been dropped or damaged in any way, and
  - F. When the apparatus exhibits a distinct change in performance this indicates a need for service.
16. Object and Liquid Entry  
Never push objects of any kind into the apparatus through openings as they may touch dangerous voltage points or short-out parts that could result in a fire or electric shock.  
The apparatus shall not be exposed to dripping or splashing and no objects filled with liquids, such as vases shall be placed on the apparatus.  
Don’t put candles or other burning objects on top of this unit.
17. Batteries  
Always consider the environmental issues and follow local regulations when disposing of batteries.
18. If you install the apparatus in a built-in installation, such as a bookcase or rack, ensure that there is adequate ventilation.  
Leave 20 cm (8") of free space at the top and sides and 10 cm (4") at the rear. The rear edge of the shelf or board above the apparatus shall be set 10 cm (4") away from the rear panel or wall, creating a flue-like gap for warm air to escape.

# Precautions

---

1. **Recording Copyright**—Unless it's for personal use only, recording copyrighted material is illegal without the permission of the copyright holder.
2. **AC Fuse**—The AC fuse inside the unit is not user-serviceable. If you cannot turn on the unit, contact your Onkyo dealer.
3. **Care**—Occasionally you should dust the unit all over with a soft cloth. For stubborn stains, use a soft cloth dampened with a weak solution of mild detergent and water. Dry the unit immediately afterwards with a clean cloth. Don't use abrasive cloths, thinners, alcohol, or other chemical solvents, because they may damage the finish or remove the panel lettering.

## 4. Power

### WARNING

BEFORE PLUGGING IN THE UNIT FOR THE FIRST TIME, READ THE FOLLOWING SECTION CAREFULLY.

AC outlet voltages vary from country to country. Make sure that the voltage in your area meets the voltage requirements printed on the unit's rear panel (e.g., AC 230 V, 50 Hz or AC 120 V, 60 Hz).

The power cord plug is used to disconnect this unit from the AC power source. Make sure that the plug is readily operable (easily accessible) at all times.

Pressing **ON/STANDBY** to select Standby mode does not fully shutdown the unit. If you do not intend to use the unit for an extended period, remove the power cord from the AC outlet.

## 5. Preventing Hearing Loss

### Caution

Excessive sound pressure from earphones and headphones can cause hearing loss.

## 6. Batteries and Heat Exposure

### Warning

Batteries (battery pack or batteries installed) shall not be exposed to excessive heat as sunshine, fire or the like.

7. **Never Touch this Unit with Wet Hands**—Never handle this unit or its power cord while your hands are wet or damp. If water or any other liquid gets inside this unit, have it checked by your Onkyo dealer.

## 8. Handling Notes

- If you need to transport this unit, use the original packaging to pack it how it was when you originally bought it.
- Do not leave rubber or plastic items on this unit for a long time, because they may leave marks on the case.
- This unit's top and rear panels may get warm after prolonged use. This is normal.
- If you do not use this unit for a long time, it may not work properly the next time you turn it on, so be sure to use it occasionally.

## For U.S. models

### FCC Information for User

#### CAUTION:

The user changes or modifications not expressly approved by the party responsible for compliance could void the user's authority to operate the equipment.

#### NOTE:

This equipment has been tested and found to comply with the limits for a Class B digital device, pursuant to Part 15 of the FCC Rules. These limits are designed to provide reasonable protection against harmful interference in a residential installation.

This equipment generates, uses and can radiate radio frequency energy and, if not installed and used in accordance with the instructions, may cause harmful interference to radio communications. However, there is no guarantee that interference will not occur in a particular installation. If this equipment does cause harmful interference to radio or television reception, which can be determined by turning the equipment off and on, the user is encouraged to try to correct the interference by one or more of the following measures:

- Reorient or relocate the receiving antenna.
- Increase the separation between the equipment and receiver.
- Connect the equipment into an outlet on a circuit different from that to which the receiver is connected.
- Consult the dealer or an experienced radio/TV technician for help.

## For Canadian Models

**NOTE:** THIS CLASS B DIGITAL APPARATUS COMPLIES WITH CANADIAN ICES-003.

For models having a power cord with a polarized plug:

**CAUTION:** TO PREVENT ELECTRIC SHOCK, MATCH WIDE BLADE OF PLUG TO WIDE SLOT, FULLY INSERT.

## Modèle pour les Canadien

**REMARQUE:** CET APPAREIL NUMÉRIQUE DE LA CLASSE B EST CONFORME À LA NORME NMB-003 DU CANADA.

Sur les modèles dont la fiche est polarisée:

**ATTENTION:** POUR ÉVITER LES CHOCS ÉLECTRIQUES, INTRODUIRE LA LAME LA PLUS LARGE DE LA FICHE DANS LA BORNE CORRESPONDANTE DE LA PRISE ET POUSSER JUSQU'AU FOND.

# Supplied Accessories

Make sure you have the following accessories:

**Indoor FM antenna** (→ 21)

**AM loop antenna** (→ 21)

**Speaker cable labels** (→ 13)

**Speaker setup microphone** (→ 29)

**Remote controller and two batteries (AA/R6)**

\* In catalogs and on packaging, the letter at the end of the product name indicates the color. Specifications and operations are the same regardless of color.

## Using the Remote Controller

### Installing the Batteries

#### Note

- If the remote controller doesn't work reliably, try replacing the batteries.
- Don't mix new and old batteries or different types of batteries.
- If you intend not to use the remote controller for a long time, remove the batteries to prevent damage from leakage or corrosion.
- Remove expired batteries as soon as possible to prevent damage from leakage or corrosion.

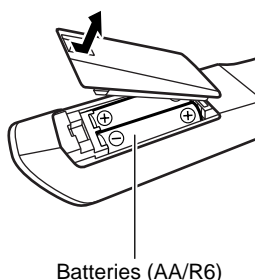

### Aiming the Remote Controller

To use the remote controller, point it at the AV receiver's remote control sensor, as shown below.

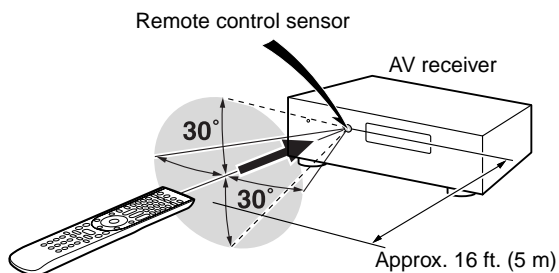

# Contents

<b>Introduction</b>	
<b>Important Safety Instructions</b> .....	<b>2</b>
<b>Precautions</b> .....	<b>3</b>
<b>Supplied Accessories</b> .....	<b>4</b>
Using the Remote Controller .....	4
<b>Features</b> .....	<b>6</b>
<b>Front &amp; Rear Panels</b> .....	<b>8</b>
Front Panel.....	8
Display.....	9
Rear Panel .....	10
<b>Remote Controller</b> .....	<b>11</b>
Controlling the AV Receiver .....	11
<b>About Home Theater</b> .....	<b>12</b>
Enjoying Home Theater.....	12

<b>Connections</b>	
<b>Connecting the AV Receiver</b> .....	<b>13</b>
Connecting Your Speakers .....	13
About AV Connections .....	17
Connecting Your Components with HDMI.....	18
Connecting Your Components .....	19
Connecting Onkyo <b>RI</b> Components .....	20
Connecting Antenna.....	21
Which Connections Should I Use? .....	22

<b>Turning On &amp; Basic Operations</b>	
<b>Turning On/Off the AV Receiver</b> .....	<b>24</b>
Turning On .....	24
Turning Off .....	24
<b>Basic Operations</b> .....	<b>25</b>
Selecting the Language Used for the Onscreen Setup Menus .....	25
Playing the Connected Component.....	25
Displaying Source Information .....	25
Setting the Display Brightness .....	25
Muting the AV Receiver.....	26
Using the Sleep Timer.....	26
Selecting Speaker Layout .....	26
Using the Home Menu.....	26
Changing the Input Display .....	27
Using Headphones.....	27
Using Easy Macros .....	28
Audyssey MultEQ® Room Correction and Speaker Setup .....	29
<b>Listening to the Radio</b> .....	<b>32</b>
Using the Tuner.....	32
Presetting FM/AM Stations.....	33
<b>Recording</b> .....	<b>34</b>
<b>Using the Listening Modes</b> .....	<b>35</b>
Selecting Listening Modes .....	35
About Listening Modes.....	36

<b>Advanced Operations</b>	
<b>Advanced Setup</b> .....	<b>41</b>
On-screen Setup Menus.....	41
Common Procedures in Setup Menu .....	41
Input/Output Assign .....	42
Speaker Setup .....	44
Audio Adjust .....	47
Source Setup.....	48
Listening Mode Preset.....	52
Miscellaneous .....	53
Hardware Setup.....	53
Lock Setup.....	56
Using the Audio Settings .....	56
<b>NET/USB</b> .....	<b>59</b>
About NET .....	59
Connecting the AV Receiver .....	59
Listening to Internet Radio.....	60
Playing Music Files on a Server .....	61
Remote Playback from Media Server/ Personal Computer .....	64
Network Settings .....	65
About USB .....	66
<b>Zone 2</b> .....	<b>68</b>
Connecting Zone 2 .....	68
Setting the Powered Zone 2 .....	69
Using Zone 2 .....	69

<b>Controlling iPod &amp; Other Components</b>	
<b>Controlling iPod</b> .....	<b>71</b>
Connecting the iPod Directly to the USB Port .....	71
Connecting an Onkyo Dock.....	72
Using the Onkyo Dock.....	73
Controlling Your iPod.....	74
<b>Controlling Other Components</b> .....	<b>76</b>
Preprogrammed Remote Control Codes .....	76
Looking up for Remote Control Code .....	76
Entering Remote Control Codes.....	77
Remote Control Codes for Onkyo Components Connected via <b>RI</b> .....	77
Resetting REMOTE MODE Buttons .....	78
Resetting the Remote Controller .....	78
Controlling Other Components .....	78
Learning Commands .....	80
Using Normal Macros .....	80

<b>Others</b>	
<b>Troubleshooting</b> .....	<b>82</b>
<b>Specifications</b> .....	<b>87</b>
<b>About HDMI</b> .....	<b>88</b>
<b>Using an RIHD-compatible TV, Player, or Recorder</b> ...	<b>89</b>
<b>Video Resolution Chart</b> .....	<b>91</b>

To reset the AV receiver to its factory defaults, turn it on and, while holding down VCR/DVR, press ON/STANDBY (→ 82).

# Features

## Amplifier

- 100 Watts/Channel @ 8 ohms (FTC)
- WRAT—Wide Range Amplifier Technology (5 Hz to 100 kHz bandwidth)
- Linear Optimum Gain Volume Circuitry
- H.C.P.S. (High Current Power Supply) Massive High Power Transformer

## Processing

- THX Select2 Plus<sup>\*1</sup> Certified
- HDMI Video Upscaling (to 1080p Compatible) with Faroudja DCDi Cinema Enhancement
- HDMI (Ver.1.4a with Audio Return Channel, 3D), Deep-Color, x.v.Color<sup>\*</sup>, Lip Sync, DTS<sup>\*2</sup>-HD Master Audio, DTS-HD High Resolution Audio, Dolby TrueHD<sup>\*3</sup>, Dolby Digital Plus, DSD and Multi-CH PCM
- Dolby Pro Logic IIz<sup>\*3</sup> – New Surround Format (front-high)
- Audyssey DSX<sup>TM</sup>\*4 for New Surround Channels (front-wide/front-high)
- 4 DSP Modes for Gaming; Rock/Sports/Action/RPG
- Non-Scaling Configuration
- A-Form Listening Mode Memory
- Direct Mode
- Pure Audio Mode
- Music Optimizer<sup>\*5</sup> for Compressed Digital Music files
- 192 kHz/24-bit D/A Converters
- Powerful and Highly Accurate 32-bit Processing DSP
- Jitter Cleaning Circuit Technology

## Connections

- 6 HDMI<sup>\*6</sup> Inputs (1 on front panel) and 1 Output
- Onkyo **RIHD** for System Control
- 5 Digital Inputs (2 Optical/3 Coaxial)
- Component Video Switching (2 Inputs/1 Output)
- Universal Port for the Optional Dock for iPod<sup>\*</sup>/HD Radio<sup>TM</sup>\*7 tuner module
- Dual Subwoofer Pre Out
- Banana Plug-Compatible Speaker Posts
- Powered Zone 2
- Internet Radio<sup>\*</sup> Connectivity (SIRIUS Internet Radio<sup>\*8</sup>/vTuner/Pandora/Rhapsody/Slacker/Mediafly/Napster)
  - \* Services available may vary depending on the region.
- Network Capability for Streaming Audio Files
- Bi-Amping Capability for FL/FR with SBL/SBR
- Analog RGB Video Input (D-sub 15) for PC

## Miscellaneous

- 40 FM/AM Presets
- Audyssey MultEQ<sup>\*4</sup> to Correct Room Acoustic Problems
- Audyssey Dynamic EQ<sup>\*4</sup> for Loudness Correction
- Audyssey Dynamic Volume<sup>\*4</sup> to Maintain Optimal Listening Level and Dynamic Range
- Crossover Adjustment (40/50/60/70/80/90/100/120/150/200 Hz)
- A/V Sync Control Function (up to 250 ms)
- Auto Power-down Function
- On-Screen Display via HDMI
- Preprogrammed (with onscreen display setup) RI-Compatible Learning Remote with 4 Activities and Mode-Key LEDs



Manufactured under license from THX Ltd. U.S. and foreign patent applications pending. THX and the THX logo are trademarks of THX Ltd. which are registered in some jurisdictions. All rights reserved.



Manufactured under license under U.S. Patent #'s: 5,451,942; 5,956,674; 5,974,380; 5,978,762; 6,226,616; 6,487,535; 7,212,872; 7,333,929; 7,392,195; 7,272,567 & other U.S. and worldwide patents issued & pending. DTS and the Symbol are registered trademarks, & DTS-HD, DTS-HD Master Audio, and the DTS logos are trademarks of DTS, Inc. Product includes software.

© DTS, Inc. All Rights Reserved.



Manufactured under license from Dolby Laboratories. “Dolby”, “Pro Logic”, “Surround EX” and the double-D symbol are trademarks of Dolby Laboratories.



Manufactured under license from Audyssey Laboratories<sup>TM</sup>. U.S. and foreign patents pending. Audyssey MultEQ<sup>®</sup>, Audyssey DSX<sup>TM</sup>, Audyssey Dynamic Volume<sup>®</sup> and Audyssey Dynamic EQ<sup>®</sup> are registered trademarks and trademarks of Audyssey Laboratories.

<sup>\*5</sup> Music Optimizer<sup>TM</sup> is a trademark of Onkyo Corporation.



“HDMI, the HDMI Logo, and High-Definition Multimedia Interface are trademarks or registered trademarks of HDMI Licensing LLC in the United States and other countries.”



HD Radio<sup>TM</sup> and the HD Radio Ready logo are proprietary trademarks of iBiquity Digital Corporation. To receive HD Radio broadcasts, you must install an Onkyo UP-HT1 HD Radio tuner module (sold separately).

SIRIUS, XM and all related marks and logos are trademarks of Sirius XM Radio Inc. and its subsidiaries. All rights reserved. Service not available in Alaska and Hawaii.

### **THX Select2 Plus**

Before any home theater component can be THX Select2 Plus certified, it must pass a rigorous series of quality and performance tests. Only then can a product feature the THX Select2 Plus logo, which is your guarantee that the Home Theater products you purchase will give you superb performance for many years to come. THX Select2 Plus requirements define hundreds of parameters, including power amplifier performance, and pre-amplifier performance and operation for both digital and analog domains. THX Select2 Plus receivers also feature proprietary THX technologies (e.g., THX Mode) which accurately translate movie soundtracks for home theater playback.



iPhone, iPod, iPod classic, iPod nano, iPod shuffle, and iPod touch are trademarks of Apple Inc., registered in the U.S. and other countries. iPad is a trademark of Apple Inc.

"Made for iPod" and "Made for iPhone" mean that an electronic accessory has been designed to connect specifically to iPod or iPhone, respectively, and has been certified by the developer to meet Apple performance standards. Apple is not responsible for the operation of this device or its compliance with safety and regulatory standards.

- \* "x.v.Color" is a trademark of Sony Corporation.
- \* Rhapsody and the Rhapsody logo are registered trademarks of RealNetworks, Inc.
- \* "DLNA<sup>®</sup>, the DLNA Logo and DLNA CERTIFIED<sup>™</sup> are trademarks, service marks, or certification marks of the Digital Living Network Alliance."

# Front & Rear Panels

## Front Panel

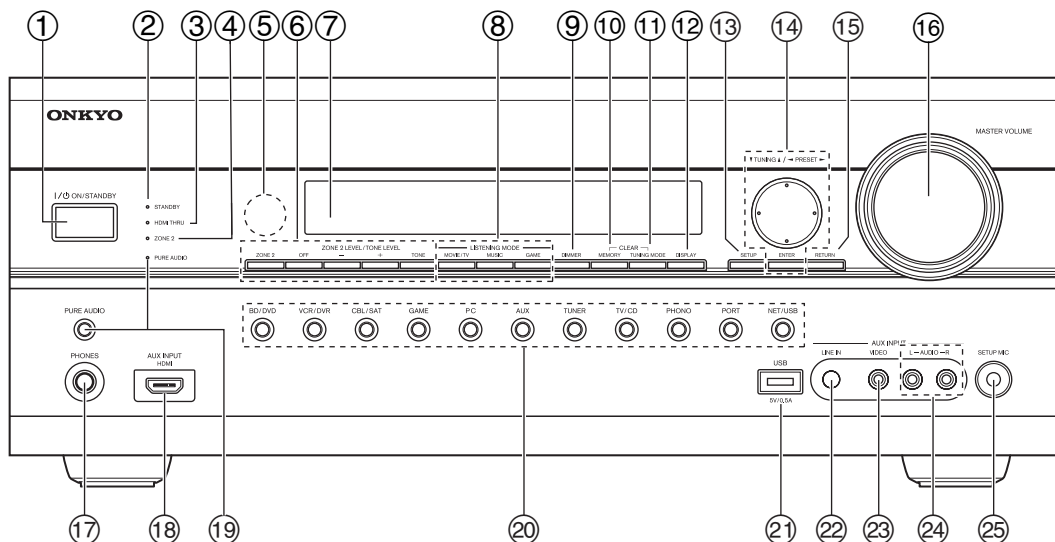

The actual front panel has various logos printed on it. They are not shown here for clarity.  
The page numbers in parentheses show where you can find the main explanation for each item.

- |  |   |
|--|---|
| ① <b>ON/STANDBY</b> button (→ 24)  | ⑭ <b>TUNING, PRESET</b> (→ 32 to 33), arrow and <b>ENTER</b> buttons  |
| ② <b>STANDBY</b> indicator (→ 24)  | ⑮ <b>RETURN</b> button  |
| ③ <b>HDMI THRU</b> indicator (→ 55)  | ⑯ <b>MASTER VOLUME</b> control and indicator (→ 25)   |
| ④ <b>ZONE 2</b> indicator (→ 69)   | ⑰ <b>PHONES</b> jack (→ 27)   |
| ⑤ <b>Remote control sensor</b> (→ 4)   | ⑱ <b>AUX INPUT HDMI</b> jack (→ 18)   |
| ⑥ <b>ZONE 2, OFF, ZONE 2 LEVEL/TONE LEVEL</b> and <b>TONE</b> buttons (→ 56, 69 to 70) | ⑲ <b>PURE AUDIO</b> button and indicator (→ 35)   |
| ⑦ <b>Display</b> (→ 9)   | ⑳ <b>Input selector buttons</b> ( <b>BD/DVD, VCR/DVR, CBL/SAT, GAME, PC, AUX, TUNER, TV/CD, PHONO, PORT</b> and <b>NET/USB</b> ) (→ 25) |
| ⑧ <b>LISTENING MODE</b> buttons ( <b>MOVIE/TV, MUSIC</b> and <b>GAME</b> ) (→ 35)      | ㉑ <b>USB</b> port (→ 66)  |
| ⑨ <b>DIMMER</b> button (→ 25)  | ㉒ <b>AUX INPUT LINE IN</b> jack (→ 19)  |
| ⑩ <b>MEMORY</b> button (→ 33)  | ㉓ <b>AUX INPUT VIDEO</b> jack (→ 19)  |
| ⑪ <b>TUNING MODE</b> button (→ 32)   | ㉔ <b>AUX INPUT AUDIO</b> jacks (→ 19)   |
| ⑫ <b>DISPLAY</b> button (→ 25)   | ㉕ <b>SETUP MIC</b> jack (→ 29)  |
| ⑬ <b>SETUP</b> button (→ 41)   |   |



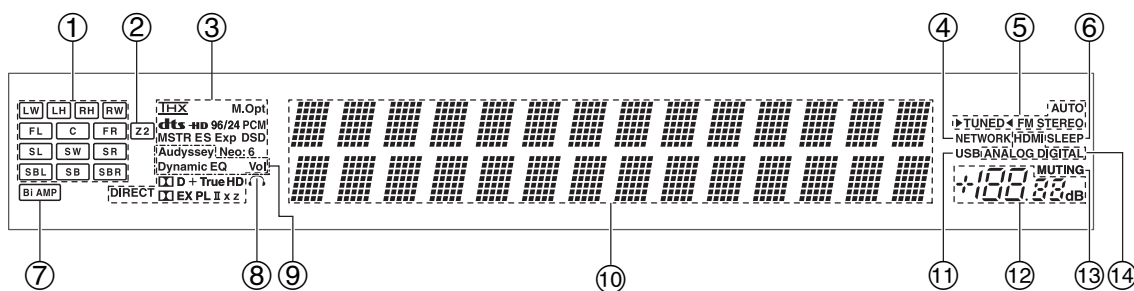

For detailed information, see the pages in parentheses.

- ① **Speaker/channel indicators**
- ② **Z2 (Powered Zone 2) indicator** (→ 69)
- ③ **Listening mode and format indicators** (→ 35, 57)
- ④ **NETWORK indicator** (→ 60)
- ⑤ **Tuning indicators**  
 AUTO indicator (→ 32)  
 TUNED indicator (→ 32)  
 FM STEREO indicator (→ 32)
- ⑥ **SLEEP indicator** (→ 26)
- ⑦ **Bi AMP indicator** (→ 16)
- ⑧ **Headphone indicator** (→ 27)
- ⑨ **Audyssey indicator** (→ 29, 48)  
 Dynamic EQ indicator (→ 48)  
 Dynamic Vol indicator (→ 49)
- ⑩ **Message area**
- ⑪ **USB indicator** (→ 66)
- ⑫ **Volume level** (→ 25)
- ⑬ **MUTING indicator** (→ 26)
- ⑭ **Audio input indicators**

## Rear Panel

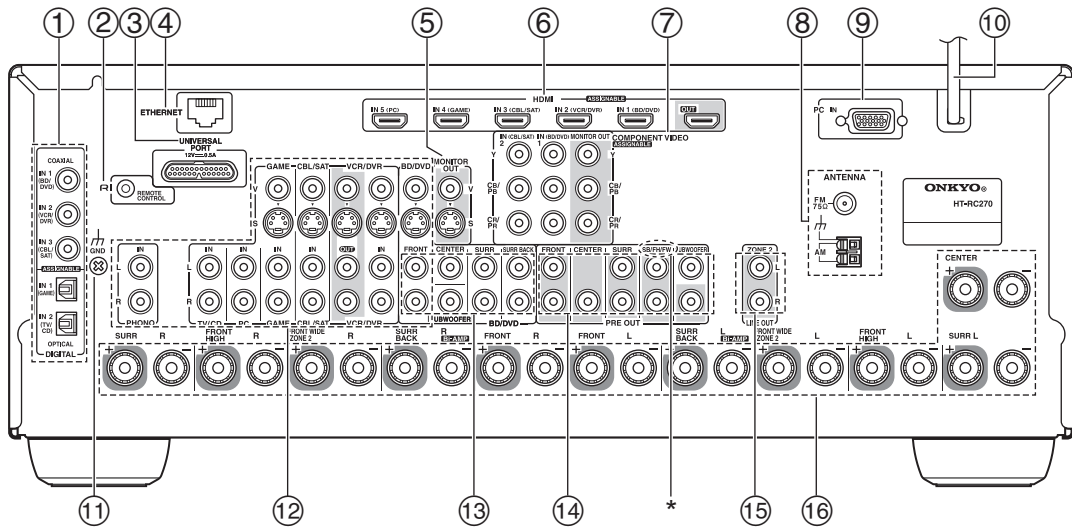

- ① **DIGITAL IN COAXIAL and OPTICAL jacks**
- ② **RI REMOTE CONTROL jack**
- ③ **UNIVERSAL PORT jack**
- ④ **ETHERNET port**
- ⑤ **MONITOR OUT V and S jacks**
- ⑥ **HDMI IN and OUT jacks**
- ⑦ **COMPONENT VIDEO IN and MONITOR OUT jacks**
- ⑧ **FM ANTENNA jack and AM ANTENNA terminal**
- ⑨ **PC IN port**
- ⑩ **Power cord**
- ⑪ **GND screw**
- ⑫ **Composite, S-Video and analog audio jacks (BD/DVD IN, VCR/DVR IN and OUT, CBL/SAT IN, GAME IN, PC IN, TV/CD IN and PHONO IN)**
- ⑬ **Multichannel input jacks (FRONT L/R, CENTER, SURR L/R, SURR BACK L/R and SUBWOOFER)**
- ⑭ **PRE OUT jacks (FRONT L/R, CENTER, SURR L/R, SB/FH/FW\* L/R and SUBWOOFER)**
- \* SB...Surround Back, FH...Front High, FW...Front Wide
- ⑮ **ZONE 2 LINE OUT jacks**
- ⑯ **Speaker Terminals (FRONT L/R, CENTER, SURR L/R, SURR BACK L/R, FRONT HIGH L/R and FRONT WIDE/ZONE 2 L/R)**

See "Connecting the AV Receiver" for connection information (→ 13 to 23).

# Remote Controller

## Controlling the AV Receiver

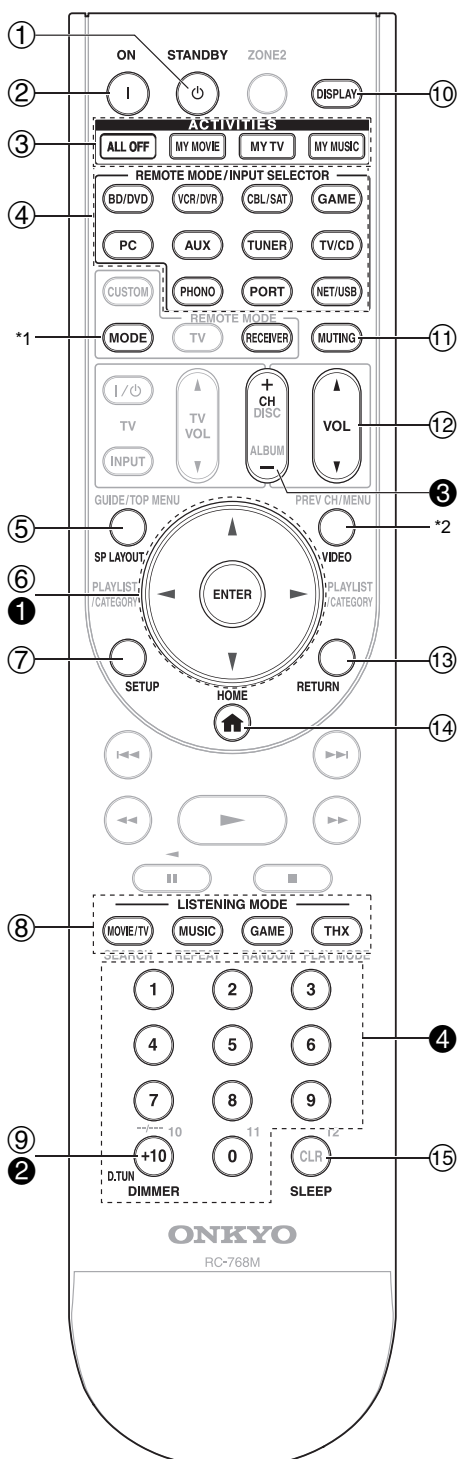

To control the AV receiver, press **RECEIVER** to select Receiver mode.

You can also use the remote controller to control Onkyo Blu-ray Disc/DVD player, CD player and other components.

See “Entering Remote Control Codes” for more details (→ 77).

For detailed information, see the pages in parentheses.

- ① **STANDBY** button (→ 24)
- ② **ON** button (→ 24)
- ③ **ACTIVITIES** buttons (**ALL OFF**, **MY MOVIE**, **MY TV** and **MY MUSIC**) (→ 28, 80)
- ④ **REMOTE MODE/INPUT SELECTOR** buttons (**BD/DVD**, **VCR/DVR**, **CBL/SAT**, **GAME**, **PC**, **AUX**, **TUNER**, **TV/CD**, **PHONO**, **PORT** and **NET/USB**) (→ 25)
- ⑤ **SP LAYOUT** button (→ 26)
- ⑥ **Arrow ▲/▼/◀/▶** and **ENTER** buttons
- ⑦ **SETUP** button (→ 41)
- ⑧ **LISTENING MODE** buttons (**MOVIE/TV**, **MUSIC**, **GAME** and **THX**) (→ 35)
- ⑨ **DIMMER** button (→ 25)
- ⑩ **DISPLAY** button (→ 25)
- ⑪ **MUTING** button (→ 26)
- ⑫ **VOL ▲/▼** button (→ 25)
- ⑬ **RETURN** button
- ⑭ **HOME** button (→ 26)
- ⑮ **SLEEP** button (→ 26)

### ■ Controlling the tuner

To control the AV receiver’s tuner, press **TUNER** (or **RECEIVER**).

You can select AM or FM by pressing **TUNER** repeatedly.

- ① **Arrow ▲/▼** buttons (→ 32)
- ② **D.TUN** button (**TUNER** remote mode only) (→ 32)
- ③ **CH +/-** button (→ 33)
- ④ **Number** buttons (→ 32)

\*1 When you want to change the remote controller mode without changing the current input source, press **MODE** and within about 8 seconds, press **REMOTE MODE**. Then, with the AV receiver’s remote controller, you can control the component corresponding to the button you pressed.

\*2 **VIDEO** functions as a short cut of **HOME**.

# About Home Theater

## Enjoying Home Theater

Thanks to the AV receiver's superb capabilities, you can enjoy surround sound with a real sense of movement in your own home—just like being in a movie theater or concert hall. With Blu-ray Discs or DVDs, you can enjoy DTS and Dolby Digital. With analog or digital TV, you can enjoy Dolby Pro Logic IIx, DTS Neo:6, or Onkyo's original DSP listening modes.

You can also enjoy THX Surround EX (THX-certified THX speaker system recommended).

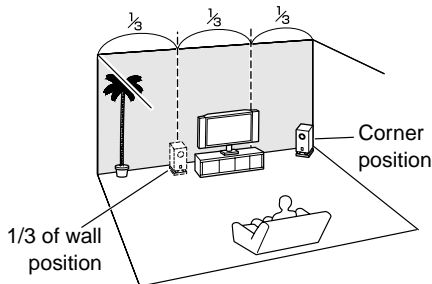
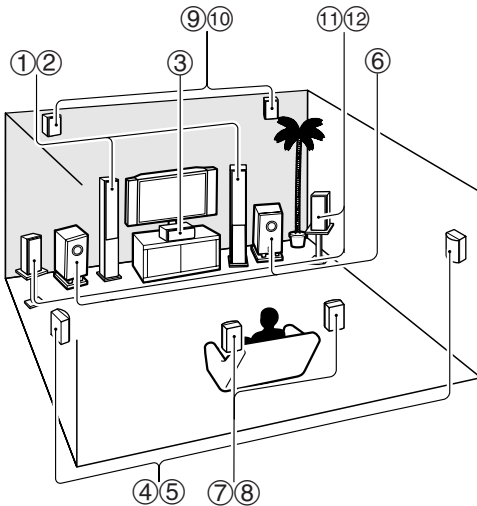

### Tip

- To find the best position for your subwoofer, while playing a movie or some music with good bass, experiment by placing your subwoofer at various positions within the room, and choose the one that provides the most satisfying results.

### ① ② **Front speakers (Left and Right)**

These output the overall sound. Their role in a home theater is to provide a solid anchor for the sound image. They should be positioned facing the listener at about ear level, and equidistant from the TV. Angle them inward so as to create a triangle, with the listener at the apex.

### ③ **Center speaker**

This speaker enhances the front speakers, making sound movements distinct and providing a full sound image. In movies it's used mainly for dialog. Position it close to your TV facing forward at about ear level, or at the same height as the front speakers.

### ④ ⑤ **Surround speakers (Left and Right)**

These speakers are used for precise sound positioning and to add realistic ambience. Position them at the sides of the listener, or slightly behind, about 2 to 3 feet (60 to 100 cm) above ear level. Ideally they should be equidistant from the listener.

### ⑥ **Subwoofer(s)**

The subwoofer handles the bass sounds of the LFE (Low-Frequency Effects) channel. The volume and quality of the bass output from your subwoofer will depend on its position, the shape of your listening room, and your listening position. In general, a good bass sound can be obtained by installing the subwoofer in a front corner, or at one-third the width of the wall, as shown.

### ⑦ ⑧ **Surround back speakers (Left and Right)**

These speakers are necessary to enjoy Dolby Digital EX, DTS-ES Matrix, DTS-ES Discrete, THX Surround EX, etc. They enhance the realism of surround sound and improve sound localization behind the listener. Position them behind the listener about 2 to 3 feet (60 to 100 cm) above ear level.

### ⑨ ⑩ **Front high speakers (Left and Right)**

These speakers are necessary to enjoy Dolby Pro Logic IIz Height, and Audyssey DSX™. They significantly enhance the spatial experience. Position them at least 3.3 feet (100 cm) above the front speakers (preferably as high as possible) and at an angle slightly wider than the front speakers.

### ⑪ ⑫ **Front wide speakers (Left and Right)**

These speakers are necessary to enjoy Audyssey DSX. They significantly enhance the spatial experience. Position them well outside of the front speakers. See also <http://www.audyssey.com/technology/dsx.html> about optimum speaker placement for Audyssey DSX.

# Connecting the AV Receiver

## Connecting Your Speakers

### Speaker Configuration

The following table indicates the channels you should use depending on the number of speakers that you have.

For 7.1-channel surround-sound playback, you need 7 speakers and a powered subwoofer.

Number of speakers	2	3	4	5	6	7	7	7	8	8	9	9	9	10	11
Front speakers	✓	✓	✓	✓	✓	✓	✓	✓	✓	✓	✓	✓	✓	✓	✓
Center speaker		✓		✓	✓	✓	✓	✓	✓	✓	✓	✓	✓	✓	✓
Surround speakers			✓	✓	✓	✓	✓	✓	✓	✓	✓	✓	✓	✓	✓
Surround back speaker*1*2					✓				✓	✓				✓	
Surround back speakers*2						✓					✓	✓			✓
Front high speakers*2							✓		✓		✓		✓	✓	✓
Front wide speakers*2								✓		✓		✓	✓	✓	✓

\*1 If you're using only one surround back speaker, connect it to the **SURR BACK L** terminals.

\*2 Front high, surround back and front wide speakers cannot be used at the same time.

No matter how many speakers you use, a powered subwoofer is recommended for a really powerful and solid bass.

To get the best from your surround sound system, you need to set the speaker settings. You can do this automatically (→ 29) or manually (→ 44).

### Attaching the Speaker Cable Labels

The AV receiver's positive (+) speaker terminals are all red (the negative (-) speaker terminals are all black).

Speaker	Color
Front left, Front high left, Front wide left, Zone 2 left	White
Front right, Front high right, Front wide right, Zone 2 right	Red
Center	Green
Surround left	Blue
Surround right	Gray
Surround back left	Brown
Surround back right	Tan

The supplied speaker cable labels are also color-coded and you should attach them to the positive (+) side of each speaker cable in accordance with the table above. Then all you need to do is to match the color of each label to the corresponding speaker terminal.



### Speaker Connection Precautions

Read the following before connecting your speakers:

- You can connect speakers with an impedance of between 4 and 16 ohms. If the impedance of any of the connected speakers is 4 ohms or more, but less than 6 ohms, be sure to set the minimum speaker impedance to "4ohms" (→ 44). If you use speakers with a lower impedance, and use the amplifier at high volume levels for a long period of time, the built-in protection circuit may be activated.
- Disconnect the power cord from the wall outlet before making any connections.
- Read the instructions supplied with your speakers.
- Pay close attention to speaker wiring polarity. In other words, connect positive (+) terminals only to positive (+) terminals, and negative (-) terminals only to negative (-) terminals. If you get them the wrong way around, the sound will be out of phase and will sound unnatural.
- Unnecessarily long, or very thin speaker cables may affect the sound quality and should be avoided.
- Be careful not to short the positive and negative wires. Doing so may damage the AV receiver.
- Make sure the metal core of the wire does not have contact with the AV receiver's rear panel. Doing so may damage the AV receiver.

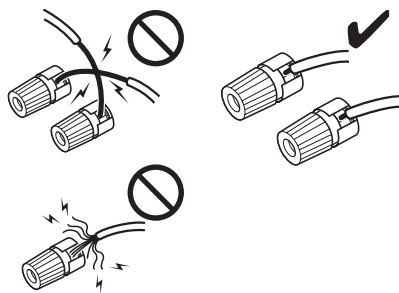

- Don't connect more than one cable to each speaker terminal. Doing so may damage the AV receiver.
- Don't connect one speaker to several terminals.

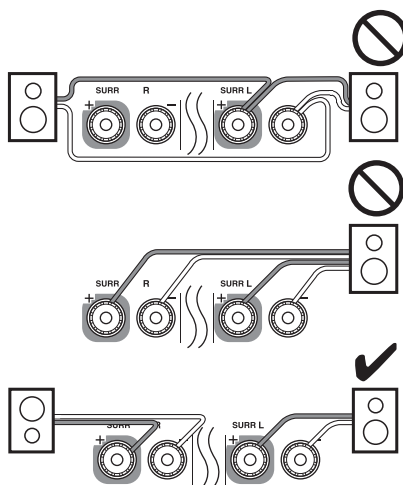

# Connecting the Speaker Cables

## Screw-type speaker terminals

Strip 1/2" to 5/8" (12 to 15 mm) of insulation from the ends of the speaker cables, and twist the bare wires tightly, as shown.

1/2" to 5/8" (12 to 15 mm)

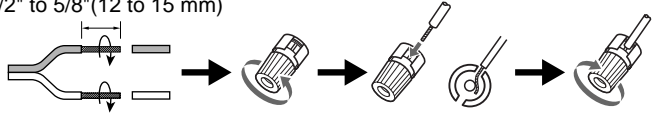

## Using Banana Plugs

- If you are using banana plugs, tighten the speaker terminal before inserting the banana plug.
- Do not insert the speaker code directly into the center hole of the speaker terminal.

The following illustration shows which speaker should be connected to each pair of terminals. If you're using only one surround back speaker, connect it to the **SURR BACK L** terminals.

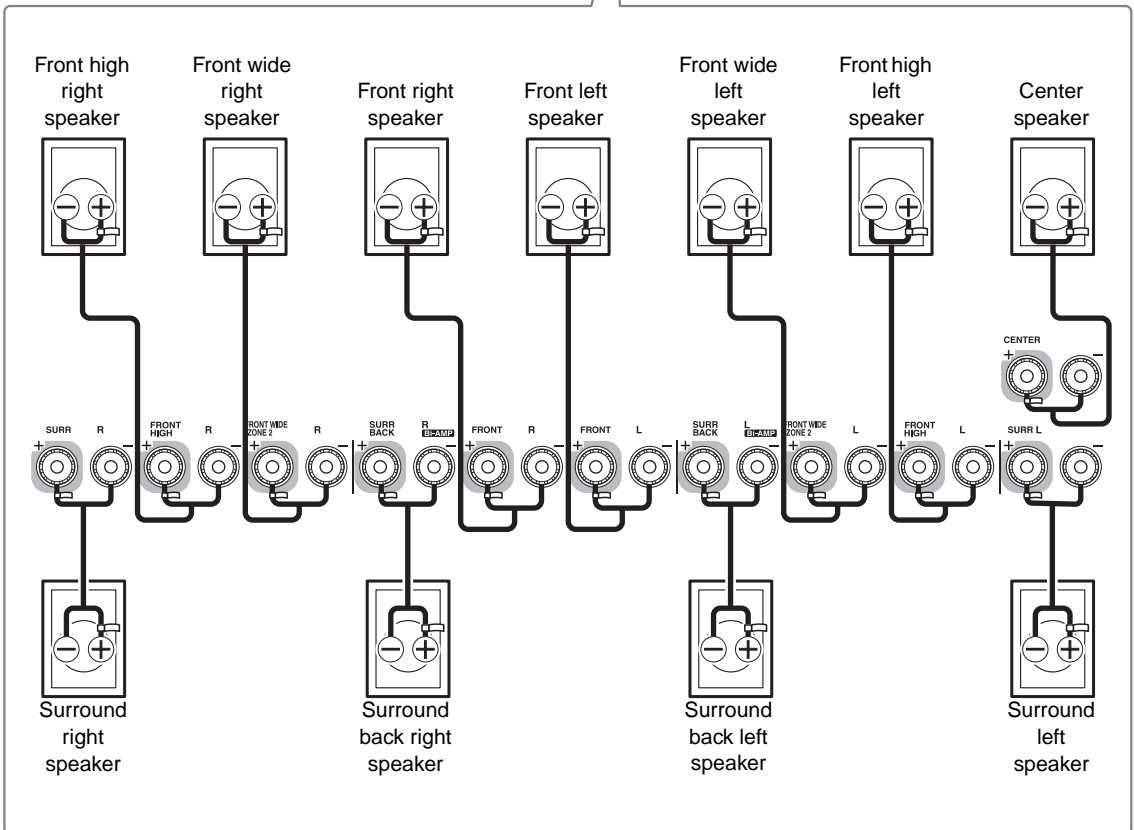
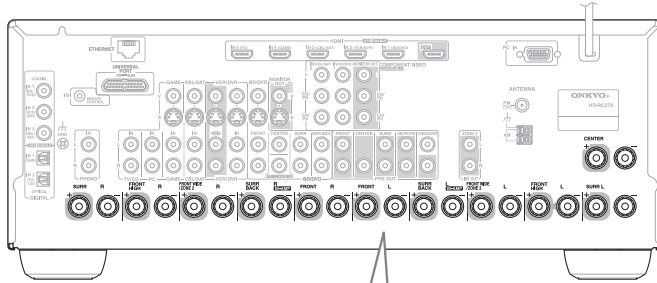

## Using Dipole Speakers

You can use dipole speakers for the surround and surround back speakers. Dipole speakers output the same sound in two directions.

Dipole speakers typically have an arrow printed on them to indicate how they should be positioned. The surround dipole speakers should be positioned so that their arrows point toward the TV/screen, while the surround back dipole speakers should be positioned so that their arrows point toward each other, as shown.

- ①② Front speakers
- ③ Center speaker
- ④⑤ Surround speakers
- ⑥ Subwoofer(s)
- ⑦⑧ Surround back speakers
- ⑨⑩ Front high speakers
- ⑪⑫ Front wide speakers

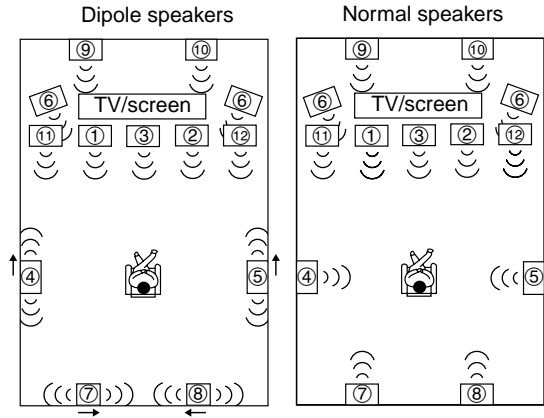

## Connecting a Powered Subwoofer

Using a suitable cable, connect the AV receiver's **SUBWOOFER PRE OUT** jack to an input on your powered subwoofer, as shown. If your subwoofer is unpowered and you're using an external amplifier, connect the **SUBWOOFER PRE OUT** jack to an input on the amp.

You can connect the powered subwoofer with two **SUBWOOFER PRE OUT** jacks respectively.

The same signal is output from each jack.

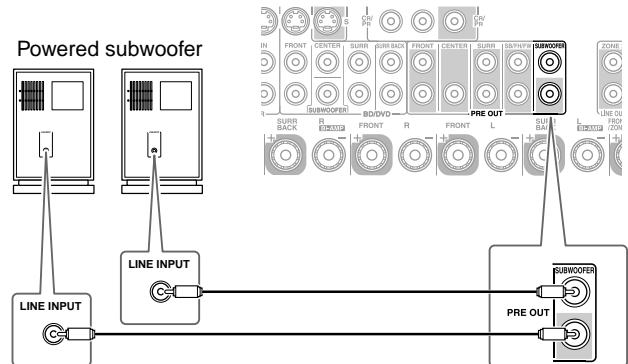

## Bi-amping the Front Speakers

The **FRONT L/R** and **SURR BACK L/R** terminal posts can be used with front speakers and surround back speakers respectively, or bi-amped to provide separate tweeter and woofer feeds for a pair of front speakers that support bi-amping, providing improved bass and treble performance.

- When bi-amping is used, the AV receiver is able to drive up to a 5.1 speaker system in the main room.
- For bi-amping, the **FRONT L/R** terminal posts connect to the front speakers' woofer terminals; the **SURR BACK L/R** terminal posts connect to the front speakers' tweeter terminals.
- Once you've completed the bi-amping connections shown below and turned on the AV receiver, you must set the "Speakers Type(Front)" setting to "Bi-Amp" to enable bi-amping (→ 44).

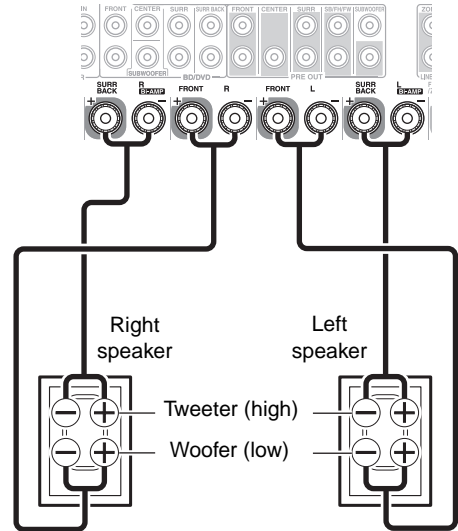

### Important:

- When making the bi-amping connections, be sure to remove the jumper bars that link the speakers' tweeter (high) and woofer (low) terminals.
- Bi-amping can be used only with speakers that support bi-amping. Refer to your speaker manual.

## Connecting a Power Amplifier

If you want to use a more powerful power amplifier and use the AV receiver as a preamp, connect it to the **PRE OUT** jacks, and connect all speakers to the power amplifier.

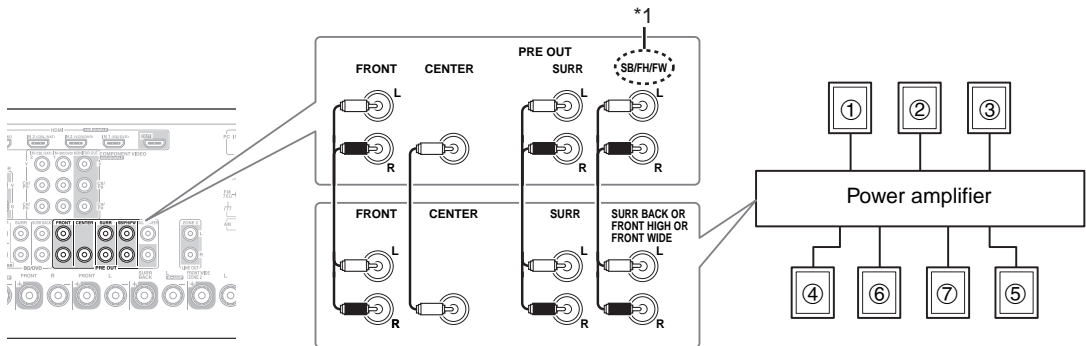

### Note

\*1 Specify "None" for the channel that you don't want to output (→ 44).

SB...Surround Back, FH...Front High, FW...Front Wide

- ① Front left speaker
- ② Center speaker
- ③ Front right speaker
- ④ Surround left speaker
- ⑤ Surround right speaker
- ⑥ Surround back/Front wide/Front high left speaker\*1
- ⑦ Surround back/Front wide/Front high right speaker\*1



## Connected image with AV components

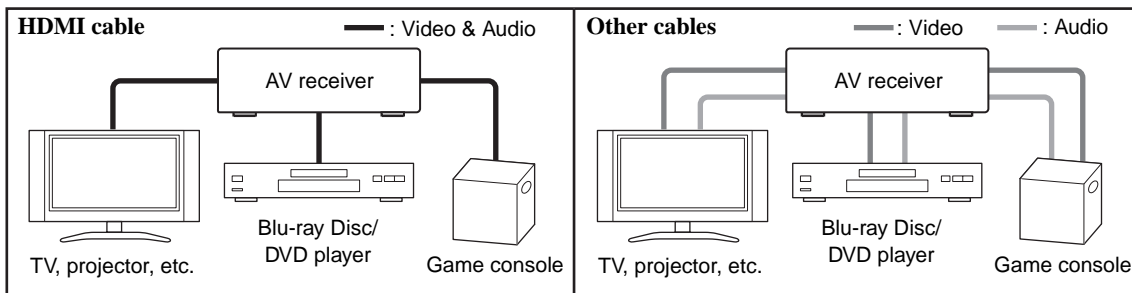

- Before making any AV connections, read the manuals supplied with your AV components.
- Don't connect the power cord until you've completed and double-checked all AV connections.
- Push plugs in all the way to make good connections (loose connections can cause noise or malfunctions).
- To prevent interference, keep audio and video cables away from power cords and speaker cables.

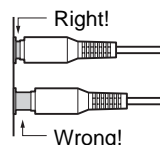

## AV Cables and Jacks

Signal	Cable	Jack	Description
Video and Audio	HDMI	HDMI	HDMI connections can carry digital video and audio.
Video	Component video	 Y Green PB/CB Blue PR/CR Red	Component video separates the luminance (Y) and color difference signals (PB/CB, PR/CR), providing the best picture quality (some TV manufacturers label their component video sockets slightly differently).
	Analog RGB		This is a conventional analog interface to connect a PC and a display device (also called D-Sub or D-subminiature).
	S-Video		S-Video separates the luminance and color signals and provides better picture quality than composite video.
	Composite video	Yellow	Composite video is commonly used on TVs, VCRs, and other video equipment.
Audio	Optical digital audio	OPTICAL	Optical digital connections allow you to enjoy digital sound such as PCM*, Dolby Digital or DTS. The audio quality is the same as coaxial.
	Coaxial digital audio	COAXIAL Orange	Coaxial digital connections allow you to enjoy digital sound such as PCM*, Dolby Digital or DTS. The audio quality is the same as optical.
	Analog audio (RCA)	 L White R Red	Analog audio connections (RCA) carry analog audio.
	1/8" (3.5 mm) Stereo mini plug		This cable carries analog audio.
	Multichannel analog audio (RCA)	 FRONT CENTER SURR (R/L) RCL SURWOOPER BOWOVD	This cable carries multichannel analog audio and is typically used to connect DVD players with a 7.1-channel analog audio output. Several standard analog audio cables can be used instead of a multichannel cable.

\* Available sampling rate for PCM input signal is 32/44.1/48/88.2/96 kHz. Even 176.4/192 kHz is effective in case of the HDMI connection.

### Note

- The AV receiver does not support SCART plugs.
- The AV receiver's optical digital jacks have shutter-type covers that open when an optical plug is inserted and close when it's removed. Push plugs in all the way.

### Caution

- To prevent shutter damage, hold the optical plug straight when inserting and removing.

## Connecting Your Components with HDMI

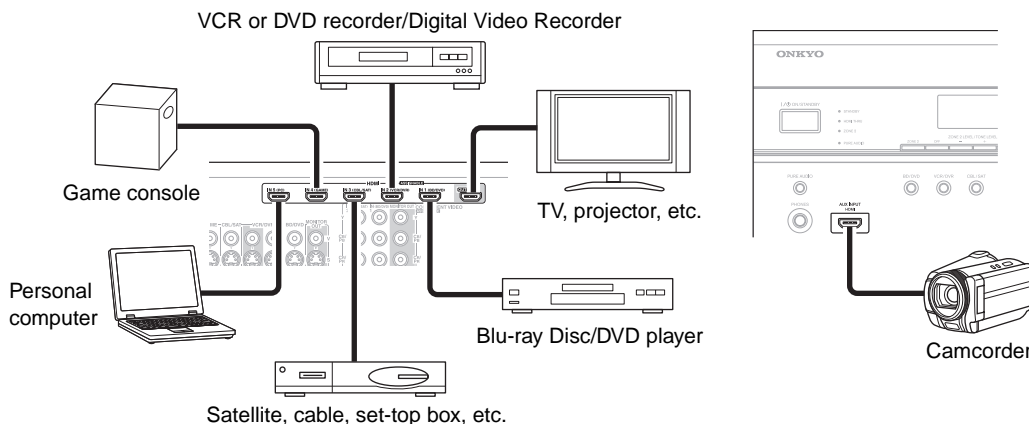

Connect your components to the appropriate jacks. The default input assignments are shown below.

✓: Assignment can be changed (→ 42).

Jack	Signal	Components	Assignable	
Input	HDMI IN 1	Audio/Video	Blu-ray Disc/DVD player	✓
	HDMI IN 2		VCR or DVD recorder/Digital Video Recorder	✓
	HDMI IN 3		Satellite, cable, set-top box, etc.	✓
	HDMI IN 4		Game console	✓
	HDMI IN 5		Personal computer	✓
	AUX INPUT HDMI		Camcorder	
Output	HDMI OUT	TV, projector, etc.		

Refer to “About HDMI” (→ 88) and “Using an RIHD-compatible TV, Player, or Recorder” (→ 89).

### ■ Audio return channel (ARC) function

Audio return channel (ARC) function enables an HDMI capable TV to send the audio stream to the **HDMI OUT** of the AV receiver. To use this function, you must select the **TV/CD** input selector.

- To use ARC function, you must select the **TV/CD** input selector, your TV must support ARC function and “**HDMI Control (RIHD)**” is set to “**On**” (→ 54).

#### Tip

- To listen to audio received by the **HDMI IN** jacks through your TV’s speakers:
  - Set the “**TV Control**” setting to “**On**” (→ 55) for an **RIHD**-compatible TV.
  - Set the “**Audio TV Out**” setting to “**On**” (→ 54) when the TV is not compatible with **RIHD** or the “**TV Control**” setting to “**Off**”.
  - Set your Blu-ray Disc/DVD player’s HDMI audio output setting to PCM.
  - To listen to TV audio through the AV receiver, see “Connecting Your Components” (→ 19).

#### Note

- When listening to an HDMI component through the AV receiver, set the HDMI component so that its video can be seen on the TV screen (on the TV, select the input of the HDMI component connected to the AV receiver). If the TV power is off or the TV is set to another input source, this may result in no sound from the AV receiver or the sound may be cut off.
- When the “**Audio TV Out**” setting is set to “**On**” (→ 54) to hear from your TV’s speakers, by controlling the AV receiver’s volume, the sound will be output from the AV receiver’s speakers, too. When the “**TV Control**” setting is set to “**On**” (→ 55) to hear from speakers of **RIHD**-compatible TV, by controlling the AV receiver’s volume, the AV receiver’s speakers will produce sound while the TV’s speakers are muted. To stop the AV receiver’s speakers producing sound, change the settings, change your TV’s settings, or turn down the AV receiver’s volume.

## Connecting Your Components

The on-screen setup menus appear only on a TV that is connected to the **HDMI OUT**. If your TV is connected to the **MONITOR OUT V**, **MONITOR OUT S** or the **COMPONENT VIDEO MONITOR OUT**, use the AV receiver's display when changing settings.

Front



Rear

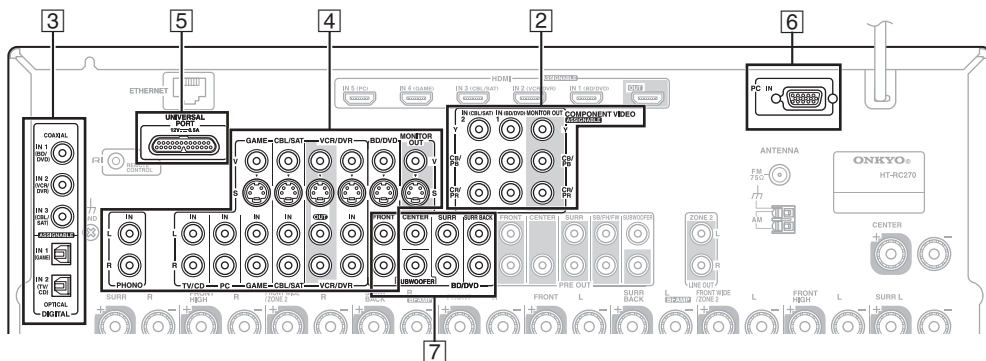

Connect your components to the appropriate jacks. The default input assignments are shown below.

✓: Assignment can be changed (→ 43).

No.	Jack	Signal	Components	Assignable		
1	AUX INPUT	LINE IN	Analog audio	Portable audio player		
		VIDEO	Composite video	Camcorder, etc		
		AUDIO L/R	Analog audio			
2	COMPONENT VIDEO	IN 1 (BD/DVD)	Component video	Blu-ray Disc/DVD player	✓	
		IN 2 (CBL/SAT)		Satellite, cable, set-top box, etc.	✓	
		MONITOR OUT		TV, projector, etc.		
3	DIGITAL	COAXIAL	IN 1 (BD/DVD)	Digital audio	Blu-ray Disc/DVD player	✓
			IN 2 (VCR/DVR)		VCR or DVD recorder/digital video recorder	✓
			IN 3 (CBL/SAT)		Satellite, cable, set-top box, etc.	✓
	OPTICAL	IN 1 (GAME)		Game console	✓	
		IN 2 (TV/CD)		TV, CD player	✓	
4	MONITOR OUT		Composite video and S-Video	TV, projector, etc.		
		BD/DVD IN	Analog audio, composite video and S-Video	Blu-ray Disc/DVD player		
		VCR/DVR IN		VCR or DVD recorder/digital video recorder		
		CBL/SAT IN		Satellite, cable, set-top box, etc.		
		GAME IN		Game console		
		PC IN	Analog audio	Personal computer		
		TV/CD IN		TV, CD player, cassette tape deck, MD, CD-R, Turntable*1		
PHONO IN		Turntable*1				
5	UNIVERSAL PORT	Analog audio/video	Universal port optional dock (UP-A1 etc.)			
6	PC IN	Analog RGB	Personal computer	*2		
7	Multichannel input	Analog audio	DVD player, DVD-Audio or Super Audio CD-capable player, or an MPEG decoder	*3		

## Note

- \*1 Connect a turntable (MM) that has built-in a phono preamp to **TV/CD IN** or connect it to **PHONO IN** with the phono preamp turned off. If your turntable (MM) doesn't have a phono preamp, connect to **PHONO IN**. If your turntable has a moving coil (MC) type cartridge, you'll need a commercially available MC head amp or MC transformer to connect to **PHONO IN**. See your turntable's manual for details.  
If your turntable has a ground wire, connect it to the AV receiver's **GND** screw. With some turntables, connecting the ground wire may produce an audible hum. If this happens, disconnect it.
  - \*2 When you connect your personal computer to **PC IN** and select **PC** input selector, video of the personal computer is output from **HDMI OUT**. However, because the AV receiver selects the video input in the order of HDMI > component > analog RGB, if you have assigned **HDMI IN** to the **PC** input selector, the AV receiver will output signals from **HDMI IN** in priority to **PC IN**.
  - \*3 To select the multichannel input, select the **BD/DVD** input selector and see "Audio Selector" (→ 58). To adjust the subwoofer sensitivity for the multichannel input, see "Subwoofer Input Sensitivity" (→ 43).
- The AV receiver can output audio and video signals from the **AUX INPUT** jacks to the **VCR/DVR OUT** jacks.
  - With connection [4], you can listen and record audio from the external components while you are in Zone 2. You can listen and record audio from the external components in the main room; you can listen to the audio in Zone 2 as well.
  - With connection [3], you can enjoy Dolby Digital and DTS. (To record or listen in Zone 2 as well, use [3] and [4].)

## How to record the video

With the connections described above, you cannot record the video through the AV receiver. To make a connection for video recording (→ 34).

## Connecting Onkyo RI Components

### Step 1:

Make sure that each Onkyo component is connected with an analog audio cable (connection [4] in the hookup examples) (→ 19).

### Step 2:

Make the **RI** connection (see illustration below).

### Step 3:

If you're using an RI Dock, or cassette tape deck, change the Input Display (→ 27).

With **RI** (Remote Interactive), you can use the following special functions:

### System On/Auto Power On

When you start playback on a component connected via **RI** while the AV receiver is on Standby, the AV receiver will automatically turn on and select that component as the input source.

### Direct Change

When playback is started on a component connected via **RI**, the AV receiver automatically selects that component as the input source.

### Remote Control

You can use the AV receiver's remote controller to control your other **RI**-capable Onkyo components, pointing the remote controller at the AV receiver's remote control sensor instead of the component. You must enter the appropriate remote control code first (→ 77).

## Note

- Use only **RI** cables for **RI** connections. **RI** cables are supplied with Onkyo players (DVD, CD, etc.).
- Some components have two **RI** jacks. You can connect either one to the AV receiver. The other jack is for connecting additional **RI**-capable components.
- Connect only Onkyo components to **RI** jacks. Connecting other manufacturer's components may cause a malfunction.
- Some components may not support all **RI** functions. Refer to the manuals supplied with your other Onkyo components.
- While Zone 2 is on, the System On/Auto Power On and Direct Change **RI** functions do not work.
- Do not use **RI** connections if you use HDMI Control (RIHD) (→ 54).

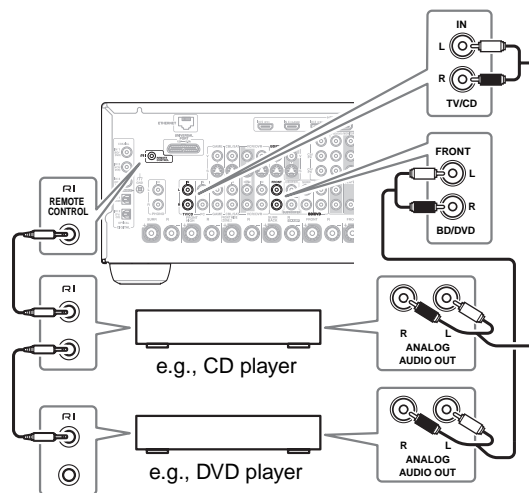

## Connecting Antenna

This section explains how to connect the supplied indoor FM antenna and AM loop antenna.

The AV receiver won't pick up any radio signals without any antenna connected, so you must connect the antenna to use the tuner.

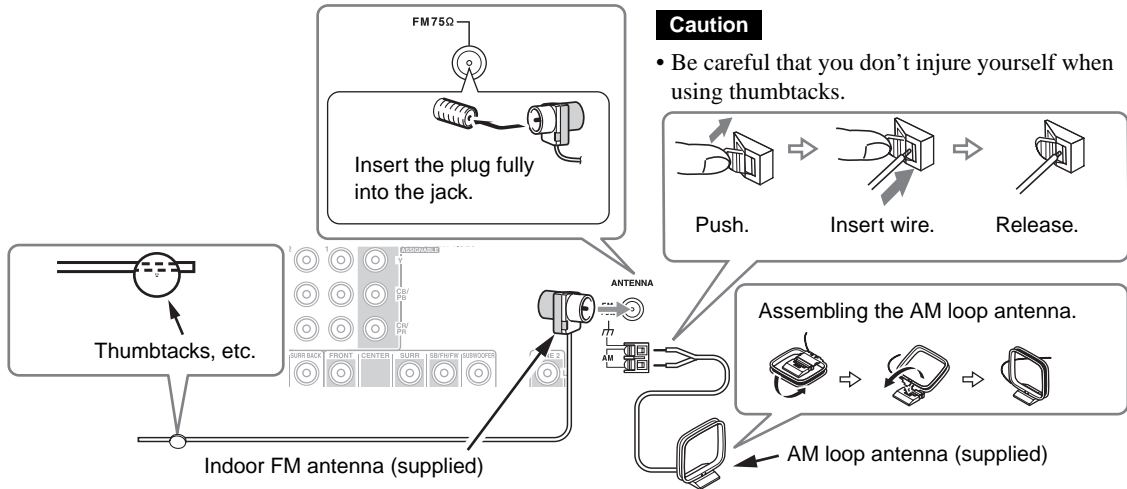

### Note

- Once your AV receiver is ready for use, you'll need to tune into a radio station and position the antenna to achieve the best possible reception.
- Keep the AM loop antenna as far away as possible from your AV receiver, TV, speaker cables, and power cords.

### Tip

- If you cannot achieve good reception with the supplied indoor FM antenna, try a commercially available outdoor FM antenna instead.
- If you cannot achieve good reception with the supplied indoor AM loop antenna, try using it with a commercially available outdoor AM antenna.

## Which Connections Should I Use?

The AV receiver supports several connection formats for compatibility with a wide range of AV equipment. The format you choose will depend on the formats supported by your components. Use the following sections as a guide.

**The on-screen setup menus appear only on a TV that is connected to the HDMI OUT. If your TV is connected to the MONITOR OUT V, MONITOR OUT S or the COMPONENT VIDEO MONITOR OUT, use the AV receiver's display when changing settings.**

### Video Connection Formats

Video component can be connected by using any one of the following video connection formats: composite video, S-Video, PC IN (Analog RGB), component video or HDMI, the latter offering the best picture quality.

**For optimal video performance, THX recommends that video signals pass through the system without upconversion (e.g., component video input through to component video output).**

**To by-pass video upconversion in the AV receiver, simultaneously press the VCR/DVR and RETURN on the AV receiver. While continuing to hold down the VCR/DVR, press RETURN to toggle until "Skip" appears on the display. Release both buttons.**

**To use the video upconversion in the AV receiver, repeat the above process until "Use" appears on the display and release the buttons.**

Video input signals flow through the AV receiver as shown, with composite video, S-Video, PC IN (Analog RGB) and component video sources all being upconverted for the HDMI output.

The composite video, S-Video and component video outputs pass through their respective input signals as they are.

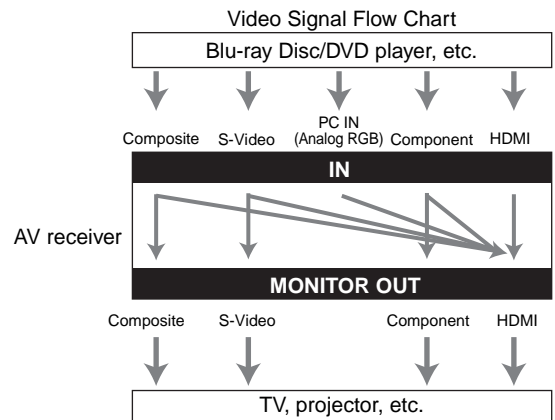

### ■ Signal Selection

If signals are present at more than one input, the inputs will be selected automatically in the following order of priority: HDMI, component video, PC IN (Analog RGB), S-Video and composite video.

However, for component video only, regardless of whether a component video signal is actually present, if a component video input is assigned to the input selector, that component video input will be selected. And if no component video input is assigned to the input selector, this will be interpreted as no component video signal being present.

In the Signal Selection Example shown on the right, video signals are present at both the S-video and composite video inputs, however, the S-video signal is automatically selected as the source and video is output by the S-Video and HDMI outputs.

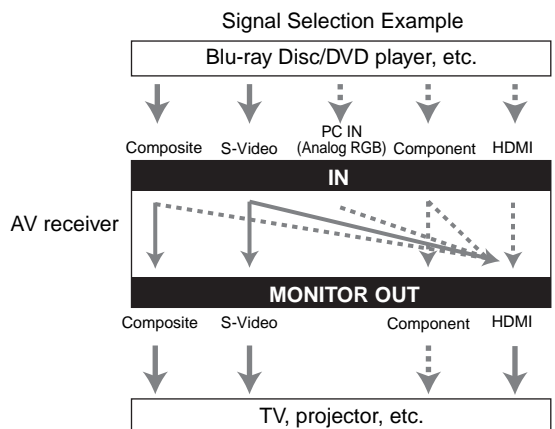

## Audio Connection Formats

Audio component can be connected by using any of the following audio connection formats: analog, optical, coaxial, analog multichannel, or HDMI.

When choosing a connection format, bear in mind that the AV receiver does not convert digital input signals for analog line outputs and vice versa. For example, audio signals connected to an optical or coaxial digital input are not output by the analog **VCR/DVR OUT**.

If signals are present at more than one input, the inputs will be selected automatically in the following order of priority: HDMI, digital, analog.

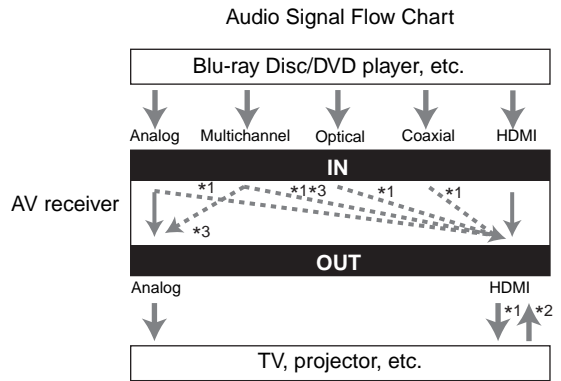

\*1 Depends on the "Audio TV Out" setting (→ 54).

\*2 This setting is available, when "Audio Return Channel" setting is set to "Auto" (→ 54), you must select the TV/CD input selector and your TV must support ARC function.

\*3 Only the front L/R channels are output.

# Turning On/Off the AV Receiver

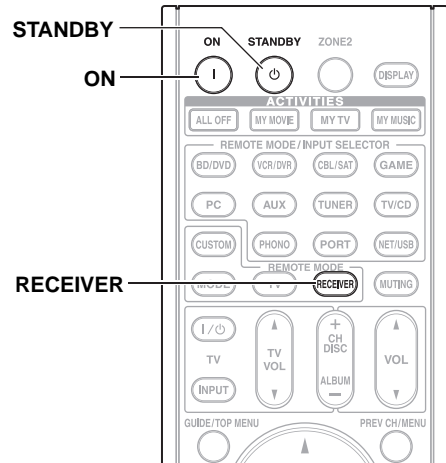
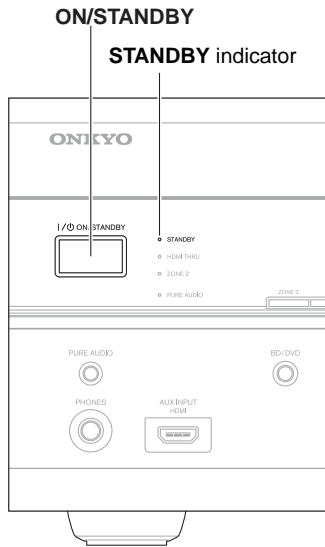

## Turning On

Press **ON/STANDBY** on the front panel.

or

Press **RECEIVER** followed by **ON** on the remote controller.

The AV receiver comes on, the display lights, and the **STANDBY** indicator goes off.

Pressing the remote controller's **ON** again will turn on any components connected via **RI**.

## Turning Off

Press **ON/STANDBY** on the front panel.

or

Press **RECEIVER** followed by **STANDBY** on the remote controller.

The AV receiver will enter Standby mode. To prevent any loud surprises when you turn on the AV receiver, always turn down the volume before you turn it off.



# Basic Operations

The on-screen setup menus appear only on a TV that is connected to the **HDMI OUT**. If your TV is connected to the **MONITOR OUT V**, **MONITOR OUT S** or the **COMPONENT VIDEO MONITOR OUT**, use the AV receiver's display when changing settings.

This manual describes the procedure using the remote controller unless otherwise specified.

## Selecting the Language Used for the Onscreen Setup Menus

You can determine the language used for the onscreen setup menus. See "Language" in the "OSD Setup" (→ 53).

## Playing the Connected Component

### ■ Operating on the AV receiver

**1** Use the input selector buttons to select the input source.

**2** Start playback on the source component.

See also:

- "Controlling Other Components" (→ 76)
- "Controlling iPod" (→ 71)
- "Listening to the Radio" (→ 32)

**3** To adjust the volume, use the **MASTER VOLUME** control.

**4** Select a listening mode and enjoy!

See also:

- "Using the Listening Modes" (→ 35)
- "Audyssey" (→ 48)

### ■ Operating with the remote controller

**1** Press **RECEIVER** followed by **INPUT SELECTOR**.

**2** Start playback on the source component.

See also:

- "Controlling Other Components" (→ 76)
- "Controlling iPod" (→ 71)
- "Listening to the Radio" (→ 32)

**3** To adjust the volume, use **VOL ▲/▼**.

**4** Select a listening mode and enjoy!

See also:

- "Using the Listening Modes" (→ 35)
- "Audyssey" (→ 48)

## Displaying Source Information

You can display various information about the current input source as follows. (Components connected to the **UNIVERSAL PORT** jack are excluded.)

Press **RECEIVER** followed by **DISPLAY** repeatedly to cycle through the available information.

### Tip

- Alternatively, you can use the AV receiver's **DISPLAY**.

The following information can typically be displayed.

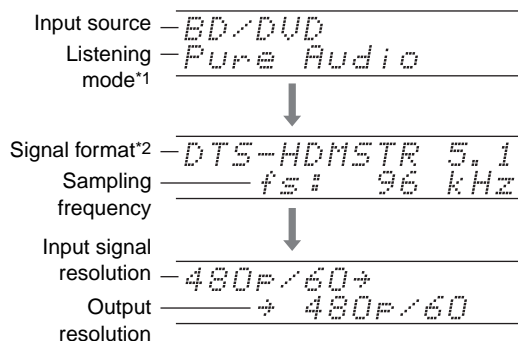

\*1 The input source is displayed with the default name even when you have entered a custom name in "Name Edit" (→ 50).

\*2 If the input signal is analog, no format information is displayed. If the input signal is PCM, the sampling frequency is displayed. If the input signal is digital but not PCM, the signal format and the number of channels is displayed. For some digital input signals, including multichannel PCM, the signal format, number of channels, and sampling frequency is displayed.

Information is displayed for about three seconds, then the previously displayed information reappears.

## Setting the Display Brightness

You can adjust the brightness of the AV receiver's display.

Press **RECEIVER** followed by **DIMMER** repeatedly to select:

- Normal + **MASTER VOLUME** indicator lights.
- Normal + **MASTER VOLUME** indicator goes off.
- Dim + **MASTER VOLUME** indicator goes off.
- Dimmer + **MASTER VOLUME** indicator goes off.

### Tip

- Alternatively, you can use the AV receiver's **DIMMER**.

## Muting the AV Receiver

You can temporarily mute the output of the AV receiver.

### Press RECEIVER followed by MUTING.

The output is muted and the **MUTING** indicator flashes on the display.

#### Tip

- To unmute, press **MUTING** again or adjust the volume.
- The Mute function is cancelled when the AV receiver is set to Standby.

## Using the Sleep Timer

With the sleep timer, you can set the AV receiver to turn off automatically after a specified period.

### Press RECEIVER followed by SLEEP repeatedly to select the required sleep time.

The sleep time can be set from 90 to 10 minutes in 10 minute steps.

The **SLEEP** indicator lights on the display when the sleep timer has been set. The specified sleep time appears on the display for about 5 seconds, then the previous display reappears.

#### Tip

- If you need to cancel the sleep timer, press **SLEEP** repeatedly until the **SLEEP** indicator goes off.
- To check the time remaining until the AV receiver sleeps, press **SLEEP**. Note that if you press **SLEEP** while the sleep time is being displayed, you'll shorten the sleep time by 10 minutes.

## Selecting Speaker Layout

You can prioritize which speakers you want to use.

### Press RECEIVER followed by SP LAYOUT repeatedly.

#### ▶ Speaker Layout: FH:

The sound from front high speakers is output by priority.

#### ▶ Speaker Layout: FW:

The sound from front wide speakers is output by priority.

#### ▶ Speaker Layout: SB:

The sound from surround back speakers is output by priority.

#### Note

- If the “**Speakers Type(Front)**” setting is set to “**Bi-Amp**” (→ 44), or Powered Zone 2 is being used (→ 69), this setting cannot be selected.
- When the listening mode that doesn't support front high, front wide or surround back speakers is used, the setting cannot be selected.

## Using the Home Menu

The Home menu provides you quick access to frequently used menus without having to go through the long standard menu. This menu enables you to change settings and view the current information.

### 1 Press RECEIVER followed by HOME.

The following information will be superimposed on the TV screen.

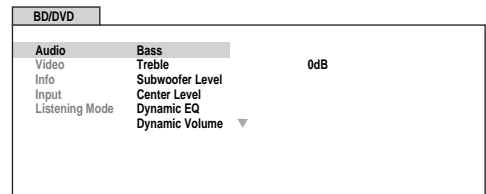

### 2 Use ▲/▼/◀/▶ to make the desired selection.

#### ■ Audio\*1

- ▶ You can change the following settings: “**Bass**”, “**Treble**”, “**Subwoofer Level**”, “**Center Level**”, “**Dynamic EQ**”, “**Dynamic Volume**”, “**Late Night**”, “**Music Optimizer**”, “**Re-EQ**”, “**Re-EQ(THX)**”, and “**Audio Selector**”.

See also:

- “**Audyssey**” (→ 48)
- “**Using the Audio Settings**” (→ 56)

#### ■ Video\*2

- ▶ You can change the following settings: “**Wide Mode**”, “**Picture Mode**”, “**Brightness**”, “**Contrast**”, “**Hue**” and “**Saturation**”.

The remote controller's **VIDEO** acts as a shortcut for this menu.

See also:

- “**Picture Adjust**” (→ 51)

#### ■ Info\*3\*4

- ▶ You can view the information of the following items: “**Audio**”, “**Video**”, and “**Tuner**”.

#### ■ Input\*4\*5

- ▶ You can select the input source while viewing the information as follows: the name of input selectors, input assignments, and radio information, and ARC function setting.

Press **ENTER** to display the current input source, followed by ▲/▼ to select the desired input source. Pressing **ENTER** again switches to the selected input source.

#### ■ Listening Mode

- ▶ You can select the listening modes that are grouped in the following categories: “**MOVIE/TV**”, “**MUSIC**”, “**GAME**”, and “**THX**”.

Use ▲/▼ to select the category and ◀/▶ to select the listening mode. Press **ENTER** to switch to the selected listening mode.

## Note

- \*1 If Pure Audio or Direct listening mode is selected, “Dynamic EQ” and “Dynamic Volume” cannot be selected.
- \*2 Only when you have selected “Custom” in the “Picture Mode” (→ 51), pressing ENTER allows you to adjust the following items via the Home menu; “Brightness”, “Contrast”, “Hue”, and “Saturation”. Press RETURN to return to the original Home menu.
- \*3 Depending on the input source and listening mode, not all channels shown here output the sound.
- \*4 When you have entered a custom name in “Name Edit” (→ 50), the input source is displayed with that name. But even if not, the component name may be displayed if the AV receiver receives it via HDMI connection (→ 18).
- \*5 For the PORT input selector, the name of Universal Port Option Dock will be displayed.

## Changing the Input Display

When you connect an **RI**-capable Onkyo component, you must configure the input display so that **RI** can work properly.

This setting can be done only from the front panel.

- 1** Press **TV/CD**, **GAME** or **VCR/DVR** so that “TV/CD”, “GAME” or “VCR/DVR” appears on the display.

TV/CD

GAME

VCR/DVR

- 2** Press and hold down **TV/CD**, **GAME** or **VCR/DVR** (about 3 seconds) to change the input display.

Repeat this step to select “MD”, “CDR”, “DOCK” or “TAPE”.

For the **TV/CD** input selector, the input display changes in this order:

TV/CD → MD → CDR  
↑ TAPE ← DOCK ← ↓

For the **GAME** input selector, the setting changes in this order:

GAME ↔ DOCK

For the **VCR/DVR** input selector, the setting changes in this order:

VCR/DVR ↔ DOCK

## Note

- **DOCK** can be selected for the **TV/CD**, **GAME** or **VCR/DVR** input selector, but not at the same time.
- Enter the appropriate remote control code before using the remote controller for the first time (→ 76).

## Using Headphones

Connect a pair of stereo headphones with a standard plug (1/4 inch or 6.3 mm) to the **PHONES** jack.

## Note

- Always turn down the volume before connecting your headphones.
- While the headphones plug is inserted in the **PHONES** jack, the Headphone indicator, speaker/channel indicator **FL** and **FR** lights. (The Powered Zone 2 speakers are not turned off.)
- When you connect a pair of headphones, the listening mode is set to Stereo, unless it's already set to Stereo, Mono, Direct, or Pure Audio.
- Only the Stereo, Direct, Pure Audio, and Mono listening modes can be used with headphones.

Using the Easy macro command in the Easy macro mode, you can sequentially operate Onkyo components with simple commands by simply pressing one button. The default actions are described below. Press **ACTIVITIES** to start the Easy macro command.

Once the AV receiver has entered the normal macro mode, all of **ACTIVITIES** will automatically switch to the normal macro mode. In this case, pressing **ALL OFF** will set only the AV receiver to Standby mode.

### Press **MY MOVIE**, **MY TV**, or **MY MUSIC**.

#### **MY MOVIE (default):**

1. The TV connected to the AV receiver is turned on.
2. The Onkyo DVD player connected to the AV receiver is turned on.
3. The AV receiver is turned on.
4. The input selector of the AV receiver is set to “**BD/DVD**”.
5. The player starts playback.\*1

#### **MY TV (default):**

1. The TV connected to the AV receiver is turned on.
2. The cable set-top box connected to the AV receiver is turned on.
3. The AV receiver is turned on.
4. The input selector of the AV receiver is set to “**CBL/SAT**”. You can enjoy cable TV.

#### **MY MUSIC (default):**

1. The Onkyo CD player connected to the AV receiver is turned on.
2. The AV receiver is turned on.
3. The input selector of the AV receiver is set to “**TV/CD**”.
4. The player starts playback.

#### Note

- Once you start the Easy macro command, you cannot use other **ACTIVITIES** during the execution. If you want to operate other components halfway, press **ALL OFF** to stop and press desired **ACTIVITIES**.

\*1 Depending on the start-up time of Blu-ray Disc/DVD player, the AV receiver may not activate this playback command. In this case, press **▶** on the remote controller.

### Press **ALL OFF**.

1. The connected component stops and turns off.
2. The AV receiver turns off.
3. The TV connected to the AV receiver turns off (Standby).\*1\*2

\*1 When **MY MUSIC** is selected, with the default settings, this will not be performed.

\*2 With some televisions, the power may not be turned off (or enter standby).

## Changing Source Component

When you want to operate the component that is not assigned as the source component, you can assign it as the source component.

### While holding down **REMOTE MODE**, press and hold down **MY MOVIE**, **MY TV**, or **MY MUSIC (about 3 seconds)**.

**ACTIVITIES** that you pressed flashes twice, indicating that the setting has been established.

#### Examples:

When you press **MY MUSIC** and want to start the Onkyo Cassette recorder, while holding down **TV/CD**, press and hold down **MY MUSIC** (about 3 seconds) flashes twice.

## Restoring Default

**1** While holding down **HOME**, press and hold down **ALL OFF** until **ALL OFF** lights (about 3 seconds).

**2** Release **HOME** and **ALL OFF** and press **ALL OFF** again.

**ALL OFF** flashes twice.

## Audyssey MultEQ® Room Correction and Speaker Setup

With the supplied calibrated microphone, Audyssey MultEQ automatically determines the number of speakers connected, their size for purposes of bass management, optimum crossover frequencies to the subwoofer (if present), and distances from the primary listening position.

Audyssey MultEQ then removes the distortion caused by room acoustics by capturing room acoustical problems over the listening area in both the frequency and time domain. The result is clear, well-balanced sound for everyone. Enabling Audyssey MultEQ allows you to also use Audyssey Dynamic EQ®, which maintains the proper octave-to-octave balance at any volume level (→ 48). Before using this function, connect and position all of your speakers.

If “Dynamic EQ” is set to “On” (→ 48), the “Equalizer” setting will be set to “Audyssey” (→ 46). On the other hand, if it is set to “Off”, the “Dynamic Volume” setting will be set to “Off” (→ 49).

It takes about 30 minutes to complete Audyssey MultEQ Room Correction and Speaker Setup for 6 positions. Total measurement time varies depending on the number of speakers.

### Using Audyssey MultEQ

Using Audyssey MultEQ to create a listening environment in your home theater that all listeners will enjoy, Audyssey MultEQ takes measurements at up to 6 positions within the listening area. Position the microphone at ear height of a seated listener with the microphone tip pointed directly at the ceiling using a tripod. Do not hold the microphone in your hand during measurements as this will produce inaccurate results.

#### ■ First measurement position

Also referred to as the Main Listening Position this refers to the most central position where one would normally sit within the listening environment. MultEQ uses the measurements from this position to calculate speaker distance, level, polarity, and the optimum crossover value for the subwoofer.

#### ■ Second–Sixth measurement positions

These are the other listening positions (i.e., the places where the other listeners will sit). You can measure up to 6 positions.

The following examples show some typical home theater seating arrangements. Choose the one that best matches yours, and position the microphone accordingly when prompted.

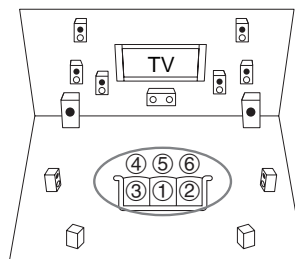

○ : Listening area      ① to ⑥: Listening position

#### Note

- Make the room as quiet as possible. Background noise and Radio Frequency Interference (RFI) can disrupt the room measurements. Close windows, televisions, radios, air conditioners, fluorescent lights, home appliances, light dimmers, or other devices. Turn off the cell phone (even if it is not in use) or place it away from all audio electronics.
- The microphone picks up test tones which played through each speaker as Audyssey MultEQ® Room Correction and Speaker Setup run.
- Audyssey MultEQ Room Correction and Speaker Setup cannot be performed while a pair of headphones is connected.

### 1 Turn on the AV receiver and the connected TV.

On the TV, select the input to which the AV receiver is connected.

### 2 Set the speaker setup microphone at the Main Listening Position ①, and connect it to the SETUP MIC jack.

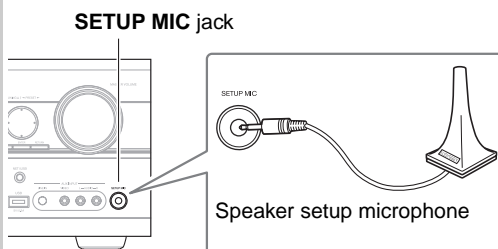

The speaker setting menu appears.

#### Note

- The on-screen setup menus appear only on a TV that is connected to the **HDMI OUT**. If your TV is connected to the **MONITOR OUT V**, **MONITOR OUT S** or the **COMPONENT VIDEO MONITOR OUT**, use the AV receiver's display when changing settings.

### 3 When you've finished making the settings, press ENTER.

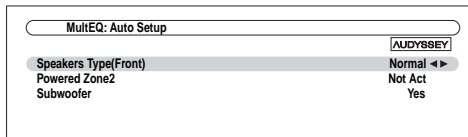

- If your front speakers are bi-amped, you must select “**Bi-Amp**” in the “**Speakers Type(Front)**” setting (→ 44). For hookup information, see “**Bi-amping the Front Speakers**” (→ 16).
- If you change “**Powered Zone2**” setting, refer to “**Setting the Powered Zone 2**” for more details (→ 69).
- If you are using a subwoofer(s), select “**Yes**” in the “**Subwoofer**” (→ 44). If not, select “**No**” and skip step 4.

### 4 If you use a powered subwoofer(s), adjust the subwoofer volume level to 75dB.

Test tones are played through the subwoofer. Use the volume control on the subwoofer.

#### Note

- If your subwoofer does not have a volume control, disregard the level displayed and press **ENTER** to proceed to the next step.
- If you set the subwoofer's volume control to its maximum and the displayed level is lower than 75 dB, leave the subwoofer's volume control at its maximum and press **ENTER** to proceed to the next step.

### 5 Press ENTER.

Audyssey MultEQ® Room Correction and Speaker Setup starts.

Test tones are played through each speaker as Audyssey MultEQ Room Correction and Speaker Setup runs. This process takes a few minutes. Please **refrain from talking** during measurements and **do not stand** between speakers and the microphone.

Do not disconnect the speaker setup microphone during Audyssey MultEQ Room Correction and Speaker Setup, unless you want to cancel the setup.

### 6 Place the setup microphone at the next position, and then press ENTER.

Audyssey MultEQ performs more measurements. This takes a few minutes.

### 7 When prompted, repeat step 6.

### 8 Use ▲/▼ to select an option, and then press ENTER.

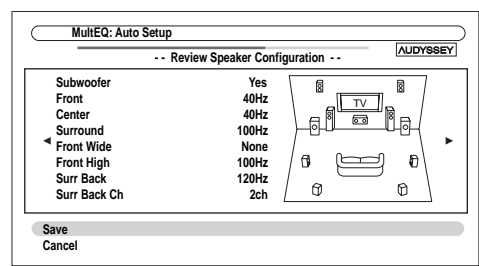

The options are:

#### ► Save:

Save the calculated settings and exit Audyssey MultEQ Room Correction and Speaker Setup.

#### ► Cancel:

Cancel Audyssey MultEQ Room Correction and Speaker Setup.

#### Note

- You can view the calculated settings for the speaker configuration, speaker distances, and speaker levels by using ◀/▶.

### 9 Disconnect the speaker setup microphone.

#### Note

- When Audyssey MultEQ Room Correction and Speaker Setup is complete, the “**Equalizer**” will be set to “**Audyssey**” (→ 46). The **Audyssey** indicator will light (→ 9).
- You can cancel Audyssey MultEQ Room Correction and Speaker Setup at any point in this procedure simply by disconnecting the setup microphone.
- Do not connect or disconnect any speakers during Audyssey MultEQ Room Correction and Speaker Setup.
- If the AV receiver is muted, it will be unmuted automatically when Audyssey MultEQ Room Correction and Speaker Setup starts.
- Changes to the room after Audyssey MultEQ Room Correction and Speaker Setup requires you run Audyssey MultEQ Room Correction and Speaker Setup again, as room EQ characteristics may have changed.

## Error Messages

While Audyssey MultEQ® Room Correction and Speaker Setup is in progress, one of the error messages below may appear.

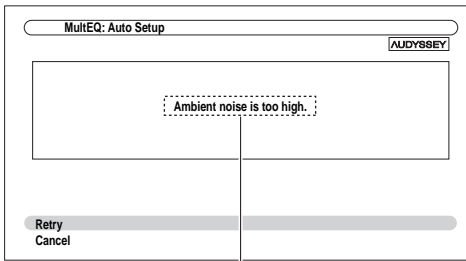

Error message

The options are:

- ▶ **Retry:**  
Try again.
- ▶ **Cancel:**  
Cancel Audyssey MultEQ Room Correction and Speaker Setup.
- **Ambient noise is too high.**  
The background noise is too loud. Remove the source of the noise and try again.
- **Speaker Matching Error!**  
The number of speakers detected was different from that of the first measurement. Check the speaker connection.
- **Writing Error!**  
This message appears if saving fails. Try saving again. If this message appears after 2 or 3 attempts, contact your Onkyo dealer.
- **Speaker Detect Error**  
This message appears if a speaker is not detected. “No” means that no speaker was detected.

### Tip

- See “Speaker Configuration” for appropriate settings (→ 13).

## Changing the Speaker Settings Manually

You can manually make changes to the settings found during Audyssey MultEQ Room Correction and Speaker Setup.

See also:

- “Speaker Configuration” (→ 44)
- “Speaker Distance” (→ 45)
- “Level Calibration” (→ 45)
- “Equalizer Settings” (→ 46)

### Note

- Please note that THX recommends any THX main speakers be set to “80Hz(THX)”. If you set up your speakers using Audyssey MultEQ Room Correction and Speaker Setup, please make sure manually that any THX speakers are set to 80 Hz (THX) crossover (→ 44).
- Sometimes due to the electrical complexities of subwoofers and the interaction with the room, THX recommends setting the level and the distance of the subwoofer manually.
- Sometimes due to interaction with the room, you may notice irregular results when setting the level and/or distance of the main speakers. If this happens, THX recommends setting them manually.

## Using a Powered Subwoofer

If you’re using a powered subwoofer and it outputs very low-frequency sound at a low volume level, it may not be detected by Audyssey MultEQ Room Correction and Speaker Setup.

If the “Subwoofer” appears on the “Review Speaker Configuration” screen as “No”, increase the subwoofer’s volume to the half-way point, set it to its highest crossover frequency, and then try running Audyssey MultEQ Room Correction and Speaker Setup again. Note that if the volume is set too high and the sound distorts, detection issues may occur, so use an appropriate volume level. If the subwoofer has a low-pass filter switch, set it to Off or Direct. Refer to your subwoofer’s instruction manual for details.

# Listening to the Radio

This section describes the procedure using the buttons on the front panel unless otherwise specified.

## Using the Tuner

With the built-in tuner you can enjoy AM and FM radio stations. You can store your favorite stations as presets for quick selection.

This model changes FM/AM frequency in 200/10kHz (or 50/9kHz) steps (→ 53).

## Listening to the Radio

Press **TUNER** to select either “AM” or “FM”.

In this example, FM has been selected.

Each time you press **TUNER**, the radio band changes between AM and FM.

Band	Frequency
FM	87.5 MHz

(Actual display depends on the country.)

## Tuning into Radio Stations

### Auto tuning mode

**1** Press **TUNING MODE** so that the **AUTO** indicator lights on the display.

**2** Press **TUNING ▲/▼**.  
Searching stops when a station is found.

When tuned into a station, the **TUNED** indicator lights. When tuned into a stereo FM station, the **FM STEREO** indicator lights on the display, as shown.

	TUNED	AUTO
FM 87.5 MHz	FM STEREO	AUTO

### Manual tuning mode

**1** Press **TUNING MODE** so that the **AUTO** indicator goes off on the display.

**2** Press and hold **TUNING ▲/▼**.  
The frequency stops changing when you release the button.  
Press the buttons repeatedly to change the frequency one step at a time.

In manual tuning mode, FM stations will be in mono.

### Tuning into weak FM stereo stations

If the signal from a stereo FM station is weak, it may be impossible to get good reception. In this case, switch to manual tuning mode and listen to the station in mono.

### Tuning into stations by frequency

You can tune into AM and FM stations directly by entering the appropriate frequency.

**1** On the remote controller, press **TUNER** repeatedly to select “AM” or “FM”, followed by **D.TUN**.

FM 87.5 MHz	AUTO
-------------	------

(Actual display depends on the country.)

**2** Within **8 seconds**, use the **number buttons** to enter the frequency of the radio station.

For example, to tune to 87.50 (FM), press **8, 7, 5, 0**.  
If you have entered the wrong number, you can retry after 8 seconds.



## Presetting FM/AM Stations

You can store a combination of up to 40 of your favorite FM/AM radio stations as presets.

### 1 Tune into the FM/AM station that you want to store as a preset.

See the previous section.

### 2 Press MEMORY.

The preset number flashes.

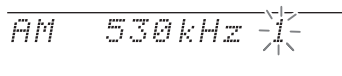

### 3 While the preset number is flashing (about 8 seconds), use PRESET ◀/▶ to select a preset from 1 through 40.

### 4 Press MEMORY again to store the station or channel.

The station or channel is stored and the preset number stops flashing.

Repeat this procedure for all of your favorite FM/AM radio stations.

#### Note

- You can name your radio presets for easy identification (→ 50). Its name is displayed instead of the band and frequency.

## Selecting Presets

To select a preset, use PRESET ◀/▶ on the AV receiver, or the remote controller's CH +/-.

#### Tip

- You can also use the remote controller's number buttons to select a preset directly.

## Deleting Presets

### 1 Select the preset that you want to delete.

See the previous section.

### 2 While holding down MEMORY, press TUNING MODE.

The preset is deleted and its number disappears from the display.

# Recording

This section explains how to record the selected input source to a component with recording capability, and how to record audio and video from different sources.

## Connecting a Recording Component

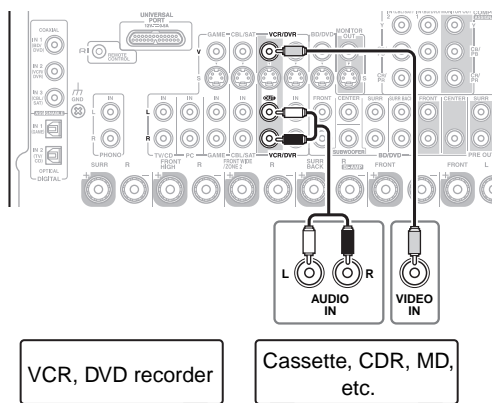

### Note

- The AV receiver must be turned on for recording. Recording is not possible while it's in Standby mode.
- If you want to record directly from your TV or playback VCR to the recording VCR without going through the AV receiver, connect the TV/VCR's audio and video outputs directly to the recording VCR's audio and video inputs. See the manuals supplied with your TV and VCR for details.
- Video signals connected to composite video inputs can be recorded only via composite video outputs. If your TV/VCR is connected to a composite video input, the recording VCR must be connected to a composite video output.
- The surround sound and DSP listening modes cannot be recorded.
- Copy-protected Blu-ray Disc/DVDs cannot be recorded.
- Sources connected to a digital input cannot be recorded. Only analog inputs can be recorded.
- DTS signals will be recorded as noise, so don't attempt analog recording of DTS CDs or LDs.
- While the listening mode is set to Pure Audio, no image is provided because the power is turned off for the video circuit. If you want to make recordings, select other listening mode.

## AV Recording

Audio sources can be recorded to a recorder (e.g., cassette deck, CDR, MD) connected to the **VCR/DVR OUT** jacks. Video sources can be recorded to a video recorder (e.g., VCR, DVD recorder) connected to the **VCR/DVR OUT** jack.

### 1 Use the input selector buttons to select the source that you want to record.

You can watch the source while recording. The AV receiver's **MASTER VOLUME** control has no effect on recording.

### 2 On your recorder, start recording.

### 3 On the source component, start playback.

If you select another input source during recording, that input source will be recorded.

## Recording Separate AV Sources

Here you can record audio and video from completely separate sources, allowing you to overdub audio onto your video recordings. This function takes advantage of the fact that when an audio-only input source (**TV/CD**, **TUNER** or **PHONO**) is selected, the video input source remains unchanged.

In the following example, audio from the CD player connected to the **TV/CD IN** and video from the camcorder connected to the **AUX INPUT VIDEO** jack are recorded by the VCR connected to the **VCR/DVR OUT** jacks.

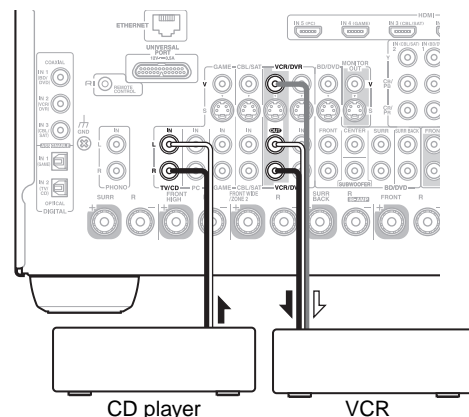
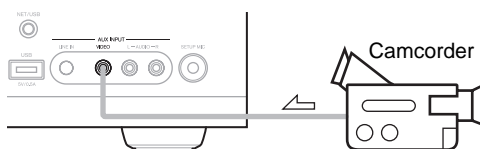

↗ : Video signal  
↘ : Audio signal

### 1 Prepare the camcorder and CD player for playback.

### 2 Prepare the VCR for recording.

### 3 Press AUX input selector.

### 4 Press TV/CD input selector.

This selects the CD player as the audio source, but leaves the camcorder as the video source.

### 5 Start recording on the VCR and start playback on the camcorder and CD player.

The video from the camcorder and the audio from the CD player are recorded by the VCR.

# Using the Listening Modes

## Selecting Listening Modes

See “About Listening Modes” for detailed information about the listening modes (→ 36).

## Listening Mode Buttons

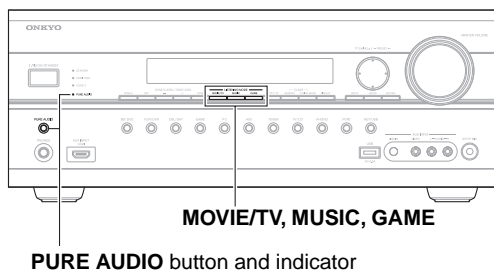
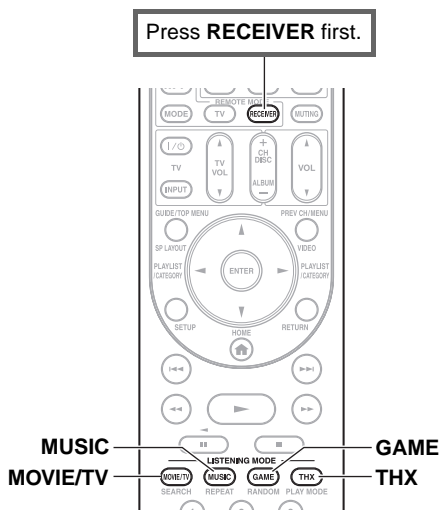

### MOVIE/TV button

This button selects the listening modes intended for use with movies and TV.

### MUSIC button

This button selects the listening modes intended for use with music.

### GAME button

This button selects the listening modes intended for use with video games.

### THX button

This button selects the THX listening modes.

### PURE AUDIO button and indicator

This button selects the Pure Audio listening mode.

When this mode is selected, the AV receiver's display and video circuitry are turned off. Only video signals input through **HDMI IN** can be output from **HDMI OUT**. The indicator lights when this mode is selected. Pressing this button again will select the previous listening mode.

- The Dolby Digital and DTS listening modes can only be selected if your Blu-ray Disc/DVD player is connected to the AV receiver with a digital audio connection (coaxial, optical, or HDMI).
- The listening modes you can select depends on the format of the input signal. To check the format, see “Displaying Source Information” (→ 25).
- While a pair of headphones is connected, you can select the following listening modes: Pure Audio, Mono, Direct, and Stereo.
- The listening modes cannot be used while you are listening to sound through your TV speakers coming from components connected to the AV receiver (“TV Sp On” appears on the front panel).

## About Listening Modes

The AV receiver's listening modes can transform your listening room into a movie theater or concert hall, with high fidelity and stunning surround sound.

### Explanatory Notes

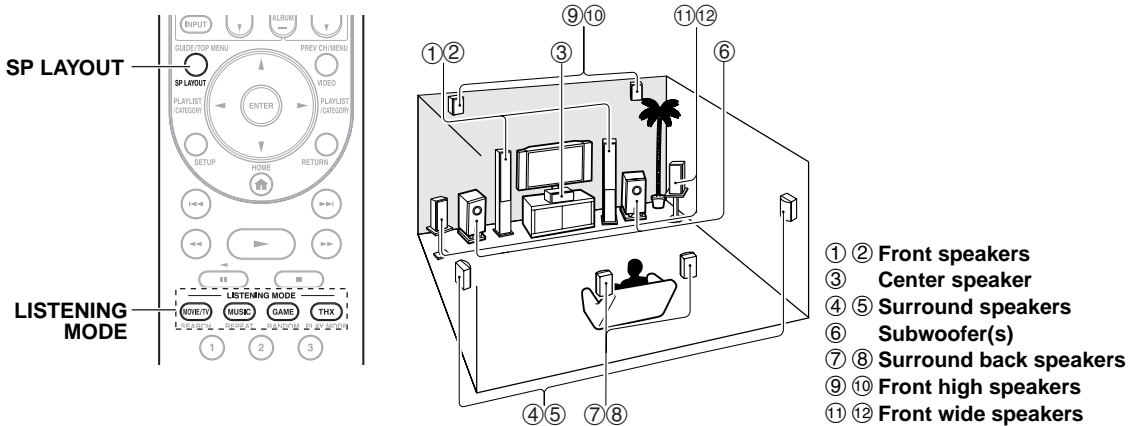

#### Input Source

The following audio formats are supported by the listening mode.

<b>MONO</b>	This is mono (monophonic) sound.
<b>STEREO</b>	This is stereo (stereophonic) sound. Two independent audio signal channels are reproduced through two speakers.
<b>5.1ch</b>	This is 5.1-channel surround sound. This surround system has five main channels of sound and a sixth subwoofer channel (called the point-one channel).
<b>7.1ch</b>	This is 7.1-channel surround sound. This is a further sound enhancement to 5.1 channel sound with two additional speakers that provide greater sound envelopment and more accurate positioning of sounds.
<b>DTS-ES</b>	This is DTS-ES surround sound. This surround system can produce a discrete or a matrix-encoded sixth channel from existing DTS 5.1 encoded material.
<b>Dolby Digital EX</b>	This is Dolby Digital EX surround sound. This provides a center back surround channel from 5.1-channel sources.

#### Speaker Layout

The illustration shows which speakers are activated in each channel. See “Speaker Configuration” for the speaker setup (→ 44).

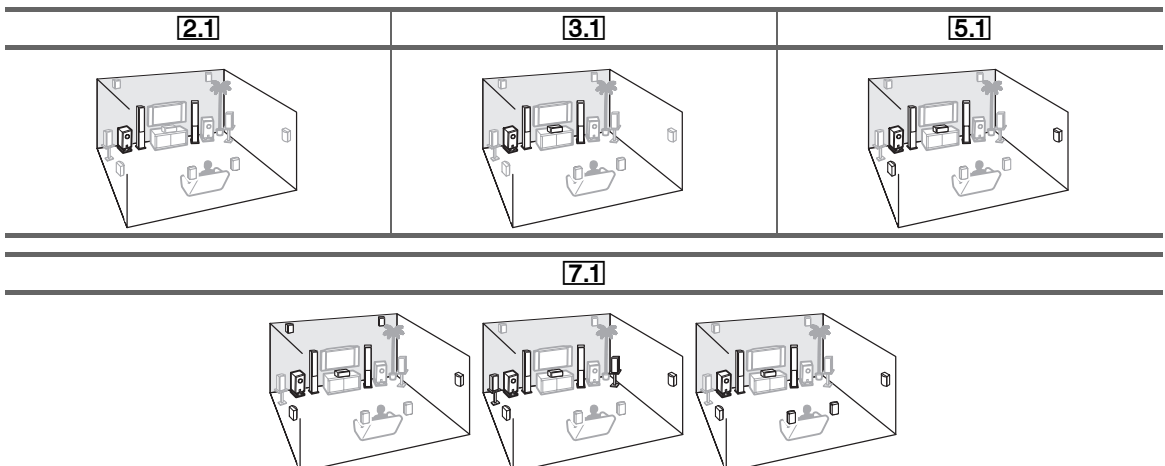

Press **RECEIVER** followed by **SP LAYOUT** repeatedly to select the speakers you want to use; front high, front wide, or surround back.

## Listening Modes

Listening Mode	Description	Input Source	Speaker Layout
<b>Pure Audio</b> <i>Pure Audio</i>	In this mode, the display and video circuitry are turned off, minimizing possible noise sources for the ultimate in high-fidelity audio reproduction. (As the video circuitry is turned off, only video signals input through <b>HDMI IN</b> can be output from <b>HDMI OUT</b> .)	<b>MONO</b> <b>STEREO</b> <b>5.1ch</b> <b>7.1ch</b>	<b>2.1</b> <b>3.1</b> <b>5.1</b> <b>7.1</b> *1
<b>Direct</b> <i>Direct</i>	In this mode, audio from the input source is output without surround-sound processing. The “ <b>Speaker Configuration</b> ” (presence of speakers), “ <b>Speaker Distance</b> ” and “ <b>A/V Sync</b> ” settings are enabled, but much of the processing set via <b>HOME</b> is disabled. See “Advanced Setup” for more details (→ <b>41</b> ).	<b>DTS-ES</b> <b>DDEX</b>	
<b>Stereo</b> <i>Stereo</i>	Sound is output by the front left and right speakers and subwoofer.	<b>MONO</b> <b>STEREO</b> <b>5.1ch</b> <b>7.1ch</b>	<b>2.1</b> <b>3.1</b> <b>5.1</b> <b>7.1</b>
<b>Mono</b> <i>Mono</i>	Use this mode when watching an old movie with a mono soundtrack, or use it with the foreign language soundtracks recorded in the left and right channels of some movies. It can also be used with DVDs or other sources containing multiplexed audio, such as karaoke DVDs.	<b>5.1ch</b> <b>7.1ch</b> <b>DTS-ES</b> <b>DDEX</b>	
<b>Multichannel</b> <i>Multich</i>	This mode is for use with PCM multichannel sources.	<b>5.1ch</b> <b>7.1ch</b>	<b>3.1</b> <b>5.1</b> <b>7.1</b>
<b>Dolby Pro Logic IIx</b> *2 <b>Dolby Pro Logic II</b> <i>PLII Movie</i> <i>PLII Music</i> <i>PLII Game</i> <i>PLIIx Movie</i> <i>PLIIx Music</i> <i>PLIIx Game</i>	<p><b>Dolby Pro Logic IIx</b> expands any 2-channel source for 7.1-channel playback. It provides a very natural and seamless surround-sound experience that fully envelops the listener. As well as music and movies, video games can also benefit from the dramatic spatial effects and vivid imaging. If you're not using any surround back speakers, <b>Dolby Pro Logic II</b> will be used instead of Dolby Pro Logic IIx.</p> <ul style="list-style-type: none"> <li>• <b>Dolby PLIIx Movie</b> Use this mode with any stereo or Dolby Surround (Pro Logic) movie (e.g., TV, DVD, VHS).</li> <li>• <b>Dolby PLIIx Music</b> Use this mode with any stereo or Dolby Surround (Pro Logic) music source (e.g., CD, radio, cassette, TV, VHS, DVD).</li> <li>• <b>Dolby PLIIx Game</b> Use this mode with video games, especially those that bear the Dolby Pro Logic II logo.</li> <li>• <b>Dolby PLIIx Movie and Dolby PLIIx Music</b> These modes use the Dolby Pro Logic IIx modes to expand 5.1-channel sources for 7.1-channel playback.</li> </ul>	<b>STEREO</b>	<b>3.1</b> <b>5.1</b> <b>7.1</b>
<b>Dolby Pro Logic IIz Height</b> <i>PLIIz Height</i>	<b>Dolby Pro Logic IIz Height</b> is designed to more effectively use existing program material when height channel speaker outputs are present. <b>Dolby Pro Logic IIz Height</b> can be used to upmix a variety of sources from movies and music, but are particularly well-suited to upmix game content.	<b>STEREO</b> <b>5.1ch</b> <b>7.1ch</b>	<b>7.1</b> *3
<b>Dolby EX</b> <i>Dolby EX</i> <i>Dolby D EX</i>	These modes expand 5.1-channel sources for 6.1/7.1-channel playback. They're especially suited to Dolby EX soundtracks that include a matrix-encoded surround back channel. The additional channel adds an extra dimension and provides an enveloping surround sound experience, perfect for rotating and fly-by sound effects.	<b>5.1ch</b> <b>DDEX</b>	<b>7.1</b> *4
<b>Dolby Digital</b> <i>Dolby D</i>	In this mode, audio from the input source is output without surround-sound processing. “ <b>Speaker Configuration</b> ” (presence of speakers), “ <b>Speaker Distance</b> ”, “ <b>A/V Sync</b> ” and much of the processing set via <b>HOME</b> are enabled. See “Advanced Setup” for more details (→ <b>41</b> ).	<b>5.1ch</b>	<b>3.1</b> <b>5.1</b> <b>7.1</b>
<b>Dolby Digital Plus</b> *5 <i>Dolby D+</i>		<b>5.1ch</b> <b>7.1ch</b>	<b>3.1</b> <b>5.1</b> <b>7.1</b> <b>3.1</b> <b>5.1</b> <b>7.1</b> *1
<b>Dolby TrueHD</b> <i>Dolby TrueHD</i>		<b>5.1ch</b> <b>7.1ch</b>	<b>3.1</b> <b>5.1</b> <b>7.1</b> <b>3.1</b> <b>5.1</b> <b>7.1</b> *1
<b>DTS</b> <i>DTS</i>		<b>5.1ch</b>	<b>3.1</b> <b>5.1</b> <b>7.1</b>

Listening Mode	Description	Input Source	Speaker Layout	
<b>DTS-HD High Resolution Audio</b> <i>DTS-HD HR</i>	(Continued from the previous page.)	<b>5.1ch</b>	<b>3.1</b> <b>5.1</b> <b>7.1</b>	
		<b>7.1ch</b>	<b>3.1</b> <b>5.1</b> <b>7.1</b> *1	
<b>DTS-HD Master Audio</b> <i>DTS-HD MSTR</i>		<b>5.1ch</b>	<b>3.1</b> <b>5.1</b> <b>7.1</b>	
		<b>7.1ch</b>	<b>3.1</b> <b>5.1</b> <b>7.1</b> *1	
<b>DTS Express</b> <i>DTS Express</i>		<b>STEREO</b> <b>5.1ch</b>	<b>3.1</b> <b>5.1</b> <b>7.1</b>	
<b>DSD*6</b> <i>DSD</i>		<b>5.1ch</b>	<b>3.1</b> <b>5.1</b> <b>7.1</b>	
<b>DTS 96/24*7</b> <i>DTS 96/24</i>		This mode is for use with DTS 96/24 sources. This is high-resolution DTS with a 96 kHz sampling rate and 24-bit resolution, providing superior fidelity. Use it with DVDs that bear the DTS 96/24 logo.	<b>5.1ch</b>	<b>3.1</b> <b>5.1</b> <b>7.1</b>
<b>DTS-ES Discrete*8</b> <i>ES Discrete</i>		This mode is for use with DTS-ES Discrete soundtracks, which use a discrete surround back channel for true 6.1/7.1-channel playback. The seven totally separate audio channels provide better spatial imaging and 360-degree sound localization, perfect for sounds that pan across the surround channels. Use it with DVDs that bear the DTS-ES logo, especially those with a DTS-ES Discrete soundtrack.	<b>DTS-ES</b>	<b>7.1</b> *4
<b>DTS-ES Matrix*8</b> <i>ES Matrix</i>		This mode is for use with DTS-ES Matrix soundtracks, which use a matrix-encoded back-channel for 6.1/7.1-channel playback. Use it with DVDs that bear the DTS-ES logo, especially those with a DTS-ES Matrix soundtrack.	<b>DTS-ES</b>	<b>7.1</b> *4
<b>DTS Neo:6</b> <i>Neo:6</i> <i>Neo:6 Cinema</i> <i>Neo:6 Music</i>		This mode expands any 2-channel source for up to 7.1-channel playback. It uses seven full-bandwidth channels of matrix decoding for matrix-encoded material, providing a very natural and seamless surround sound experience that fully envelops the listener. <ul style="list-style-type: none"> <li>• <b>Neo:6 Cinema</b> Use this mode with any stereo movie (e.g., TV, DVD, VHS).</li> <li>• <b>Neo:6 Music</b> Use this mode with any stereo music source (e.g., CD, radio, cassette, TV, VHS, DVD).</li> </ul>	<b>STEREO</b>	<b>3.1</b> <b>5.1</b> <b>7.1</b>
	This mode uses Neo:6 to expand 5.1-channel sources for 6.1/7.1-channel playback.	<b>5.1ch</b>	<b>7.1</b> *4	
<b>Audyssey DSX*9</b> <i>Audyssey DSX</i> <i>PL II Movie DSX</i> <i>PL II Music DSX</i> <i>PL II Game DSX</i> <i>Neo:6 Cin DSX</i> <i>Neo:6 Mus DSX</i>	Audyssey DSX™ is a scalable system that adds new speakers to improve surround impression. Starting with a 5.1 system Audyssey DSX first adds Wide channels for the biggest impact on envelopment. Research in human hearing has proven that information from the Wide channels is much more critical in the presentation of a realistic soundstage than then Back Surround channels found in traditional 7.1 systems. Audyssey DSX then creates a pair of Height channels to reproduce the next most important acoustical and perceptual cues. In addition to these new Wide and Height channels, Audyssey DSX applies Surround Envelopment Processing to enhance the blend between the front and surround channels.	<b>5.1ch</b> <b>7.1ch</b> <b>DTS-ES</b>	<b>7.1</b>	
	The combination of <b>Dolby Pro Logic II</b> and <b>Audyssey DSX</b> modes can be used.	<b>STEREO</b>	<b>7.1</b>	
	The combination of <b>Neo:6 Cinema/Music</b> and <b>Audyssey DSX</b> modes can be used.	<b>STEREO</b>	<b>7.1</b>	

Listening Mode	Description	Input Source	Speaker Layout
<b>THX</b> <i>THX Cinema</i> <i>THX Music</i> <i>THX Games</i> <i>THX S2 Cinema</i> <i>THX S2 Music</i> <i>THX S2 Games</i> <i>THX Surr EX</i>	<p>Founded by George Lucas, THX develops stringent standards that ensure movies are reproduced in movie theaters and home theaters just as the director intended. THX Modes carefully optimize the tonal and spatial characteristics of the soundtrack for reproduction in the home-theater environment. They can be used with 2-channel matrixed and multichannel sources. Surround back speaker output depends on the source material and the selected listening mode.</p> <ul style="list-style-type: none"> <li>• <b>THX Cinema</b> THX Cinema mode corrects theatrical soundtracks for playback in a home theater environment. In this mode, THX Loudness Plus is configured for cinema levels and Re-EQ, Timbre Matching, and Adaptive Decorrelation are active.</li> <li>• <b>THX Music</b> THX Music mode is tailored for listening to music, which is typically mastered at significantly higher levels than movies. In this mode, THX Loudness Plus is configured for music playback and only Timbre Matching is active.</li> <li>• <b>THX Games</b> THX Games mode is meant for spatially accurate playback of game audio, which is often mixed similarly to movies but in a smaller environment. THX Loudness Plus is configured for game audio levels, with Timbre Matching active.</li> </ul>	<b>5.1ch</b> <b>7.1ch</b> <b>DTS-ES</b>	<b>5.1</b> <b>7.1</b>
	The combination of <b>Dolby Pro Logic II/IIx<sup>2</sup></b> and <b>THX Cinema/Music/Games</b> modes can be used.	<b>STEREO</b> <b>5.1ch</b> <b>DDEX</b>	<b>5.1</b> <b>7.1</b>
	The combination of <b>Dolby Pro Logic IIz Height<sup>3</sup></b> and <b>THX Cinema/Music/Games</b> modes can be used.	<b>STEREO</b> <b>5.1ch</b> <b>7.1ch</b> <b>DTS-ES</b> <b>DDEX</b>	<b>7.1</b>
	The combination of <b>DTS Neo:6</b> and <b>THX Cinema/Music/Games</b> modes can be used.	<b>STEREO</b> <b>5.1ch</b> <b>7.1ch</b> <b>DDEX</b>	<b>5.1</b> <b>7.1</b>
	<ul style="list-style-type: none"> <li>• <b>THX Select2 Cinema</b> This mode expands 5.1-channel sources for 7.1-channel playback. It does this by analyzing the composition of the surround source, optimizing the ambient and directional sounds to produce the surround back channel output.</li> <li>• <b>THX Select2 Music</b> This mode is designed for use with music. It expands 5.1-channel sources for 7.1-channel playback.</li> <li>• <b>THX Select2 Games</b> This mode is designed for use with video games. It can expand 5.1-channel sources for 6.1/7.1-channel playback.</li> <li>• <b>THX Surround EX</b> This mode expands 5.1-channel sources for 6.1/7.1-channel playback. It's especially suited to Dolby Digital EX sources. THX Surround EX, also known as Dolby Digital Surround EX, is a joint development between Dolby Laboratories and THX Ltd.</li> </ul>	<b>5.1ch</b> <b>7.1ch</b>	<b>7.1</b>

## Onkyo-Original DSP Listening Modes

Listening Mode	Description	Input Source	Speaker Layout	
<b>Orchestra</b> <i>Orchestra</i>	Suitable for classical or operatic music, this mode emphasizes the surround channels in order to widen the stereo image, and simulates the natural reverberation of a large hall.	<b>MONO</b> <b>STEREO</b> <b>5.1ch</b>	<b>[5.1] [7.1]</b> <sup>*10</sup>	
<b>Unplugged</b> <i>Unplugged</i>	Suitable for acoustic instruments, vocals, and jazz, this mode emphasizes the front stereo image, giving the impression of being right in front of the stage.	<b>7.1ch</b> <b>DTS-ES</b> <b>DJEX</b>		
<b>Studio-Mix</b> <i>Studio-Mix</i>	Suitable for rock or pop music, listening to music in this mode creates a lively sound field with a powerful acoustic image, like being at a club or rock concert.			
<b>TV Logic</b> <i>TV Logic</i>	This mode adds realistic acoustics to TV shows produced in a TV studio, surround effects to the entire sound, and clarity to voices.			
<b>Game-RPG</b> <i>Game-RPG</i>	Use this mode when playing role playing game discs.			
<b>Game-Action</b> <i>Game-Action</i>	Use this mode when playing action game discs.			
<b>Game-Rock</b> <i>Game-Rock</i>	Use this mode when playing rock game discs.			
<b>Game-Sports</b> <i>Game-Sports</i>	Use this mode when playing sports game discs.			
<b>All Ch Stereo</b> <i>All Ch Stereo</i>	Ideal for background music, this mode fills the entire listening area with stereo sound from the front, surround, and surround back speakers.			<b>[3.1] [5.1] [7.1]</b> <sup>*10</sup>
<b>Full Mono</b> <i>Full Mono</i>	In this mode, all speakers output the same sound in mono, so the sound you hear is the same regardless of where you are within the listening room.			
<b>T-D (Theater-Dimensional)</b> <i>T-D</i>	With this mode you can enjoy a virtual surround sound even with only two or three speakers. This works by controlling how sounds reach the listener's left and right ears. Good results may not be possible if there's too much reverb, so we recommend that you use this mode in an environment with little or no natural reverb.		<b>[2.1] [3.1] [5.1]</b> <b>[7.1]</b>	

### Note

- \*1 Based on the audio channels contained in the source, the corresponding speakers will output the sound.
- \*2 If there are no surround back speakers, or Powered Zone 2 is being used, Dolby Pro Logic II is used.
- \*3 Surround back and front wide speakers are not supported.
- \*4 Front high and front wide speakers are not supported.
- \*5 For the Blu-ray Discs, Dolby Digital is used in a 3.1/5.1-channel speaker system.
- \*6 AV receiver can input the DSD signal from **HDMI IN**. Setting the output setting on the player side to PCM might obtain a better sound according to the player. In that case, set the output setting on the player side to PCM.
- \*7 DTS is used depending on the configuration of the AV receiver (e.g., Audyssey Dynamic EQ® is on).
- \*8 If there are no surround back speakers, DTS is used.
- \*9 • This listening mode can be selected only when all the following conditions are satisfied:
  - a. Center speaker is connected.
  - b. Either of front high or front wide speakers is connected.
  - Output can be switched between front high or front wide speakers by pressing **SP LAYOUT** [depending on the "Speaker Configuration" setting (→ 44)].
- \*10 Output can be switched between front high, front wide or surround back speakers by pressing **SP LAYOUT** [depending on the "Speaker Configuration" setting (→ 44)].
- The listening modes cannot be selected with some source formats.



# Advanced Setup

## On-screen Setup Menus

The on-screen setup menus appear only on a TV that is connected to the HDMI OUT. If your TV is connected to the MONITOR OUT V, MONITOR OUT S or the COMPONENT VIDEO MONITOR OUT, use the AV receiver's display when changing settings.

This manual describes the procedure using the remote controller unless otherwise specified.

**MENU**

- ① 1. Input/Output Assign
- ② 2. Speaker Setup
- ③ 3. Audio Adjust
- ④ 4. Source Setup
- ⑤ 5. Listening Mode Preset
- ⑥ 6. Miscellaneous
- ⑦ 7. Hardware Setup
- ⑧ 8. Remote Controller Setup
- ⑨ 9. Lock Setup

① **Input/Output Assign**  
(→ 42)

1. Input/Output Assign
1. Monitor Out
2. HDMI Input
3. Component Video Input
4. Digital Audio Input
5. Analog Audio Input

⑥ **Miscellaneous**  
(→ 53)

6. Miscellaneous
1. Volume Setup
2. OSD Setup

② **Speaker Setup**  
(→ 44)

2. Speaker Setup
1. Speaker Settings
2. Speaker Configuration
3. Speaker Distance
4. Level Calibration
5. Equalizer Settings
6. THX Audio Setup

⑦ **Hardware Setup**  
(→ 53)

7. Hardware Setup
1. Remote ID
2. Tuner
3. HDMI
4. Auto Power Down
5. Network
6. Firmware Update

③ **Audio Adjust**  
(→ 47)

3. Audio Adjust
1. Multiplex/Mono
2. Dolby
3. DTS
4. Audyssey DSX
5. Theater-Dimensional
6. LFE Level

⑧ **Remote Controller Setup**  
(→ 76)

8. Remote Controller Setup
Remote Mode Setup

④ **Source Setup** (→ 48)

4. Source Setup
1. Audyssey
2. IntelliVolume
3. A/V Sync
4. Name Edit
5. Picture Adjust

⑨ **Lock Setup** (→ 56)

9. Lock Setup
Setup

⑤ **Listening Mode Preset**  
(→ 52)

5. Listening Mode Preset
1. BD/DVD
2. VCR/DVR
3. CBL/SAT
4. GAME
5. PC
6. AUX

## Common Procedures in Setup Menu

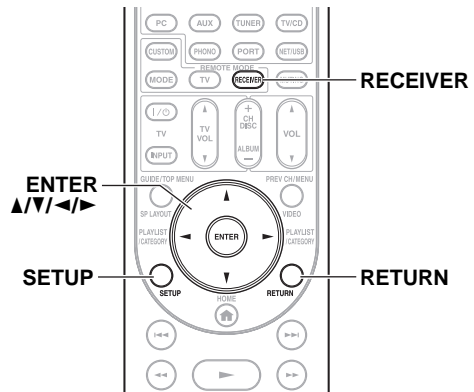

The on-screen setup menus appear on the connected TV and provide a convenient way to change the AV receiver's various settings. Settings are organized into 9 categories on the **main menu**.

Carry out the settings by using the on-screen display.

### 1 Press RECEIVER followed by SETUP.

The following menu appears.

**MENU**

1. Input/Output Assign
2. Speaker Setup
3. Audio Adjust
4. Source Setup
5. Listening Mode Preset
6. Miscellaneous
7. Hardware Setup
8. Remote Controller Setup
9. Lock Setup

#### Tip

- If the main menu doesn't appear, make sure the appropriate external input is selected on your TV.

### 2 Use ▲/▼ to select a menu, and then press ENTER.

### 3 Use ▲/▼ to select target and then press ENTER.

### 4 Use ▲/▼ to select option and use ◀/▶ to change the setting.

Press **SETUP** to close the menu.

Press **RETURN** to return to the previous menu.

#### Note

- This procedure can also be performed on the AV receiver by using **SETUP**, arrow buttons, and **ENTER**.
- During Audyssey MultEQ® Room Correction and Speaker Setup, messages, etc., that are displayed on the TV screen will appear in the Display.

## Explanatory Notes

- ① — **Main menu**      **Speaker Setup**
- ② — **Subwoofer**
- ③ — **Yes:**  
Select if a subwoofer is connected.
- No:**  
Select if no subwoofer is connected.
- ① Menu selection  
② Setting target  
③ Setting options (default setting underlined)

## Input/Output Assign

Main Menu      Input/Output Assign

### Monitor Out

You can specify the output resolution for the **HDMI OUT** and **COMPONENT VIDEO MONITOR OUT** and have the AV receiver upconvert the picture resolution as necessary to match the resolution supported by your TV.

#### Resolution

##### ▶ Through:

Select this to pass video through the AV receiver at the same resolution and with no conversion.

##### ▶ Auto:

Select this to have the AV receiver automatically convert video at resolutions not supported by your TV.

##### ▶ 480p:

Select this for 480p output and video conversion as necessary.

##### ▶ 720p:

Select this for 720p output and video conversion as necessary.

##### ▶ 1080i:

Select this for 1080i output and video conversion as necessary.

##### ▶ 1080p:

Select this for 1080p output and video conversion as necessary.

## HDMI Input

If you connect a video component to an HDMI input, you must assign that input to an input selector. For example, if you connect your Blu-ray Disc/DVD player to **HDMI IN 2**, you must assign “**HDMI2**” to the “**BD/DVD**” input selector.

If you’ve connected your TV to the AV receiver with an HDMI cable, composite video, S-video and component video sources can be upconverted\* and output by the **HDMI OUT**. You can set this for each input selector by selecting the “- - - -” option.

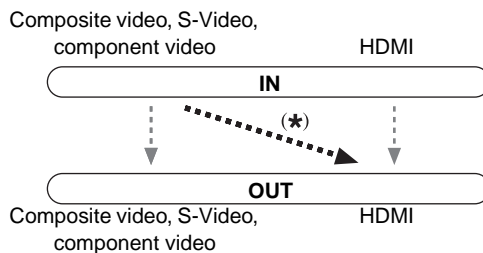

Here are the default assignments.

Input selector	Default assignment
<b>BD/DVD</b>	<b>HDMI1</b>
<b>VCR/DVR</b>	<b>HDMI2</b>
<b>CBL/SAT</b>	<b>HDMI3</b>
<b>GAME</b>	<b>HDMI4</b>
<b>PC</b>	<b>HDMI5</b>
<b>AUX</b>	<b>FRONT (Fixed)</b>
<b>TUNER</b>	<b>- - - - (Fixed)</b>
<b>TV/CD</b>	<b>- - - -</b>
<b>PHONO</b>	<b>- - - -</b>
<b>PORT</b>	<b>- - - -</b>

#### ■ **BD/DVD, VCR/DVR, CBL/SAT, GAME, PC, TV/CD, PHONO, PORT**

##### ▶ **HDMI1, HDMI2, HDMI3, HDMI4, HDMI5:**

Select the **HDMI IN** to which the video component has been connected.

##### ▶ **- - - -:**

Output composite video, S-Video, and component video sources from the **HDMI OUT**. The video output signal from the **HDMI OUT** is the one configured in “Component Video Input” (→ 43).

- “**AUX**” is used only for input from the front panel.
- Each HDMI input cannot be assigned to two input selectors or more. When **HDMI1 - HDMI5** have already been assigned, you must set first any unused input selectors to “- - - -” or you will be unable to assign **HDMI1 - HDMI5** to input selector.

### Note

- If no video component is connected to **HDMI OUT** (even if the HDMI input is assigned), the AV receiver selects the video source based on the setting of “**Component Video Input**”.
- When an **HDMI IN** is assigned to an input selector as explained here, the same **HDMI IN** will be set as a priority in the “Digital Audio Input” (→ 43). In this case, if you want to use the coaxial or optical audio input, make the selection in the Audio Selector in the Home menu (→ 26).
- “**TUNER**” selector cannot be assigned and is fixed at the “- - - -” option.
- If you connect a component (such as UP-A1 Dock that seated iPod) to **UNIVERSAL PORT** jack, you cannot assign any input to “**PORT**” selector.
- Do not assign the component connected with the HDMI input to “**TV/CD**” selector when you set “**TV Control**” setting to “**On**” (→ 55). Otherwise, appropriate CEC (Consumer Electronics Control) operation will not be guaranteed.

## Component Video Input

If you connect to a **COMPONENT VIDEO IN**, you must assign it to an input selector. For example, if you connect your Blu-ray Disc/DVD player to **COMPONENT VIDEO IN 2**, you should assign it to the “**BD/DVD**” input selector.

Here are the default assignments.

Input selector	Default assignment
<b>BD/DVD</b>	<b>IN1</b>
<b>VCR/DVR</b>	- - - - -
<b>CBL/SAT</b>	<b>IN2</b>
<b>GAME</b>	- - - - -
<b>PC</b>	- - - - -
<b>AUX</b>	- - - - -
<b>TUNER</b>	- - - - - (Fixed)
<b>TV/CD</b>	- - - - -
<b>PHONO</b>	- - - - -
<b>PORT</b>	- - - - -

### ■ **BD/DVD, VCR/DVR, CBL/SAT, GAME, PC, AUX, TV/CD, PHONO, PORT**

#### ▶ **IN1, IN2:**

Select a corresponding component video input that the video component has been connected.

#### ▶ - - - - -:

Select if you are using **HDMI OUT**, rather than the **COMPONENT VIDEO MONITOR OUT**, for the output from composite video, S-Video, and component video sources.

### Note

- If you connect a component (such as UP-A1 Dock that seated iPod) to the **UNIVERSAL PORT** jack, you cannot assign any input to “**PORT**” selector.

## Digital Audio Input

If you connect a component to a digital audio input, you must assign that input to an input selector. For example, if you connect your CD player to the **OPTICAL IN 1**, you must assign “**OPT1**” to the “**TV/CD**” input selector.

Here are the default assignments.

Input selector	Default assignment
<b>BD/DVD</b>	<b>COAX1</b>
<b>VCR/DVR</b>	<b>COAX2</b>
<b>CBL/SAT</b>	<b>COAX3</b>
<b>GAME</b>	<b>OPT1</b>
<b>PC</b>	- - - - -
<b>AUX</b>	- - - - -
<b>TUNER</b>	- - - - - (Fixed)
<b>TV/CD</b>	<b>OPT2</b>
<b>PHONO</b>	- - - - -
<b>PORT</b>	- - - - -

### ■ **BD/DVD, VCR/DVR, CBL/SAT, GAME, PC, AUX, TV/CD, PHONO, PORT**

#### ▶ **COAX1, COAX2, COAX3, OPT1, OPT2:**

Select a corresponding digital audio input that the component has been connected.

#### ▶ - - - - -:

Select if the component is connected to an analog audio input.

### Note

- When an **HDMI IN** is assigned to an input selector in “HDMI Input” (→ 42), the same **HDMI IN** will be set as a priority in this assignment. In this case, if you want to use the coaxial or optical audio input, make the selection in the Audio Selector in the Home menu.
- Available sampling rate for PCM signals from a digital input (optical and coaxial) is 32/44.1/48/88.2/96 kHz/16, 20, 24 bit.
- If you connect a component (such as UP-A1 Dock that seated iPod) to the **UNIVERSAL PORT** jack, you cannot assign any input to “**PORT**” selector.

## Analog Audio Input

Some DVD players output the LFE channel from their analog subwoofer output at 15 dB higher than normal. With this setting, you can change the AV receiver’s subwoofer sensitivity to match your DVD player.

### ■ **Subwoofer Input Sensitivity**

#### ▶ **0dB to 15dB** in 5 dB step.

### Note

- This setting only affects signals connected to the AV receiver’s multichannel input: **SUBWOOFER** jack.
- If you find that your subwoofer is too loud, try the 10 dB or 15 dB setting.

Some of the settings in this section are set automatically by Audyssey MultEQ® Room Correction and Speaker Setup function (→ 29).

Here you can check the settings made by Audyssey MultEQ Room Correction and Speaker Setup function, or set them manually, which is useful if you change one of the connected speakers after using Audyssey MultEQ Room Correction and Speaker Setup function.

### Note

- These settings are disabled when:
  - a pair of headphones is connected, or
  - the “**Audio TV Out**” setting is set to “**On**” (→ 54) and an input selector other than **HDMI** is selected.

## Speaker Settings

If you change these settings, you must run Audyssey MultEQ Room Correction and Speaker Setup again (→ 29).

If the impedance of any speaker is 4 ohms or more but less than 6, set the minimum speaker impedance to 4 ohms.

If you bi-amp the front speakers, you must change the “**Speakers Type(Front)**” setting (→ 44).

For hookup information, see “**Bi-amping the Front Speakers**” (→ 16).

### Note

- When bi-amping is used, the AV receiver is able to drive up to 5.1 speakers in the main room.
- Before you change these settings, turn down the volume.

### ■ Speaker Impedance

#### ▶ 4ohms:

Select if the impedance of any speaker is 4 ohms or more but less than 6.

#### ▶ 6ohms:

Select if the impedances of all speakers are between 6 and 16 ohms.

### ■ Speakers Type(Front)

#### ▶ Normal:

Select this if you’ve connected your front speakers normally.

#### ▶ Bi-Amp:

Select this if you’ve bi-amped your front speakers.

### Note

- Powered Zone 2 cannot be used if “**Speakers Type(Front)**” is set to “**Bi-Amp**” (→ 69).

### ■ Powered Zone2

See “**Setting the Powered Zone 2**” (→ 69).

This setting is set automatically by Audyssey MultEQ Room Correction and Speaker Setup function (→ 29).

With these settings, you can specify which speakers are connected and a crossover frequency for each speaker. Specify “**Full Band**” for speakers that can output low frequency bass sounds adequately, for example, speakers with a good sized woofer. For smaller speakers, specify a crossover frequency. Sounds below the crossover frequency will be output by the subwoofer instead of the speaker. Refer to your speaker’s manuals to determine the optimum crossover frequencies. If you set up your speakers using Audyssey MultEQ Room Correction and Speaker Setup, please make sure manually that any THX speakers are set to “**80Hz(THX)**” crossover.

### ■ Subwoofer

#### ▶ Yes:

Select if a subwoofer is connected.

#### ▶ No:

Select if no subwoofer is connected.

### ■ Front

#### ▶ Full Band

▶ **40Hz** to **80Hz(THX)** to **100Hz, 120Hz, 150Hz, 200Hz**

### Note

- If the “**Subwoofer**” setting is set to “**No**”, the “**Front**” setting is fixed at “**Full Band**”.

### ■ Center\*1, Surround\*1, Surr Back\*2\*3\*4\*5

#### ▶ Full Band

▶ **40Hz** to **80Hz(THX)** to **100Hz, 120Hz, 150Hz, 200Hz**

#### ▶ None:

Select if no speaker is connected.

### ■ Front Wide\*1\*2\*4\*6, Front High\*1\*2\*4\*5

#### ▶ Full Band

▶ **40Hz** to **80Hz(THX)** to **100Hz, 120Hz, 150Hz, 200Hz**

#### ▶ None:

Select if no speaker is connected.

### Note

- \*1 “**Full Band**” can be selected only when “**Full Band**” is selected in the “**Front**” setting.
- \*2 If the “**Surround**” setting is set to “**None**”, this setting cannot be selected.
- \*3 If the “**Surround**” setting is set to anything other than “**Full Band**”, “**Full Band**” cannot be selected here.
- \*4 If the “**Speakers Type(Front)**” setting is set to “**Bi-Amp**” (→ 44), this setting cannot be selected.
- \*5 If the Powered Zone 2 is being used (→ 69), this setting cannot be selected.
- \*6 If the “**Powered Zone 2**” setting is set to “**Act**” (→ 69), this setting cannot be selected.

## ■ Surr Back Ch

### ▶ 1ch:

Select if only one surround back speaker is connected.

### ▶ 2ch:

Select if two (left and right) surround back speakers are connected.

### Note

- If the “**Surr Back**” setting is set to “**None**” (→ 44), this setting cannot be selected.

## ■ LPF of LFE

### (Low-Pass Filter for the LFE Channel)

#### ▶ 80Hz, 90Hz, 100Hz, 120Hz

With this setting, you can specify the cutoff frequency of the LFE channel’s low-pass filter (LPF), which can be used to filter out unwanted hum. The LPF only applies to sources that use the LFE channel.

## ■ Double Bass

This setting is NOT set automatically by Audyssey MultEQ® Room Correction and Speaker Setup function (→ 29).

With the Double Bass function, you can boost bass output by feeding bass sounds from the front left, right, and center channels to the subwoofer.

### ▶ On:

Double Bass function on.

### ▶ Off(THX):

Double Bass function off.

### Note

- This function can be set only if the “**Subwoofer**” setting is set to “**Yes**”, and the “**Front**” setting is set to “**Full Band**”.
- If you’re using THX-certified speakers, select “**Off(THX)**”.

## Speaker Distance

This setting is set automatically by Audyssey MultEQ Room Correction and Speaker Setup function (→ 29).

Here you can specify the distance from each speaker to the listening position so that the sound from each speaker arrives at the listener’s ears as the sound designer intended.

## ■ Unit

### ▶ feet:

Distances can be set in feet. Range: “**0.5ft**” to “**30.0ft**” in 0.5 foot steps.

### ▶ meters:

Distances can be set in meters. Range: “**0.15m**” to “**9.00m**” in 0.15 meter steps.

## ■ Left, Front Wide Left, Front High Left, Center, Front High Right, Front Wide Right, Right, Surr Right, Surr Back Right, Surr Back Left, Surr Left, Subwoofer

- ▶ Specify the distance from the each speaker to your listening position.

### Note

- Speakers that you set to “**No**” or “**None**” in the “**Speaker Configuration**” cannot be selected (→ 44).

## Level Calibration

This setting is set automatically by Audyssey MultEQ Room Correction and Speaker Setup function (→ 29).

Here you can adjust the level of each speaker with the built-in test tone so that the volume of each speaker is the same at the listening position.

## ■ Left, Front Wide Left, Front High Left, Center\*1, Front High Right, Front Wide Right, Right, Surr Right, Surr Back Right, Surr Back Left, Surr Left

- ▶ **-12.0dB to 0.0dB** to **+12.0dB** in 0.5 dB step.

## ■ Subwoofer\*1

- ▶ **-15.0dB to 0.0dB** to **+12.0dB** in 0.5 dB step.

### Note

- Speakers that you set to “**No**” or “**None**” in the “**Speaker Configuration**” cannot be selected (→ 44).
- The speakers cannot be calibrated while the AV receiver is muted.
- The test tone is output at the standard level for THX, which is 0 dB (absolute volume setting 82). If you normally listen at volume settings below this, be careful because the test tone will be much louder.

\*1 For the center speaker and subwoofer, the level settings made by using the Home menu are saved (→ 26).

### Tip

- If you’re using a handheld sound level meter, adjust the level of each speaker so that it reads 75 dB SPL at the listening position, measured with C-weighting and slow reading.

## Equalizer Settings

This setting is set automatically by Audyssey MultEQ® Room Correction and Speaker Setup function (→ 29).

With the Equalizer settings, you can adjust the tone of speakers individually with a 7-band equalizer. The volume of each speaker can be set (→ 45).

### ■ Equalizer

#### ▶ Manual:

You can adjust the equalizer for each speaker manually. If you selected “Manual”, continue with this procedure.

**1** Press **▼** to select “Channel”, and then use **◀/▶** to select a speaker.

**2** Use **▲/▼** to select a frequency, and then use the **◀/▶** to adjust the level at that frequency. The volume at each frequency can be adjusted from **-6dB** to **0dB** to **+6dB** in 1 dB steps.

#### Note

- You can select: “63Hz”, “160Hz”, “400Hz”, “1000Hz”, “2500Hz”, “6300Hz”, or “16000Hz”. And for the subwoofer, “25Hz”, “40Hz”, “63Hz”, “100Hz”, or “160Hz”.
- While the Direct or Pure Audio listening mode is selected, the equalizer settings have no effect.

#### Tip

- Low frequencies (e.g., 63Hz) affect bass sounds; high frequencies (e.g., 16000Hz) affect treble sounds.

**3** Use **▲** to select “Channel”, and then use **◀/▶** to select another speaker.

Repeat steps 1 and 2 for each speaker.

You cannot select speakers that you set to “No” or “None” in the “Speaker Configuration” (→ 44).

#### ▶ Audyssey:

This is selected automatically by Audyssey MultEQ Room Correction and Speaker Setup function. The **Audyssey** indicator will light (→ 9) and “Dynamic EQ” and “Dynamic Volume” become available (→ 48).

#### ▶ Off:

Tone off, response flat.

## THX Audio Setup

With the “Surr Back Speaker Spacing” setting, you can specify the distance between your surround back speakers. If you’re using a THX-certified subwoofer, set the “THX Ultra2/Select2 Subwoofer” setting to “Yes”. You can then apply THX’s Boundary Gain Compensation (BGC) to compensate the perceived exaggeration of low frequencies for listeners sitting very close to a room boundary (i.e., wall).

You can also set the THX Loudness Plus. When the “Loudness Plus” is set to “On”, it is possible to enjoy even subtle nuances of audio expression at low volume. This result is only available when the THX listening mode is selected.

### ■ Surr Back Speaker Spacing

#### ▶ < 1ft (< 0.3m):

Select this if your surround back speakers are between 0 and 1 foot (0–30 cm) apart.

#### ▶ 1ft - 4ft (0.3m - 1.2m):

Select this if your surround back speakers are between 1 and 4 feet (0.3–1.2 m) apart.

#### ▶ > 4ft (> 1.2m):

Select this if your surround back speakers are more than 4 feet (1.2 m) apart.

#### Note

- Cannot be set if “Surr Back Ch” is set to “1ch” (→ 45), “Speakers Type(Front)” is set to “Bi-Amp” (→ 44), “Surr Back” is set to “None” (→ 44), or Powered Zone 2 is being used (→ 69).

### ■ THX Ultra2/Select2 Subwoofer

#### ▶ No:

Select this if you do not have a THX-certified subwoofer.

#### ▶ Yes:

Select this if you have a THX-certified subwoofer.

#### Note

- If the “Subwoofer” setting is set to “No”, this setting cannot be selected (→ 44).

### ■ BGC

#### ▶ Off:

Select this to turn off BGC.

#### ▶ On:

Select this to turn on BGC.

#### Note

- This setting is only available if “THX Ultra2/Select2 Subwoofer” is set to “Yes”.

### ■ Loudness Plus

#### ▶ Off:

Select this to turn off Loudness Plus.

#### ▶ On:

Select this to turn on Loudness Plus.

## ■ Preserve THX Settings

### ▶ **Yes:**

Audyssey Dynamic EQ®/  
Audyssey Dynamic Volume® will not be active in THX listening mode.

### ▶ **No:**

Audyssey Dynamic EQ/  
Audyssey Dynamic Volume will be active in THX listening mode depending on the setting.

### Note

- This setting is fixed at “Yes” if “Loudness Plus” is set to “On”.

### THX Loudness Plus

THX Loudness Plus is a new volume control technology featured in THX Ultra2 Plus™ and THX Select2 Plus™ Certified receivers. With THX Loudness Plus, home theater audiences can now experience the rich details in a surround mix at any volume level. A consequence of turning the volume below Reference Level is that certain sound elements can be lost or perceived differently by the listener. THX Loudness Plus compensates for the tonal and spatial shifts that occur when the volume is reduced by intelligently adjusting ambient surround channel levels and frequency response. This enables users experience the true impact of soundtracks regardless of the volume setting. THX Loudness Plus is automatically applied when listening in any THX listening mode. The new THX Cinema, THX Music, and THX Games modes are tailored to apply the proper THX Loudness Plus settings for each type of content.

## Audio Adjust

Main menu

Audio Adjust

With the Audio Adjust functions and settings, you can adjust the sound and listening modes as you like.

## Multiplex/Mono

### ■ Multiplex

This setting determines which channel of a stereo multiplex source is output. Use it to select audio channels or languages with multiplex sources, multilingual TV broadcasts, and so on.

#### Input Channel

##### ▶ **Main:**

The main channel is output.

##### ▶ **Sub:**

The sub channel is output.

##### ▶ **Main/Sub:**

Both the main and sub channels are output.

### ■ Mono

This setting specifies the channel to be used for playing any 2-channel digital source such as Dolby Digital, or 2-channel analog/PCM source in the Mono listening mode.

## Input Channel

### ▶ **Left + Right:**

Both the left and right channels are output.

### ▶ **Left:**

Only the left channel is output.

### ▶ **Right:**

Only the right channel is output.

## Output Speaker

### ▶ **Center:**

Mono audio is output by the center speaker.

### ▶ **Left / Right:**

Mono audio is output by the front left and right speakers.

This setting determines which speakers output mono audio when the Mono listening mode is selected.

### Note

- If the “Center” setting is set to “None” (→ 44), this setting is fixed at “Left / Right”.

## Dolby

### ■ PLIIx Music (2ch Input)

These settings apply to only 2-channel stereo sources.

If you're not using any surround back speakers, these settings apply to Dolby Pro Logic II, not Dolby Pro Logic IIX.

#### Panorama

##### ▶ **On:**

Panorama function on.

##### ▶ **Off:**

Panorama function off.

With this setting, you can broaden the width of the front stereo image when using the Dolby Pro Logic IIX Music listening mode.

#### Dimension

##### ▶ **-3 to 0 to +3**

With this setting, you can move the sound field forward or backward when using the Dolby Pro Logic IIX Music listening mode. Higher settings move the sound field backward. Lower settings move it forward.

If the stereo image feels too wide, or there's too much surround sound, move the sound field forward to improve the balance. Conversely, if the stereo image feels like it's in mono, or there's not enough surround sound, move it backward.

#### Center Width

##### ▶ **0 to 3 to 7**

With this setting, you can adjust the width of the sound from the center speaker when using the Dolby Pro Logic IIX Music listening mode. Normally, if you're using a center speaker, the center channel sound is output by only the center speaker. (If you're not using a center speaker, the center channel sound will be distributed to the front left and right speakers to create a phantom center). This setting controls the front left, right, and center mix, allowing you to adjust the weight of the center channel sound.

## ■ PLIIz Height Gain

The Height Gain Control in Dolby Pro Logic IIz enables the listener to select how much gain is applied to the front high speakers. There are three settings, “**Low**”, “**Mid**” and “**High**”, and the front high speakers are accentuated in that order. While “**Mid**” is the default listening setting, the listener may adjust the Height Gain Control to their personal preference.

### ▶ **Low:**

Low PLIIz Height Gain becomes active.

### ▶ **Mid:**

Medium PLIIz Height Gain becomes active.

### ▶ **High:**

High PLIIz Height Gain becomes active.

## Note

- If the “**Front High**” settings is set to “**None**” (→ 44), this setting cannot be selected.

## ■ Dolby EX

This setting determines how Dolby EX encoded signals are handled. This setting is unavailable if no surround back speakers are connected. This setting is effective with Dolby Digital, Dolby Digital Plus and Dolby TrueHD only.

### ▶ **Auto:**

If the source signal contains a Dolby EX flag, the Dolby EX or THX Surround EX listening mode is used.

### ▶ **Manual:**

You can select any available listening mode.

## Note

- If the “**Surr Back**” setting is set to “**None**” (→ 44), this setting cannot be selected.
- If the “**Front High**” or “**Front Wide**” setting is enabled (→ 44), this setting is fixed at “**Manual**”.

## DTS

### ■ Neo:6 Music

#### Center Image

##### ▶ 0 to 2 to 5

The DTS Neo:6 Music listening mode creates 6-channel surround sound from 2-channel stereo sources. With this setting, you can specify by how much the front left and right channel output is attenuated in order to create the center channel.

Setting a value “0” in the middle is set to hear a sound. Sound is spread in left and right (the outside) so that the set value is made big. Please adjust by liking.

## Audyssey DSX™

### ■ Soundstage

##### ▶ -3dB to **Reference** to +3dB

With this setting, you can adjust the soundstage when using Audyssey DSX™.

## Note

- If the “**Center**” setting is set to “**None**”, or both “**Front High**” and “**Front Wide**” settings are set to “**None**” (→ 44), this setting cannot be selected.

## Theater-Dimensional

### ■ Listening Angle

#### ▶ **Wide:**

Select if the listening angle is 40 degrees.

#### ▶ **Narrow:**

Select if the listening angle is 20 degrees.

With this setting, you can optimize the Theater-Dimensional listening mode by specifying the angle of the front left and right speakers relative to the listening position. Ideally, the front left and right speakers should be equidistant from the listening position and at an angle close to one of the two available settings.

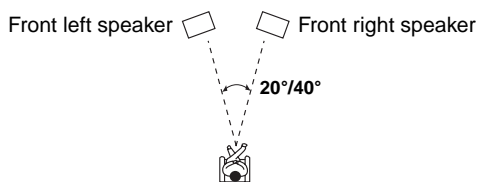

## LFE Level

### ■ Dolby Digital\*1, DTS\*2, Multich PCM, Dolby TrueHD, DTS-HD Master Audio, DSD\*3

#### ▶ -∞dB, -20dB, -10dB, or 0dB

With these settings, you can set the level of the LFE (Low Frequency Effects) channel individually for each input sources.

If you find that low-frequency effects are too loud when using one of these sources, change the setting to -20 dB or -∞ dB.

\*1 Dolby Digital and Dolby Digital Plus sources.

\*2 DTS and DTS-HD High Resolution Audio sources.

\*3 DSD (Super Audio CD) sources.

## Source Setup

Items can be set individually for each input selector.

### Preparation

Press the input selector buttons to select an input source.

### Main menu

### Source Setup

## Audyssey

When Audyssey MultEQ® Room Correction and Speaker Setup is complete, the “**Equalizer**” (→ 46) will be set to “**Audyssey**” and the “**Dynamic EQ**” will be set to “**On**”.

### ■ Dynamic EQ

#### ▶ **Off:**

Audyssey Dynamic EQ® off.

#### ▶ **On:**

Audyssey Dynamic EQ on.

The **Dynamic EQ** indicator will light (→ 9).



With Audyssey Dynamic EQ®, you can enjoy great sound even when listening at low volume levels.

Audyssey Dynamic EQ solves the problem of deteriorating sound quality as volume is decreased by taking into account human perception and room acoustics. It does so by selecting the correct frequency response and surround volume levels moment-by-moment so that the content sounds the way it was created at any volume level — not just at reference level.

#### Note

- If Pure Audio or Direct listening mode is selected, this setting cannot be selected.

### ■ Reference Level

#### Audyssey Dynamic EQ Reference Level Offset

##### ▶ 0dB:

It should be used when listening to movies.

##### ▶ 5dB:

Select this setting for content that has a very wide dynamic range, such as classical music.

##### ▶ 10dB:

Select this setting for jazz or other music that has a wider dynamic range. This setting should also be selected for TV content as that is usually mixed at 10 dB below film reference.

##### ▶ 15dB:

Select this setting for pop/rock music or other program material that is mixed at very high listening levels and has a compressed dynamic range.

Movies are mixed in rooms calibrated for film reference. To achieve the same reference level in a home theater system each speaker level must be adjusted so that -30 dBFS band-limited (500 Hz to 2000 Hz) pink noise produces 75 dB sound pressure level at the listening position. A home theater system automatically calibrated by Audyssey MultEQ® will play at reference level when the master volume control is set to the 0 dB position. At that level you can hear the mix as the mixers heard it.

Audyssey Dynamic EQ is referenced to the standard film mix level. It makes adjustments to maintain the reference response and surround envelopment when the volume is turned down from 0 dB. However, film reference level is not always used in music or other non-film content. Audyssey Dynamic EQ Reference Level Offset provides three offsets from the film level reference (5 dB, 10 dB, and 15 dB) that can be selected when the mix level of the content is not within the standard.

#### Note

- If “Dynamic EQ” setting is set to “Off”, this setting cannot be selected.

### ■ Dynamic Volume

#### ▶ Off:

Audyssey Dynamic Volume® off.

#### ▶ Light:

Light Compression Mode becomes active.

#### ▶ Medium:

Medium Compression Mode becomes active.

#### ▶ Heavy:

Heavy Compression Mode becomes active. This setting affects volume the most, causing all sounds to be of equal loudness.

#### Note

- Even if you have selected other than “Audyssey” in “Equalizer” setting after performing Audyssey MultEQ Room Correction and Speaker Setup, selecting “On” in the “Dynamic EQ” will change the “Equalizer” setting to “Audyssey” (→ 46).
- If you would like to use Audyssey Dynamic Volume, when using THX listening modes, set “Loudness Plus” setting to “Off” (→ 46) and set “Preserve THX Settings” setting to “No” (→ 47).
- When “Dynamic Volume” is set to effective, “Equalizer” is set to “Audyssey” (→ 46) and “Dynamic EQ” is set to “On”. When “Dynamic EQ” is set to “Off”, “Dynamic Volume” becomes “Off” automatically.
- When “Dynamic Volume” is set to effective, the Dynamic Vol indicator will light (→ 9).
- If Pure Audio or Direct listening mode is selected, this setting cannot be selected.

Audyssey MultEQ then removes the distortion caused by room acoustics by capturing room acoustical problems over the listening area in both the frequency and time domain. The result is clear, well-balanced sound for everyone. Enabling Audyssey MultEQ allows you to also use Audyssey Dynamic EQ, which maintains the proper octave-to-octave balance at any volume level.

Before using this function, connect and position all of your speakers.

#### About Audyssey Dynamic EQ

Audyssey Dynamic EQ solves the problem of deteriorating sound quality as volume is decreased by taking into account human perception and room acoustics. Dynamic EQ selects the correct frequency response and surround levels moment-by-moment at any user-selected volume setting. The result is bass response, tonal balance, and surround impression that remain constant despite changes in volume. Dynamic EQ combines information from incoming source levels with actual output sound levels in the room, a prerequisite for delivering a loudness correction solution.

Audyssey Dynamic EQ works in tandem with Audyssey MultEQ to provide well-balanced sound for every listener at any volume level.

### About Audyssey Dynamic Volume®

Audyssey Dynamic Volume solves the problem of large variations in volume level between television programs, commercials, and between the soft and loud passages of movies. Dynamic Volume looks at the preferred volume setting by the user and then monitors how the volume of program material is being perceived by listeners in real time to decide whether an adjustment is needed. Whenever necessary, Dynamic Volume makes the necessary rapid or gradual adjustments to maintain the desired playback volume level while optimizing the dynamic range. Audyssey Dynamic EQ® is integrated into Dynamic Volume so that as the playback volume is adjusted automatically, the perceived bass response, tonal balance, surround impression, and dialog clarity remain the same whether watching movies, flipping between television channels, or changing from stereo to surround sound content.

## IntelliVolume

### IntelliVolume

▶ **-12dB** to **0dB** to **+12dB** in 1 dB steps.

With IntelliVolume, you can set the input level for each input selector individually. This is useful if one of your source components is louder or quieter than the others.

Use ◀▶ to set the level.

If a component is noticeably louder than the others, use ◀ to reduce its input level. If it's noticeably quieter, use ▶ to increase its input level.

## A/V Sync

### A/V Sync

▶ **0ms** to **250ms** in 5 ms steps.

When using your DVD player's progressive scanning function, you may find that the picture and sound are out of sync. With the A/V Sync setting, you can correct this by applying a delay to the audio signal.

To view the TV picture while setting the delay, press **ENTER**.

To return to the previous screen, press **RETURN**.

If HDMI Lip Sync is enabled (→ 54) and your TV or display supports HDMI Lip Sync, the displayed delay time will be the summation of the A/V Sync delay time and the HDMI Lip Sync delay time. The HDMI Lip Sync delay time is displayed underneath in parentheses.

### Note

- A/V Sync is disabled when the Pure Audio listening mode is selected, or when the Direct listening mode is used with an analog input source.
- "A/V Sync" is not operable when the input selector is set to "NET/USB".

## Name Edit

You can enter a custom name for each individual input selector (excluding **TUNER**) and radio preset for easy identification. When entered, the custom name will appear on the display.

The custom name is edited using the character input screen.

### Name

- 1** Use ▲/▼/◀/▶ to select a character, and then press **ENTER**.  
Repeat this step to enter up to 10 characters.
- 2** When you've finished, to store a name, be sure to use ▲/▼/◀/▶ to select "OK", and then press **ENTER**. Otherwise it will not be saved.

Name input area

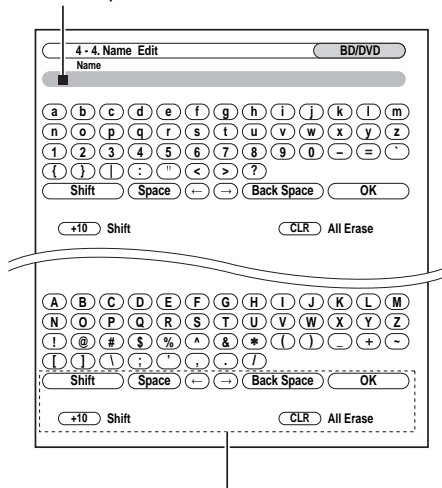

### Shift\*1:

Switches the displayed character.

### Space:

Enters a space character.

### ◀ (Left)/ ▶ (Right):

Selected when the cursor is moved within the Name input area.

### Back Space\*2:

"Back Space" moves the cursor backward one character space. In addition, "Back Space" deletes the character to the left of the cursor.

### OK:

Selects when the entry is complete.

### Tip

- \*1 You can also be performed on the remote controller by using **+10**.
- \*2 Press **CLR** on the remote controller, you can delete all characters in the input.

### To correct a character:

- 1** Use ▲/▼/◀/▶ to select "←"(Left) or "→"(Right), and then press **ENTER**.
- 2** Press **ENTER** several times to select the incorrect character (The cursor moves one letter each time **ENTER** is pressed).
- 3** Use ▲/▼/◀/▶ to select the correct character, and then press **ENTER**.

#### Note

- To name a radio preset, use **TUNER** to select AM or FM, and then select the preset (→ 33).
- “**Name Edit**” is not operable when the input selector is set to “**NET/USB**”.

To restore a custom name to the default, erase the custom name by entering an empty white space for each letter.

## Picture Adjust

Using “**Picture Adjust**”, you can adjust the picture quality and reduce any noise appearing on the screen.

To view the TV picture while setting, press **ENTER**. To return to the previous screen, press **RETURN**.

#### Note

- If you are using the analog RGB input, the following settings have no effect: “**Film Mode**”, “**Edge Enhancement**”, and “**Noise Reduction**”.
- “**Picture Adjust**” is not operable when the input selector is set to “**NET/USB**”.

### ■ Game Mode

#### ▶ Off:

Game Mode off.

#### ▶ On:

Game Mode on.

If video signal delay occurs during playback on a video component (i.e. game console), select the corresponding input source and set the “**Game Mode**” setting to “**On**”. The delay will decrease but in return the picture quality will become poor.

### ■ Wide Mode\*1\*2

This setting determines the aspect ratio.

#### Note

- When the “**Game Mode**” is set to “**On**”, this setting is fixed at “**Full**”.

#### ▶ 4:3:

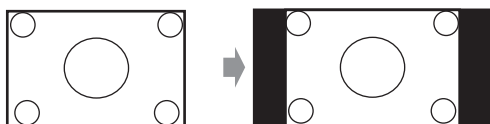

#### ▶ Full:

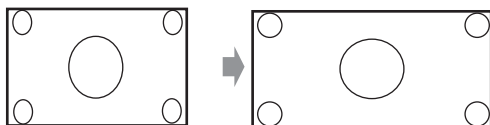

#### ▶ Zoom:

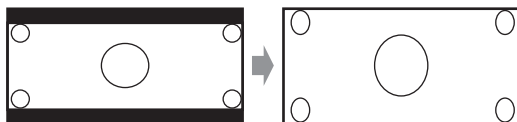

#### ▶ Wide Zoom:

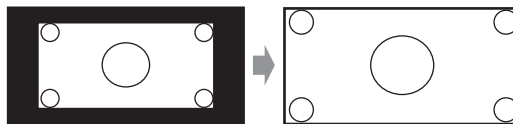

#### ▶ Auto:

According to the input signals and monitor output setting, the AV receiver automatically selects the “**4:3**”, “**Full**”, “**Zoom**” or “**Wide Zoom**” mode. For the monitor output setting (→ 42).

### ■ Picture Mode\*1\*2

#### ▶ Through:

The following settings are set to the default values: “**Film Mode**”, “**Edge Enhancement**”, “**Noise Reduction**”, “**Brightness**”, “**Contrast**”, “**Hue**” and “**Saturation**”

#### ▶ Custom:

You can set the following settings as you like: “**Film Mode**”, “**Edge Enhancement**”, “**Noise Reduction**”, “**Brightness**”, “**Contrast**”, “**Hue**” and “**Saturation**”

#### ▶ Cinema:

Selected when the picture source is movie film, etc.

#### ▶ Game:

Select to use in connecting a game console.

With “**Picture Mode**”, you can change the following settings to be suitable for the movie or game screen by one operation; “**Film Mode**”, “**Edge Enhancement**”, “**Noise Reduction**”, “**Brightness**”, “**Contrast**”, “**Hue**” or “**Saturation**”.

#### Note

- When the “**Picture Mode**” setting is set to other than “**Custom**”, the following settings cannot be selected: “**Film Mode**”, “**Edge Enhancement**”, “**Noise Reduction**”, “**Brightness**”, “**Contrast**”, “**Hue**” and “**Saturation**”.

### ■ Film Mode\*2

#### ▶ Video:

Does not process in either “**3:2**” or “**2:2**”.

#### ▶ Auto:

Adjusts to the picture source, automatically selecting “**Film Mode**”.

#### ▶ 3:2:

Selected when the picture source is movie film, etc.

#### ▶ 2:2:

Selected when the picture source is computer graphics, animation, etc.

The AV receiver will adjust to the picture source, processing in either “**3:2**” or “**2:2**” (**Film Mode**). It automatically converts the source to the appropriate progressive signal and reproduces the natural quality of the original picture. When the “**Film Mode**” setting is set to “**Auto**”, the AV receiver automatically detects the picture source and in either “**3:2**” or “**2:2**”. However, there may be times when you will get a better picture by setting “**Film Mode**” yourself.

#### Note

- If the “**Game Mode**” setting is set to “**On**” (→ 51), this setting is fixed at “**Video**”.

## ■ Edge Enhancement\*2

▶ 0 to +10

With this setting you can adjust the sharpness of edges in the picture. “0” is the softest. “+10” is the sharpest.

## ■ Noise Reduction\*2

▶ **Off:**

Noise reduction off.

▶ **Low:**

Low noise reduction.

▶ **Mid:**

Medium noise reduction.

▶ **High:**

High noise reduction.

With this setting, you can reduce noise appearing on the screen.

### Note

- If the “Game Mode” setting is set to “On” (→ 51), this setting is fixed at “Off”.

## ■ Brightness\*1\*2

▶ -50 to 0 to +50

With this setting you can adjust the picture brightness. “-50” is the darkest. “+50” is the brightest.

## ■ Contrast\*1\*2

▶ -50 to 0 to +50

With this setting you can adjust contrast. “-50” is the least. “+50” is the greatest.

## ■ Hue\*1\*2

▶ -20 to 0 to +20

With this setting you can adjust the red/green balance. “-20” is the strongest green. “+20” is the strongest red.

## ■ Saturation\*1\*2

▶ -50 to 0 to +50

With this setting you can adjust saturation. “-50” is the weakest color. “+50” is the strongest color.

### Tip

\*1 This procedure can also be performed on the remote controller by using the Home menu (→ 26).

\*2 Press **CLR** if you want to reset to the default value.

## Listening Mode Preset

You can assign a default listening mode to each input source that will be selected automatically when you select each input source. For example, you can set the default listening mode to be used with Dolby Digital input signals. You can select other listening modes during playback, but the mode specified here will be resumed once the AV receiver has been set to Standby.

### Main menu

### Listening Mode Preset

**1** Use **▲/▼** to select the input source that you want to set, and then press **ENTER**.

The following menu appears.

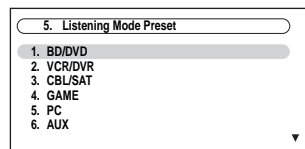

For “TUNER” input selector only “Analog” will be available. For “NET/USB” input source only “Digital” will be available.

### Note

- If you connect an input component (such as UP-A1 series Dock that seated iPod) to the **UNIVERSAL PORT** jack, you can assign only listening modes for the analog sound to “PORT” selector.

**2** Use **▲/▼** to select the signal format that you want to set, and then use **◀/▶** to select a listening mode.

Only listening modes that can be used with each input signal format can be selected (→ 36 to 40).

The “Last Valid” option means that the listening mode selected last will be used.

## ■ Analog/PCM

With this setting, you can specify the listening mode to be used when an analog (CD, TV, LD, VHS, MD, turntable, radio, cassette, cable, satellite, etc.) or PCM digital (CD, DVD, etc.) audio signal is played.

## ■ Mono/Multiplex Source

With this setting, you can specify the listening mode to be used when a mono digital audio signal is played (DVD, etc.).

## ■ 2ch Source

With this setting, the default listening mode for 2-channel (2/0) stereo sources in a digital format, such as Dolby Digital or DTS.

## ■ Dolby D/Dolby D +/TrueHD

With this setting, you can specify the listening mode to be used when a Dolby Digital or Dolby Digital Plus format digital audio signal is played (DVD, etc.). Specifies the default listening mode for Dolby TrueHD sources, such as Blu-ray or HD DVD (input via HDMI).

## ■ DTS/DTS-ES/DTS-HD

With this setting, you can specify the listening mode to be used when a DTS or DTS-HD High Resolution Audio format digital audio signal is played (DVD, LD, CD, etc.). Specifies the default listening mode for DTS-HD Master Audio sources, such as Blu-ray or HD DVD (input via HDMI).

## ■ Other Multich Source

Specifies the default listening mode for multichannel PCM sources from **HDMI IN** such as DVD-Audio, and DSD multichannel sources such as Super Audio CD.

## Miscellaneous

Main menu

Miscellaneous

## Volume Setup

### ■ Volume Display

#### ▶ **Absolute:**

Display range is “Min”, “0.5” through “99.5”, “Max”.

#### ▶ **Relative(THX):**

Display range is “-∞dB”, “-81.5dB” through “+18.0dB”.

With this setting, you can choose how the volume level is displayed.

The absolute value 82 is equivalent to the relative value 0 dB.

### ■ Muting Level

#### ▶ **-∞dB** (fully muted), **-50dB** to **-10dB** in 10 dB steps.

This setting determines how much the output is muted when the muting function is used (→ 26).

### ■ Maximum Volume

#### ▶ **Off**, **50** to **99** (Absolute display)

#### ▶ **Off**, **-32dB** to **+17dB** (Relative display)

With this setting, you can limit the maximum volume. To disable this setting, select “Off”.

### ■ Power On Volume

#### ▶ **Last**, **Min**, **1** to **99** or **Max** (Absolute display)

#### ▶ **Last**, **-∞dB**, **-81dB** to **+18dB** (Relative display)

With this preference, you can specify the volume setting to be used each time the AV receiver is turned on.

To use the same volume level that was used when the AV receiver was turned off, select “Last”.

The “Power On Volume” cannot be set higher than the “Maximum Volume” setting.

### ■ Headphone Level

#### ▶ **-12dB** to **0dB** to **+12dB**

With this preference, you can specify the headphone volume relative to the main volume. This is useful if there's a volume difference between your speakers and your headphones.

## OSD Setup

### ■ On Screen Display

This preference determines whether operation details are displayed onscreen when an AV receiver function is adjusted.

#### ▶ **On:**

Displayed.

#### ▶ **Off:**

Not displayed.

Even when “On” is selected, operation details may not be output if the input source is connected to an **HDMI IN**.

### ■ Language

#### ▶ **English**, **Deutsch**, **Français**, **Español**, **Italiano**, **Nederlands**, **Svenska**, **中文**

This setting determines the language used for the on-screen setup menus.

## Hardware Setup

Main menu

Hardware Setup

## Remote ID

### ■ Remote ID

#### ▶ **1**, **2**, or **3**

When several Onkyo components are used in the same room, their remote ID codes may overlap. To differentiate the AV receiver from the other components, you can change its remote ID from “1”, to “2” or “3”.

#### Note

- If you do change the AV receiver's remote ID, be sure to change the remote controller to the same ID (see below), otherwise, you won't be able to control it with the remote controller.

### Changing the Remote Controller's ID

**1** While holding down **RECEIVER**, press and hold down **SETUP** until **RECEIVER** lights (about 3 seconds).

**2** Use the number buttons to enter ID 1, 2, or 3. **RECEIVER** flashes twice.

## Tuner

For FM/AM tuning to work properly, you must specify the FM/AM frequency step used in your area. Note that when this setting is changed, all radio presets will be deleted.

### ■ FM/AM Frequency Step

#### ▶ **200kHz/10kHz:**

Select if 200 kHz/10 kHz steps are used in your area.

#### ▶ **50kHz/9kHz:**

Select if 50 kHz/9 kHz steps are used in your area.

## HDMI

### ■ Audio TV Out

#### ▶ **Off:**

The audio is not output from the HDMI output.

#### ▶ **On:**

The audio is output from the HDMI output.

This preference determines whether the incoming audio signal is output from the **HDMI OUT**. You may want to turn this preference on if your TV is connected to the **HDMI OUT** and you want to listen to the audio from a connected component through your TV's speakers. Normally, this should be set to "**Off**".

#### Note

- Listening mode cannot be changed when this setting is set to "**On**" and the input source is not HDMI.
- If "**On**" is selected and the audio can be output from the TV, the AV receiver will output no sound through its speakers. In this case, "**TV Sp On**" appears on the display.
- When "**TV Control**" is set to "**On**", this setting is fixed to "**Auto**".
- With some TVs and input signals, no sound may be output even when this setting is set to "**On**" (→ **55**).
- When the "**Audio TV Out**" setting is set to "**On**", or "**TV Control**" is set to "**On**" (→ **55**) and you're listening through your TV's speakers (→ **18**), if you turn up the AV receiver's volume control, the sound will be output by the AV receiver's front left and right speakers. To stop the AV receiver's speakers producing sound, change the settings, change your TV's settings, or turn down the AV receiver's volume.

### ■ Lip Sync

#### ▶ **Disable:**

HDMI lip sync disabled.

#### ▶ **Enable:**

HDMI lip sync enabled.

The AV receiver can be set to automatically correct any delay between the video and the audio, based on the data from the connected monitor.

#### Note

- This function works only if your HDMI-compatible TV supports HDMI Lip Sync.
- You can check the amount of delay being applied by the HDMI Lip Sync function on the A/V Sync screen.

### ■ HDMI Control (RIHD)

#### ▶ **Off:**

**RIHD** disabled.

#### ▶ **On:**

**RIHD** enabled.

This function allows **RIHD**-compatible components connected via HDMI to be controlled with the AV receiver (→ **88** to **89**).

#### Note

- When set to "**On**" and close the menu, the name of connected **RIHD**-compatible components and "**RIHD On**" are displayed on the AV receiver.  
"Search..." → "(name)" → "**RIHD On**"  
When the AV receiver cannot receive the name of the component, it is displayed as "**Player\***" or "**Recorder\***", etc ("\*" means the number of two or more component).  
When set to "**Off**" and close the menu, "**RIHD Off**" are displayed on the AV receiver.  
"Disconnect" → "**RIHD Off**"
- When an **RIHD**-compatible component is connected to the AV receiver via the HDMI cable, the name of the connected component is displayed on the AV receiver display. For example, while you are watching TV broadcasting, if you operate a Blu-ray Disc/DVD player (being powered on) by the remote control of the AV receiver, the name of the Blu-ray Disc/DVD player is displayed on the AV receiver.
- Set to "**Off**" when a connected piece of equipment is not compatible or it is unclear whether the equipment is compatible or not.
- If movement is unnatural when set to "**On**", change the setting to "**Off**".
- Refer to the connected component's instruction manual for details.
- When the source equipment is connected with the **RI** connection, it may malfunction if "**HDMI Control (RIHD)**" is set to "**On**".

### ■ Audio Return Channel

#### ▶ **Off:**

Select "**Off**" if you don't want to use audio return channel (ARC) function.

#### ▶ **Auto:**

The audio signal from your TV tuner can be sent to the **HDMI OUT** of the AV receiver.

Audio return channel (ARC) function enables an HDMI (Audio Return Channel) capable TV to send the audio stream to the **HDMI OUT** of the AV receiver. To use this function, you must select the **TV/CD** input selector and your TV must support ARC function.

#### Note

- The "**Audio Return Channel**" setting can be set only when the "**HDMI Control (RIHD)**" setting is set to "**On**".
- This setting is set to "**Auto**" automatically when the "**HDMI Control (RIHD)**" is set to "**On**" first time.

## ■ Power Control

### ▶ Off:

Power Control disabled.

### ▶ On:

Power Control enabled.

To link the power functions of **RIHD**-compatible components connected via HDMI, select “**On**”.

This setting is set to “**On**” automatically when the “**HDMI Control (RIHD)**” is set to “**On**” first time.

### Note

- The “**Power Control**” setting can be set only when the “**HDMI Control (RIHD)**” setting is set to “**On**”.
- HDMI power control only works with **RIHD**-compatible components that support it and may not work properly with some components due to their settings or compatibility.
- When set to “**On**”, power consumption will increase.
- When set to “**On**”, regardless of whether the AV receiver is On or in Standby, both audio and video stream from an HDMI input will be output to the TV or other components via HDMI connection (HDMI pass through function). When the HDMI pass through function activates in standby mode, **HDMI THRU** indicator will light.
- The power consumption during standby mode will increase during the HDMI pass through function; however if your TV supports CEC (Consumer Electronics Control), the power consumption can be saved in the following cases:
  1. The TV is in standby mode.
  2. You are watching a TV program.
- Refer to the connected component’s instruction manual for details.

## ■ TV Control

### ▶ Off:

TV Control disabled.

### ▶ On:

TV Control enabled.

Set to “**On**” when you want to control the AV receiver from an **RIHD**-compatible TV that is connected to HDMI.

### Note

- Do not assign the component connected with the HDMI input to the **TV/CD** selector when you set “**TV Control**” setting to “**On**”. Otherwise, appropriate CEC (Consumer Electronics Control) operation is not guaranteed.
- Set to “**Off**” when the TV is not compatible or when it is unclear whether the TV is compatible or not.
- The “**TV Control**” setting can be set only when the “**HDMI Control (RIHD)**” (→ 54) and “**Power Control**” (→ 55) settings are both set to “**On**”.
- Refer to the connected component’s instruction manual for details.

After changing the settings of the “**HDMI Control (RIHD)**”, “**Audio Return Channel**”, “**Power Control**”, or “**TV Control**”, turn off the power to all connected pieces of equipment and then turn them on again. Refer to the user’s manuals for all connected pieces of equipment.

## Auto Power Down

### ■ Auto Power Down

#### ▶ Off:

Auto Power Down disabled.

#### ▶ On:

Auto Power Down enabled.

The AV receiver will automatically perform STANDBY operation when “**Auto Power Down**” is set to “**On**”, with no audio or video signal input, and if there is no operation for 30 minutes.

“**Auto Power Down**” will display on the display and OSD from 30 seconds before the Auto Power Down functions.

### Note

- Depending on some sources, the Auto Power Down function may activate during playback.
- The Auto Power Down function does not work when Zone 2 is on.

## Network

See “**Network Settings**” (→ 65).

## Firmware Update

### Note

- Perform the firmware update only when an announcement is posted on the Onkyo web site. See the Onkyo web site for latest information.
- It takes about 30 minutes to complete the firmware update.

### ■ Version

The current version of the firmware is displayed.

### ■ Receiver

#### ▶ via NET:

You can update the firmware via Internet. Check the network connection before update.

#### ▶ via USB:

You can update the firmware from a USB mass storage device.

You can update the AV receiver’s firmware. Do not shut-down the power of the AV receiver while update.

### ■ Universal Port

#### ▶ via NET:

You can update the firmware via Internet. Check the network connection before update.

#### ▶ via USB:

You can update the firmware from a USB mass storage device.

You can update the Onkyo dock’s firmware. Do not shut-down the power of the AV receiver while update.

### Note

- This update shall not be performed when no dock is connected to **UNIVERSAL PORT** jack.

## Lock Setup

With this preference, you can protect your settings by locking the setup menus.

Main menu

Lock Setup

### ■ Setup

#### ▶ **Locked:**

Setup menus locked.

#### ▶ **Unlocked:**

Setup menus not locked.

When the setup menus are locked, you cannot change any setting.

## Using the Audio Settings

You can change various audio settings from the Home menu (→ 26).

**1** Press **RECEIVER** followed by **HOME**.

**2** Use **▲/▼** to select “Audio”, and then use **▲/▼/◀/▶** to make the desired selection.

### Note

- These settings are disabled when:
  - a pair of headphones is connected, or
  - the “**Audio TV Out**” setting is set to “**On**” (→ 54) and an input selector other than **HDMI** is selected.

## Tone Control Settings

You can adjust the bass and treble for the front speakers, except when the Direct, Pure Audio or THX listening mode is selected.

### ■ Bass

▶ **-10dB** to **0dB** to **+10dB** in 2 dB steps.

You can boost or cut low-frequency sounds output by the front speakers.

### ■ Treble

▶ **-10dB** to **0dB** to **+10dB** in 2 dB steps.

You can boost or cut high-frequency sounds output by the front speakers.

### Operating on the AV receiver

**1** Press **TONE** on the AV receiver repeatedly to select either “Bass” or “Treble”.

**2** Use **TONE LEVEL +/-** on the AV receiver to adjust.

### Note

- This setting is not available when the multichannel Analog input is selected.



## Speaker Levels

---

You can adjust the volume of each speaker while listening to an input source.

These temporary adjustments are cancelled when the AV receiver is set to Standby. To save the setting you made here, go to “Level Calibration” (→ 45) before setting the AV receiver to Standby.

### ■ Subwoofer Level

▶ **-15.0dB** to **0.0dB** to **+12.0dB** in 1 dB steps.

### ■ Center Level

▶ **-12.0dB** to **0.0dB** to **+12.0dB** in 1 dB steps.

#### Note

- You cannot use this function while the AV receiver is muted.
- Speakers that are set to “No” or “None” in the “Speaker Configuration” (→ 44) cannot be adjusted.

## Audyssey Settings

---

### ■ Dynamic EQ

See “Dynamic EQ” of “Source Setup” (→ 48).

### ■ Dynamic Volume

See “Dynamic Volume” of “Source Setup” (→ 49).

## Late Night

---

With the Late Night function, you can reduce the dynamic range of Dolby Digital material so that you can still hear quiet parts even when listening at low volume levels—ideal for watching movies late at night when you don’t want to disturb anyone.

### ■ Late Night

For **Dolby Digital** and **Dolby Digital Plus** sources, the options are:

- ▶ **Off:**  
Late Night function off.
- ▶ **Low:**  
Small reduction in dynamic range.
- ▶ **High:**  
Large reduction in dynamic range.

For **Dolby TrueHD** sources, the options are:

- ▶ **Auto:**  
The Late Night function is set to “On” or “Off” automatically.
- ▶ **Off:**  
Late Night function off.
- ▶ **On:**  
Late Night function on.

#### Note

- The effect of the Late Night function depends on the material that you are playing and the intention of the original sound designer, and with some material there will be little or no effect when you select the different options.
- The Late Night function can be used only when the input source is Dolby Digital, Dolby Digital Plus, or Dolby TrueHD.
- The Late Night function is set to “Off” when the AV receiver is set to Standby. For Dolby TrueHD sources, it will be set to “Auto”.

## Music Optimizer

---

The Music Optimizer function enhances the sound quality of compressed music files. Use it with music files that use “lossy” compression, such as MP3.

### ■ Music Optimizer

- ▶ **Off:**  
Music Optimizer off.
- ▶ **On:**  
Music Optimizer on. The **M.Opt** indicator will light (→ 9).

#### Note

- The Music Optimizer function only works with PCM digital audio input signals with a sampling rate below 48 kHz and analog audio input signals. The Music Optimizer is disabled when the Direct or Pure Audio listening mode is selected.
- The setting is stored individually for each input selector.

## Re-EQ

---

With the Re-EQ function, you can compensate a soundtrack whose high-frequency content is too harsh, making it more suitable for home theater viewing.

### ■ Re-EQ

- ▶ **Off:**  
Re-EQ Function off.
- ▶ **On:**  
Re-EQ Function on.

This function can be used with the following listening modes: Dolby Digital, Dolby Digital Plus, Dolby TrueHD, Multichannel, DTS, DTS-HD High Resolution Audio, DTS-HD Master Audio, DTS Express, DSD, Dolby EX, Dolby Pro Logic IIz Height, Dolby PLIIx Movie, Neo:6 Cinema and 5.1-channel source + Neo:6.

### ■ Re-EQ(THX)

- ▶ **Off:**  
Re-EQ (THX) Function off.
- ▶ **On:**  
Re-EQ (THX) Function on.

This function can be used with the following listening modes: THX Cinema, THX Surround EX, and THX Select2 Cinema.

#### Note

- Settings for the Re-EQ function are kept in each listening mode. However, in THX listening mode, when the AV receiver is turned off, it will return to “On”.

## Audio Selector

You can set priorities of audio output when there are both digital and analog inputs.

### ■ Audio Selector

#### ▶ **ARC:**

The audio signal from your TV tuner can be sent to the **HDMI OUT** of the AV receiver.\*1

With this selection the TV's audio can be automatically selected as a priority among other assignments.

#### ▶ **HDMI:**

This can be selected when **HDMI IN** has been assigned as an input source. If both HDMI (**HDMI IN**) and digital audio inputs (**COAXIAL IN** or **OPTICAL IN**) have been assigned, HDMI input is automatically selected as a priority.

#### ▶ **COAX:**

This can be selected when **COAXIAL IN** has been assigned as an input source. If both coaxial and HDMI inputs have been assigned, coaxial input is automatically selected as a priority.

#### ▶ **OPT:**

This can be selected when **OPTICAL IN** has been assigned as an input source. If both optical and HDMI inputs have been assigned, optical input is automatically selected as a priority.

#### ▶ **Multich:**

The AV receiver always outputs analog signals from multichannel analog input.

#### ▶ **Analog:**

The AV receiver always outputs analog signals.

#### Note

- The setting is stored individually for each input selector.
- This setting can be made only for the input source that is assigned as **HDMI IN**, **COAXIAL IN**, or **OPTICAL IN**.
- To select the digital audio input, see "Digital Audio Input" for more detail (→ 43).
- "**Multich**" can be selected only when the selector is set to "**BD/DVD**".

\*1 You can select "**ARC**" if you select the **TV/CD** input selector. But you cannot select it if you've selected "**Off**" in the "**Audio Return Channel**" setting (→ 54).

## Setting the Incoming Digital Signal (Fixed Mode)

By pressing **ENTER** while selecting "**HDMI**", "**COAX**", "**OPT**" in the "**Audio Selector**", you can specify the input signal in the Fixed Mode. Pressing **ENTER** again allows you to return to the "**Audio Selector**" setting.

Normally, the AV receiver detects the signal format automatically. However, if you experience either of the following issues when playing PCM or DTS material, you can manually set the signal format to PCM or DTS.

- If the beginnings of tracks from a PCM source are cut off, try setting the format to PCM.
- If noise is produced when fast forwarding or reversing a DTS CD, try setting the format to DTS.

#### ▶ **Auto:**

The format is detected automatically. If no digital input signal is present, the corresponding analog input is used instead.

#### ▶ **PCM:**

Only 2-channel PCM format input signals will be heard. If the input signal is not PCM, the **PCM** indicator will flash and noise may also be produced.

#### ▶ **DTS:**

Only DTS (but not DTS-HD) format input signals will be heard. If the input signal is not DTS, the **DTS** indicator will flash and there will be no sound.

#### Note

- The setting is stored individually for each input selector.
- The setting will be reset to "**Auto**" when you change the setting in the "**Audio Selector**" (→ 58).

## About NET

The AV receiver is *network-ready*, which means you can hook it up to your home network with a standard Ethernet cable and enjoy the music files stored on your computer or media server. If your network is connected to the Internet, you can also enjoy Internet radio.

## Network Requirements

### ■ Ethernet Network

For best results, a 100Base-TX switched Ethernet network is recommended. Although it's possible to play music on a computer that's connected to the network wirelessly, playback may be unreliable, so wired connections are recommended.

### ■ Ethernet Router

A router manages the network, routing data and supplying IP addresses. Your router must support the following:

- NAT (Network Address Translation). NAT allows several networked computers to access the Internet simultaneously via a single Internet connection. The AV receiver needs Internet access for Internet radio.
- DHCP (Dynamic Host Configuration Protocol). DHCP supplies IP addresses to network devices, allowing them to configure themselves automatically.
- A router with a 100Base-TX switch built-in is recommended.

Some routers have a modem built-in, and some ISPs require you to use specific routers. Please consult your ISP or computer dealer if you're unsure.

### ■ CAT5 Ethernet cable

Use a shielded CAT5 Ethernet cable (straight-type) to connect the AV receiver to your home network.

### ■ Internet Access (for Internet radio)

To receive Internet radio, your Ethernet network must have Internet access. A narrowband Internet connection (e.g., 56K modem, ISDN) will not provide satisfactory results, so a broadband connection is strongly recommended (e.g., cable modem, xDSL modem, etc). Please consult your ISP or computer dealer if you're unsure.

### Note

- To receive Internet radio with the AV receiver, your broadband Internet connection must be working and able to access the Web. Consult your ISP if you have any problems with your Internet connection.
- The AV receiver uses DHCP to configure its network settings automatically. If you want to configure these settings manually, see "Network Settings" (→ 65).
- The AV receiver does not support PPPoE settings, so if you have a PPPoE-type Internet connection, you must use a PPPoE-compatible router.
- Depending on your ISP, you may need to specify a proxy server to use Internet radio. If your computer is configured to use a proxy server, use the same settings for the AV receiver (→ 65).

## Connecting the AV Receiver

To connect the AV receiver to your home network, plug one end of a shielded CAT5 Ethernet cable into the AV receiver's **ETHERNET** port, and plug the other end into a LAN port on your router or switch.

The following diagram shows how you can connect the AV receiver to your home network. In this example, it's connected to a LAN port on a router, which has a 4-port 100Base-TX switch built-in.

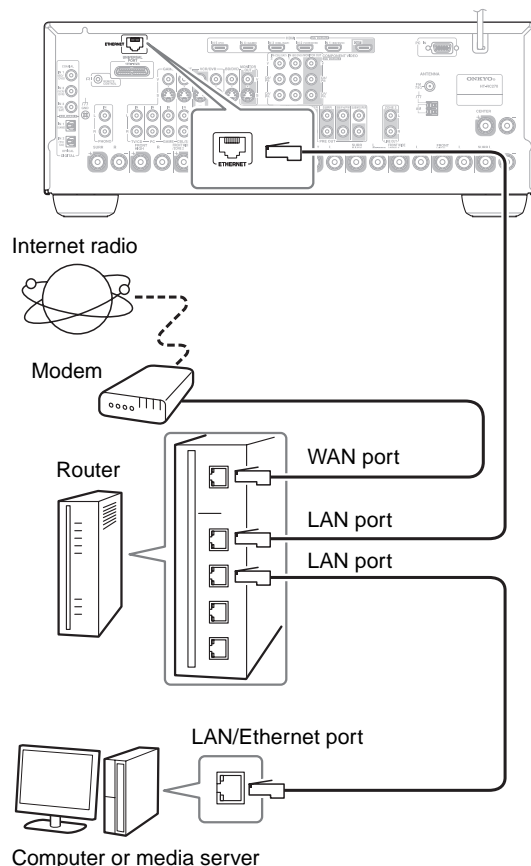

## Listening to Internet Radio

To receive Internet radio, you must connect the AV receiver to a network with Internet access (→ 59). You can select Internet radio stations by connecting to the AV receiver from your computer and selecting stations in your Web browser. Preset up to 40 Internet radio stations. Internet radio URLs in the following formats are supported: PLS, M3U, and podcast (RSS). However, depending on the type of data or audio format used by the Internet radio station, you may not be able to listen to some stations.

### Note

- If you're using a narrowband Internet connection (e.g., 56K modem or ISDN), depending on the station, Internet radio may not work satisfactorily. For best results, use a broadband connection (e.g., cable modem, xDSL modem, etc).

## Listening to vTuner Internet Radio

This unit includes the full vTuner Internet Radio Service at no additional charge. Once you have connected your unit to the Internet you can select vTuner Internet Radio to search for and play Internet radio stations and podcasts at any time. To enhance your Internet radio experience, the <http://onkyo.vtuner.com/> portal is available to you as an easy way to browse to find stations, set up/organize your favorites, add your own stations, get help, etc. After the first time you try Internet radio/vTuner on your unit you can use the MAC Address of your unit to create a member login account (email address and password) on the <http://onkyo.vtuner.com/> portal. To verify your MAC Address, please see "Network Settings" (→ 65).

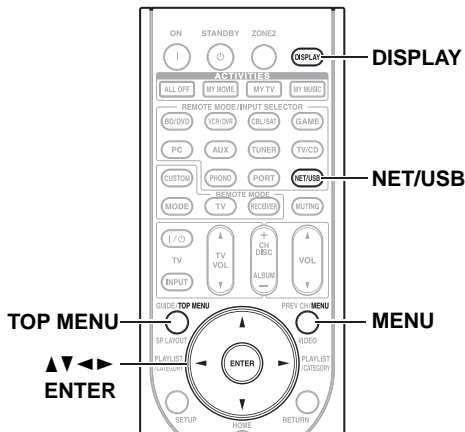

- 1 Press **NET/USB** repeatedly to select the "Internet Radio" screen.

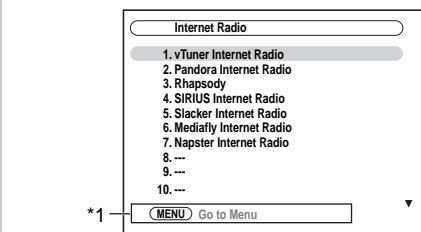

The **NETWORK** indicator lights (→ 9).

### Note

- When the **NETWORK** indicator flashes, confirm that the Ethernet cable is firmly connected to the AV receiver.
- Services available may vary depending on the region. See the separate instructions for more information.

### \*1 MENU:

When menu operations are enabled, "MENU" appears. Press **MENU** to display the menu.

### TOP MENU:

Press **TOP MENU** to go to the top menu of the Internet Radio services.

- 2 Use **▲/▼** to select "1. vTuner Internet Radio", and then press **ENTER**.

- 3 Use **▲/▼** to select a program, and then press **ENTER**.

Playback starts and the following screen appears.

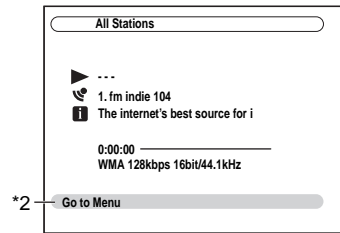

- 2 Press **MENU** to allow selection from the following menu items.

### ▶ Stations like this:

Stations like the one currently being played back are displayed.

### Tip

- If you press **DISPLAY**, you can toggle between the playback screen and the list screen.

## Listening to Other Internet Radio

To listen to other internet radio stations, insert the following step after step 1 in the "Listening to vTuner Internet Radio".

**On your computer, start your Web browser and enter the AV receiver's IP address in the browser's Internet address (URL) field.**

The browser connects to the AV receiver and displays the same screen as the AV receiver.

**Select the Internet radio station with your browser.**

### Note

- The AV receiver's IP address is shown on the "Network" screen (→ 65).
- If you're using DHCP, your router may not always allocate the same IP address to the AV receiver, so if you find that you can't connect to the AV receiver, recheck the AV receiver's IP address on the "Network" screen.

## Registering Presets\*1

Once you've added a station to the list, simply select it on the Internet Radio screen, and then press **ENTER** to start playback.

\*1 From the search results you can preset the stations and songs but cannot listen to them directly.

### ■ Items on the Internet Radio Top Menu

- ▶ Create new preset:  
Add a favorite station or Internet Radio to the presets.
- ▶ Rename this preset:  
You can rename the preset.
- ▶ Delete this preset:  
This will delete the preset.

### ■ Station and Song Presets

You can add the currently playing song or station to the presets.

1. Press **MENU** with the station selected or while a song is playing.
2. Use **▲/▼** to select "Add this station to preset", and press **ENTER**.

## Playing Music Files on a Server

This section explains how to play music files on a computer or media server through the AV receiver. See "Supported Audio File Formats" to "About DLNA" for details on supported music servers and music file formats.

For Windows Media Player 11, see "Windows Media Player 11 Setup" (→ 62).

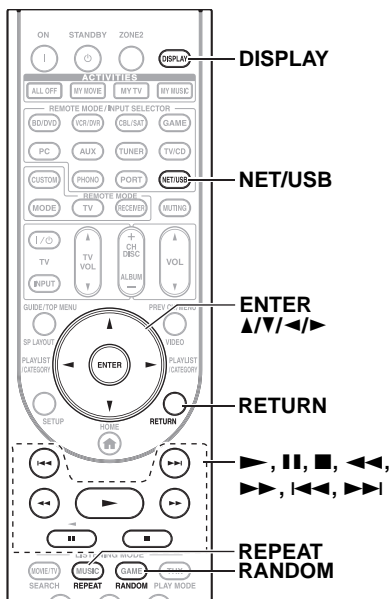

## 1 Start your computer or media server.

## 2 Press **NET/USB** to select the "Server" screen.

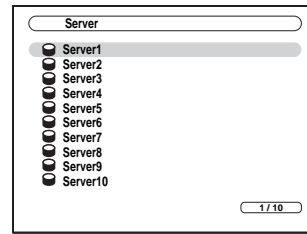

The **NETWORK** indicator lights (→ 9).

### Note

- When the **NETWORK** indicator flashes, confirm the network connection.
- To update the screen, press **RETURN**.

## 3 Use **▲/▼** to select the "Server1", and then press **ENTER**.

A list of items on the server appears.

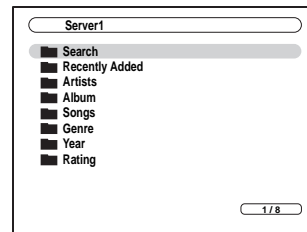

### Search

You can search for music by Artist, Album, or Track.

### Note

- The search function does not work with media servers which do not support this function.
- Depending on the sharing settings in the media server, the AV receiver may not be able to access the content. Refer to the instruction manual of the media server.

## 4 Use **▲/▼** to select an item, and then press **ENTER**.

A list of music files appears.

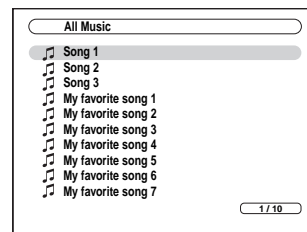

## 5 Use ▲/▼ to select a music file, and press ENTER or ► to start playback.

Playback starts and the following screen appears.

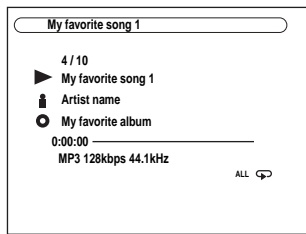

- To return to the previous menu during playback, press **RETURN**.
- To stop playback, press ■.
- To select the next song, press ►►. To select the beginning of the current song, press ◀◀◀. To select the previous song, press ◀◀◀ twice.
- To pause playback, press ■■. To fast forward the current song, press ►►►. To fast reverse the current song, press ◀◀◀.

### Tip

- If you press **DISPLAY**, you can toggle between the playback screen and the list screen.

### Note

- For some sort of media server, Fast Forward/Fast Reverse/Pause operations do not work.

## Random Playback

The Random function can only be set while the **PLAY** screen is displayed.

To play songs in random order, during playback (or while playback is paused or stopped), press **RANDOM**. All of the songs in the current folder will be played in random order. When all of the songs in the folder have been played once, they'll all be played again in a different random order. To cancel random playback, press **RANDOM** again.

Random playback supports up to 20000 songs per folder. If a folder contains more than this, songs over 20000 are not included in random playback.

## Repeat Playback

The Repeat function can only be set while the **PLAY** screen is displayed.

To play songs repeatedly, during playback (or while playback is paused or stopped), press **REPEAT** repeatedly to select: Repeat1, Repeat Folder, Repeat All, or Off.

In Repeat1 mode, the current song is played repeatedly.

In Repeat Folder mode, all of the songs in the current folder are played repeatedly.

In Repeat All mode, all of the songs on the current server are played repeatedly.

To cancel repeat playback, press **REPEAT** repeatedly to select Off.

### Note

- If the message "**No Item.**" appears, this means that no information can be retrieved from the server. In this case, check your server, network, and AV receiver connections.

## Windows Media Player 11 Setup

This section explains how to configure Windows Media Player 11 so that the AV receiver can play the music files stored on your computer.

### 1 Start Windows Media Player 11.

### 2 On the Library menu, select Media Sharing.

The Media Sharing dialog box appears.

### 3 Select the Share my media check box, and then click OK.

### 4 Select the AV receiver in the list, and then click Allow.

### 5 Click OK to close the dialog box.

This completes the Windows Media Player 11 configuration.

You can now play the music files in your Windows Media Player 11 library through the AV receiver (→ 61).

### Note

- Windows Media Player 11 can be downloaded for free from the Microsoft Web site.

## Supported Audio File Formats

For server playback, the AV receiver supports the following music file formats: MP3, WMA, WAV, FLAC, Ogg Vorbis, AAC and LPCM. Not all servers support all formats.

### ■ MP3

- MP3 files must be MPEG-1/MPEG-2 Audio Layer 3 format with a sampling rate of 8 kHz, 11.025 kHz, 12 kHz, 16 kHz, 22.05 kHz, 24 kHz, 32 kHz, 44.1 kHz, 48 kHz and a bit-rate of between 8 kbps and 320 kbps. Incompatible files cannot be played.
- Number of channels: 2
- Variable bit-rate (VBR) MP3 files are supported. (Playing times may not display correctly.)
- MP3 files must have a ".mp3" or ".MP3" filename extension.

### ■ WMA

WMA stands for Windows Media Audio and is an audio compression technology developed by Microsoft Corporation. Audio can be encoded in WMA format by using Windows Media® Player.

- WMA files must have the copyright option turned off.
- Sampling rates of 8 kHz, 11.025 kHz, 12 kHz, 16 kHz, 22.05 kHz, 24 kHz, 32 kHz, 44.1 kHz, 48 kHz and bitrates of between 5 kbps and 320 kbps, and WMA DRM are supported. Incompatible files cannot be played.
- Number of channels: 2
- Variable bit-rates (VBR) are supported. (Playing times may display incorrectly with VBR.)
- WMA Pro/Voice formats are not supported.
- WMA files must have a ".wma" or ".WMA" filename extension.

## ■ WMA Lossless

- Sampling rates of 44.1 kHz, 48 kHz, 88.2 kHz, 96 kHz and bitrates of between 5 kbps and 320 kbps are supported. Incompatible files cannot be played.
- Quantization bit: 16 bit, 24 bit
- Number of channels: 2
- Variable bit-rates (VBR) are supported. (Playing times may display incorrectly with VBR.)
- WMA files must have a “.wma” or “.WMA” filename extension.

## ■ WAV

WAV files contain uncompressed PCM digital audio.

- Sampling rates of 8 kHz, 11.025 kHz, 12 kHz, 16 kHz, 22.05 kHz, 24 kHz, 32 kHz, 44.1 kHz, 48 kHz, 64 kHz, 88.2 kHz, and 96 kHz are supported. Incompatible files cannot be played.
- Quantization bit: 8 bit, 16 bit, 24 bit
- Number of channels: 2
- WAV files must have a “.wav” or “.WAV” filename extension.

## ■ AAC

AAC stands for MPEG-2/MPEG-4 Audio.

- Sampling rates of 8 kHz, 11.025 kHz, 12 kHz, 16 kHz, 22.05 kHz, 24 kHz, 32 kHz, 44.1 kHz, 48 kHz, 64 kHz, 88.2 kHz, 96 kHz and bitrates of between 8 and 320 kbps, are supported. Incompatible files cannot be played.
- Number of channels: 2
- Variable bit-rate (VBR) files are supported. (Playing times may not display correctly.)
- AAC files must have a “.aac”, “.m4a”, “.mp4”, “.3gp”, “.3g2”, “.AAC”, “.M4A”, “.MP4”, “.3GP” or “.3G2” filename extension.

## ■ FLAC

FLAC is a file format for lossless audio data compression.

- Sampling rates of 8 kHz, 11.025 kHz, 12 kHz, 16 kHz, 22.05 kHz, 24 kHz, 32 kHz, 44.1 kHz, 48 kHz, 64 kHz, 88.2 kHz, and 96 kHz are supported. Incompatible files cannot be played.
- Quantization bit: 8 bit, 16 bit, 24 bit
- Number of channels: 2
- Variable bit-rates (VBR) are supported. (Playing times may display incorrectly with VBR.)
- FLAC files must have a “.flac” or “.FLAC” filename extension.

### Note

- Not all servers support all formats.

## ■ Ogg Vorbis

- Sampling rates of 8 kHz, 11.025 kHz, 12 kHz, 16 kHz, 22.05 kHz, 24 kHz, 32 kHz, 44.1 kHz, 48 kHz and bitrates of between 48 kbps and 500 kbps are supported. Incompatible files cannot be played.
- Number of channels: 2
- Variable bit-rates (VBR) are supported. (Playing times may display incorrectly with VBR.)
- Ogg Vorbis files must have a “.ogg” or “.OGG” filename extension.

## ■ LPCM (Linear PCM)

- Sampling rates of 8 kHz, 11.025 kHz, 12 kHz, 16 kHz, 22.05 kHz, 24 kHz, 32 kHz, 44.1 kHz, 48 kHz, 64 kHz, 88.2 kHz, and 96 kHz are supported.
- Quantization bit: 8 bit, 16 bit, 24 bit
- Number of channels: 2

## Server Requirements

The AV receiver can play digital music files stored on a computer or media server and supports the following technologies:

- Windows Media Player 11
- Windows Media Connect 2.0
- DLNA-certified media server

If the operating system of your computer is Windows Vista, Windows Media Player 11 is already installed.

Windows Media Player 11 for Windows XP can be downloaded for free from the Microsoft Web site.

- The computer or media server must be on the same network as the AV receiver.
- Each folder may contain up to 20000 music files, and folders may be nested up to 16 levels deep.

### Note

- For some sort of media server, the AV receiver may not be able to recognize it, or may not be able to play stored music files.

### Minimum system requirements for Windows Media Player 11 for Windows XP

#### Operating system

Windows XP Home Edition (SP2), Windows XP Professional (SP2), Windows XP Tablet PC Edition (SP2), Update Rollup 2 for Windows XP Media Center Edition 2005 (KB900325), October 2006 Update Rollup for Windows XP Media Center Edition (KB925766)

<b>Processor:</b>	233 MHz Intel Pentium II, Advanced Micro Devices (AMD), etc.
<b>Memory:</b>	64 MB
<b>Hard disk:</b>	200 MB of free space
<b>Drive:</b>	CD or DVD drive
<b>Modem:</b>	28.8 kbps
<b>Sound card:</b>	16-bit sound card
<b>Monitor:</b>	Super VGA (800 x 600)
<b>Video card:</b>	64 MB VRAM, DirectX 9.0b
<b>Software:</b>	Microsoft ActiveSync (only when using a Windows Mobile-based Pocket PC or smartphone)
<b>Web browser:</b>	Microsoft Internet Explorer 6 or Netscape 7.1

## About DLNA

The Digital Living Network Alliance is an international, cross-industry collaboration. Members of DLNA develop a concept of wired and wireless interoperable networks where digital content such as photos, music, and videos can be shared through consumer electronics, personal computers, and mobile devices in and beyond the home. The AV receiver certifies the DLNA Interoperability Guidelines version 1.5.

## Remote Playback from Media Server/ Personal Computer

Remote Playback means you can play the music files stored on the DLNA-certified device such as media server with this product by operating the controller device in the home network.

### Server Requirements

- Windows Media Player 12
- DLNA-certified (the DLNA Interoperability Guidelines version 1.5) media server or controller device

Setting varies depending on the device. Refer to your device's instruction manual for details.

If the operating system of your personal computer is Windows 7, Windows Media Player 12 is already installed.

For more information, see the Microsoft Web site.

### Supported Music File Formats

See "Supported Audio File Formats" (→ 62).

#### Note

- For remote playback, this product does not support the following music file formats: FLAC and Ogg Vorbis.

### Windows Media Player 12 Setup

This section explains how to configure Windows Media Player 12 so that the product can play the music files stored on your personal computer.

#### 1 Start Windows Media Player 12.

#### 2 On the "Stream" menu, select "Turn on media streaming".

A dialog box appears.

#### 3 Move your cursor and click on "Turn on media streaming".

A list of media server appears. Wording may vary slightly depending on the network location.

#### 4 Select the product in the list, and then click "Allowed".

#### 5 Click "OK" to close the dialog box.

This completes the Windows Media Player 12 configuration.

You can now play the music files in your Windows Media Player 12 library through the product.

## Using Remote Playback

#### 1 Start Windows Media Player 12.

Before remote playback, setup on Windows Media Player 12 is required.

#### 2 On the product, press **NET/USB** to select the "Server" screen.

A list of media server appears.

#### Tip

- The **NETWORK** indicator on the product's display lights up. When it flashes, confirm the network connection.

#### Note

- While the music files on another media server are being played, remote playback cannot be used. Stop playback on another media server.

#### 3 On Windows Media Player 12, right-click on music file.

Right-click menu appears. For selecting another media server, select media server from "Other Libraries" menu on Windows Media Player 12.

#### 4 Select the product from right-click menu.

"Play to" window appears and playback on the product starts. Operations during remote playback can be made from "Play to" window of Windows 7 on your personal computer. During remote playback, operations (such as Playback, Pause, Fast Forward, Fast Rewind, Previous, Next, Repeat, Random) cannot be made on the product.

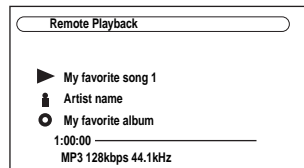

#### Tip

- To stop playback and return to the previous menu during remote playback, press **RETURN** on the product or remote controller. To stop playback during remote playback, press Stop [■] on the remote controller.

#### 5 Adjusting the Volume.

You can adjust the volume of your AV receiver by adjusting the volume bar in the "**Remote playback**" window. The default maximum volume for the AV receiver is 82 (0dB). If you wish to change this, enter the maximum volume value from the Web Setup in your browser.

The volume value of the remote window and the volume value of the AV receiver may not always match. Adjustments you make to the volume in the AV receiver will not be reflected in the "**Remote playback**" window.

Windows and the Windows logo are trademarks of the Microsoft group of companies.



## Network Settings

### Note

- When modifying network settings, after modifying it is necessary to execute “Save”.

This section explains how to configure the AV receiver’s network settings manually.

If your router’s DHCP server is enabled, you don’t need to change any of these settings, as the AV receiver is set use DHCP to configure itself automatically by default (i.e., DHCP is set to Enable). If, however, your router’s DHCP server is disabled, for example, you’re using static IP addresses, you’ll need to configure these settings yourself, in which case, a knowledge of Ethernet networking is essential.

### What’s DHCP?

DHCP (Dynamic Host Configuration Protocol) is used by routers, computers, the AV receiver, and other devices to automatically configure themselves on a network.

### What’s DNS?

The DNS (Domain Name System) translates domain names into IP addresses. For example, when you enter a domain name such as *www.onkyousa.com* in your Web browser, before accessing the site, your browser uses DNS to translate this into an IP address, in this case 63.148.251.142.

## 1 Press RECEIVER followed by SETUP.

The main menu appears onscreen.

### Tip

- If the main menu doesn’t appear, make sure the appropriate external input is selected on your TV.

## 2 Use ▲/▼ to select “Hardware Setup”, and then press ENTER.

The “Hardware Setup” menu appears.

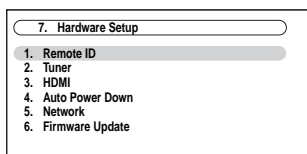

## 3 Use ▲/▼ to select “Network”, and then press ENTER.

The “Network” screen appears.

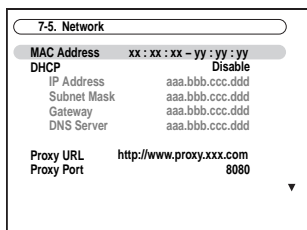

## 4 Use ▲/▼ to select the setting, and use ◀/▶ to set them.

To enter an IP address, select the setting, and then press **ENTER**. The arrow can then be used to enter numbers. Press **ENTER** again to set the number. The settings are explained below.

## 5 When you’ve finished, press RETURN.

The save confirmation screen appears.

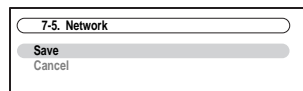

## 6 Use ▲/▼ to select “Save”, and then press ENTER.

When modifying network settings, after modifying it is necessary to execute “Save”.

## 7 Press SETUP.

The setup menu closes.

### Note

- This procedure can also be performed on the AV receiver by using **SETUP**, arrow buttons, and **ENTER**.

### ■ Mac Address

This is the AV receiver’s MAC (Media Access Control) address. This address cannot be changed.

### ■ DHCP

This setting determines whether or not the AV receiver uses DHCP to automatically configure its IP Address, Subnet Mask, Gateway, and DNS Server settings.

#### ▶ Enable:

DHCP enabled.

#### ▶ Disable:

DHCP disabled.

If you select “Disable”, you must configure the “IP Address”, “Subnet Mask”, “Gateway”, and “DNS Server” settings yourself.

### ■ IP Address

If you set the “DHCP” setting to “Disable”, you must specify an IP address. Enter a static IP address provided by your ISP.

The IP address must be within the following ranges.

#### ▶ Class A:

10.0.0.0 to 10.255.255.255

#### ▶ Class B:

172.16.0.0 to 172.31.255.255

#### ▶ Class C:

192.168.0.0 to 192.168.255.255

Most routers use Class C IP addresses.

### ■ Subnet Mask

If you set the “DHCP” setting to “Disable”, you must specify a subnet mask address.

Enter the subnet mask address provided by your ISP (typically: 255.255.255.0).

## ■ Gateway

If you set the “**DHCP**” setting to “**Disable**”, you must specify a gateway address.

Enter the gateway address provided by your ISP.

## ■ DNS Server

If you set the “**DHCP**” setting to “**Disable**”, you must specify a DNS server.

Enter the DNS server addresses provided by your ISP.

## ■ Proxy URL

To use a Web proxy, enter its URL here.

## ■ Proxy Port

If you’re using a Web proxy, enter a proxy port number here.

## ■ Control

This setting enables or disables control over the network.

### ▶ **Enable:**

Control over the network enabled.

### ▶ **Disable:**

Control over the network disabled.

## Note

- When set to “**Enable**”, power consumption on standby mode slightly increases.

## ■ Port Number

This is the network port used for control over the network.

## Note

- Set the port number between from “49152” to “65535”.

## About USB

USB can be used to play music files stored on USB mass storage devices (e.g., USB flash drives and MP3 players), which can be plugged into the AV receiver’s **USB** port.

## Supported Audio File Formats

For USB mass storage device playback, the AV receiver supports music file formats.

See “Supported Audio File Formats” (→ 62).

## USB Mass Storage Device Requirements

- The AV receiver supports USB devices that support the USB mass storage device class.
- Playback may not be possible with some USB devices even if they conform to the USB mass storage device class.
- USB devices formatted with the FAT16 or FAT32 file system are supported.
- If the storage device has been partitioned, each section will be treated as an independent device.
- Each folder may contain up to 20000 music files and folders, and folders may be nested up to 16 levels deep.
- USB hubs and USB devices with hub functions are not supported.

## Playing Music Files on a USB Device

This section explains how to play music files on a USB mass storage device.

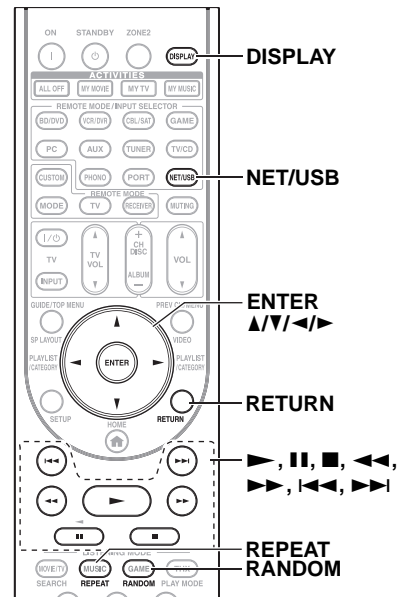

**1** Plug your USB mass storage device into the AV receiver's USB port.

**2** Press **NET/USB** repeatedly to select the "USB" input.

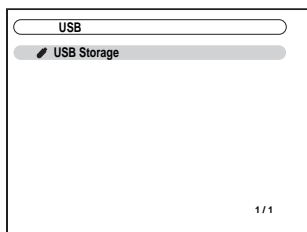

The **USB** indicator lights (→ **9**) if the AV receiver is able to read the USB mass storage device. The **USB** indicator flashes if the AV receiver cannot read the USB mass storage device.

**3** Use **▲/▼** to select a USB mass storage device, and then press **ENTER**.

A list of the device's contents appears.

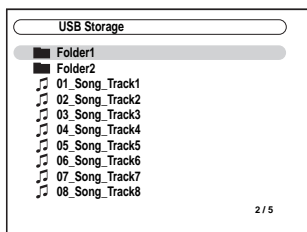

To open a folder, use **▲/▼** to select it, and then press **ENTER**.

**4** Use **▲/▼** to select a music file, and press **ENTER** or **▶** to start playback.

Playback starts and the following screen appears.

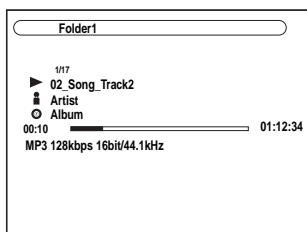

- To return to the previous menu during playback, press **RETURN**.
- To stop or pause playback, press **■** or **||**, respectively.
- To select the next song, press **▶▶**. To select the beginning of the current song, press **◀◀**. To select the previous song, press **◀◀** twice.
- To fast forward the current song, press **▶▶▶**. To fast reverse the current song, press **◀◀◀**.

#### Tip

- If you press **DISPLAY**, you can toggle between the playback screen and the list screen.

## Random Playback

The Random function can only be set while the **PLAY** screen is displayed.

To play songs in random order, while the list of songs is displayed, press **RANDOM**. All of the songs in the current folder will be played in random order. When all of the songs in the folder have been played once, they'll all be played again in a different random order. To cancel random playback, press **RANDOM** again.

Random playback supports up to 20,000 songs per folder. If a folder contains more than this, songs over 20,000 are not included in random playback.

## Repeat Playback

The Repeat function can only be set while the **PLAY** screen is displayed.

To play songs repeatedly, during playback (or while playback is paused or stopped), press **REPEAT** repeatedly to select: Repeat1, Repeat Folder, Repeat All, or Off.

In Repeat1 mode, the current song is played repeatedly.

In Repeat Folder mode, all of the songs in the current folder are played repeatedly.

In Repeat All mode, all of the songs on the USB mass storage device (in the same partition) are played repeatedly.

To cancel repeat playback, press **REPEAT** repeatedly to select Off.

#### Note

- If you connect a USB hard disk drive to the AV receiver's **USB** port, we recommend that you use its **AC** adapter to power it.
- Do not connect the AV receiver's **USB** port to a **USB** port on your computer. Music on your computer cannot be played through the AV receiver in this way.
- The AV receiver supports USB MP3 players that support the USB Mass Storage Class standard, which allows USB storage devices to be connected to computers without the need for special drivers or software. Note that not all USB MP3 players support the USB Mass Storage Class standard. Refer your USB MP3 player's instruction manual for details.
- Protected WMA music files on an MP3 player cannot be played.
- Onkyo accepts no responsibility whatsoever for the loss or damage to data stored on a USB mass storage device when that device is used with the AV receiver. We recommend that you back up your important music files beforehand.
- MP3 players containing music files that are managed with special music software, and the iPod containing music files managed with iTunes are not supported.
- Operation with all USB mass storage devices including the ability to power them is not guaranteed.
- Do not connect your USB mass storage device via a USB hub. The USB mass storage device must be connected directly to the AV receiver's **USB** port.
- If the USB mass storage device contains a lot of data, the AV receiver may take a while to read it.
- USB memory devices with security functions cannot be played.

# Zone 2

In addition to your main listening room, you can also enjoy playback in the other room, or as we call Multi Zone. And, you can select a different source for each room.

## Connecting Zone 2

There are two ways you can connect Zone 2 speakers:

1. Connect them directly to the AV receiver.
2. Connect them to an amp in Zone 2.

### Connecting Your Zone 2 Speakers Directly to the AV receiver

This setup allows 5.1-channel playback in your main room and 2-channel stereo playback in Zone 2, with a different source in each room. This is called Powered Zone 2, as the Zone 2 speakers are powered by the AV receiver. Note that when Powered Zone 2 is turned off, you can enjoy 7.1-channel playback in your main room.

To use this setup, you must set the “Powered Zone2” setting to “Act” (→ 69).

#### Hookup

- Connect your Zone 2 speakers to the AV receiver’s **FRONT WIDE/ZONE 2 L/R** terminals.

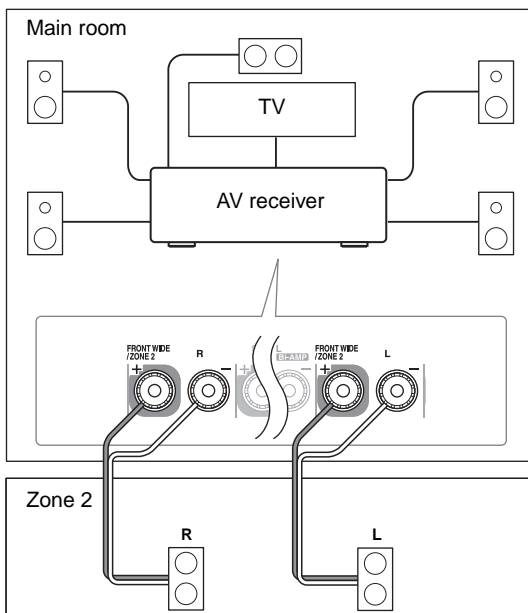

#### Note

- With this setup, the Zone 2 volume is controlled by the AV receiver.
- Powered Zone 2 cannot be used if “Speakers Type(Front)” is set to “Bi-Amp” (→ 44).

### Connecting Your Zone 2 Speakers to an Amp in Zone 2

This setup allows 7.1-channel playback in your main listening room and 2-channel stereo playback in Zone 2, with a different source in each room.

#### Hookup

- Use an RCA audio cable to connect the AV receiver’s **ZONE 2 LINE OUT L/R** jacks to an analog audio input on your Zone 2 amp.
- Connect your Zone 2 speakers to the speaker terminals on your Zone 2 amp.

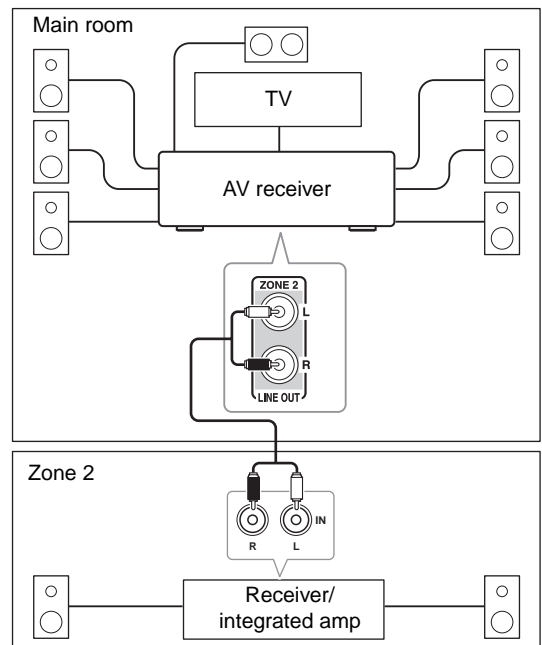

#### Note

- The Zone 2 volume must be set on the Zone 2 amp.

## Setting the Powered Zone 2

If you've connected your Zone 2 speakers to the AV receiver, as explained in "Connecting Your Zone 2 Speakers Directly to the AV receiver" (→ 68), you must set the "Powered Zone2" setting to "Act" (Activated).

### 1 Press RECEIVER followed by SETUP.

The main menu appears onscreen.

#### Tip

- If the main menu doesn't appear, make sure the appropriate external input is selected on your TV.

### 2 Use ▲/▼ to select "Speaker Setup", and then press ENTER.

The "Speaker Setup" menu appears.

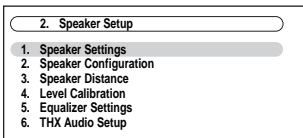

### 3 Use ▲/▼ to select "Speaker Settings", and then press ENTER.

The "Speaker Settings" menu appears.

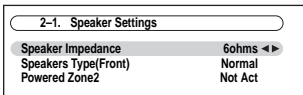

### 4 Use ▲/▼ to select "Powered Zone2", and use ◀/▶ to select:

#### ▶ Not Act:

Use **FRONT WIDE/ZONE 2 L/R** terminals to connect front wide speakers (Powered Zone 2 disabled).

#### ▶ Act:

Use **FRONT WIDE/ZONE 2 L/R** terminals to connect Zone 2 speakers (Powered Zone 2 enabled).

### 5 Press SETUP.

The setup menu closes.

#### Note

- Powered Zone 2 cannot be used if "Speakers Type(Front)" is set to "Bi-Amp" (→ 44).
- This procedure can also be performed on the AV receiver by using **SETUP**, arrow buttons, and **ENTER**.

## Using Zone 2

This section explains how to turn Zone 2 on and off, how to select an input source for Zone 2, and how to adjust the volume for Zone 2.

### Controlling Zone 2 from the AV receiver

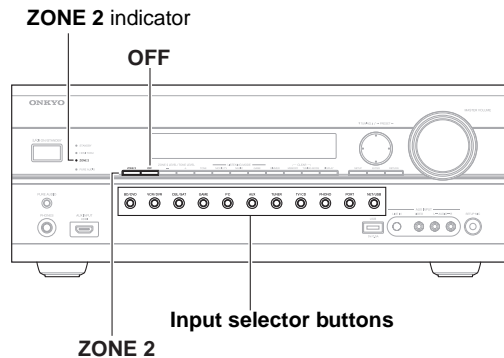

### 1 To turn on Zone 2 and select an input source, press ZONE 2 followed by an input selector button within 8 seconds.

Zone 2 turns on, the **ZONE 2** indicator lights.

To select AM or FM, press **TUNER** input selector and **ZONE 2** repeatedly.

To select the same source as that of the main room, press **ZONE 2** twice. "Zone 2 Selector: Source" appears on the display.

### 2 To turn off Zone 2, press ZONE 2. ZONE 2 indicator flashes.

Press **OFF**.

The zone is turned off, and the **ZONE 2** indicator goes off.

## Controlling Zone 2 with the Remote Controller

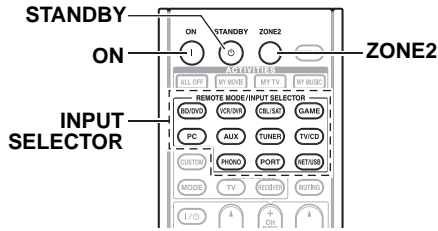

### Note

- To control Zone 2, you must press the remote controller's **ZONE2** first.
- **ZONE2** turns red while Zone 2 is on.

**1** Press **ZONE2**, then point the remote controller at the AV receiver and press **ON**.

**2** To select an input source for Zone 2, press **ZONE2**, followed by **INPUT SELECTOR**.  
To select AM or FM, press **TUNER** input selector and **ZONE2** repeatedly.

**3** To turn off Zone 2, press **ZONE2**, followed by **STANDBY**.

### Note

- Only analog input sources are output by the **ZONE 2 LINE OUT** and **FRONT WIDE/ZONE 2 L/R** terminals. Digital input sources are not output. If no sound is heard when an input source is selected, check if it's connected to an analog input.
- You cannot select different AM or FM radio stations for your main room and Zone 2. The same AM/FM radio station will be heard in each room. For example, if you have an FM station for the main room, that station will also be used in Zone 2.
- When you connect Zone 2 speakers directly to the AV receiver, listening modes that require surround back speakers or front high speakers or front wide speakers (6.1/7.1), such as Dolby Digital EX, DTS-ES, THX Select2 Cinema, Dolby Pro Logic IIz Height, and Audyssey DSX™ are unavailable.
- When the input selector of Zone 2 is selected, power consumption on standby mode slightly increases.
- While Zone 2 is on, **RI** functions will not work.

## Adjusting the Volume for Zone 2

### ■ Operating with the remote controller

**1** Press **ZONE2**.

**2** Use **VOL ▲/▼** to adjust the volume.

### ■ Operating on the AV receiver

**1** Press **ZONE 2** (the **ZONE 2** indicator and **Zone 2** selector on the display flashes).

**2** Use **-/+** within 8 seconds to adjust the volume.

If your Zone 2 speakers are connected to a receiver or integrated amp in Zone 2, use its volume control to adjust the volume.

## Muting Zone 2

### ■ Operating with the remote controller

Press **ZONE2** followed by **MUTING**.

### Tip

- To unmute, press **ZONE2** followed by **MUTING** again.

# Controlling iPod

## Connecting the iPod Directly to the USB Port

USB can be used to play music files stored on iPod/iPhone, which can be plugged into the AV receiver's **USB** port.

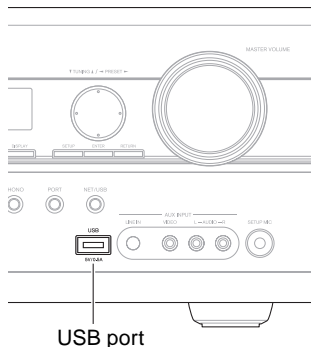

## Playing Music Files on the iPod/iPhone

This section explains how to play music files on the iPod/iPhone.

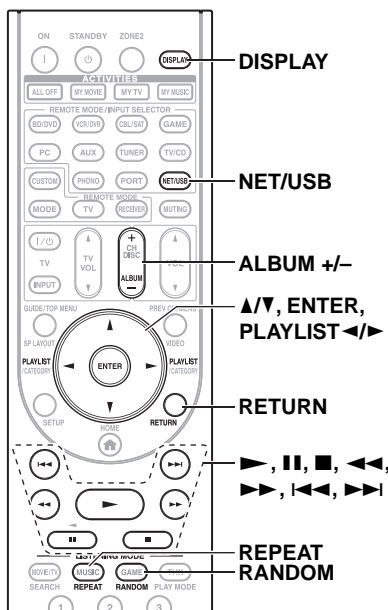

**1** Press **NET/USB** repeatedly to select the **USB** input.

**2** Connect the **USB** cable that comes with the iPod/iPhone\*<sup>1</sup> to the **USB** port at the front of the AV receiver.

- The **USB** indicator lights (→ **9**) if the AV receiver is able to read the iPod/iPhone.
- The **USB** indicator flashes if the AV receiver cannot read the iPod/iPhone.

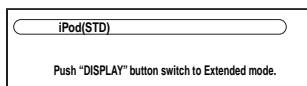

**3** Press **DISPLAY** to switch to **Extended Mode**\*<sup>3</sup>. A list of your iPod model's contents appears. To open a folder, use ▲/▼ to select it, and then press **ENTER**.

### Tip

- With the default settings, the iPod/iPhone can be manipulated as **Standard Mode**\*<sup>2</sup>.
- Pressing **DISPLAY** again switches back to **Standard Mode**.

**4** Use ▲/▼ to select a music file, and press **ENTER** or ► to start playback.

- To return to the previous menu during playback, press **RETURN**.
- To stop or pause playback, press ■ or ■■, respectively.
- To select the next song, press ►►. To select the beginning of the current song, press ◀◀◀. To select the previous song, press ◀◀ twice.
- To fast forward the current song, press ►►. To fast reverse the current song, press ◀◀.
- To switch the repeat mode, press **REPEAT**. To switch the random mode, press **RANDOM**.

## Standard Mode control

The content information is not displayed onscreen, but can be manipulated using the iPod/iPhone or the Remote Control (**NET/USB**).

### Note

- The audio of video content can be played back but no video will be displayed onscreen.

## Extended Mode control

The content information is displayed (lists are displayed) onscreen, and you can select and manipulate the content while looking at the screen.

Top screen list:

- Playlists\*<sup>4</sup>
- Artists\*<sup>4</sup>
- Albums\*<sup>4</sup>
- Genres\*<sup>4</sup>
- Songs\*<sup>4</sup>
- Composers\*<sup>4</sup>
- Shuffle Songs\*<sup>5</sup>
- Now Playing\*<sup>6</sup>

\*<sup>1</sup> Compatible iPod models

Made for:

- iPod touch (1st and 2nd generation)
- iPod classic
- iPod (5th generation)
- iPod nano (1st, 2nd, 3rd, 4th and 5th generation)
- All iPhone models

\*2 The following iPod models are not supported in Standard Mode. These iPod models can only be controlled in Extended Mode.

- iPod (5th generation)
- iPod nano (1st generation)

\*3 When you disconnect the iPod/iPhone, the AV receiver stores the mode. This means that if you disconnect when in Extended Mode, the AV receiver will start in Extended Mode when you next connect the iPod/iPhone.





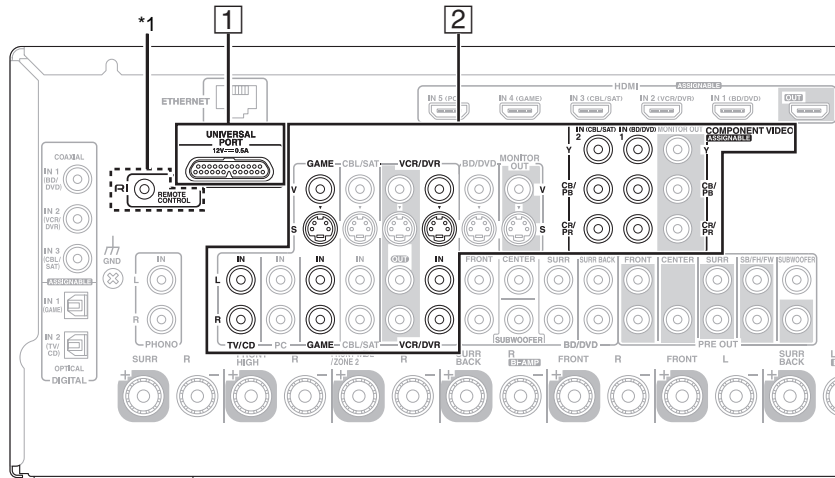

\*4 Displays a list.

\*5 Plays all tracks in random order.

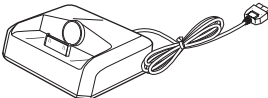
\*6 Displays information about currently playing track.

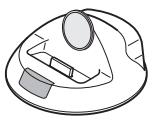
## Connecting an Onkyo Dock

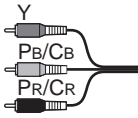
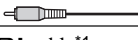

No.	Onkyo Dock	Cable	Note	Page
1	UP-A1 Dock (Universal Port Option Dock) 	—	<ul style="list-style-type: none"> <li>• When UP-A1 Dock that seated iPod is connected, the power consumption on standby mode slightly increases.</li> <li>• You can control your iPod when <b>PORT</b> is selected as the input source.</li> <li>• See the UP-A1 Dock's instruction manual for more information.</li> </ul>	73
2	RI Dock  	Analog audio (RCA)  Component video  Composite video  <b>RI cable</b> *1 	<ul style="list-style-type: none"> <li>• See the RI Dock's instruction manual for more information.</li> <li>*1 To use <b>RI</b> (Remote Interactive), you must make an analog audio connection (RCA) between the AV receiver and the RI Dock.</li> </ul>	74

Models sold are different depending on the region.



## Using the Onkyo Dock

Dock is sold separately.

For the latest information on the Onkyo Dock components, see the Onkyo web site at:

<http://www.onkyo.com>

Before using the Onkyo Dock components, update your iPod with the latest software, available from the Apple web site.

For supported iPod models, see the instruction manual of the Onkyo Dock.

### UP-A1 Dock

With the UP-A1 Dock, you can easily play the music, photo, or movie stored on your Apple iPod through the AV receiver and enjoy great sound.

You can use the AV receiver's remote controller to operate your iPod.

#### ■ Basic Operation

The AV receiver may take several seconds to startup, so you might not hear the first few seconds of the first song.

#### Auto Power On

If you start iPod playback while the AV receiver is on Standby, the AV receiver will automatically turn on and select your iPod as the input source.

#### Direct Change

If you start iPod playback while listening to another input source, the AV receiver will automatically select your iPod as the input source.

#### Using the AV receiver's Remote Controller

You can use the AV receiver's remote controller to control basic iPod functions (→ 74).

#### ■ Operating Notes

- Functionality depends on your iPod model and generation.
- Before selecting a different input source, stop iPod playback to prevent the AV receiver from selecting the iPod input source by mistake.
- If any accessories are connected to your iPod, the AV receiver may not be able to select the input source properly.
- When connecting UP-A1 Dock to the radio tuner UP-HT1 with AUTO selected by the tuner's Mode Selector switch, you can switch the input source between UP-A1 Dock and the tuner, by pressing **PORT** repeatedly on the front panel.
- While your iPod is in the UP-A1 Dock, its volume control has no effect. If you adjust your iPod models volume control while it's in the UP-A1 Dock, make sure it's not set too high before you reconnect your headphones.
- The Auto Power On function will not work if you set your iPod in the UP-A1 Dock while it is playing.
- When Zone 2 is turned on, you can't use Auto Power On and Direct Change functions.
- Do not turn off the power with the iPod still connected to this unit via the UP-A1 Dock.
- Set your iPod in the UP-A1 Dock after the AV receiver turns on.

#### ■ Using Your iPod models Alarm Clock

You can use your iPod models Alarm Clock function to automatically turn on your iPod and the AV receiver at a specified time. The AV receiver's input source will automatically be set to the **PORT** selector.

##### Note

- To use this function, your iPod must be in the UP-A1 Dock, and the UP-A1 Dock must be connected to the AV receiver.
- This function works only in the Standard mode (→ 75).
- When you use this function, be sure to set the AV receiver's volume control to a suitable level.
- When Zone 2 is turned on, you can't use this function.
- You cannot use this function for sound effects on your iPod.

#### ■ Charging Your iPod models Battery

The UP-A1 Dock charges your iPod models battery while your iPod is in the UP-A1 Dock and connected to the **UNIVERSAL PORT** jack on the AV receiver. While your iPod is seated in the UP-A1 Dock, its battery will be charged when the AV receiver is set to "On" or "Standby".

##### Note

- When UP-A1 Dock that seated iPod is connected, the power consumption on standby mode slightly increases.

#### ■ Status Messages

##### • PORT Reading

The AV receiver is checking the connection with the dock.

##### • PORT Not Support

The AV receiver do not support the connected dock.

##### • PORT UP-A1

UP-A1 Dock is connected.

##### Note

- The AV receiver displays the message "UP-A1" for several seconds after recognizing the UP-A1.
- When the status message is not displayed on the AV receiver's display, check the connection to your iPod.

## RI Dock

---

With the RI Dock, you can easily play the music stored on your Apple iPod through the AV receiver and enjoy great sound, and watch iPod slideshows and videos on your TV. In addition, the onscreen display (OSD) allows you to view, navigate, and select your iPod model's contents on your TV, and with the supplied remote controller, you can control your iPod from the comfort of your sofa. You can even use the AV receiver's remote controller to operate your iPod.

### Note

- Enter the appropriate remote control code before using the AV receiver's remote controller for the first time (→ 77).
- Connect the RI Dock to the AV receiver with an **RI** cable (→ 72).
- Set the RI Dock's RI MODE switch to "HDD" or "HDD/DOCK".
- Set the AV receiver's Input Display to "DOCK" (→ 27).

## System Function

### System On

When you turn on the AV receiver, the RI Dock and iPod turn on automatically. In addition, when the RI Dock and iPod are on, the AV receiver can be turned on by pressing **ON/STANDBY**.

### Auto Power On

If you press the remote controller's **▶** while the AV receiver is on Standby, the AV receiver will automatically turn on, select your iPod as the input source, and your iPod will start playback.

### Direct Change

If you start iPod playback while listening to another input source, the AV receiver will automatically switch to the input to which the RI Dock is connected.

### Using the AV receiver's Remote Controller

You can use the AV receiver's remote controller to control basic iPod functions.

### Using Your iPod models Alarm Clock

If you use the Alarm Clock function on your iPod to start playback, the AV receiver will automatically turn on at the specified time and select your iPod as the input source.

### Note

- Linked operations do not work with video playback or when the alarm is set to play a sound.
- If you use your iPod with any other accessories, iPod playback detection may not work.
- This function works only in the Standard mode (→ 75).

## Operating Notes

- Use the AV receiver's volume control to adjust the playback volume.
- While your iPod is inserted in the RI Dock, its volume control has no effect. If you adjust your iPod models volume control while it's in the UP-A1 Dock, make sure it's not set too high before you reconnect your headphones.

### Note

- On the 5th generation iPod and iPod nano, the click wheel is disabled during playback.

## Controlling Your iPod

By pressing **REMOTE MODE** that's been programmed with the remote control code for your Dock, you can control your iPod in the Dock.

See "Entering Remote Control Codes" for details on entering a remote control code (→ 77).

See the Dock's instruction manual for more information.

### UP-A1 Dock

**PORT** is preprogrammed with the remote control code for controlling a Dock with Universal Port connector.

You can control your iPod when "**PORT**" is selected as the input source.

## Without the RI Control

---

You must enter a remote control code **82990** first (→ 77).

### RI Dock

- Set the RI Dock's RI MODE switch to "HDD" or "HDD/DOCK".
- **ON/STANDBY** may not work with a remote control code (without **RI**). In this case, make an **RI** connection and enter a remote control code **81993** (with **RI**).

## With the RI Control

---

In this case, make an **RI** connection and enter a remote control code **81993** (with **RI**).

- Set the AV receiver's Input Display to "**DOCK**" (→ 27).

Press the appropriate **REMOTE MODE** first.

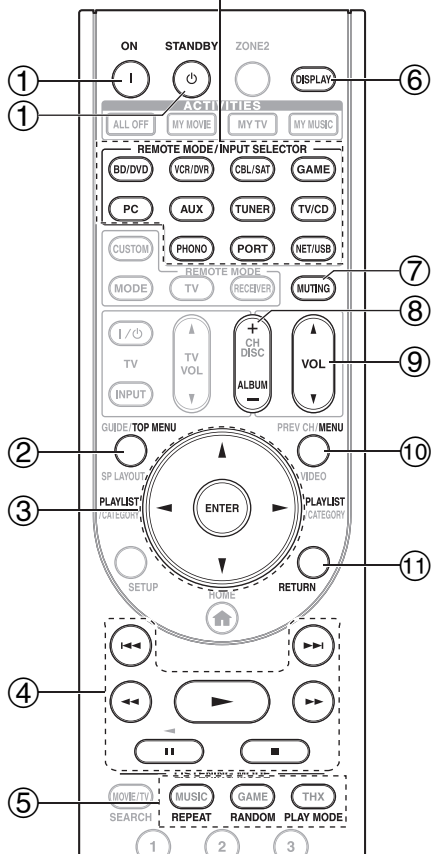

✓: Available buttons

Buttons	Onkyo Dock	
	UP-A1 Dock	RI Dock
① <b>ON, STANDBY</b>		✓*1
② <b>TOP MENU</b>		✓*5
③ <b>▲/▼/◀/▶ ENTER</b> <b>PLAYLIST ◀/▶</b>	✓	✓
④ <b>▶,   , ■, ◀▶, ▶▶, ◀◀, ▶▶▶</b>	✓	✓
⑤ <b>REPEAT</b> <b>RANDOM</b> <b>PLAY MODE</b>	✓	✓
⑥ <b>DISPLAY*6</b>	✓*2	✓
⑦ <b>MUTING</b>	✓	✓
⑧ <b>ALBUM +/-</b>	✓	✓
⑨ <b>VOL ▲/▼</b>	✓	✓
⑩ <b>MENU</b>		✓
⑪ <b>RETURN</b>	✓	

- With some iPod models, generations and RI Docks, certain buttons may not work as expected.
- For detailed operation of the iPod, please refer to the instruction manual of RI Dock.

\*1 This button does not turn the Onkyo DS-A2 or DS-A2X RI Dock on or off. Your iPod may not respond the first time you press this button, in which case you should press it again.

This is because the remote controller transmits the On and Standby commands alternately, so if your iPod is already on, it will remain on when the remote controller transmits an On command.

Similarly, if your iPod is already off, it will remain off when the remote controller transmits an Off command.

\*2 Press **DISPLAY** to change the following modes:

#### Standard mode

Nothing is displayed on your TV and you navigate and select your contents by using your iPod models display.

Only this mode can playback the video.

#### Extended mode (Music)

Playlists (artists, albums, songs, and so on) are displayed on your TV, and you can navigate and select your music while looking at your TV.

#### Extended mode (Video)

Playlists (Movies, Music Videos, TV Shows, Video Podcasts, or Rentals) are displayed on your TV, and you can navigate and select your video while looking at your TV.

\*3 In Extended mode (see \*2), **PLAYLIST** is used as the page jump button.

With the page modes, you can quickly locate your favorite songs even when your song lists, artist lists, and so on are very long.

\*4 **Resume mode**

With the Resume function, you can resume playback of the song that was playing when you removed your iPod from the RI Dock or Standard mode is selected.

\*5 **TOP MENU** works as a Mode button when used with a DS-A2 RI Dock.

\*6 **DISPLAY** turns on backlight for 30 seconds.

#### Note

- In Extended mode (see \*2), the playback will be continued even if the AV receiver is turned off.
- In Extended mode (see \*2), you cannot operate your iPod directly.
- In Extended mode (see \*2), it may take some time to acquire the contents.

# Controlling Other Components

You can use the AV receiver's remote controller (RC-768M) to control your other AV components, including those made by other manufacturers. This section explains how to enter the remote control code (with the default underlined) for a component that you want to control: DVD, TV, CD, etc.

- Learn commands directly from another component's remote controller (→ 80).
- Program **ACTIVITIES** to perform a sequence of up to 32 remote control actions (→ 80).

## Preprogrammed Remote Control Codes

The following **REMOTE MODE** are preprogrammed with remote control codes for controlling the components listed. You do not need to enter a remote control code to control these components.

For details on controlling these components, see the pages indicated.

- BD/DVD** Onkyo Blu-ray Disc player (→ 78)  
**TV/CD** Onkyo CD player (→ 78)  
**PORT** Onkyo Universal Port Option (→ 74)

## Looking up for Remote Control Code

You can look up for appropriate remote control code from on-screen setup menu.

This setting can not be carried out by using the AV receiver's display.

- 1 Press **RECEIVER** followed by **SETUP**.  
The main menu appears onscreen.

### Tip

- If the main menu doesn't appear, make sure the appropriate external input is selected on your TV.

- 2 Use **▲/▼** to select "Remote Controller Setup", and then press **ENTER**.  
The "Remote Controller Setup" menu appears.

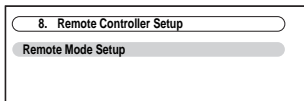

- 3 Press **ENTER**.  
The "Remote Mode Setup" menu appears.

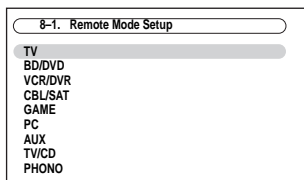

- 4 Use **▲/▼** to select remote mode, and then press **ENTER**.

The category selection menu appears.

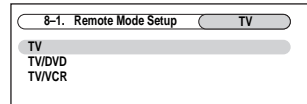

- 5 Use **▲/▼** to select category, and then press **ENTER**.

The brand name input panel appears.

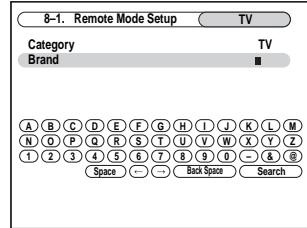

- 6 Use **▲/▼/◀/▶** to select a character, and then press **ENTER**.

Repeat this step from the 1st character to the 3rd character of the brand name.

When you have entered the 3rd character, press **ENTER**.

After searching, a list of the brand name appears.

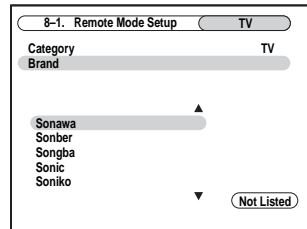

### Tip

- If the brand name is not found, use **▶** to select "Not Listed", and then press **ENTER**.

The brand name input panel appears.

- 7 Use **▲/▼** to select brand, and then press **ENTER**.

After searching, a remote control code and the input procedure appear. Try it.

Remote control code  
(Number of search results)

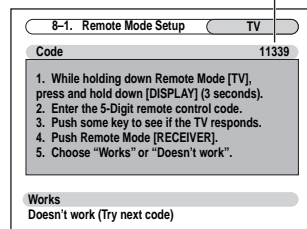

**8** If you can control component, press **RECEIVER**, use **▲/▼** to select “Works”, and then press **ENTER**.

The “Remote Mode Setup” menu appears.

If you cannot control component, use **▲/▼** to select “Doesn’t work (Try next code)” and press **ENTER**.

The next code is appear.

**9** Press **SETUP**.

The setup menu closes.

## Entering Remote Control Codes

You’ll need to enter a code for each component that you want to control.

**1** Look up the appropriate remote control code in the separate Remote Control Codes list.

The codes are organized by category (e.g., DVD player, TV, etc.).

**2** While holding down **REMOTE MODE** to which you want to enter a code, press and hold down **DISPLAY** (about 3 seconds).

The **REMOTE MODE** button lights.

### Note

- Remote control codes cannot be entered for **RECEIVER** and **ZONE2**.
- Only TV remote control codes can be entered for **TV**.
- Except for **RECEIVER**, **TV** and **ZONE2**, remote control codes from any category can be entered as **REMOTE MODE**. However, these buttons also work as input selector buttons (→ 25), so choose a **REMOTE MODE** that corresponds with the input to which you connect your component. For example, if you connect your CD player to the CD input, choose **TV/CD** when entering its remote control code.

**3** Within 30 seconds, use the number buttons to enter the 5-digit remote control code.

The **REMOTE MODE** button flashes twice.

If the remote control code is not entered successfully, **REMOTE MODE** button will flash once slowly.

### Note

- The remote control codes provided are correct at the time of printing, but are subject to change.

## Remote Control Codes for Onkyo Components Connected via RI

Onkyo components that are connected via **RI** are controlled by pointing the remote controller at the AV receiver, not the component. This allows you to control components that are out of view, in a rack, for example.

**1** Make sure the Onkyo component is connected with an **RI** cable and an analog audio cable (**RCA**).

See “Connecting Onkyo **RI** Components” for details (→ 20).

**2** Enter the appropriate remote control code for **REMOTE MODE**.

• **BD/DVD**

▶ **31612**:

Onkyo DVD player with **RI**

• **TV/CD**

▶ **71327**:

Onkyo CD player with **RI**

▶ **42157**:

Onkyo cassette tape deck with **RI**

• **PORT**

▶ **81993**:

Onkyo Dock with **RI**

See the previous section for how to enter remote control codes.

### Note

- When using a cassette tape deck connected via **RI**, press and hold **TV/CD** to switch to **TAPE**.

**3** Press **REMOTE MODE**, point the remote controller at the AV receiver, and operate the component.

If you want to control an Onkyo component by pointing the remote controller directly at it, or you want to control an Onkyo component that’s not connected via **RI**, use the following remote control codes:

• **BD/DVD**

▶ **30627**:

Onkyo DVD player without **RI**

• **TV/CD**

▶ **71817**:

Onkyo CD player without **RI**

▶ **11807**:

TV with **RIHD**

If you want to control an Onkyo component by pointing the remote controller directly at it, use the following remote control codes:

- ▶ **32900:**  
Onkyo Blu-ray Disc player
- ▶ **32901:**  
Onkyo HD-DVD player
- ▶ **70868:**  
Onkyo MD recorder without **RI**
- ▶ **71323:**  
Onkyo CD recorder without **RI**
- ▶ **82990:**  
Onkyo Dock without **RI**

#### Note

- If you connect a cassette tape deck to the **TV/CD IN** jack, or connect an **RI Dock** to the to the **TV/CD IN** or **VCR/DVR IN** or **GAME IN** jacks, for **RI** to work properly, you must set the Input Display accordingly (→ 27).

## Resetting REMOTE MODE Buttons

You can reset a **REMOTE MODE** to its default remote control code.

- 1** While holding down **REMOTE MODE** that you want to reset, press and hold down **HOME** until **REMOTE MODE** lights (about 3 seconds).
- 2** Within 30 seconds, press **REMOTE MODE** again. **REMOTE MODE** flashes twice, indicating that the button has been reset.  
Each of **REMOTE MODE** is preprogrammed with a remote control code. When a button is reset, its pre-programmed code is restored.

#### Note

- The learning command is also reset.

## Resetting the Remote Controller

You can reset the remote controller to its default settings.

- 1** While holding down **RECEIVER**, press and hold down **HOME** until **RECEIVER** lights (about 3 seconds).
- 2** Within 30 seconds, press **RECEIVER** again. **RECEIVER** flashes twice, indicating that the remote controller has been reset.

## Controlling Other Components

By pressing **REMOTE MODE** that's been programmed with the remote control code for your component, you can control your component as below.

For details on entering a remote control code for other components, see "Entering Remote Control Codes" (→ 77).

### Controlling a TV

**TV** is preprogrammed with the remote control code for controlling a TV that supports the **RIHD**\*1 (limited to some models). The TV must be able to receive remote control commands via **RIHD** and be connected to the AV receiver via HDMI. If controlling your TV via **RIHD** doesn't work very well, program your TV's remote control code into **TV** and use the TV remote mode to control your TV.

### Controlling a Blu-ray Disc/DVD Player, HD DVD Player or DVD Recorder

**BD/DVD** is preprogrammed with the remote control code for controlling a component that supports the **RIHD**\*1 (limited to some models). The component must be able to receive remote control commands via **RIHD** and be connected to the AV receiver via HDMI.

\*1 The **RIHD** supported by the AV receiver is the CEC system control function of the HDMI standard.

Press the appropriate **REMOTE MODE** first.

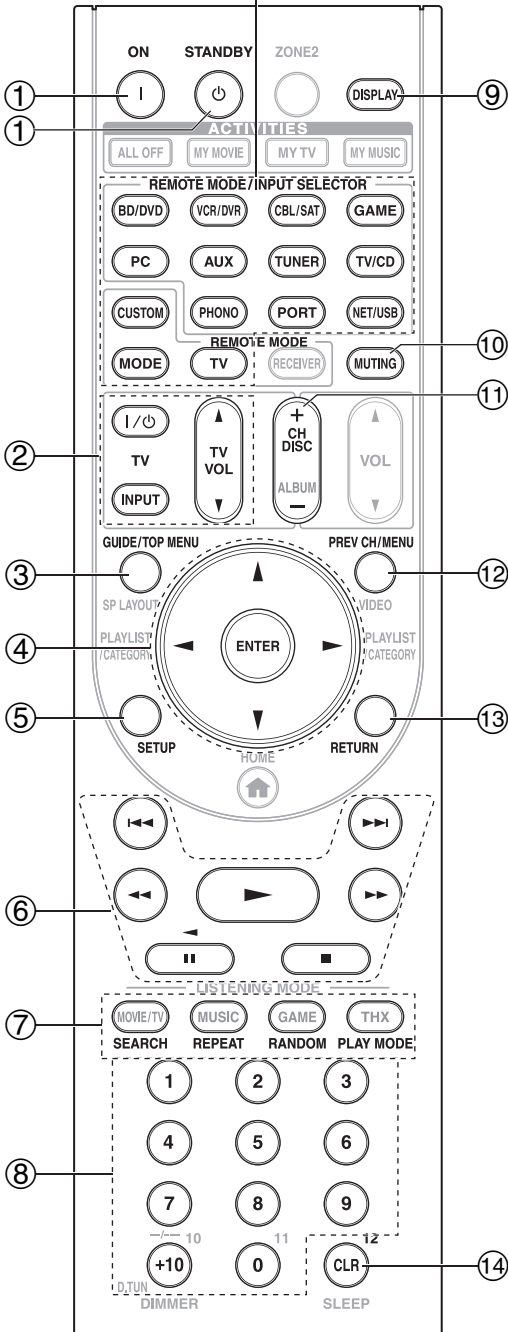

**Note**

- With some components, certain buttons may not work as expected, and some may not work at all.

✓: Available buttons

Buttons	TV	DVD player/DVD recorder	Blu-ray Disc player HD DVD player	VCR/PVR	Satellite receiver Cable receiver	CD player/CD recorder MD recorder	Cassette tape deck
① ON, STANDBY	✓	✓		✓	✓	✓	✓
② I/O, INPUT, TV VOL ▲/▼	✓						
③ GUIDE TOP MENU	✓			✓	✓		
④ ▲/▼/◀/▶ ENTER	✓	✓		✓	✓	✓	
⑤ SETUP	✓	✓			✓	✓	
⑥ ▶,   , ■, ◀, ▶, I, ◀, ▶, I	✓*1	✓		✓	✓	✓	✓*3
⑦ SEARCH	✓*1*2	✓*1	✓*2		✓*2	✓	
REPEAT	✓*1*2		✓*2		✓*2	✓	
RANDOM	✓*1*2	✓*1	✓*2		✓*2	✓	
PLAY MODE	✓*1*2	✓*1	✓*2		✓*2	✓	
⑧ Number: 1 to 9, 0	✓	✓		✓	✓	✓	
Number: +10	✓*1	✓*1		✓	✓	✓	
⑨ DISPLAY	✓	✓		✓	✓	✓	
⑩ MUTING	✓	✓		✓	✓	✓	✓
⑪ CH +/- DISC +/-	✓	✓		✓	✓	✓	
⑫ PREV CH MENU	✓			✓	✓		
⑬ RETURN	✓	✓		✓	✓		
⑭ CLR	✓	✓		✓	✓	✓	

\*1 The **RJHD** function is not supported. The **RJHD** supported by the AV receiver is the CEC system control function of the HDMI standard.

\*2 These buttons function as colored buttons or A, B, C, D buttons.

\*3 **||** (Pause) functions as reverse playback.

**Note**

- See the “Controlling Your iPod” about the operation of iPod (→ 74).

## Learning Commands

The AV receiver's remote controller can learn the commands of other remote controllers. By transmitting, for example, the Play command from your CD player's remote controller, the remote controller can learn it, and then transmit the exact same command when its ► is pressed in the CD remote mode.

This is useful when you've entered the appropriate remote control code (→ 77) but some buttons don't work as expected.

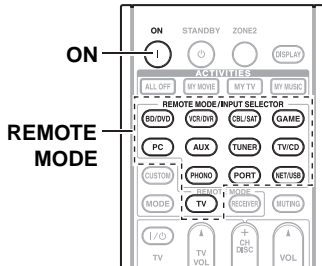

**1** While holding down **REMOTE MODE** for the mode in which you want to use the command, press and hold down **ON** until **REMOTE MODE** button lights (about 3 seconds).

**2** On the supplied remote controller, press the button you want to learn the new command.

**3** Point the remote controllers at each other, about 2 to 6 inches (5 to 15 cm) apart, and then press and hold the button whose command you want to learn until **REMOTE MODE** button flashes.

If the command is learned successfully, **REMOTE MODE** button flashes twice.

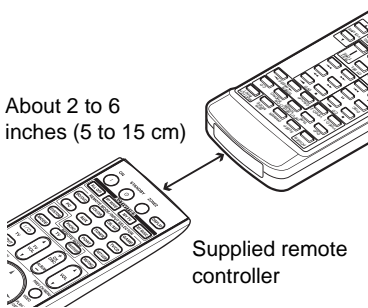

**4** To learn more commands, repeat steps 2 and 3. Press any **REMOTE MODE** when you've finished. **REMOTE MODE** button flashes twice.

## Note

- The following buttons cannot learn new commands: **REMOTE MODE, ALL OFF, MY MOVIE, MY TV, MY MUSIC**.
- The remote controller can learn approximately 70 to 90 commands, although this will be less if commands that use a lot of memory are learned.
- Remote controller buttons such as Play, Stop, Pause, and so on are preprogrammed with commands for controlling Onkyo CD players, cassette decks, and DVD players. However, they can learn new commands, and you can restore the preprogrammed commands at any time by resetting the remote controller (→ 78).
- To overwrite a previously learned command, repeat this procedure.
- Depending on the remote controller that you are using, there may be some buttons that won't work as expected, or even some remotes that cannot be learned at all.
- Only commands from infrared remote controllers can be learned.
- When the remote controller's batteries expire, all learned commands will be lost and will have to be learned all over again, so don't discard your other remote controllers.

## Deleting Learning Commands

1. While holding down **REMOTE MODE** for the mode in which you want to delete the command, press and hold down **TV I/O** until **REMOTE MODE** button lights (about 3 seconds).
2. Press **REMOTE MODE** or the button from which you want to delete the commands. **REMOTE MODE** button flashes twice. When you press **REMOTE MODE**, all commands learned in that remote mode will be deleted.

## Using Normal Macros

You can program the remote controller's **ACTIVITIES** to perform a sequence of remote control actions.

### Example:

To play a CD you typically need to perform the following actions:

1. Press **RECEIVER** to select the Receiver remote controller mode.
2. Press **ON** to turn on the AV receiver.
3. Press **TV/CD** to select the TV/CD input source.
4. Press ► to start playback on the CD player.

You can program **ACTIVITIES** so that all four actions are performed with just one button press.



## Making Macros

Each **ACTIVITIES** can store one macro, and each macro can contain up to 32 commands.

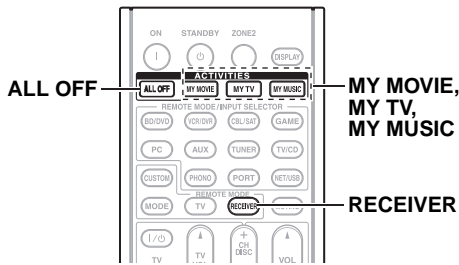

## Deleting Macros

- 1 While holding down **HOME**, press and hold down **ALL OFF** until **ALL OFF** lights (about 3 seconds).
- 2 Press **ALL OFF** again. **ALL OFF** flashes twice.

### Note

- It changes into Easy macro mode when the macro is deleted (→ 28).
- When you using Normal macro mode, you cannot use the easy macro command including the change of the source component.

- 1 While holding down **RECEIVER**, press and hold down **MY MOVIE**, **MY TV**, or **MY MUSIC** until **MY MOVIE**, **MY TV**, or **MY MUSIC** lights (about 3 seconds).

- 2 Press the buttons whose actions you want to program into the macro in the order you want them performed.

For the CD example above, you'd press the following buttons: **ON**, **TV/CD**, **▶**.

### Note

- **MODE** is invalid at macro making operation.

- 3 When you've finished, press **ACTIVITIES** again. **ACTIVITIES** button flashes twice.

If you enter 32 commands, the process will finish automatically.

### Note

- Once you have taught a new macro commands, the original macro will no longer work. If you retrieve it, you will have to taught again.

## Running Macros

### Press **MY MOVIE**, **MY TV**, or **MY MUSIC**.

The commands in the macro are transmitted in the order in which they were programmed. Keep the remote controller pointed at the AV receiver until all of the commands have been transmitted.

Macros can be run at any time, regardless of the current remote controller mode.

# Troubleshooting

If you have any trouble using the AV receiver, look for a solution in this section. If you can't resolve the issue yourself, contact your Onkyo dealer.

If you can't resolve the issue yourself, try resetting the AV receiver before contacting your Onkyo dealer.

**To reset the AV receiver to its factory defaults, turn it on and, while holding down VCR/DVR, press ON/STANDBY. "Clear" will appear on the display and the AV receiver will enter Standby mode.**



Note that resetting the AV receiver will delete your radio presets and custom settings.

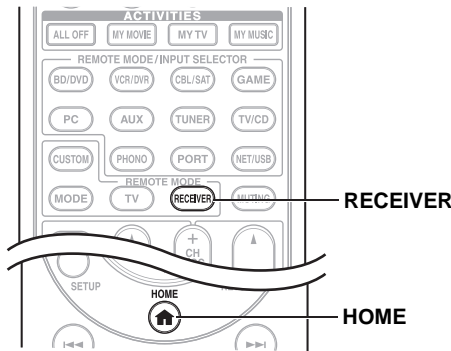

To reset the remote controller to its factory defaults, while holding down **RECEIVER**, press and hold down **HOME** until **RECEIVER** button lights (about 3 seconds). Within 30 seconds, press **RECEIVER** again.

**The on-screen setup menus appear only on a TV that is connected to the HDMI OUT. If your TV is connected to the MONITOR OUT V, MONITOR OUT S or the COMPONENT VIDEO MONITOR OUT, use the AV receiver's display when changing settings.**

## Power

### Can't turn on the AV receiver

Make sure that the power cord is properly plugged into the wall outlet.

Unplug the power cord from the wall outlet, wait five seconds or more, then plug it in again.

### The STANDBY indicator flashes red

The protection circuit has been activated. Remove the power cord from the wall outlet immediately. Disconnect all speaker cables and input sources, and leave the AV receiver with its power cord disconnected for 1 hour. After that, reconnect the power cord and set the volume to maximum. If the AV receiver stays on, set the volume to minimum, disconnect the power cord, and reconnect your speakers and input sources. If the AV receiver turns off when you set the volume to maximum, disconnect the power cord, and contact your Onkyo dealer.

## Audio

### There's no sound, or it's very quiet

Make sure that the digital input source is selected properly. **43**

Make sure that all audio connecting plugs are pushed in all the way. **17**

Make sure that the inputs and outputs of all components are connected properly. **18-20**

Make sure that the polarity of the speaker cables is correct, and that the bare wires are in contact with the metal part of each speaker terminal. **13**

Make sure that the input source is properly selected. **25**

Make sure that the speaker cables are not shorting. **13**

Check the volume. The AV receiver is designed for home theater enjoyment. It has a wide volume range, allowing precise adjustment.

If the **MUTING** indicator is flashing on the display, press the remote controller's **MUTING** to unmute the AV receiver. **26**

While a pair of headphones is connected to the **PHONES** jack, no sound is output by the speakers. **27**

If there's no sound from a DVD player connected to an HDMI IN, check the DVD player's output settings, and be sure to select a supported audio format.

Check the digital audio output setting on the connected device. On some game consoles, such as those that support DVD, the default setting is off.

With some DVD-Video discs, you need to select an audio output format from a menu.

If your turntable uses an MC cartridge, you must connect an MC head amp, or an MC transformer.

Make sure that none of the connecting cables are bent, twisted, or damaged.

Not all listening modes use all speakers. **36**

Specify the speaker distances and adjust the individual speaker levels. **45**

Make sure that the speaker setup microphone is not still connected.

The input signal format is set to "PCM" or "DTS". Set it to "Auto". **58**

## ■ Only the front speakers produce sound

When the Stereo or Mono listening mode is selected, only the front speakers and subwoofer produce sound. —

In the Mono listening mode, only the front speakers output sound if the “**Output Speaker**” setting is set to “**Left / Right**”. **47**

Check the Speaker Configuration. **44**

## ■ Only the center speaker produces sound

If you use the Dolby Pro Logic IIx Movie, Dolby Pro Logic IIx Music, or Dolby Pro Logic IIx Game listening mode with a mono source, such as an AM radio station or mono TV program, the sound is concentrated in the center speaker. —

In the Mono listening mode, only the front speakers output sound if the “**Output Speaker**” setting is set to “**Center**”. **47**

Make sure the speakers are configured correctly. **44**

## ■ The surround speakers produce no sound

When the T-D (Theater-Dimensional), Stereo or Mono listening mode is selected, the surround speakers produce no sound. —

Depending on the source and current listening mode, not much sound may be produced by the surround speakers. Try selecting another listening mode. —

Make sure the speakers are configured correctly. **44**

## ■ The center speaker produces no sound

When the Stereo or Mono listening mode is selected, the center speaker produces no sound. —

In the Mono listening mode, only the front speakers output sound if the “**Output Speaker**” setting is set to “**Left / Right**”. **47**

Make sure the speakers are configured correctly. **44**

## ■ The front high, front wide and surround back speakers produce no sound

Depending on the current listening mode, no sound may be produced by the front high, front wide and surround back speakers. Select another listening mode. **36**

Not much sound may be produced by the front high, front wide and surround back speakers with some sources. —

Make sure the speakers are configured correctly. **44**

While Powered Zone 2 is being used, playback in the main room is reduced to 5.1-channels and the front high, front wide and surround back speakers produce no sound. **68**

## ■ The subwoofer produces no sound

When you play source material that contains no information in the LFE channel, the subwoofer produces no sound. —

Make sure the speakers are configured correctly. **44**

## ■ There’s no sound with a certain signal format

Check the digital audio output setting on the connected device. On some game consoles, such as those that support DVD, the default setting is off. —

With some DVD-Video discs, you need to select an audio output format from a menu. —

Depending on the input signal, some listening modes cannot be selected. **36–40**

## ■ Can’t select the Pure Audio listening mode

The Pure Audio listening mode cannot be selected while Zone 2 is on. —

## ■ Can’t get 6.1/7.1 playback

If no surround back speakers, front wide and front high speakers are connected, or the Zone 2 speakers are being used, 6.1/7.1 playback is not possible. —

You can not always select all of the listening modes, depending on the number of the speakers connected. **36–40**

## ■ The speaker volume cannot be set as required (The volume cannot be set to 100.0(MAX))

Check to see if a maximum volume has been set. **53**

If the volume level of each individual speaker has been adjusted to high positive values, then the maximum master volume possible may be reduced. Note that the individual speaker volume levels are set automatically after Audyssey MultEQ® Room Correction and Speaker Setup function has been completed. **29, 45**

## ■ Noise can be heard

Using cable ties to bundle audio cables with power cords, speaker cables, and so on may degrade the audio performance, so don’t do it. —

An audio cable may be picking up interference. Try repositioning your cables. —

## ■ The Late Night function doesn’t work

Make sure the source material is Dolby Digital, Dolby Digital Plus, and Dolby TrueHD. **57**

## ■ About DTS signals

When DTS program material ends and the DTS bitstream stops, the AV receiver remains in DTS listening mode and the **DTS** indicator remains on. This is to prevent noise when you use the pause, fast forward, or fast reverse function on your player. If you switch your player from DTS to PCM, because the AV receiver does not switch formats immediately, you may not hear any sound, in which case you should stop your player for about three seconds, and then resume playback.

With some CD and LD players, you won’t be able to playback DTS material properly even though your player is connected to a digital input on the AV receiver. This is usually because the DTS bitstream has been processed (e.g., output level, sampling rate, or frequency response changed) and the AV receiver doesn’t recognize it as a genuine DTS signal. In such cases, you may hear noise. —

When playing DTS program material, using the pause, fast forward, or fast reverse function on your player may produce a short audible noise. This is not a malfunction. —

## ■ The beginning of audio received by an HDMI IN can't be heard

Since it takes longer to identify the format of an HDMI signal than it does for other digital audio signals, audio output may not start immediately. —

## Video

### ■ There's no picture

Make sure that all video connecting plugs are pushed in all the way. 17

Make sure that each video component is properly connected. 18, 19, 72

If your TV is connected to the **HDMI OUT**, select “- - - -” in the “**HDMI Input**” setup to watch composite video, and component video sources. 42

If the video source is connected to a component video input, you must assign that input to an input selector, and your TV must be connected to either the **HDMI OUT** or **COMPONENT VIDEO MONITOR OUT**. 19, 42

If the video source is connected to a composite video input, your TV must be connected to the **HDMI OUT** or the corresponding composite video output. 19

If the video source is connected to an HDMI input, you must assign that input to an input selector, and your TV must be connected to the **HDMI OUT**. 18, 42

While the Pure Audio listening mode is selected, the video circuitry is turned off and only video signals input through **HDMI IN** can be output. —

On your TV, make sure that the video input to which the AV receiver is connected is selected. —

### ■ There's no picture from a source connected to an HDMI IN

Reliable operation with an HDMI-to-DVI adapter is not guaranteed. In addition, video signals from a PC are not guaranteed. 88

When the Resolution is set to any resolution not supported by the TV, no video is output by the HDMI outputs. 42

If the message “**Resolution Error**” appears on the AV receiver's display, this indicates that your TV does not support the current video resolution and you need to select another resolution on your DVD player. —

### ■ The on-screen menus don't appear

On your TV, make sure that the video input to which the AV receiver is connected is selected. —

When the AV receiver doesn't connect TV with HDMI, onscreen menus are not displayed. —

### ■ The on screen display does not appear

Depending on the input signal, the on screen display may not appear when the input signal from the **HDMI IN** is output to a device connected to the **HDMI OUT**. 53

## Tuner

### ■ Reception is noisy, FM stereo reception is noisy, or the FM STEREO indicator doesn't light

Relocate your antenna. —

Move the AV receiver away from your TV or computer. —

Listen to the station in mono. 32

When listening to an AM station, operating the remote controller may cause noise. —

Passing cars and airplanes can cause interference. —

Concrete walls weaken radio signals. —

If nothing improves the reception, install an outdoor antenna. —

## Remote Controller

### ■ The remote controller doesn't work

Before operating this unit, be sure to press **RECEIVER**. —

Make sure that the batteries are installed with the correct polarity. 4

Install new batteries. Don't mix different types of batteries, or old and new batteries. 4

Make sure that the remote controller is not too far away from the AV receiver, and that there's no obstruction between the remote controller and the AV receiver's remote control sensor. 4

Make sure that the AV receiver is not subjected to direct sunshine or inverter-type fluorescent lights. Relocate if necessary. —

If the AV receiver is installed in a rack or cabinet with colored-glass doors, the remote controller may not work reliably when the doors are closed. —

Make sure you've selected the correct remote controller mode. 11, 78

When using the remote controller to control other manufacturers' AV components, some buttons may not work as expected. —

Make sure you've entered the correct remote control code. 77

Make sure to set the same ID on both the AV receiver and remote controller. 53

### ■ Can't control other components

If it's an Onkyo component, make sure that the **RI** cable and analog audio cable are connected properly. Connecting only an **RI** cable won't work. 20

Make sure you've selected the correct remote controller mode. 11, 78

If you've connected a cassette tape deck, to the **TV/CD IN** jack, or an **RI Dock** to the **TV/CD IN** or **GAME IN** or **VCR/DVR IN** jacks, for the remote controller to work properly, you must set the display. 27

If you cannot operate it, you will need to enter the appropriate remote control code. 76

To control another manufacturer's component, point the remote controller at that component. 77

To control an Onkyo component that's connected via **RI**, point the remote controller at the AV receiver. Be sure to enter the appropriate remote control code first. 77

To control an Onkyo component that's not connected via **RI**, point the remote controller at the component. Be sure to enter the appropriate remote control code first.

The entered remote control code may not be correct. —  
If more than one code is listed, try each one.

### ■ Can't learn commands from another remote controller

When learning commands, make sure that the transmitting ends of both remote controllers are pointing at each other.

Are you trying to learn from a remote controller that cannot be used for learning? Some commands cannot be learned, especially those that contain several instructions.

## Recording

### ■ Can't record

On your recorder, make sure the correct input is selected.

To prevent signal loops and damage to the AV receiver, input signals are not fed through to outputs with the same name (**VCR/DVR IN** to **VCR/DVR OUT**).

When the Pure Audio listening mode is selected, recording is not possible because no video signals are output. Select another listening mode.

## Zone 2

### ■ There's no sound

Only components connected to analog inputs can be played in Zone 2.

### ■ The Zone 2 speakers produce no sound

Powered Zone 2 cannot be used if **"Speakers Type(Front)"** is set to **"Bi-Amp"**. **44**

To use the Zone 2 speakers, you must set the **"Powered Zone2"** setting to **"Act"**. **69**

## Music Server and Internet Radio

### ■ Can't access the server or Internet radio

Check the network connection between the AV receiver and your router or switch.

Make sure that your modem and router are properly connected, and make sure they are both turned on.

Make sure the server is up and running and compatible with the AV receiver. **63, 64**

Check the **"Network Settings"**. **65**

### ■ Playback stops while listening to music files on the server

Make sure your server is compatible with the AV receiver. **63, 64**

If you download or copy large files on your computer, playback may be interrupted. Try closing any unused programs, use a more powerful computer, or use a dedicated server.

If the server is serving large music files to several networked devices simultaneously, the network may become overloaded and playback may be interrupted. Reduce the number of playback devices on the network, upgrade your network, or use a switch instead of a hub.

### ■ Can't connect to the AV receiver from a Web browser

If you're using DHCP, your router may not always allocate the same IP address to the AV receiver, so if you find that you can't connect to a server or Internet radio station, recheck the AV receiver's IP address on Network screen.

Check the **"Network Settings"**. **65**

## USB Mass Storage Device Playback

### ■ Can't access the music files on a USB device

Make sure the USB device is plugged in properly.

The AV receiver supports USB devices that support the USB mass storage device class. However, playback may not be possible with some USB devices even if they conform to the USB mass storage device class.

USB memory devices with security functions cannot be played.

## Others

### ■ Stand-by power consumption

In the following cases, the power consumption could reach a maximum of 50W: **54, 66, 72**

1. You are using the Universal Port jack.
2. **"Control"** is set to **"Enable"** in the **"Network"** setting.
3. **"HDMI Control (RIHD)"** setting is set to **"On"**. (Depending on the TV status, the AV receiver will enter Standby mode as usual.)

### ■ The sound changes when I connect my headphones

When a pair of headphones is connected, the listening mode is set to Stereo, unless it's already set to Stereo, Mono, Direct, or Pure Audio.

### ■ The speaker distance cannot be set as required

In some cases, corrected values suitable for home theater use may be set automatically.

### ■ The display doesn't work

The display is turned off when the Pure Audio listening mode is selected.

### ■ How do I change the language of a multiplex source

Use the **"Multiplex"** setting on the **"Audio Adjust"** **47** menu to select **"Main"** or **"Sub"**.

## ■ The **RI** functions don't work

To use **RI**, you must make an **RI** connection and an analog audio connection (RCA) between the component and AV receiver, even if they are connected digitally. **20**

## ■ The functions **System On/Auto Power On** and **Direct Change** don't work for components connected via **RI**

These functions don't work when Zone 2 is turned on. **20**

## ■ When performing "Audyssey MultEQ® Room Correction and Speaker Setup", the measurement fails showing the message "Ambient noise is too high."

This can be caused by any malfunction in your speaker unit. Check if the unit produces normal sounds. —

## ■ The following settings can be made for the **S-Video** and composite video inputs

You must use the buttons on the unit to make these settings.

1. While holding down the input selector button for the input source that you want to set, press **SETUP**.
2. Use **◀/▶** to change the setting.
3. Press the input selector button for the input source that you want to set when you've finished.

### • **Video Attenuation**

This setting can be made for the **BD/DVD**, **VCR/DVR**, **CBL/SAT**, **GAME**, or **AUX** input.

If you have a games console connected to the composite video input, and the picture isn't very clear, you can attenuate the gain.

**Video ATT:OFF:** (default).

**Video ATT:ON:** Gain reduced by 2dB.

The AV receiver contains a microcomputer for signal processing and control functions. In very rare situations, severe interference, noise from an external source, or static electricity may cause it to lockup. In the unlikely event that this happens, unplug the power cord from the wall outlet, wait at least five seconds, and then plug it back in again.

Onkyo is not responsible for damages (such as CD rental fees) due to unsuccessful recordings caused by the unit's malfunction. Before you record important data, make sure that the material will be recorded correctly.

Before disconnecting the power cord from the wall outlet, set the AV receiver to Standby.

## Important Note Regarding Video Playback

The AV receiver can upconvert component video, S-Video, and composite video sources for display on a TV connected to the **HDMI OUT**. However, if the picture quality of the source is poor, upconversion may make the picture worse or disappear altogether.

In this case, try the following:

### **1** If the video source is connected to a component video input, connect your TV to the **COMPONENT VIDEO MONITOR OUT**.

If the video source is connected to an S-Video input, connect your TV to a **MONITOR OUT S**.

If the video source is connected to a composite video input, connect your TV to **MONITOR OUT V**.

### **2** On the main menu, select "Input/Output Assign", and then select "HDMI Input".

Select the relevant input selector, and assign it to "- - - -" (→ 42).

### **3** On the main menu, select "Input/Output Assign", and then select "Component Video Input" (→ 43):

If the video source is connected to **COMPONENT VIDEO IN 1**, select the relevant input selector, and assign it to "IN1".

If the video source is connected to **COMPONENT VIDEO IN 2**, select the relevant input selector, and assign it to "IN2".

If the video source is connected to an S-Video input or composite video input, select the relevant input selector, and assign it to "- - - -".

### Note

- If "Monitor Out" setting is set to "Analog", press **VCR/DVR** and **RETURN** on the AV receiver at the same time. Select "Skip" in the "VideoProcessor" setting on the display. To reset back to the original setting, press the same button at the same time. If you select "Use", the AV receiver will output video signals from the video processor.

# Specifications

## Amplifier Section

<b>Rated Output Power</b> All channels:	<b>100 watts minimum continuous power per channel, 8 ohm loads, 2 channels driven from 20 Hz to 20 kHz, with a maximum total harmonic distortion of 0.08% (FTC)</b> <b>110 watts minimum continuous power per channel, 8 ohm loads, 2 channels driven at 1 kHz, with a maximum total harmonic distortion of 0.7% (FTC)</b> <b>120 watts minimum continuous power per channel, 6 ohm loads, 2 channels driven at 1 kHz, with a maximum total harmonic distortion of 0.1% (FTC)</b>
<b>Dynamic Power</b>	240 W (3 $\Omega$ , Front) 210 W (4 $\Omega$ , Front) 120 W (8 $\Omega$ , Front)
<b>THD (Total Harmonic Distortion)</b>	0.08% (Power Rated)
<b>Damping Factor</b>	60 (Front, 1 kHz, 8 $\Omega$ )
<b>Input Sensitivity and Impedance</b>	200 mV/47 k $\Omega$ (LINE) 2.5 mV/47 k $\Omega$ (PHONO MM)
<b>Rated RCA Output Level and Impedance</b>	200 mV/470 $\Omega$ (PRE OUT)
<b>Maximum RCA Output Level and Impedance</b>	4.6 V/470 $\Omega$ (PRE OUT)
<b>Phono Overload</b>	70 mV (MM 1 kHz 0.5%)
<b>Frequency Response</b>	5 Hz - 100 kHz/+1 dB, -3 dB (Direct mode)
<b>Tone Control Characteristics</b>	$\pm$ 10 dB, 50 Hz (BASS) $\pm$ 10 dB, 20 kHz (TREBLE)
<b>Signal to Noise Ratio</b>	106 dB (LINE, IHF-A) 80 dB (PHONO, IHF-A)
<b>Speaker Impedance</b>	4 or 6 $\Omega$ - 16 $\Omega$

## Video Section

<b>Input Sensitivity/Output Level and Impedance</b>	1 V <sub>p-p</sub> /75 $\Omega$ (Component and S-Video Y) 0.7 V <sub>p-p</sub> /75 $\Omega$ (Component P <sub>B</sub> /C <sub>B</sub> , P <sub>R</sub> /C <sub>R</sub> ) 0.25 V <sub>p-p</sub> /75 $\Omega$ (S-Video C) 1 V <sub>p-p</sub> /75 $\Omega$ (Composite)
<b>Component Video Frequency Response</b>	5 Hz - 100 MHz/+0 dB, -3 dB

## Tuner Section

<b>FM Tuning Frequency Range</b>	87.5 MHz - 107.9 MHz
<b>AM Tuning Frequency Range</b>	530 kHz - 1710 kHz
<b>Preset Channel</b>	40

## General

<b>Power Supply</b>	AC 120 V, 60 Hz
<b>Power Consumption</b>	6.3 A
<b>Stand-by Power Consumption</b>	0.2 W
<b>Dimensions</b> (W $\times$ H $\times$ D)	435 mm $\times$ 175 mm $\times$ 379 mm 17-1/8" $\times$ 6-7/8" $\times$ 14-15/16"
<b>Weight</b>	12.5 kg (27.6 lbs.)

### ■ HDMI

<b>Input</b>	IN 1, IN 2, IN 3, IN 4, IN 5, AUX INPUT
<b>Output</b>	OUT
<b>Video Resolution</b>	1080p
<b>Audio Format</b>	Dolby TrueHD, DTS Master Audio, DVD-Audio, DSD
<b>Supported</b>	3D, Audio Return Channel, Deep Color, x.v.Color, LipSync, CEC

### ■ Video Inputs

<b>Component</b>	IN 1, IN 2
<b>S-Video</b>	BD/DVD, VCR/DVR, CBL/SAT, GAME
<b>Composite</b>	BD/DVD, VCR/DVR, CBL/SAT, GAME, AUX
<b>Analog RGB input</b>	PC IN

### ■ Video Outputs

<b>Component</b>	MONITOR OUT
<b>S-Video</b>	MONITOR OUT, VCR/DVR OUT
<b>Composite</b>	MONITOR OUT, VCR/DVR OUT

### ■ Audio Inputs

<b>Digital</b>	Optical: 2 Coaxial: 3
<b>Analog</b>	BD/DVD, VCR/DVR, CBL/SAT, GAME, PC, TV/CD, AUX, PHONO
<b>Multichannel Inputs</b>	7.1

### ■ Audio Outputs

<b>Analog</b>	VCR/DVR, PRE OUT, ZONE 2 LINE OUT
<b>Analog Multichannel Pre Outputs</b>	7
<b>Subwoofer Pre Outputs</b>	2
<b>Speaker Outputs</b>	Main (L, R, C, SL, SR, SBL, SBR, FHL, FHR) + ZONE2/Front Wide (L, R)
<b>Phones</b>	1 (6.3 $\phi$ )

### ■ Others

<b>SETUP MIC</b>	1
<b>Ethernet</b>	1
<b>USB</b>	1
<b>Universal Port</b>	1
<b>RI</b>	1

Specifications and features are subject to change without notice.

# About HDMI

---

Designed to meet the increased demands of digital TV, HDMI (High Definition Multimedia Interface) is a new digital interface standard for connecting TVs, projectors, Blu-ray Disc/DVD players, set-top boxes, and other video components. Until now, several separate video and audio cables have been required to connect AV components. With HDMI, a single cable can carry control signals, digital video, and up to eight channels of digital audio (2-channel PCM, multichannel digital audio, and multichannel PCM).

The HDMI video stream (i.e., video signal) is compatible with DVI (Digital Visual Interface)\*1, so TVs and displays with a DVI input can be connected by using an HDMI-to-DVI adapter cable. (This may not work with some TVs and displays, resulting in no picture.)

The AV receiver uses HDCP (High-bandwidth Digital Content Protection)\*2, so only HDCP-compatible components can display the picture.

The AV receiver's HDMI interface is based on the following:

Audio Return Channel, 3D, x.v.Color, Deep Color, Lip Sync, DTS-HD Master Audio, DTS-HD High Resolution Audio, Dolby TrueHD, Dolby Digital Plus, DSD and Multichannel PCM

## Supported Audio Formats

---

- 2-channel linear PCM (32–192 kHz, 16/20/24 bit)
- Multichannel linear PCM (up to 7.1 ch, 32–192 kHz, 16/20/24 bit)
- Bitstream (DSD, Dolby Digital, Dolby Digital Plus, Dolby TrueHD, DTS, DTS-HD High Resolution Audio, DTS-HD Master Audio)

Your Blu-ray Disc/DVD player must also support HDMI output of the above audio formats.

## About Copyright Protection

---

The AV receiver supports HDCP (High-bandwidth Digital Content Protection)\*2, a copy-protection system for digital video signals. Other devices connected to the AV receiver via HDMI must also support HDCP.

\*1 DVI (Digital Visual Interface): The digital display interface standard set by the DDWG\*3 in 1999.

\*2 HDCP (High-bandwidth Digital Content Protection): The video encryption technology developed by Intel for HDMI/DVI. It's designed to protect video content and requires a HDCP-compatible device to display the encrypted video.

\*3 DDWG (Digital Display Working Group): Lead by Intel, Compaq, Fujitsu, Hewlett Packard, IBM, NEC, and Silicon Image, this open industry group's objective is to address the industry's requirements for a digital connectivity specification for high-performance PCs and digital displays.

### Note

- The HDMI video stream is compatible with DVI (Digital Visual Interface), so TVs and displays with a DVI input can be connected by using an HDMI-to-DVI adapter cable. (Note that DVI connections only carry video, so you'll need to make a separate connection for audio.) However, reliable operation with such an adapter is not guaranteed. In addition, video signals from a PC are not supported.
- The HDMI audio signal (sampling rate, bit length, etc.) may be restricted by the connected source component. If the picture is poor or there's no sound from a component connected via HDMI, check its setup. Refer to the connected component's instruction manual for details.



# Using an RIHD-compatible TV, Player, or Recorder

**RIHD**, which stands for Remote Interactive over HDMI, is the name of the system control function found on Onkyo components. The AV receiver can be used with CEC (Consumer Electronics Control), which allows system control over HDMI and is part of the HDMI standard. CEC provides interoperability between various components, however, operation with components other than **RIHD**-compatible components cannot be guaranteed.

## ■ About **RIHD**-compatible components

The following components are **RIHD**-compatible. (As of February 2010) See the Onkyo web site for latest information.

### TV

- Panasonic VIERA Link compatible TV
- Toshiba REGZA-LINK compatible TV
- Sharp TV (See Onkyo web site for latest information on compatible models.)

### Players/Recorders

- Onkyo and Integra **RIHD**-compatible players
- Panasonic VIERA Link compatible players and recorders (only when used together with Panasonic VIERA Link compatible TV)
- Toshiba REGZA-LINK compatible players and recorders (only when used together with Toshiba REGZA-LINK compatible TV)
- Sharp players and recorders (only when used together with Sharp TV)

- \* Models other than those mentioned above may have some interoperability if compatible with CEC which is part of the HDMI Standard, but operation cannot be guaranteed.

### Note

- Do not connect the **RIHD**-compatible component more than the following number to the HDMI input terminal so that the linked operations work properly.
  - Blu-ray Disc/DVD player is up to three.
  - Blu-ray Disc recorder/DVD recorder/Digital Video Recorder is up to three.
  - Cable/Satellite Set-top box is up to four.
- Do not connect the AV receiver to the other AV receiver/AV amplifier via HDMI.
- When the **RIHD**-compatible component more than the above-mentioned is connected, the linked operations are not guaranteed.

## ■ Operations that can be performed with **RIHD** connection

### For **RIHD**-compatible TV

The following linked operation is possible by connecting the AV receiver to an **RIHD**-compatible TV.

- The AV receiver will enter Standby mode when the power of the TV is turned to Standby.
- You can set on the menu screen of the TV to either output the audio from the speakers connected to the AV receiver, or from the speakers of the TV.
- It is possible to output the video/audio from the antenna or from the input jack of the TV from the speakers connected to the AV receiver. (A connection such as optical digital cable or similar is required above the HDMI cable.)
- Input to the AV receiver can be selected with the remote controller of the TV.
- Operations such as volume adjustment or similar for the AV receiver can be performed from the remote controller of the TV.

### For **RIHD**-compatible players/recorders

The following link operation is possible by connecting the AV receiver to an **RIHD**-compatible player/recorder.

- When the playback is started on the player/recorder, input of the AV receiver will switch to the HDMI input of the player/recorder that is playing back.
- Operation of the player/recorder is possible with the remote controller supplied with the AV receiver.

- \* Not all functions may operate depending on the model.

## 1 Confirm the connecting and setting.

1. Connect the **HDMI OUT** jack to the HDMI input jack of the TV.

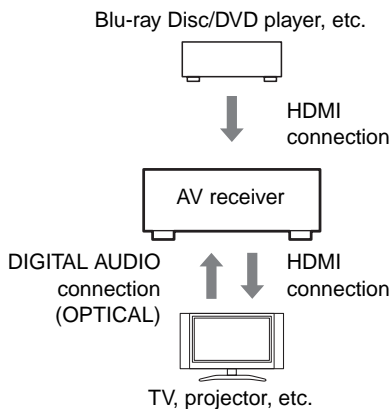

2. Connect the audio output from the TV to the **OPTICAL IN 2** jack of the AV receiver using an optical digital cable.

### Note

- When you use the audio return channel (ARC) function with TV an HDMI (Audio Return Channel) capable TV, this connection is not required (→ 54).
3. Connect the HDMI output of the Blu-ray Disc/DVD player/recorder to the **HDMI IN 1** jack of the AV receiver.

### Note

- It is necessary to assign the HDMI input when connecting the Blu-ray Disc/DVD player/recorder to other jacks (→ 42). Do not assign the components connected to the HDMI IN to the TV/CD input at this time. Appropriate CEC (Consumer Electronics Control) operation can not be guaranteed.

## 2 Change each item in the “HDMI” as below:

- **HDMI Control (RIHD): On**
- **Audio Return Channel (ARC): Auto**
- **Power Control: On**
- **TV Control: On**

See details of each setting (→ 54, 55).

## 3 Confirm the settings.

1. Turn on the power for all connected components.
2. Turn off the power of the TV, and confirm that the power of the connected components is turned off automatically with the link operation.
3. Turn on the power of the Blu-ray Disc/DVD player/recorder.
4. Start playback of the Blu-ray Disc/DVD player/recorder, and confirm the following.
  - The power of the AV receiver is turned on automatically, and input with the Blu-ray Disc/DVD player/recorder connected is selected.
  - The power of the TV is turned on automatically, and input with the AV receiver connected is selected.
5. Following the operating instructions of the TV, select “Use the TV speakers” from the menu screen of the TV, and confirm that the audio is output from the speakers of the TV, and not from the speakers connected to the AV receiver.
6. Select “Use the speakers connected from the AV receiver” from the menu screen of the TV, and confirm that the audio is output from the speakers connected to the AV receiver, and not from the TV speakers.

### Note

- Perform the above operations when you initially use the AV receiver, when the settings of each component are changed, when the main power of each component is turned off, when the power cable is disconnected from the power supply, or when there has been a power outage.

## 4 Operate with the remote controller.

See the list of available buttons (→ 79).

### Note

- Audio from DVD-Audio or Super Audio CD may not output from the TV speakers. You will be able to output the audio from the TV speakers by setting the audio output of the DVD player to 2ch PCM. (It may not be possible depending on the player models.)
- Even if you set to output audio on the TV speakers, audio will be output from the speakers connected to the AV receiver when you adjust the volume or switch the input on the AV receiver. To output audio from the TV speakers, re-do the operations on the TV.
- Do not connect the **RI** cable when connecting to the **RI** and **RI** audio control compatible components.
- When you select anything other than the HDMI jack where the AV receiver is connected as the input on the TV, input on the AV receiver will be switched to “TV/CD”.
- The AV receiver will automatically power on in conjunction when it determines it to be necessary. Even if the AV receiver is connected to an **RIHD** compatible TV or player/recorder, it will not power on if it is not necessary. It may not power on in conjunction when the TV is set to output audio from the TV.
- Linked functions with the AV receiver may not work depending on the model. Operate the AV receiver directly in such cases.

# Video Resolution Chart

The following tables show how video signals at different resolutions are output by the AV receiver.

NTSC/PAL

✓: Output

Output		HDMI					Component					S-Video Composite
		1080p	1080i	720p	480p	480i	1080p	1080i	720p	480p	480i	480i
Input												
HDMI	1080p	✓										
	1080i	✓	✓	✓								
	720p	✓	✓	✓								
	480p	✓	✓	✓	✓							
	480i	✓	✓	✓	✓	✓						
Component	1080p	✓					✓					
	1080i	✓	✓	✓				✓				
	720p	✓	✓	✓					✓			
	480p	✓	✓	✓	✓					✓		
	480i	✓	✓	✓	✓	✓					✓	
S-Video Composite	480i	✓	✓	✓	✓	✓						✓
PC IN (Analog RGB) <sup>*1</sup>		✓	✓	✓	✓							

\*1 Available resolution:  
 [640 × 480 60/72/75 Hz],  
 [800 × 600 56/60/72/75 Hz],  
 [1024 × 768 60/70/75 Hz],  
 [1280 × 1024 60 Hz]

## **ONKYO CORPORATION**

Sales & Product Planning Div. : 2-1, Nisshin-cho, Neyagawa-shi, OSAKA 572-8540, JAPAN  
Tel: 072-831-8023 Fax: 072-831-8163

### **ONKYO U.S.A. CORPORATION**

18 Park Way, Upper Saddle River, N.J. 07458, U.S.A.  
Tel: 800-229-1687, 201-785-2600 Fax: 201-785-2650 <http://www.us.onkyo.com/>

### **ONKYO EUROPE ELECTRONICS GmbH**

Liegnitzerstrasse 6, 82194 Groebenzell, GERMANY  
Tel: +49-8142-4401-0 Fax: +49-8142-4401-555 <http://www.eu.onkyo.com/>

### **ONKYO EUROPE ELECTRONICS GmbH (UK BRANCH)**

The Coach House 81A High Street, Marlow, Buckinghamshire, SL7 1AB, UK  
Tel: +44-(0)1628-473-350 Fax: +44-(0)1628-401-700

### **ONKYO CHINA LIMITED**

Unit 1 & 12, 9/F, Ever Gain Plaza Tower 1, 88, Container Port Road, Kwai Chung,  
N.T., Hong Kong. Tel: 852-2429-3118 Fax: 852-2428-9039  
<http://www.ch.onkyo.com/>

Y1004-1

SN 29400352

(C) Copyright 2010 ONKYO CORPORATION Japan. All rights reserved.



\* 2 9 4 0 0 3 5 2 \*