

ONKYO®

7.1ch Home Theater System

HT-S7100

AV Receiver (TX-SR606)

Instruction Manual

Thank you for purchasing an Onkyo 7.1ch Home Theater System. Please read this manual thoroughly before making connections and plugging in the unit. Following the instructions in this manual will enable you to obtain optimum performance and listening enjoyment from your new 7.1ch Home Theater System.

Please retain this manual for future reference.

Contents

Introduction 2

Connection 14

Turning On & First Time Setup..... 37

Basic Operation

Playing your AV components 47

Listening to the Radio 51

Using the Listening Modes 57

Advanced Operation 67

Troubleshooting 96



WARNING:

TO REDUCE THE RISK OF FIRE OR ELECTRIC SHOCK, DO NOT EXPOSE THIS APPARATUS TO RAIN OR MOISTURE.

CAUTION:

TO REDUCE THE RISK OF ELECTRIC SHOCK, DO NOT REMOVE COVER (OR BACK). NO USER-SERVICEABLE PARTS INSIDE. REFER SERVICING TO QUALIFIED SERVICE PERSONNEL.



WARNING
RISK OF ELECTRIC SHOCK
DO NOT OPEN

AVIS
RISQUE DE CHOC ELECTRIQUE
NE PAS OUVRIR



The lightning flash with arrowhead symbol, within an equilateral triangle, is intended to alert the user to the presence of uninsulated “dangerous voltage” within the product’s enclosure that may be of sufficient magnitude to constitute a risk of electric shock to persons.



The exclamation point within an equilateral triangle is intended to alert the user to the presence of important operating and maintenance (servicing) instructions in the literature accompanying the appliance.

Important Safety Instructions

1. Read these instructions.
2. Keep these instructions.
3. Heed all warnings.
4. Follow all instructions.
5. Do not use this apparatus near water.
6. Clean only with dry cloth.
7. Do not block any ventilation openings. Install in accordance with the manufacturer’s instructions.
8. Do not install near any heat sources such as radiators, heat registers, stoves, or other apparatus (including amplifiers) that produce heat.
9. Do not defeat the safety purpose of the polarized or grounding-type plug. A polarized plug has two blades with one wider than the other. A grounding type plug has two blades and a third grounding prong. The wide blade or the third prong are provided for your safety. If the provided plug does not fit into your outlet, consult an electrician for replacement of the obsolete outlet.
10. Protect the power cord from being walked on or pinched particularly at plugs, convenience receptacles, and the point where they exit from the apparatus.
11. Only use attachments/accessories specified by the manufacturer.
12. Use only with the cart, stand, tripod, bracket, or table specified by the manufacturer, or sold with the apparatus. When a cart is used, use caution when moving the cart/apparatus combination to avoid injury from tip-over.

PORTABLE CART WARNING
S3125A
13. Unplug this apparatus during lightning storms or when unused for long periods of time.
14. Refer all servicing to qualified service personnel. Servicing is required when the apparatus has been damaged in any way, such as power-supply cord or plug is damaged, liquid has been spilled or objects have fallen into the apparatus, the apparatus has been exposed to rain or moisture, does not operate normally, or has been dropped.
15. Damage Requiring Service
Unplug the apparatus from the wall outlet and refer servicing to qualified service personnel under the following conditions:
 - A. When the power-supply cord or plug is damaged,
 - B. If liquid has been spilled, or objects have fallen into the apparatus,
 - C. If the apparatus has been exposed to rain or water,
 - D. If the apparatus does not operate normally by following the operating instructions. Adjust only those controls that are covered by the operating instructions as an improper adjustment of other controls may result in damage and will often require extensive work by a qualified technician to restore the apparatus to its normal operation,
 - E. If the apparatus has been dropped or damaged in any way, and
 - F. When the apparatus exhibits a distinct change in performance this indicates a need for service.
16. Object and Liquid Entry
Never push objects of any kind into the apparatus through openings as they may touch dangerous voltage points or short-out parts that could result in a fire or electric shock.
The apparatus shall not be exposed to dripping or splashing and no objects filled with liquids, such as vases shall be placed on the apparatus.
Don’t put candles or other burning objects on top of this unit.
17. Batteries
Always consider the environmental issues and follow local regulations when disposing of batteries.
18. If you install the apparatus in a built-in installation, such as a bookcase or rack, ensure that there is adequate ventilation.
Leave 20 cm (8") of free space at the top and sides and 10 cm (4") at the rear. The rear edge of the shelf or board above the apparatus shall be set 10 cm (4") away from the rear panel or wall, creating a flue-like gap for warm air to escape.

Precautions

1. **Recording Copyright**—Unless it's for personal use only, recording copyrighted material is illegal without the permission of the copyright holder.
2. **AC Fuse**—The AC fuse inside the unit is not user-serviceable. If you cannot turn on the unit, contact your Onkyo dealer.
3. **Care**—Occasionally you should dust the unit all over with a soft cloth. For stubborn stains, use a soft cloth dampened with a weak solution of mild detergent and water. Dry the unit immediately afterwards with a clean cloth. Don't use abrasive cloths, thinners, alcohol, or other chemical solvents, because they may damage the finish or remove the panel lettering.

4. Power

WARNING

BEFORE PLUGGING IN THE UNIT FOR THE FIRST TIME, READ THE FOLLOWING SECTION CAREFULLY.

AC outlet voltages vary from country to country. Make sure that the voltage in your area meets the voltage requirements printed on the unit's rear panel (e.g., AC 230 V, 50 Hz or AC 120 V, 60 Hz).

The power cord plug is used to disconnect this unit from the AC power source. Make sure that the plug is readily operable (easily accessible) at all times.

Some models have a voltage selector switch for compatibility with power systems around the world. Before you plug in this model, make sure that the voltage selector is set to the correct voltage for your area. If it isn't, use a small screwdriver to set it as appropriate. For example, if the voltage in your area is 120 volts, set the selector to "120V." If it's between 220 and 240 volts, set it to "220-240V."

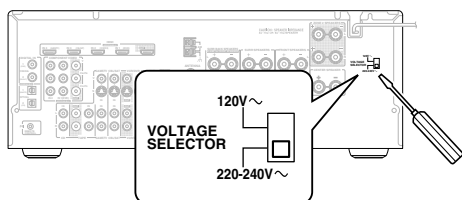

Pressing the [ON/STANDBY] button to select Standby mode does not fully shutdown the unit. If you do not intend to use the unit for an extended period, remove the power cord from the AC outlet.

5. Preventing Hearing Loss

Caution

Excessive sound pressure from earphones and headphones can cause hearing loss.

6. Batteries and Heat Exposure

Warning

Batteries (battery pack or batteries installed) shall not be exposed to excessive heat as sunshine, fire or the like.

7. **Never Touch this Unit with Wet Hands**—Never handle this unit or its power cord while your hands are wet or damp. If water or any other liquid gets inside this unit, have it checked by your Onkyo dealer.

8. Handling Notes

- If you need to transport this unit, use the original packaging to pack it how it was when you originally bought it.

- Do not leave rubber or plastic items on this unit for a long time, because they may leave marks on the case.
- This unit's top and rear panels may get warm after prolonged use. This is normal.
- If you do not use this unit for a long time, it may not work properly the next time you turn it on, so be sure to use it occasionally.

For U.S. models

FCC Information for User

CAUTION:

The user changes or modifications not expressly approved by the party responsible for compliance could void the user's authority to operate the equipment.

NOTE:

This equipment has been tested and found to comply with the limits for a Class B digital device, pursuant to Part 15 of the FCC Rules. These limits are designed to provide reasonable protection against harmful interference in a residential installation.

This equipment generates, uses and can radiate radio frequency energy and, if not installed and used in accordance with the instructions, may cause harmful interference to radio communications. However, there is no guarantee that interference will not occur in a particular installation. If this equipment does cause harmful interference to radio or television reception, which can be determined by turning the equipment off and on, the user is encouraged to try to correct the interference by one or more of the following measures:

- Reorient or relocate the receiving antenna.
- Increase the separation between the equipment and receiver.
- Connect the equipment into an outlet on a circuit different from that to which the receiver is connected.
- Consult the dealer or an experienced radio/TV technician for help.

For Canadian Models

NOTE: THIS CLASS B DIGITAL APPARATUS COMPLIES WITH CANADIAN ICES-003.

For models having a power cord with a polarized plug:

CAUTION: TO PREVENT ELECTRIC SHOCK, MATCH WIDE BLADE OF PLUG TO WIDE SLOT, FULLY INSERT.

Modèle pour les Canadiens

REMARQUE: CET APPAREIL NUMÉRIQUE DE LA CLASSE B EST CONFORME À LA NORME NMB-003 DU CANADA.

Sur les modèles dont la fiche est polarisée:

ATTENTION: POUR ÉVITER LES CHOCS ÉLECTRIQUES, INTRODUIRE LA LAME LA PLUS LARGE DE LA FICHE DANS LA BORNE CORRESPONDANTE DE LA PRISE ET POUSSER JUSQU'AU FOND.

Precautions—Continued

For British models

Replacement and mounting of an AC plug on the power supply cord of this unit should be performed only by qualified service personnel.

IMPORTANT

The wires in the mains lead are coloured in accordance with the following code:

Blue: Neutral

Brown: Live

As the colours of the wires in the mains lead of this apparatus may not correspond with the coloured markings identifying the terminals in your plug, proceed as follows:

The wire which is coloured blue must be connected to the terminal which is marked with the letter N or coloured black.

The wire which is coloured brown must be connected to the terminal which is marked with the letter L or coloured red.

IMPORTANT

The plug is fitted with an appropriate fuse. If the fuse needs to be replaced, the replacement fuse must be approved by ASTA or BSI to BS1362 and have the same ampere rating as that indicated on the plug. Check for the ASTA mark or the BSI mark on the body of the fuse. If the power cord's plug is not suitable for your socket outlets, cut it off and fit a suitable plug. Fit a suitable fuse in the plug.

For European Models

Declaration of Conformity

We, ONKYO EUROPE
ELECTRONICS GmbH
LIEGNITZERSTRASSE 6,
82194 GROEBENZELL,
GERMANY



declare in own responsibility, that the ONKYO product described in this instruction manual is in compliance with the corresponding technical standards such as EN60065, EN55013, EN55020 and EN61000-3-2, -3-3.

GROEBENZELL, GERMANY

K. MIYAGI

ONKYO EUROPE ELECTRONICS GmbH

Supplied Accessories

Make sure you have the following accessories:

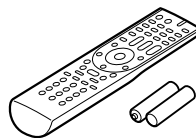

Remote controller and two batteries (AA/R6)



Speaker setup microphone



Indoor FM antenna

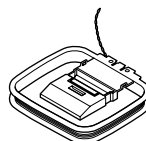

AM loop antenna

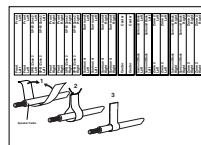

Speaker cable labels

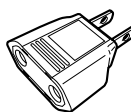

Power-plug adapter

Only supplied in certain countries. Use this adapter if your AC outlet does not match with the plug on the AV receiver's power cord. (Adapter varies from country to country.)

*How to mount the AC plug:

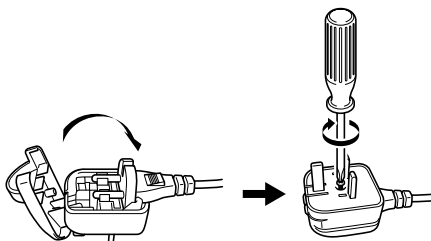

* In catalogs and on packaging, the letter at the end of the product name indicates the color. Specifications and operation are the same regardless of color.

Contents

Important Safety Instructions	2	Common Functions	48
Precautions	3	Setting the Display Brightness	48
Supplied Accessories	4	Muting the AV Receiver	48
Features	6	Using the Sleep Timer	48
Multiroom Capability	7	Using Headphones	49
Getting to Know the AV Receiver	8	Displaying Source Information	49
Front Panel	8	Specifying the Digital Signal Format	50
Display	9	Listening to the Radio	51
Rear Panel	10	AM Frequency Step Setup (on some models)	51
Remote Controller	12	Listening to AM/FM Stations	52
Controlling the AV Receiver	12	Presetting AM/FM Stations	54
Installing the Batteries	13	Using RDS (European models only)	55
Using the Remote Controller	13	Using the Listening Modes	57
Connecting Your Speakers	14	Selecting the Listening Modes	57
Enjoying Home Theater	14	Listening Modes Available for Each	
Bi-amping Front Speakers	17	Source Format	58
Connecting Antennas	18	About the Listening Modes	64
Connecting the Indoor FM Antenna	18	Recording	66
Connecting the AM Loop Antenna	18	Recording the Input Source	66
Connecting an Outdoor FM Antenna	19	Recording from Different AV Sources	66
Connecting an Outdoor AM Antenna	19	Adjusting the Listening Modes	67
Connecting Your Components	20	Using the Audio Adjust Settings	67
About AV Connections	20	Using the Audio Settings	69
Connecting Audio and Video Signals		Listening Mode Presets	71
to the AV Receiver	21	Advanced Setup	72
Which Connections Should I Use?	21	Speaker Setup	72
Connecting a TV or Projector	23	Source Setup	77
Connecting a DVD player	24	Miscellaneous Setup	78
Connecting a VCR or DVR for Playback	26	Hardware Setup	79
Connecting a VCR or DVR for Recording	27	Lock Setup	82
Connecting a Satellite, Cable, Terrestrial		Zone 2	83
Set-top box, or Other Video Source	28	Connecting Zone 2	83
Connecting a Game Console	29	Powered Zone 2 Setting	84
Connecting Components with HDMI	30	Using Zone 2	85
Making HDMI Connections	31	Controlling Other Components	87
Connecting a Camcorder or Other Device	32	Preprogrammed Remote Control Codes	87
Connecting a CD Player or Turntable	33	Entering Remote Control Codes	87
Connecting a Cassette, CDR, MiniDisc,		Resetting the Remote Controller	88
or DAT Recorder	34	Controlling a TV	89
Connecting an RI Dock	35	Controlling a DVD Player, or DVD Recorder	90
Connecting Onkyo RI Components	36	Controlling a VCR or PVR	91
Turning On the AV Receiver	37	Controlling a Satellite Receiver	
Connecting the Power Cord	37	or Cable Receiver	92
Turning On and Standby	37	Controlling a CD Player, CD Recorder,	
First Time Setup	38	or MD Player	93
Automatic Speaker Setup	38	Controlling an RI Dock	94
Speaker Settings	42	Controlling a Cassette Recorder	95
HDMI Input Setup	43	Troubleshooting	96
Component Video Input Setup	44	Specifications	101
Digital Input Setup	44	Video Resolution Chart	102
Changing the Input Display	45	Onscreen Setup Menus	103
Automatic Audio Input Selection Setup	46		
Playing Your AV Components	47		
Basic AV Receiver Operation	47		

* To reset the AV receiver to its factory defaults, turn it on and, while holding down the [VCR/DVR] button, press the [ON/STANDBY] button (see page 96).

Features

Amplifier

- 90 Watts/Channel @ 8 ohms (FTC)
- 140 Watts/Channel @ 6 ohms (IEC)
- 175 Watts/Channel @ 6 ohms (JEITA)
- WRAT-Wide Range Amplifier Technology (5Hz–100kHz bandwidth)
- Optimum Gain Volume Circuitry

Processing

- HDMI Video Upscaling (Up to 1080i)
- HDMI Video Upconversion
- Dolby TrueHD^{*1}
- DTS-HD Master Audio^{*2}
- Faroudja DCDi Edge Enhancement
- Pure Audio Mode (On models other than the North American model)
- Direct Mode
- Music Optimizer^{*3} for Compressed Music
- CinemaFILTER
- Non-Scaling Configuration
- A-Form Listening Mode Memory
- 24-bit/192kHz D/A Converters
- Powerful and Highly Accurate 32-bit DSP Processing

Connections

- 4 HDMI^{*4} Inputs and 1 Output
- Onkyo RIHD^{*5} for System Control
- HDTV-Ready Component Video Switching (2 Inputs/1 Output)
- 4 Digital Inputs (2 Optical/2 Coaxial/4 Assignable)
- 4 S-Video Inputs/2 Outputs
- Powered Zone 2
- Color-Coded 7.1 Multichannel Inputs
- Bi-Amp Connectable for Front L/R with Surround Back L/R

Miscellaneous

- 40 Sirius^{*6}/AM/FM Presets (North American model)
- 40 AM/FM Presets (Other models)
- Audyssey 2EQ^{*7} Room Correction and Speaker Calibration
- Audyssey Dynamic EQ^{*7} Loudness Correction
- Crossover Adjustment (40/50/60/80/100/120/150/200Hz)
- A/V Sync Control Function (up to 100 ms)
- On-Screen Display
- Compatible with RI Dock for the iPod
- Aluminum Front Panel
- Preprogrammed **RI**-Compatible Remote



Manufactured under license from Dolby Laboratories. Dolby, Pro Logic, and the double-D symbol are trademarks of Dolby Laboratories.



Manufactured under license under U.S. Patent #'s: 5,451,942; 5,956,674; 5,974,380; 5,978,762; 6,226,616; 6,487,535 & other U.S. and worldwide patents issued & pending. DTS is a registered trademark and the DTS logos, Symbol, DTS-HD and DTS-HD Master Audio are trademarks of DTS, Inc.



“DTS” and “DTS-ES | Neo: 6” are registered trademarks of DTS, Inc. “96/24” is a trademark of DTS, Inc.

*3 Music Optimizer™ is a trademark of Onkyo Corporation.



HDMI, the HDMI logo and High Definition Multimedia Interface are trademarks or registered trademarks of HDMI Licensing, LLC.



RIHD is a trademark of Onkyo Corporation.



©2005 SIRIUS Satellite Radio Inc. “SIRIUS,” SiriusConnect, the SIRIUS dog logo, channel names and logos are trademarks of SIRIUS Satellite Radio Inc. Available only in the contiguous United States (excluding Alaska and Hawaii) and Canada.



Manufactured under license from Audyssey Laboratories. U.S. and foreign patents pending. Audyssey 2EQ and Dynamic EQ are trademarks of Audyssey Laboratories.

* Apple and iPod are trademarks of Apple Computer, Inc., registered in the U.S. and other countries.

* “x.v.Color” is a trademark of Sony Corporation.

This product incorporates copyright protection technology that is protected by U.S. patents and other intellectual property rights. Use of this copyright protection technology must be authorized by Macrovision Corporation, and is intended for home and other limited consumer uses only unless otherwise authorized by Macrovision. Reverse engineering or disassembly is prohibited.

Multiroom Capability

You can use two speaker systems with this AV receiver—a surround-sound speaker system (up to 7.1 channels) in your main listening room, a stereo speaker system in a second room, or Zone 2, as we call it. And, you can select a different audio source for each room.

Main Room: In your main listening room, you can enjoy up to 7.1-channel playback (see page 14).

You can enjoy the various listening modes such as Dolby and DTS (pages 57–65).

*While Powered Zone 2 is being used, playback is reduced to 5.1-channels (see page 83).

Zone 2: In your Zone 2 room, you can enjoy 2-channel stereo playback (see page 83).

*The listening modes cannot be used with Zone 2.

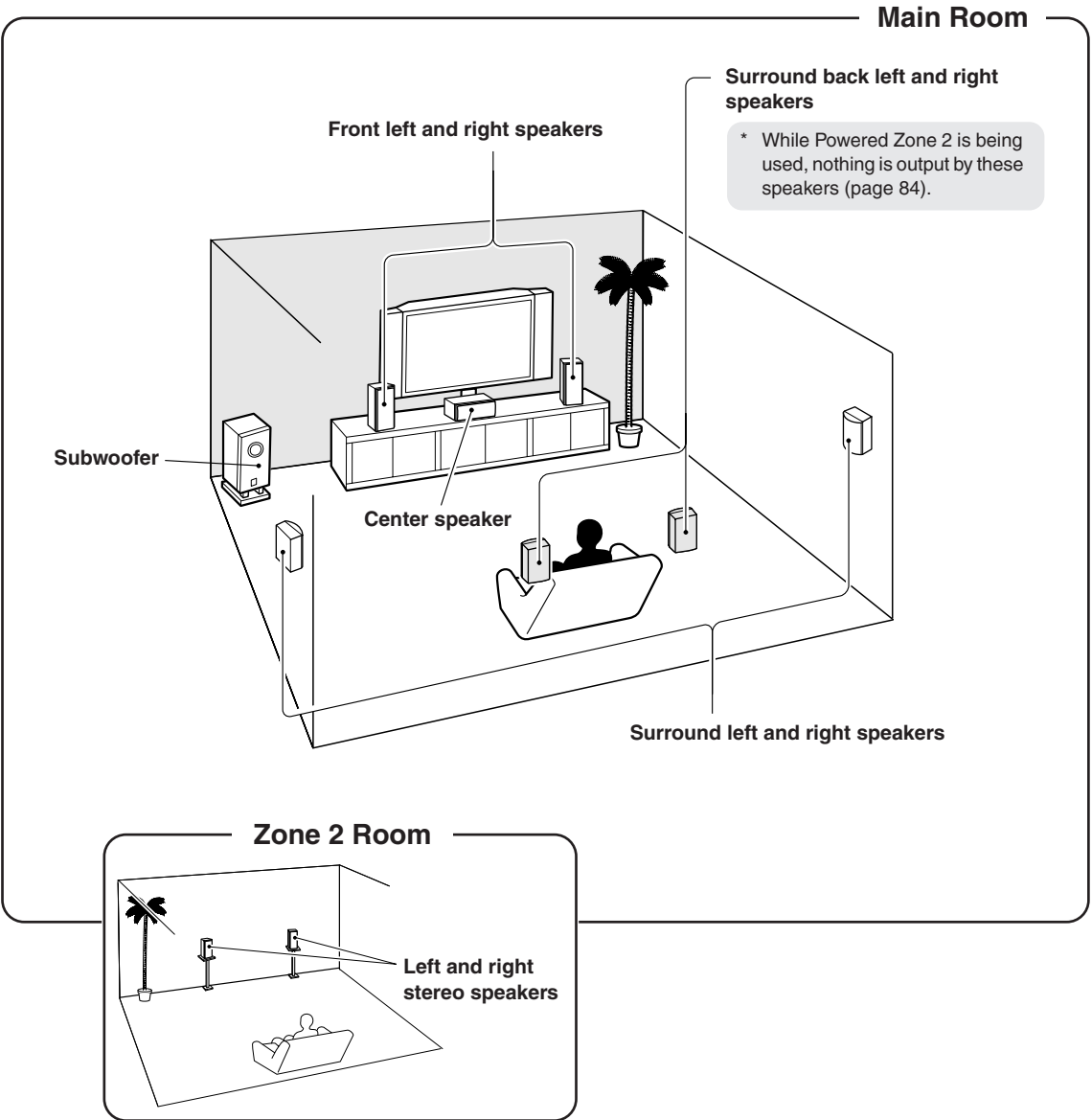

Getting to Know the AV Receiver

Front Panel

North American model

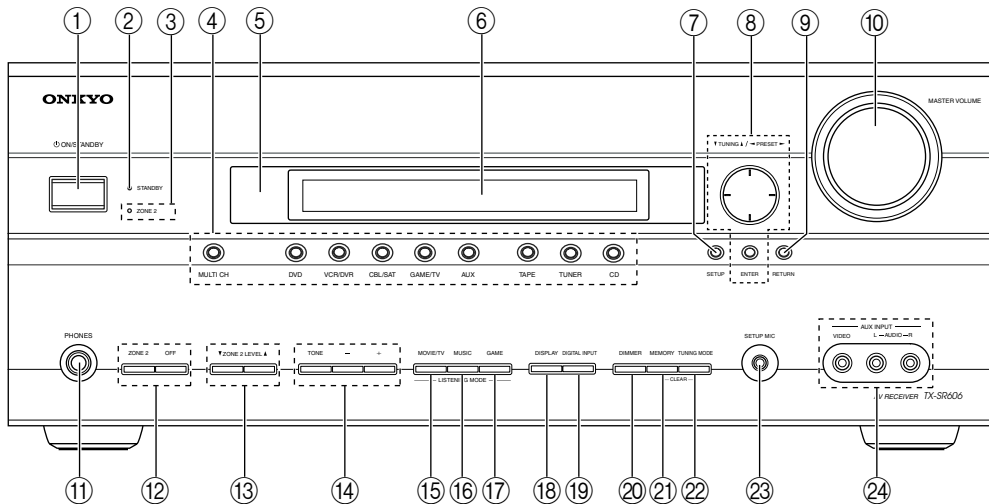

Other models

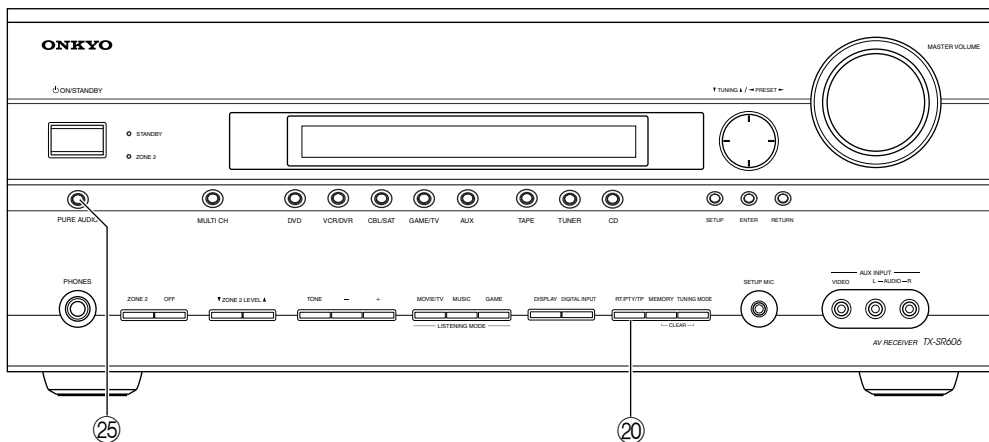

The actual front panel has various logos printed on it. They are not shown here for clarity. The page numbers in parentheses show where you can find the main explanation for each item.

- ① **ON/STANDBY button (37)**
Sets the AV receiver to On or Standby.
- ② **STANDBY indicator (37)**
Lights up when the AV receiver is on Standby and flashes while a signal is being received from the remote controller.
- ③ **ZONE 2 indicator (85)**
Flashes when Zone 2 is being set. Lights up when Zone 2 is on.
- ④ **Input selector buttons (47)**
Select the following input sources: DVD, VCR/DVR, CBL/SAT, GAME/TV, AUX, TAPE, TUNER, CD.
The [MULTI CH] button selects the multichannel DVD input.
- ⑤ **Remote-control sensor (13)**
Receives control signals from the remote controller.
- ⑥ **Display**
See “Display” on page 9.
- ⑦ **SETUP button**
Opens and closes the setup menus.
- ⑧ **TUNING, PRESET, Arrow, and ENTER buttons**
When AM or FM is selected, the TUNING [▲] [▼] buttons are used for radio tuning, and the PRESET [◀] [▶] buttons are used to select radio presets (see page 54). With the setup menus, they work as arrow buttons and are used to select and set items. The ENTER button is also used with the setup menus.

Getting to Know the AV Receiver—Continued

For detailed information, see the pages in parentheses.

- ⑨ **RETURN button**
Selects the previously displayed setup menu.
- ⑩ **MASTER VOLUME control (47)**
Sets the volume of the AV receiver to Min, 1 through 79, or Max.
- ⑪ **PHONES jack (49)**
This 1/4-inch phone jack is for connecting a standard pair of stereo headphones for private listening.
- ⑫ **ZONE 2 and OFF buttons (85)**
The ZONE 2 button is used when setting Zone 2. The OFF button is used to turn off Zone 2.
- ⑬ **ZONE 2 LEVEL button (86)**
Used when adjusting the volume level of Zone 2.
- ⑭ **TONE, –, and + buttons (69)**
Used to adjust the tone (bass and treble).
- ⑮ **MOVIE/TV button (57)**
Selects the listening modes intended for use with movies and TV.
- ⑯ **MUSIC button (57)**
Selects the listening modes intended for use with music.
- ⑰ **GAME button (57)**
Selects the listening modes intended for use with video games.
- ⑱ **DISPLAY button (49)**
Displays various information about the currently selected input source.
- ⑲ **DIGITAL INPUT button (46)**
Selects the options for automatic audio input selection setup.
- ⑳ **DIMMER (RT/PTY/TP) button (48, 56)**
Adjusts the display brightness.
On the European modes, this is the RT/PTY/TP button, and it's used with RDS (Radio Data System). See "Using RDS (European models only)" on page 55.
- ㉑ **MEMORY button (54)**
Used when storing or deleting radio presets.
- ㉒ **TUNING MODE button (52)**
Selects the Auto or Manual tuning mode for AM and FM radio.
- ㉓ **SETUP MIC (38)**
The automatic speaker setup microphone connects here.
- ㉔ **AUX INPUT (32, 66)**
Used to connect a camcorder, game console, and so on. There are input jacks for composite video and analog audio.
- ㉕ **PURE AUDIO button (57)**
On models other than the North American model, selects the Pure Audio listening mode. The indicator lights up when this mode is selected. Pressing this button again selects the previous listening mode.

Display

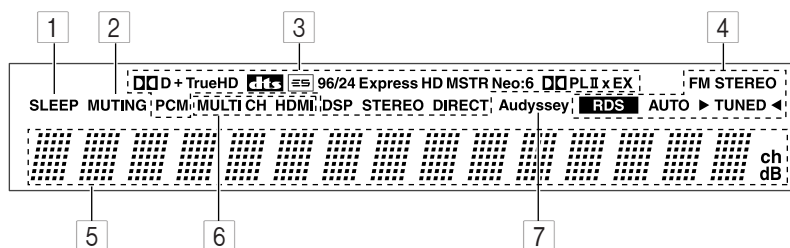

For detailed information, see the pages in parentheses.

- ① **SLEEP indicator (48)**
Lights up when the Sleep function has been set.
- ② **MUTING indicator (48)**
Flashes while the AV receiver is muted.
- ③ **Listening mode and format indicators (57)**
Show the selected listening mode and audio input signal format.
- ④ **Tuning indicators (52)**
FM STEREO (52): Lights up when tuned to a stereo FM station.
RDS (55): Lights up when tuned to a radio station that supports RDS (Radio Data System).
- AUTO (52):** Lights up when Auto Tuning mode is selected for AM or FM radio. Goes off when Manual Tuning mode is selected.
- TUNED (52):** Lights up when tuned to a radio station.
- ⑤ **Message area**
Displays various information.
- ⑥ **Audio input indicators**
Indicate the type of audio input that's selected as the audio source: MULTI CH, or HDMI.
- ⑦ **Audyssey indicator**
Flashes during automatic speaker setup.

Rear Panel

North American model

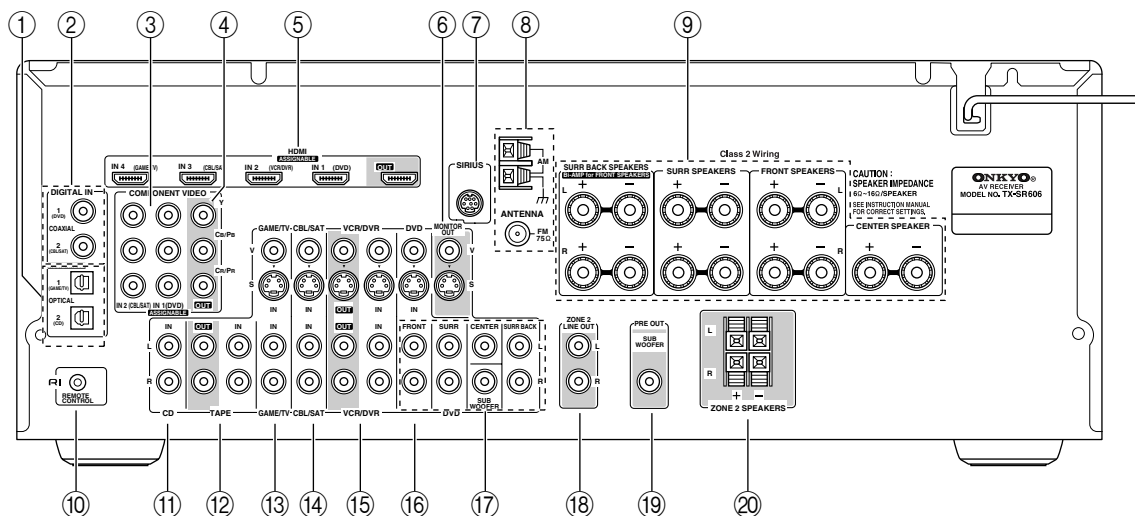

① DIGITAL IN OPTICAL 1 and 2

These optical digital audio inputs are for connecting components with an optical digital audio output, such as a CD player or DVD player. They're assignable, which means you can assign each one to an input selector to suit your setup. See "Digital Input Setup" on page 44.

② DIGITAL IN COAXIAL 1 and 2

These coaxial digital audio inputs are for connecting components with a coaxial digital audio output, such as a CD player or DVD player. They're assignable, which means you can assign each one to an input selector to suit your setup. See "Digital Input Setup" on page 44.

③ COMPONENT VIDEO IN 1 and 2

These RCA component video inputs are for connecting components with a component video output, such as a DVD player, DVD recorder, or DVR (digital video recorder). They're assignable, which means you can assign each one to an input selector to suit your setup. See "Component Video Input Setup" on page 44.

④ COMPONENT VIDEO OUT

This RCA component video output is for connecting a TV or projector with a component video input.

⑤ HDMI IN 1–4 and OUT

HDMI (High Definition Multimedia Interface) connections carry digital audio and digital video.

The HDMI inputs are for connecting components with an HDMI output, such as a DVD player, DVD recorder, or DVR (digital video recorder). They're assignable, which means you can assign each one to

an input selector to suit your setup. See "HDMI Input Setup" on page 43.

The HDMI outputs are for connecting a TV or projector with an HDMI input.

⑥ MONITOR OUT

The S-Video or composite video jack should be connected to a video input on your TV or projector.

⑦ SIRIUS antenna (on North American model)

This jack is for connecting a SIRIUS digital antenna, sold separately (see the separate SIRIUS instructions).

⑧ AM and FM ANTENNA

The AM push terminals are for connecting an AM antenna. The FM jack is for connecting an FM antenna.

⑨ FRONT L/R, CENTER, SURR L/R, and SURR BACK L/R SPEAKERS

These terminal posts are for connecting the front speakers, center, surround, and surround back speakers.

The FRONT L/R and SURR BACK L/R terminal posts can be used with front speakers and surround back speakers, respectively, or used to bi-amp front Speakers. See "Bi-amping Front Speakers" on page 17.

⑩ RI REMOTE CONTROL

This **RI** (Remote Interactive) jack can be connected to the **RI** jack on another **RI**-capable Onkyo component for remote and system control.

To use **RI**, you must make an analog audio connection (RCA) between the AV receiver and the other component, even if they are connected digitally.

Getting to Know the AV Receiver—Continued

Other models

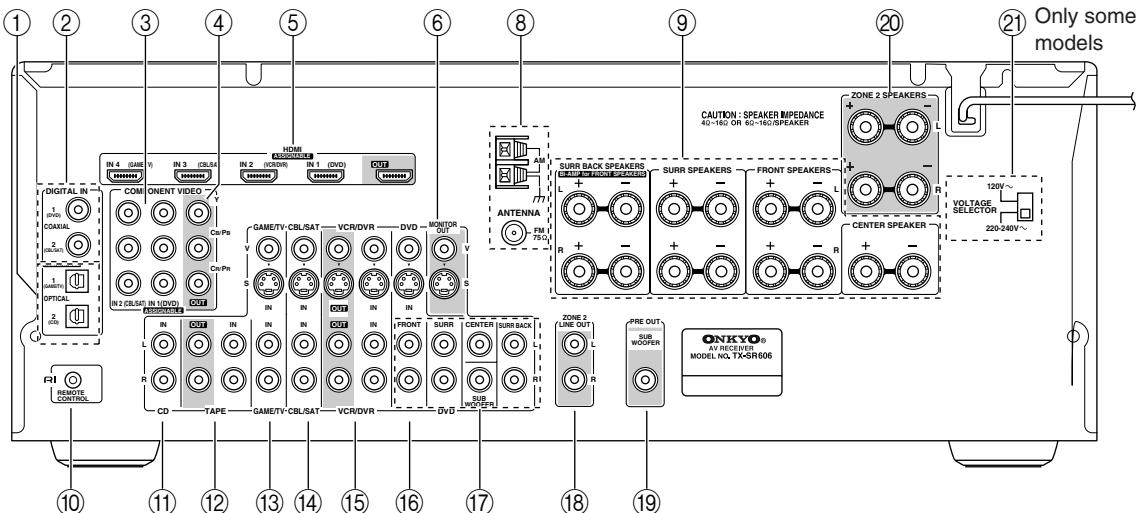

11 CD IN

This analog audio input is for connecting a CD player's analog audio output.

12 TAPE IN/OUT

These analog audio input and output jacks are for connecting a recorder with an analog audio input and output, such as a cassette deck, MD recorder, etc.

13 GAME/TV IN

A game console or TV output can be connected here. There's S-Video and composite video input jacks for connecting the video signal.

14 CBL/SAT IN

A cable or satellite receiver can be connected here. There are S-Video and composite video input jacks for connecting the video signal, and there are analog audio input jacks for connecting the audio signal.

15 VCR/DVR IN/OUT

A video component, such as a VCR or DVR, can be connected here for recording and playback. There are S-Video and composite video input and output jacks for connecting the video signal, and there are analog audio input jacks for connecting the audio signal.

16 DVD IN

This input is for connecting a DVD player. There are S-Video and composite video input jacks for connecting the video signal.

17 DVD FRONT L/R, CENTER, SUBWOOFER, SURR L/R, and SURR BACK L/R

This analog multichannel input is for connecting a component with a 5.1/7.1-channel analog audio output, such as a DVD player, DVD-Audio or SACD-capable player, or an MPEG decoder.

18 ZONE 2 LINE OUT L/R

These analog audio outputs can be connected to the line inputs on amplifiers in Zone 2.

19 SUBWOOFER PRE OUT

This analog audio output can be connected to a powered subwoofer.

20 ZONE 2 SPEAKERS L/R

These push terminals are for connecting speakers in Zone 2.

21 VOLTAGE SELECTOR (Only some models)

This voltage selector provides compatibility with power systems around the world (see page 3).

See pages 14–36 for hookup information.

Remote Controller

Controlling the AV Receiver

To control the AV receiver, press the **[RECEIVER] REMOTE MODE button** to select Receiver mode. You can also use the remote controller to control your DVD player, CD player, and other components. See page 87 for more details.

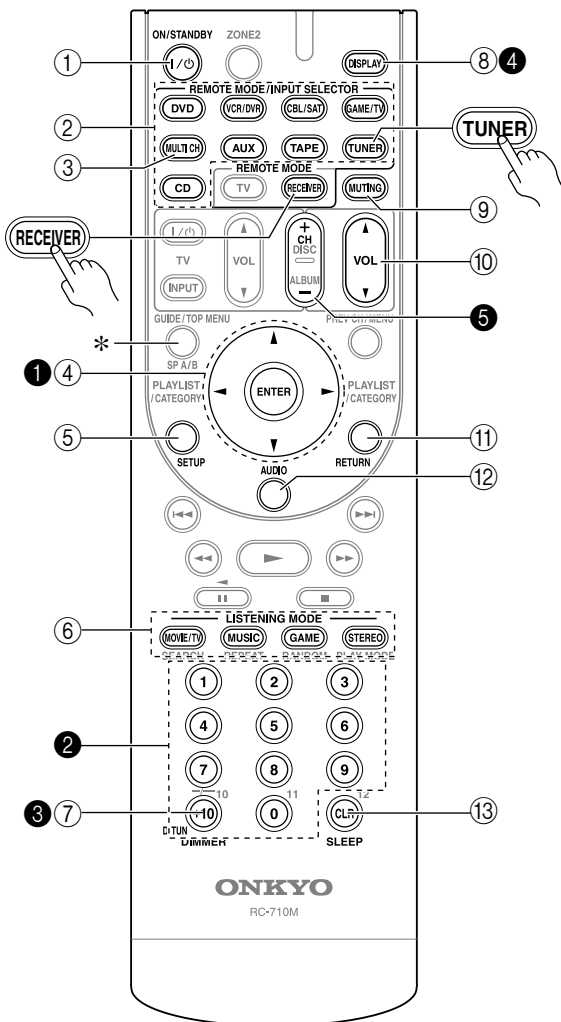

For detailed information, see the pages in parentheses.

- ① **ON/STANDBY button (37)**
Sets the AV receiver to On or Standby.
- ② **REMOTE MODE/INPUT SELECTOR buttons (47, 89–95)**
Selects the remote controller modes and the input sources.

- ③ **MULTI CH button (47)**
Selects the multichannel DVD input.
- ④ **Arrow [▲]/[▼]/[◀]/[▶] and ENTER buttons**
Used to select and adjust settings.
- ⑤ **SETUP button**
Used to change settings.
- ⑥ **LISTENING MODE buttons (57)**
Used to select the listening modes.
- ⑦ **DIMMER button (48)**
Adjusts the display brightness.
- ⑧ **DISPLAY button (49)**
Displays information about the current input source.
- ⑨ **MUTING button (48)**
Mutes or unmutes the AV receiver.
- ⑩ **VOL [▲]/[▼] button (47)**
Adjusts the volume of the AV receiver regardless of the currently selected remote controller mode.
- ⑪ **RETURN button**
Returns to the previous display when changing settings.
- ⑫ **AUDIO button (69)**
Used to change audio settings.
When the Audio TV Out setting is set to On (page 81), this button is disabled.
- ⑬ **SLEEP button (48)**
Used with the Sleep function.

* SP A/B is not used in this AV receiver.

■ Controlling the tuner

To control the AV receiver's tuner, press the **[TUNER]** (or **[RECEIVER]**) **REMOTE MODE** button. You can select AM or FM by pressing the **[TUNER]** button repeatedly.

- ① **Arrow [▲]/[▼] buttons**
Used to tune into radio stations.
- ② **Number buttons (53)**
Used to select AM and FM radio stations directly.
- ③ **D.TUN button (53)**
Selects the Direct tuning mode.
- ④ **DISPLAY button (53)**
Displays information about the band, frequency, preset number, and so on.
- ⑤ **CH +/- button (54)**
Selects radio presets.

Note:

- An Onkyo cassette recorder connected via **RI** can also be controlled in Receiver mode (see page 95).

Installing the Batteries

- 1 To open the battery compartment, press the small lever and remove the cover.**

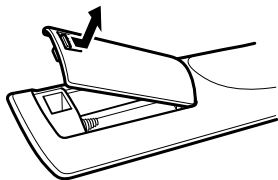

- 2 Insert the two supplied batteries (AA/R6) in accordance with the polarity diagram inside the battery compartment.**

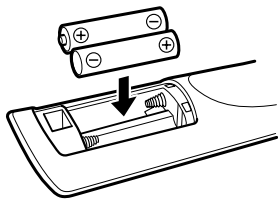

- 3 Replace the cover and push it shut.**

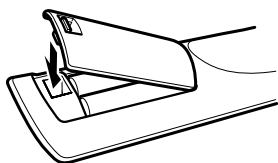

Notes:

- If the remote controller doesn't work reliably, try replacing the batteries.
- Don't mix new and old batteries or different types of batteries.
- If you intend not to use the remote controller for a long time, remove the batteries to prevent damage from leakage or corrosion.
- Expired batteries should be removed as soon as possible to prevent damage from leakage or corrosion.

Using the Remote Controller

When using the remote controller, point it toward the AV receiver's remote control sensor, as shown below.

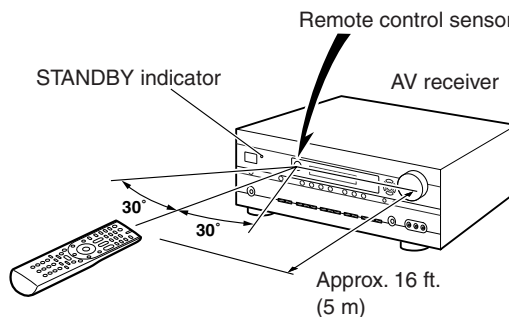

Notes:

- The remote controller may not work reliably if the AV receiver is subjected to bright light, such as direct sunlight or inverter-type fluorescent lights. Keep this in mind when installing.
- If another remote controller of the same type is used in the same room, or the AV receiver is installed close to equipment that uses infrared rays, the remote controller may not work reliably.
- Don't put anything on top of the remote controller, such as a book or magazine, because a button may be pressed continuously, thereby draining the batteries.
- The remote controller may not work reliably if the AV receiver is installed in a rack behind colored glass doors. Keep this in mind when installing.
- The remote controller will not work if there's an obstacle between it and the AV receiver's remote control sensor.

Connecting Your Speakers

Enjoying Home Theater

Thanks to the AV receiver's superb capabilities, you can enjoy surround sound with a real sense of movement in your own home—just like being in a movie theater or concert hall. You can enjoy DVDs featuring Dolby Digital or DTS. With analog or digital TV, you can enjoy Dolby Pro Logic IIx, DTS Neo:6, or Onkyo's original DSP listening modes.

Front left and right speakers

These output the main sound. Their role in a home theater is to provide a solid anchor for the sound image. They should be positioned facing the listener at about ear level, and equally spaced from the TV. Angle them inward slightly so as to create a triangle, with the listener at the apex.

Center speaker

This speaker enhances the front left and right speakers, making sound movements distinct and providing a full sound image. For movies it's used mainly for dialog.

Position it close to your TV (preferably on top) facing forward at about ear level, or at the same height as the front left and right speakers.

Subwoofer

The subwoofer handles the bass sounds of the LFE (Low-Frequency Effects) channel. The volume and quality of the bass output from your subwoofer will depend on its position, the shape of your listening room, and your listening position. In general, a good bass sound can be obtained by installing the subwoofer in a front corner, or at one-third the way along the front wall, as shown.

Tip: To find the best position for your subwoofer, while playing a movie or some music with good bass, experiment by placing your subwoofer at various positions within the room and choose the one that provides the most satisfying results.

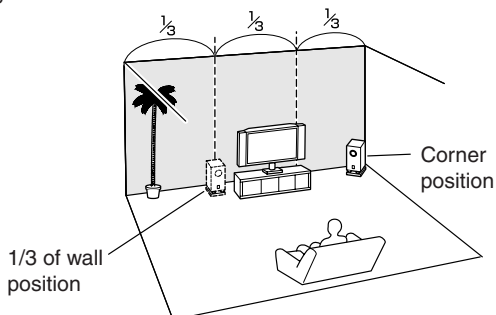

Surround left and right speakers

These speakers are used for precise sound positioning and to add realistic ambience.

Position them at the sides of the listener, or slightly behind, about 2–3 feet (60–100 cm) above ear level. Ideally they should be equally spaced from the listener.

Surround back left and right speakers

These speakers are necessary to enjoy Dolby Digital EX, DTS-ES Matrix, DTS-ES Discrete, etc. They enhance the realism of surround sound and improve sound localization behind the listener. Position them behind the listener about 2–3 feet (60–100 cm) above ear level.

Connecting Your Speakers—Continued

Speaker Configuration

For 7.1-channel surround-sound playback, you need seven speakers and a powered subwoofer.

The following table shows which channels you should use based on the number of speakers you have.

Number of speakers:	2	3	4	5	6	7
Front left	✓	✓	✓	✓	✓	✓
Front right	✓	✓	✓	✓	✓	✓
Center		✓		✓	✓	✓
Surround left			✓	✓	✓	✓
Surround right			✓	✓	✓	✓
Surround back*					✓	
Surround back left						✓
Surround back right						✓

* If you're using only one surround back speaker, connect it to the SURR BACK L terminals.

No matter how many speakers you use, a powered subwoofer is recommended for a powerful and solid bass.

To get the best from your surround-sound system, you must set the speaker settings. You can do this automatically (see page 38) or manually (see page 72).

Using Dipole Speakers

You can use dipole speakers for the surround left and right and surround back left and right speakers. Dipole speakers output the same sound in two directions.

Dipole speakers typically have an arrow printed on them to indicate how they should be positioned. The surround left and right dipole speakers should be positioned so that their arrows point toward your TV or screen, while the surround back left and right dipolar speakers should be positioned so that their arrows point toward each other, as shown.

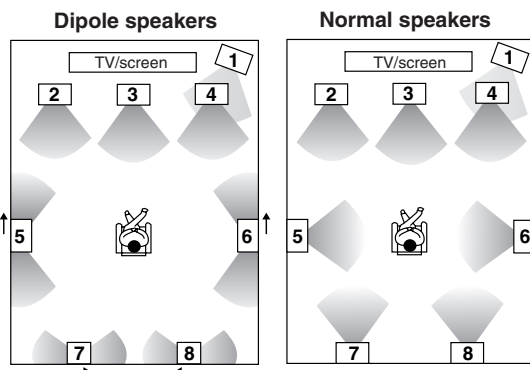

1. Subwoofer
2. Front left speaker
3. Center speaker
4. Front right speaker
5. Surround left speaker
6. Surround right speaker
7. Surround back left speaker
8. Surround back right speaker

Connecting a Powered Subwoofer

Using a suitable cable, connect the AV receiver's PRE OUT: SUBWOOFER to the input on your powered subwoofer. If your subwoofer is unpowered and you're using an external amplifier, connect the PRE OUT: SUBWOOFER to the amp's input.

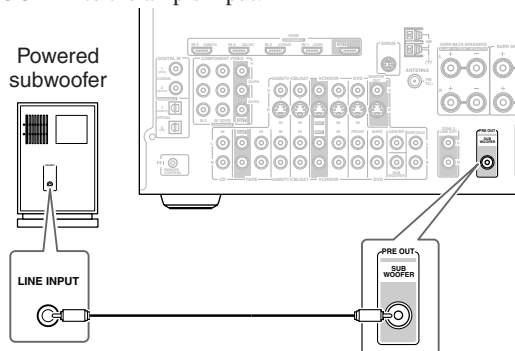

Attaching the Speaker Labels

The AV receiver's positive (+) speaker terminals are all red. (The negative (-) speaker terminals are all black.)

Speaker	Color
Front left	White
Front right	Red
Center	Green
Surround left	Blue
Surround right	Gray
Surround back left	Brown
Surround back right	Tan

The supplied speaker labels are color-coded and you should attach them to the positive (+) side of each speaker cable in accordance with the above table. All you need to do then is to match the color of each label to the corresponding speaker terminal.

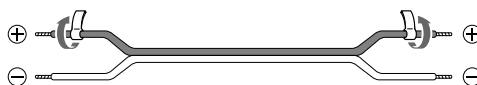

Connecting Your Speakers—Continued



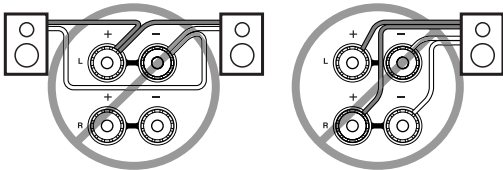
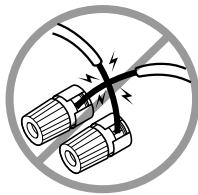

Speaker Connection Precautions

Read the following before connecting your speakers:

- **North American models:** You can connect speakers with an impedance of between 6 and 16 ohms. If you use speakers with a lower impedance, and use the amplifier at high volume levels for a long period of time, the built-in amp protection circuit may be activated.
- **Other models:** You can connect speakers with an impedance of between 4 and 16 ohms. If the impedance of any of the connected speakers is 4 ohms or more, but less than 6 ohms, be sure to set the minimum speaker impedance to “4 ohms” (see page 42). If you use speakers with a lower impedance, and use the amplifier at high volume levels for a long period of time, the built-in amp protection circuit may be activated.
- Disconnect the power cord from the wall outlet before making any connections.
- Read the instructions supplied with your speakers.
- Pay close attention to speaker wiring polarity. Connect positive (+) terminals to only positive (+) terminals, and negative (–) terminals to only negative (–) terminals. If you get them the wrong way around, the sound will be out of phase and will sound unnatural.
- Unnecessarily long or very thin speaker cables may affect the sound quality and should be avoided.
- Be careful not to short the positive and negative wires. Doing so may damage the AV receiver.
- Don’t connect more than one cable to each speaker terminal. Doing so may damage the AV receiver.
- Don’t connect a speaker to several terminals.

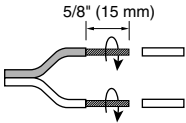

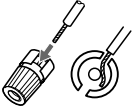
Connecting the Speaker Cables

- 1 **Strip about 5/8" (15 mm) of insulation from the ends of the speaker cables, and twist the bare wires tightly, as shown.** 
- 2 **Unscrew the terminal.** 
- 3 **Fully insert the bare wire.** 
- 4 **Screw the terminal tight.** 

The following illustration shows which speaker should be connected to each pair of terminals.

If you’re using only one surround back speaker, connect it to the left (L) SURR BACK SPEAKERS terminals.

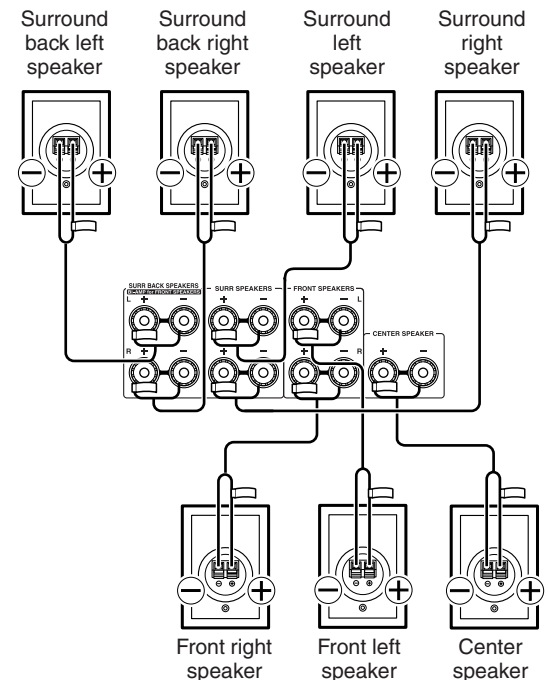

Bi-amping Front Speakers

The FRONT L/R and SURR BACK L/R terminal posts can be used with front speakers and surround back speakers respectively, or bi-amped to provide separate tweeter and woofer feeds for front speakers, providing improved bass and treble performance.

- When bi-amping is used, the AV receiver is able to drive up to 5.1 speakers in the main room.
- For bi-amping, the FRONT L/R terminal posts connect to the front speakers' tweeter terminals. And the SURR BACK L/R terminal posts connect to the front speakers' woofer terminals.
- Once you've completed the bi-amping connections shown below and turned on the AV receiver, you must set the Speaker Type setting to Bi-Amp to enable bi-amping (see page 42).

Important:

- **When making the bi-amping connections, be sure to remove the jumper bars that link the speakers' tweeter (high) and woofer (low) terminals.**
- Bi-amping can only be used with speakers that support bi-amping. Refer to your speaker manual.

Bi-amping Speaker Hookup

- 1 Connect the AV receiver's FRONT R positive (+) terminal to the right speaker's positive (+) tweeter (high) terminal. And connect the AV receiver's FRONT R negative (-) terminal to the right speaker's negative (-) tweeter (high) terminal.
- 2 Connect the AV receiver's SURR BACK R positive (+) terminal to the right speaker's positive (+) woofer (low) terminal. And connect the AV receiver's SURR BACK R negative (-) terminal to the right speaker's negative (-) woofer (low) terminal.
- 3 Connect the AV receiver's FRONT L positive (+) terminal to the left speaker's positive (+) tweeter (high) terminal. And connect the AV receiver's FRONT L negative (-) terminal to the left speaker's negative (-) tweeter (high) terminal.
- 4 Connect the AV receiver's SURR BACK L positive (+) terminal to the left speaker's positive (+) woofer (low) terminal. And connect the AV receiver's SURR BACK L negative (-) terminal to the left speaker's negative (-) woofer (low) terminal.

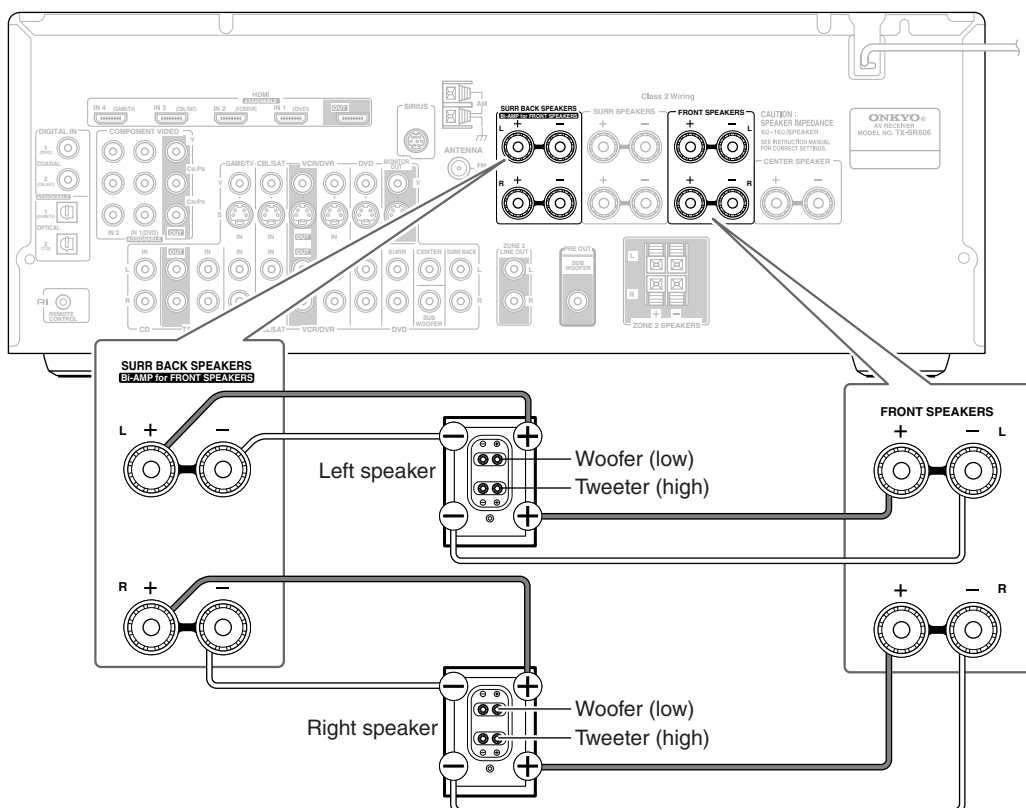

Connecting Antennas

This section explains how to connect the supplied indoor FM antenna and AM loop antenna, and how to connect commercially available outdoor FM and AM antennas.

The AV receiver won't pick up any radio signals without any antenna connected, so you must connect the antenna to use the tuner.

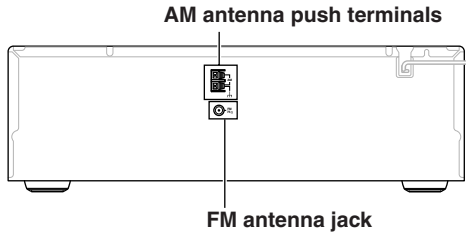

Connecting the Indoor FM Antenna

The supplied indoor FM antenna is for indoor use only.

1 Attach the FM antenna, as shown.

■ American Model

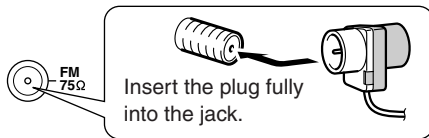

■ Other Models

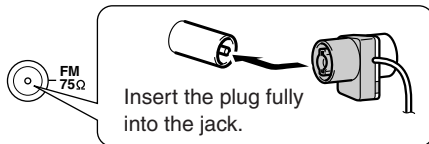

Once your AV receiver is ready for use, you'll need to tune into an FM radio station and adjust the position of the FM antenna to achieve the best possible reception.

2 Use thumbtacks or something similar to fix the FM antenna into position.

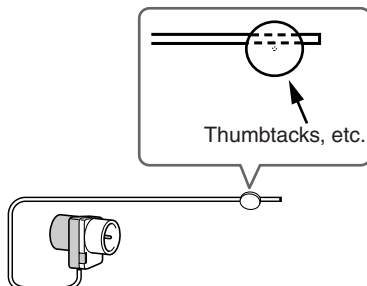

Caution: Be careful that you don't injure yourself when using thumbtacks.

If you cannot achieve good reception with the supplied indoor FM antenna, try a commercially available outdoor FM antenna instead (see page 19).

Connecting the AM Loop Antenna

The supplied indoor AM loop antenna is for indoor use only.

1 Assemble the AM loop antenna, inserting the tabs into the base, as shown.

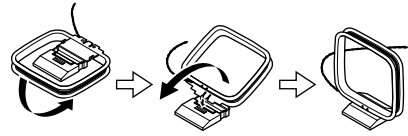

2 Connect both wires of the AM loop antenna to the AM push terminals, as shown.

(The antenna's wires are not polarity sensitive, so they can be connected either way around).

Make sure that the wires are attached securely and that the push terminals are gripping the bare wires, not the insulation.

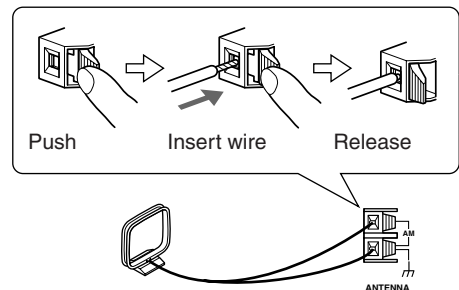

Once your AV receiver is ready for use, you'll need to tune into an AM radio station and adjust the position of the AM antenna to achieve the best possible reception.

Keep the antenna as far away as possible from your AV receiver, TV, speaker cables, and power cords.

If you cannot achieve good reception with the supplied indoor AM loop antenna, try using it with a commercially available outdoor AM antenna (see page 19).

Connecting an Outdoor FM Antenna

If you cannot achieve good reception with the supplied indoor FM antenna, try a commercially available outdoor FM antenna instead.

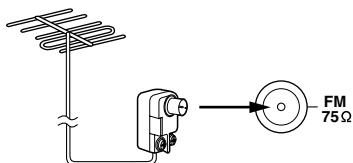

Notes:

- Outdoor FM antennas work best outside, but usable results can sometimes be obtained when installed in an attic or loft.
- For best results, install the outdoor FM antenna well away from tall buildings, preferably with a clear line of sight to your local FM transmitter.
- Outdoor antenna should be located away from possible noise sources, such as neon signs, busy roads, etc.
- For safety reasons, outdoor antenna should be situated well away from power lines and other high-voltage equipment.
- Outdoor antenna must be grounded in accordance with local regulations to prevent electrical shock hazards.

■ Using a TV/FM Antenna Splitter

It's best not to use the same antenna for both FM and TV reception, as this can cause interference problems. If circumstances demand it, use a TV/FM antenna splitter, as shown.

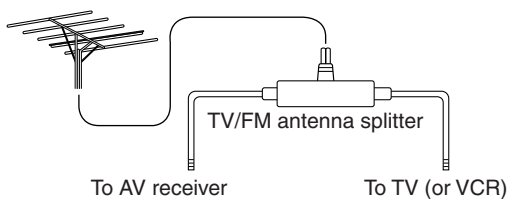

Connecting an Outdoor AM Antenna

If good reception cannot be achieved using the supplied AM loop antenna, an outdoor AM antenna can be used in addition to the loop antenna, as shown.

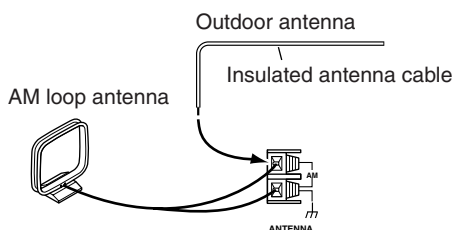

Outdoor AM antennas work best when installed horizontally outside, but good results can sometimes be obtained indoors by mounting horizontally above a window. Note that the AM loop antenna should be left connected.

Outdoor antenna must be grounded in accordance with local regulations to prevent electrical shock hazards.

Connecting Your Components

About AV Connections

- Before making any AV connections, read the manuals supplied with your other AV components.
- Don't connect the power cord until you've completed and double-checked all AV connections.

Optical Digital Jacks

The AV receiver's optical digital jacks have shutter-type covers that open when an optical plug is inserted and close when it's removed. Push plugs in all the way.

Caution: To prevent shutter damage, hold the optical plug straight when inserting and removing.

AV Connection Color Coding

RCA-type AV connections are usually color coded: red, white, and yellow. Use red plugs to connect right-channel audio inputs and outputs (typically labeled "R"). Use white plugs to connect left-channel audio inputs and outputs (typically labeled "L"). And use yellow plugs to connect composite video inputs and outputs.

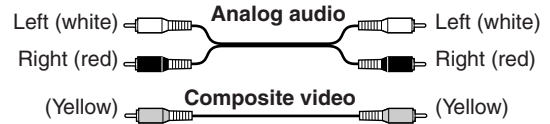

- Push plugs in all the way to make good connections (loose connections can cause noise or malfunctions).
- To prevent interference, keep audio and video cables away from power cords and speaker cables.

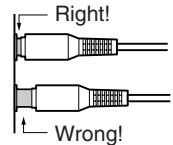

AV Cables and Jacks

Video

	Cable	Jack	Description
HDMI			HDMI connections can carry uncompressed standard- or high-definition digital video and audio and offer the best picture and sound quality.
Component video cable			Component video separates the luminance (Y) and color difference signals (PR, PB), providing the best picture quality. (Some TV manufacturers label their component video jacks slightly differently.)
S-Video cable			S-Video separates the luminance and color signals and provides better picture quality than composite video.
Composite video cable			Composite video is commonly used on TVs, VCRs, and other video equipment.

Audio

Optical digital audio cable			This offers the best sound quality and allows you to enjoy Dolby Digital and DTS. The audio quality is the same as for coaxial.
Coaxial digital audio cable			This offers the best sound quality and allows you to enjoy Dolby Digital and DTS. The audio quality is the same as for optical.
Analog audio cable (RCA)			This cable carries analog audio. It's the most common connection format for analog audio and can be found on virtually all AV components.
Multichannel analog audio cable (RCA)			This cable carries multichannel analog audio and is typically used to connect DVD players with a 7.1-channel analog audio output. Several standard analog audio cables can be used instead of a multichannel cable.

Note: The AV receiver does not support SCART connections.

Connecting Audio and Video Signals to the AV Receiver

By connecting both the audio and video outputs of your DVD player and other AV components to the AV receiver, you can switch the audio and video signals simultaneously simply by changing the input source on the AV receiver.

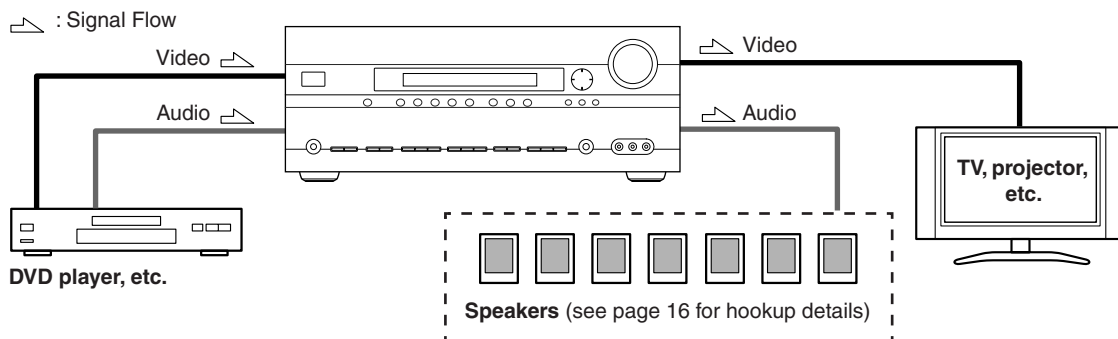

Which Connections Should I Use?

The AV receiver supports several connection formats for compatibility with a wide range of AV equipment. The format you choose will depend on the formats supported by your other components. Use the following sections as a guide.

For video components, you must make an audio connection and a video connection.

Audio Connection Formats

Audio equipment can be connected to the AV receiver by using any of the following audio connection formats: analog, optical, coaxial, analog multichannel, or HDMI.

When you connect audio equipment to an HDMI, OPTICAL, or COAXIAL input, you must assign that input to an input selector (see pages 44).

When choosing a connection format, bear in mind that the AV receiver does not convert digital input signals for analog line outputs and vice versa. For example, audio signals connected to an optical or coaxial digital input are not output by the analog TAPE OUT.

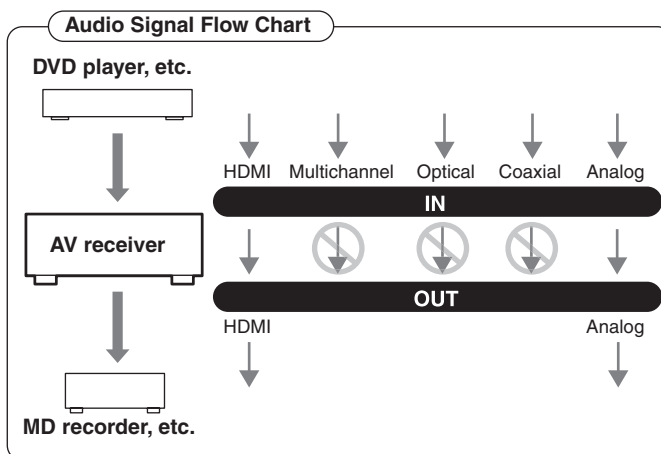

If signals are present at more than one input, the inputs will be selected automatically in the following order of priority: HDMI, digital, analog (including multichannel). You can specify which audio inputs the AV receiver checks for the presence of a signal in the “Automatic Audio Input Selection Setup” on page 46.

Video Connection Formats

Video equipment can be connected to the AV receiver by using any one of the following video connection formats: composite video, S-Video, component video, or HDMI, the latter offering the best picture quality.

Video input signals flow through the AV receiver as shown, with composite video, S-Video, and component video sources all being upconverted for the HDMI output.

The composite video, S-Video, and component video outputs pass through their respective input signals as they are.

When you connect audio equipment to an HDMI or COMPONENT input, you must assign that input to an input selector (see pages 43 and 44).

If signals are present at more than one input, the inputs will be selected automatically in the following order of priority: HDMI, component video, S-Video, composite video. However, for component video only, regardless of whether a component video signal is actually present, if a component video input is assigned to the input selector, that component video input will be selected. And if no component video input is assigned to the input selector, this will be interpreted as no component video signal being present.

In the Signal Selection Example shown on the right, video signals are present at both the S-Video and composite video inputs, however, the S-Video signal is automatically selected as the source and video is output by the S-Video and HDMI outputs.

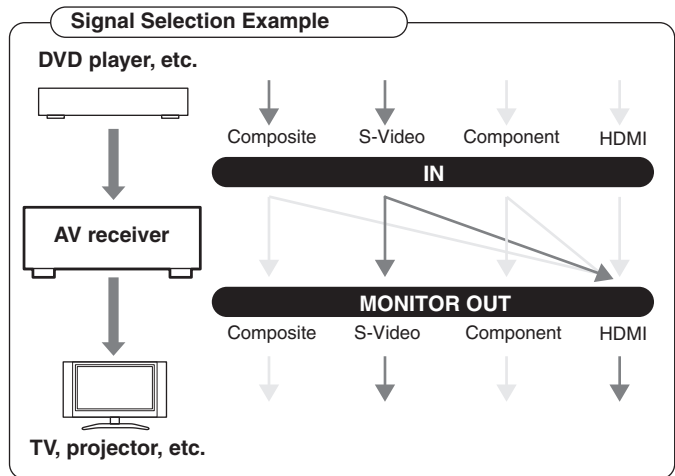
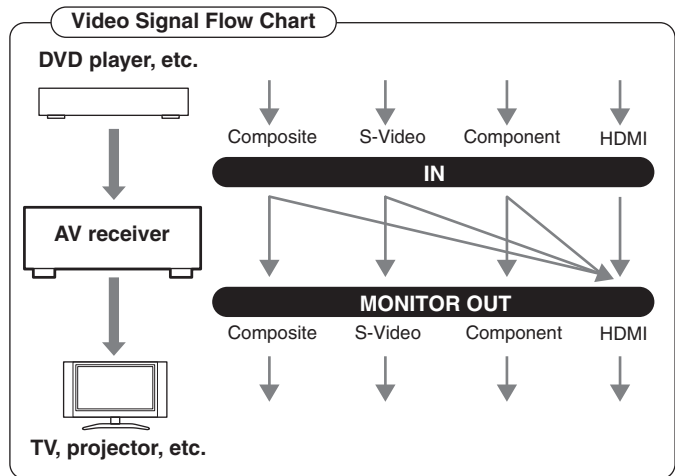

The onscreen setup menus appear only on a TV that is connected to the HDMI OUT. If your TV is connected to the composite video or S-Video MONITOR OUT, or the COMPONENT VIDEO OUT, use the TX-SR606's display when changing settings.

Connecting Your Components—Continued

Connecting a TV or Projector

Step 1: Video Connection

Choose a video connection that matches your TV (**A**, **B**, or **C**), and then make the connection.

Step 2: Audio Connection

Choose an audio connection that matches your TV (**a**, **b**, or **c**), and then make the connection.

The onscreen setup menus appear only on a TV that is connected to the HDMI OUT. If your TV is connected to the composite video or S-Video MONITOR OUT, or the COMPONENT VIDEO OUT, use the TX-SR606's display when changing settings.

- With connection **a**, you can listen to and record audio from your TV or listen in Zone 2.
- To enjoy Dolby Digital and DTS, use connection **b** or **c**. (To record or listen in Zone 2 as well, use **a** and **b**, or **a** and **c**.)

Connection	AV receiver	Signal flow	TV	Picture quality
A	COMPONENT VIDEO OUT	⇒	Component video input	Best
B	MONITOR OUT S	⇒	S-Video input	Better
C	MONITOR OUT V	⇒	Composite video input	Standard
a	GAME/TV IN L/R	⇐	Analog audio L/R output	
b	DIGITAL IN COAXIAL 2	⇐	Digital coaxial output	
c	DIGITAL IN OPTICAL 1	⇐	Digital optical output	

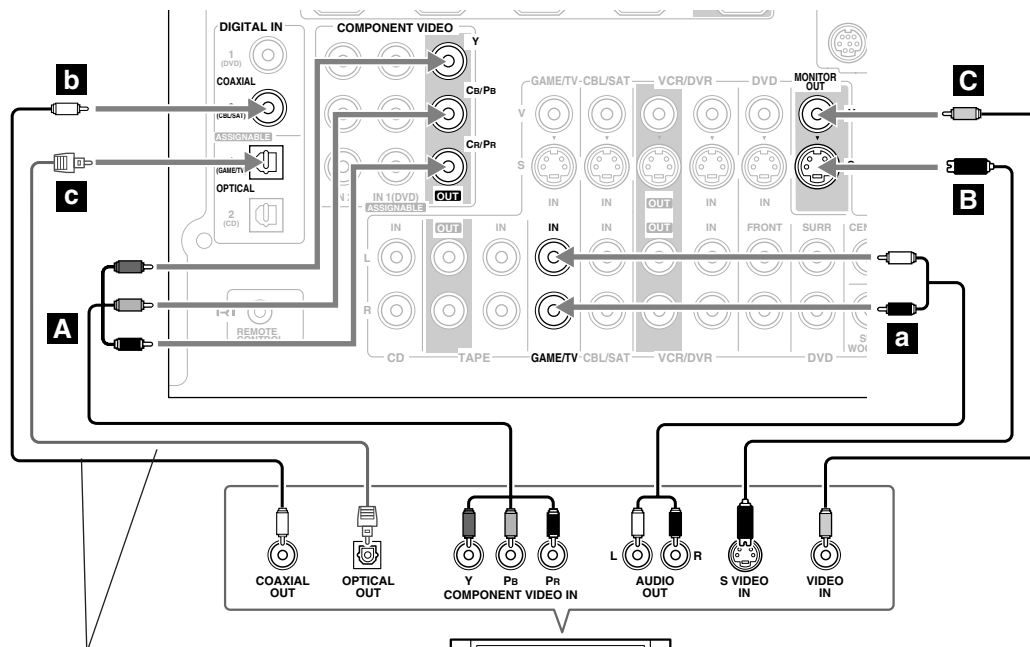

Connect one or the other Connection **C** must be assigned (see page 44)



If your TV has no audio outputs, connect an audio output from your VCR or cable or satellite receiver to the AV receiver and use its tuner to listen to TV programs through the AV receiver (see pages 26 and 28).

Connecting a DVD player

Step 1: Video Connection

Choose a video connection that matches your DVD player (**A**, **B**, or **C**), and then make the connection. You must connect the AV receiver to your TV with the same type of connection.

Step 2: Audio Connection

Choose an audio connection that matches your DVD player (**a**, **b**, or **c**), and then make the connection.

- With connection **a**, you can listen to and record audio from a DVD or listen in Zone 2.
- To enjoy Dolby Digital and DTS, use connection **b** or **c**. (To record or listen in Zone 2 as well, use **a** and **b**, or **a** and **c**.)
- If your DVD player has main left and right outputs and multichannel left and right outputs, be sure to use the main left and right outputs for connection **a**.

Connection	AV receiver	Signal flow	DVD player	Picture quality
A	COMPONENT VIDEO IN 1	←	Component video output	Best
B	DVD IN S	←	S-Video output	Better
C	DVD IN V	←	Composite video output	Standard
a	DVD IN FRONT L/R	←	Analog audio L/R output	
b	DIGITAL IN COAXIAL 1	←	Digital coaxial output	
c	DIGITAL IN OPTICAL 1	←	Digital optical output	

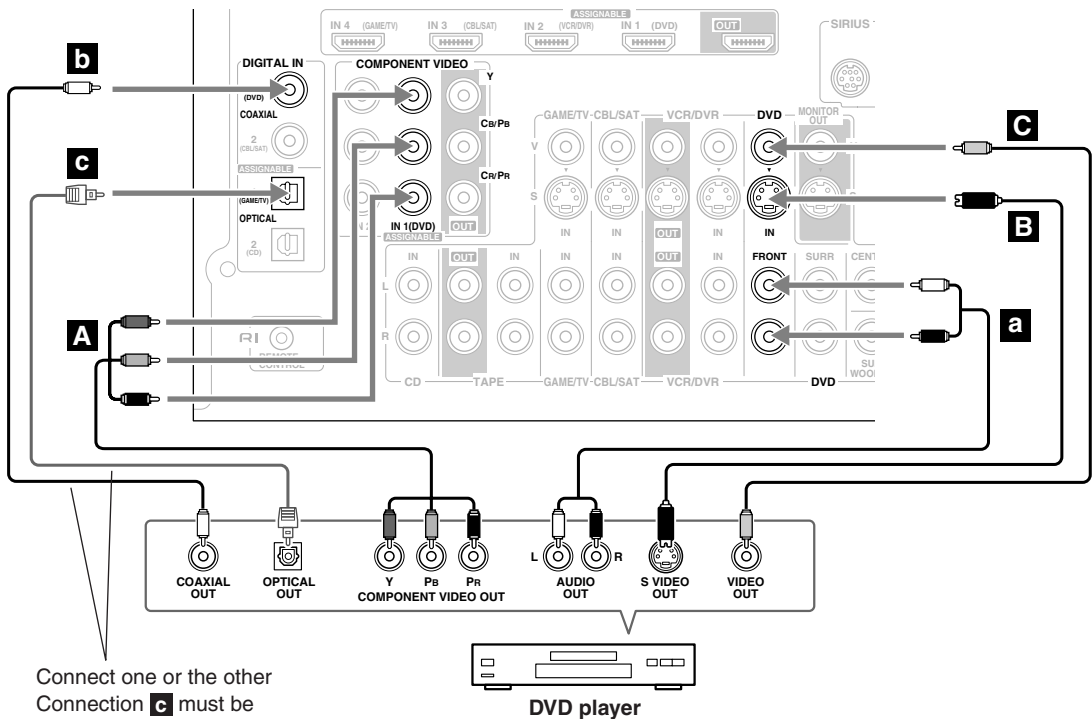

To connect a DVD player or DVD-Audio/SACD-capable player with a multichannel analog audio output, see page 25.

Connecting Your Components—Continued

Hooking Up the Multichannel Input

If your DVD player supports multichannel audio formats such as DVD-Audio and SACD, and it has a multichannel analog audio output, you can connect it to the AV receiver's multichannel input.

Use a multichannel analog audio cable, or several normal audio cables, to connect the AV receiver's DVD IN FRONT L/R, CENTER, SURR L/R, SURR BACK L/R, and SUBWOOFER jacks to the 7.1-channel analog audio output on your DVD player. If your DVD player has a 5.1-channel analog audio output, don't connect anything to the AV receiver's SURR BACK L/R jacks.

To select the multichannel input, see "Basic AV Receiver Operation" on page 47. To adjust the subwoofer sensitivity for the multichannel input, see "Hardware Setup" on page 79.

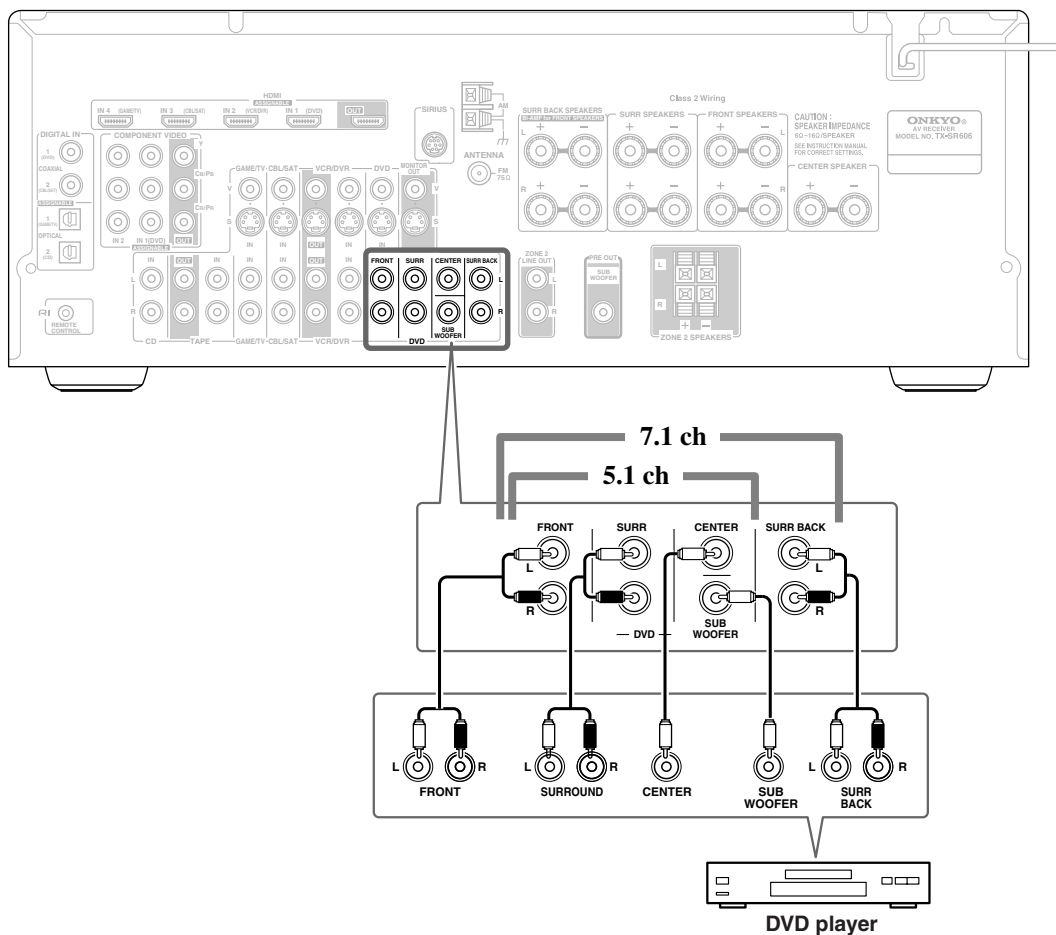

Connecting a VCR or DVR for Playback



With this hookup, you can use the tuner in your VCR or DVR to listen to your favorite TV programs via the AV receiver, which is useful if your TV has no audio outputs.

Step 1: Video Connection

Choose a video connection that matches your VCR or DVR (**A**, **B**, or **C**), and then make the connection. You must connect the AV receiver to your TV with the same type of connection.

Step 2: Audio Connection

Choose an audio connection that matches your VCR or DVR (**a**, **b**, or **c**), and then make the connection.

- With connection **a**, you can listen to the VCR or DVR in Zone 2.
- To enjoy Dolby Digital and DTS, use connection **b** or **c**. (To listen in Zone 2 as well, use **a** and **b**, or **a** and **c**.)

Connection	AV receiver	Signal flow	VCR or DVR	Picture quality
A	COMPONENT VIDEO IN 2	←	Component video output	Best
B	VCR/DVR IN S	←	S-Video output	Better
C	VCR/DVR IN V	←	Composite video output	Standard
a	VCR/DVR IN L/R	←	Analog audio L/R output	
b	DIGITAL IN COAXIAL 2	←	Digital coaxial output	
c	DIGITAL IN OPTICAL 1	←	Digital optical output	

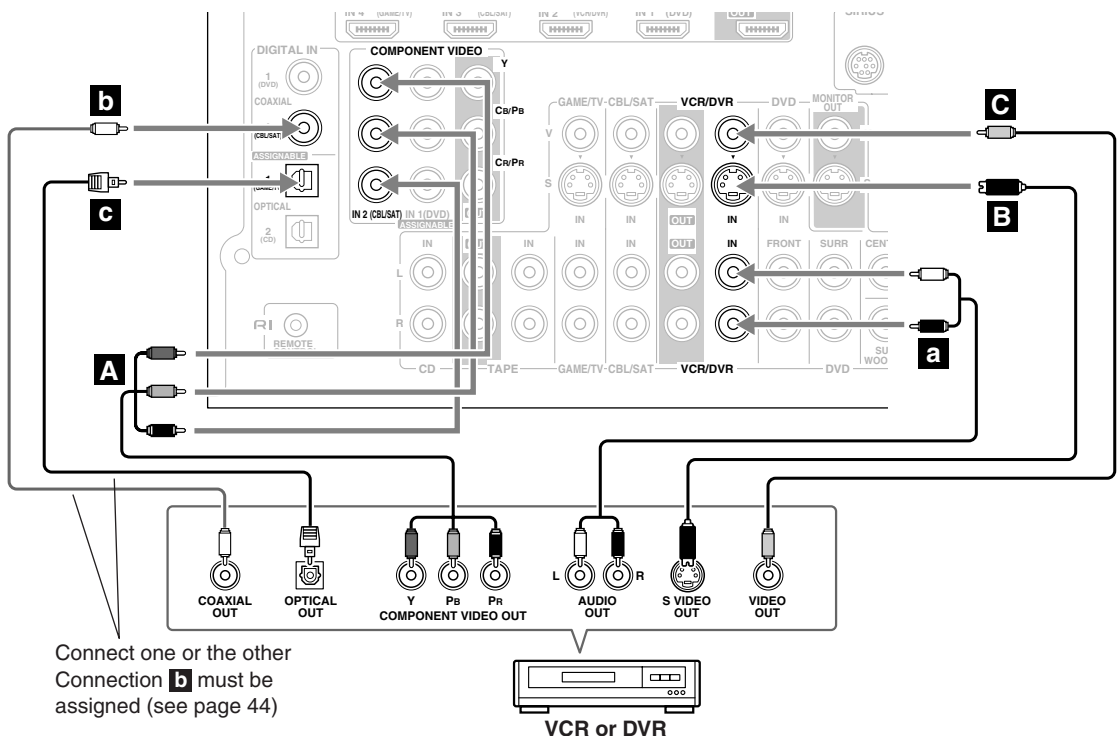

Connecting Your Components—Continued

Connecting a VCR or DVR for Recording

Step 1: Video Connection

Choose a video connection that matches your VCR or DVR (**A** or **B**), and then make the connection. The video source to be recorded must be connected to the AV receiver via the same type of connection.

Step 2: Audio Connection

Make the audio connection **a**.

Connection	AV receiver	Signal flow	VCR or DVD recorder	Picture quality
A	VCR/DVR OUT S	⇒	S-Video input	Better
B	VCR/DVR OUT V	⇒	Composite video input	Standard
a	VCR/DVR OUT L/R	⇒	Audio L/R input	

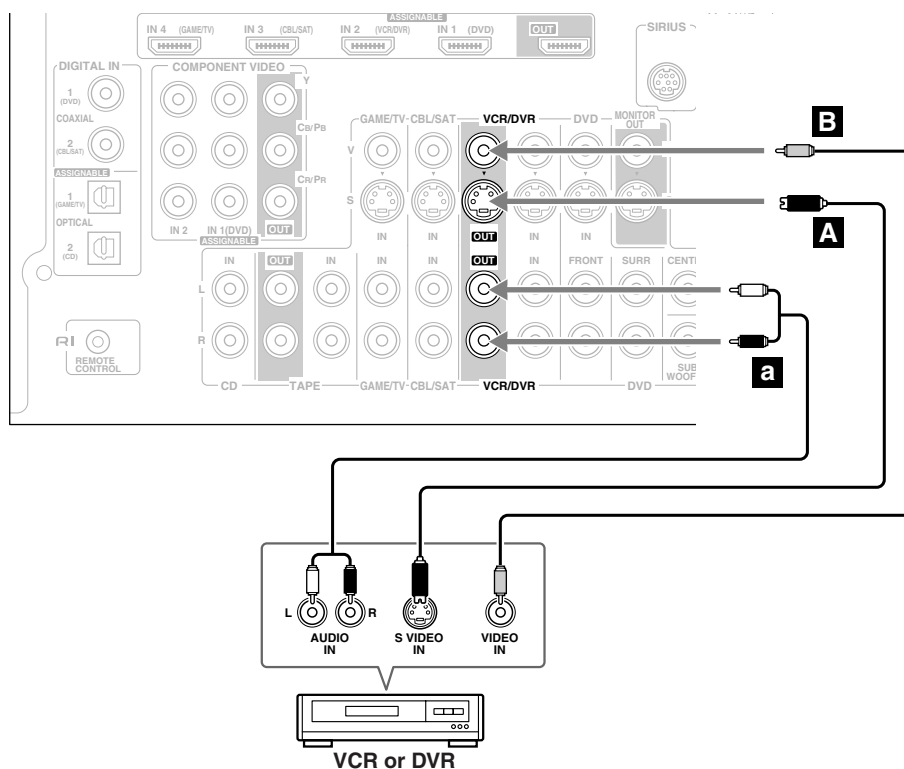

Notes:

- The AV receiver must be turned on for recording. Recording is not possible while it's on Standby.
- If you want to record directly from your TV or another video source without going through the AV receiver, connect the audio and video outputs from your TV or other video component directly to the recording VCR/DVR's audio and video inputs. See the manuals supplied with your TV or VCR/DVR for details.
- Video signals connected to composite video inputs can only be recorded via the VCR/DVR OUT V jack. So if your source TV or VCR is connected to a composite video input, the recording VCR/DVR must be connected to the VCR/DVR OUT V jack. Likewise, video signals connected to S-Video inputs can only be recorded via the VCR/DVR OUT S jack. So if your source TV or VCR is connected to an S-Video input, the recording VCR/DVR must be connected to the VCR/DVR OUT S jack.

Connecting a Satellite, Cable, Terrestrial Set-top box, or Other Video Source



With this hookup, you can use your satellite or cable receiver to listen to your favorite TV programs via the AV receiver, which is useful if your TV has no audio outputs.

Step 1: Video Connection

Choose a video connection that matches the video source (**A**, **B**, or **C**), and then make the connection. You must connect the AV receiver to your TV with the same type of connection.

Step 2: Audio Connection

Choose an audio connection that matches the video source (**a**, **b**, or **c**), and then make the connection.

- With connection **a**, you can listen to and record audio from the video source or listen in Zone 2.
- To enjoy Dolby Digital and DTS, use connection **b** or **c**. (To record or listen in Zone 2 as well, use **a** and **b**, or **a** and **c**.)

Connection	AV receiver	Signal flow	Video source	Picture quality
A	COMPONENT VIDEO IN 2	←	Component video output	Best
B	CBL/SAT IN S	←	S-Video output	Better
C	CBL/SAT IN V	←	Composite video output	Standard
a	CBL/SAT IN L/R	←	Analog audio L/R output	
b	DIGITAL IN COAXIAL 2	←	Digital coaxial output	
c	DIGITAL IN OPTICAL 1	←	Digital optical output	

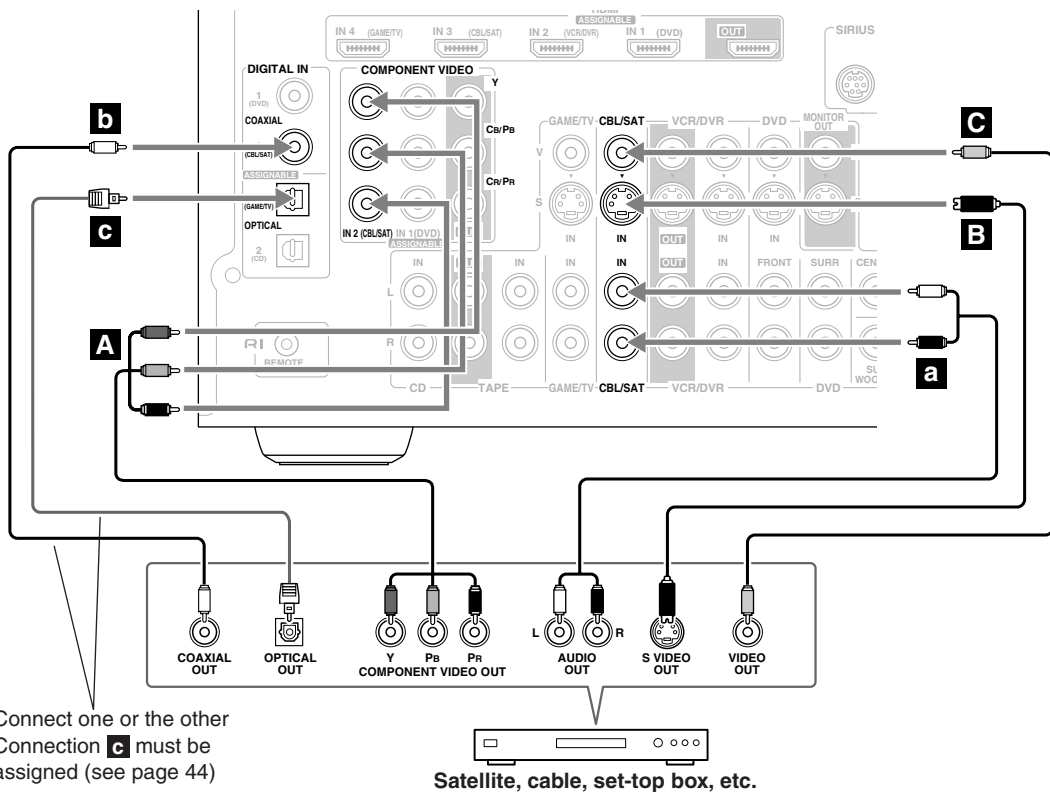

Connecting Your Components—Continued

Connecting a Game Console

Step 1: Video Connection

Choose a video connection that matches your game console (**A**, **B**, or **C**), and then make the connection. If you use connection **A**, you must connect the AV receiver to your TV with the same type of connection.

Step 2: Audio Connection

Choose an audio connection that matches your DVD player (**a**, **b**, or **c**), and then make the connection.

- With connection **a**, you can listen to and record audio from your game console or listen in Zone 2.
- To enjoy Dolby Digital and DTS, use connection **b**. (To record or listen in Zone 2 as well, use **a** and **b**.)

Connection	AV receiver	Signal flow	Game console	Picture quality
A	COMPONENT VIDEO IN 2	←	Component video output	Best
B	GAME/TV IN S	←	S-Video output	Better
C	GAME/TV IN V	←	Composite video output	Standard
a	GAME/TV IN L/R	←	Analog audio L/R output	
b	DIGITAL OPTICAL IN 1	←	Digital optical output	

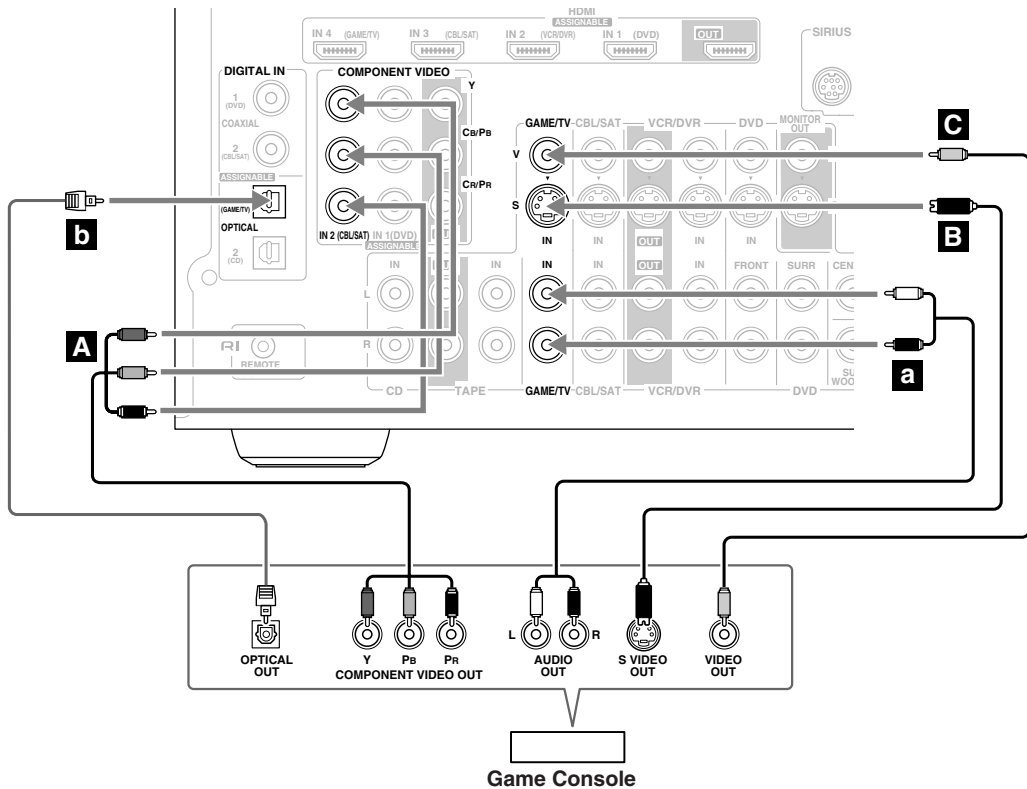

Connecting Components with HDMI

About HDMI

Designed to meet the increased demands of digital TV, HDMI (High Definition Multimedia Interface) is a new digital interface standard for connecting TVs, projectors, DVD players, set-top boxes, and other video components. Until now, several separate video and audio cables have been required to connect AV components. With HDMI, a single cable can carry control signals, digital video, and up to eight channels of digital audio (2-channel PCM, multichannel digital audio, or multichannel PCM).

The HDMI video stream (i.e., video signal) is compatible with DVI (Digital Visual Interface),^{*1} so TVs and displays with a DVI input can be connected by using an HDMI-to-DVI adapter cable. (This may not work with some TVs and displays, resulting in no picture.)

The AV receiver uses HDCP (High-bandwidth Digital Content Protection), so only HDCP-compatible components will display a picture.

The AV receiver's HDMI interface is based on the following standard:

Repeater System, Deep Color, Lip Sync, DTS-HD Master Audio, DTS-HD High Resolution Audio, Dolby TrueHD, Dolby Digital Plus, SA-CD and Multichannel PCM

Supported Audio Formats

- 2-channel linear PCM (16/20/24 bit/32–192kHz)
- Multichannel linear PCM (7.1 ch, 32–192kHz)
- Bitstream (Dolby Digital, Dolby Digital Plus, DTS, DTS-HD Master Audio, DTS-HD High Resolution Audio, Dolby TrueHD, DSD)

Your DVD player must be able to output these formats from its HDMI OUT.

About Copyright Protection

The AV receiver supports HDCP (High-bandwidth Digital Content Protection),^{*2} a copy-protection system for digital video signals. Other devices connected to the AV receiver via HDMI must also support HDCP.

Use a commercially available HDMI cable (supplied with some components) to connect the AV receiver's HDMI OUT to the HDMI input on your TV or projector.

*1 DVI (Digital Visual Interface): The digital display interface standard set by the DDWG^{*3} in 1999.

*2 HDCP (High-bandwidth Digital Content Protection): The video encryption technology developed by Intel for HDMI/DVI. It's designed to protect video content and requires a HDCP-compatible device to display the encrypted video.

*3 DDWG (Digital Display Working Group): Led by Intel, Compaq, Fujitsu, Hewlett Packard, IBM, NEC, and Silicon Image, this open industry group's objective is to address the industry's requirements for a digital connectivity specification for high-performance PCs and digital displays.

Making HDMI Connections

Step 1: Use HDMI cables to connect the AV receiver's HDMI jacks to your HDMI-compatible DVD player, TV, projector, and so on.

Step 2: Assign each HDMI IN to an input selector in the HDMI Input Setup (see page 43).

■ Video Signals

Digital video signals received by the HDMI IN jacks are normally output by the HDMI OUT for display on your TV. Composite video, S-Video, and component video sources can be upconverted for the HDMI output. See “Video Connection Formats” on page 22 for more information.

■ Audio Signals

Digital audio signals received by the HDMI IN jacks are output by the speakers and headphones connected to the AV receiver. Normally, they are not output by the HDMI OUT, unless the Audio TV Out setting is set to On (see page 81).



To listen to audio received by the HDMI IN jacks through your TV's speakers, set the Audio TV Out setting to On (see page 81), and set your DVD player's HDMI audio output setting to PCM.

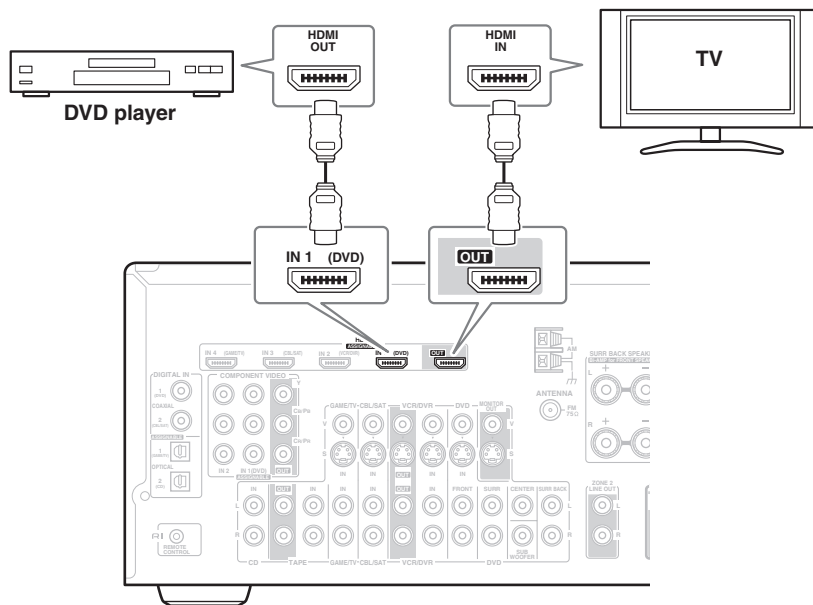

Notes:

- The HDMI video stream is compatible with DVI (Digital Visual Interface), so TVs and displays with a DVI input can be connected by using an HDMI-to-DVI adapter cable. (Note that DVI connections only carry video, so you'll need to make a separate connection for audio.) However, reliable operation with such an adapter is not guaranteed. In addition, video signals from a PC are not supported.
- When listening to an HDMI component through the AV receiver, set the HDMI component so that its video can be seen on the TV screen (on the TV, select the input of the HDMI component connected to the AV receiver). If the TV power is off or the TV is set to another input source, this may result in no sound from the AV receiver or the sound may be cut off.
- The HDMI audio signal (sampling rate, bit length, etc.) may be restricted by the connected source component. If the picture is poor or there's no sound from a component connected via HDMI, check its setup. Refer to the connected component's instruction manual for details.

Connecting a Camcorder or Other Device

Step 1: Make the video connection **A**.

Step 2: Make the audio connection **a**.

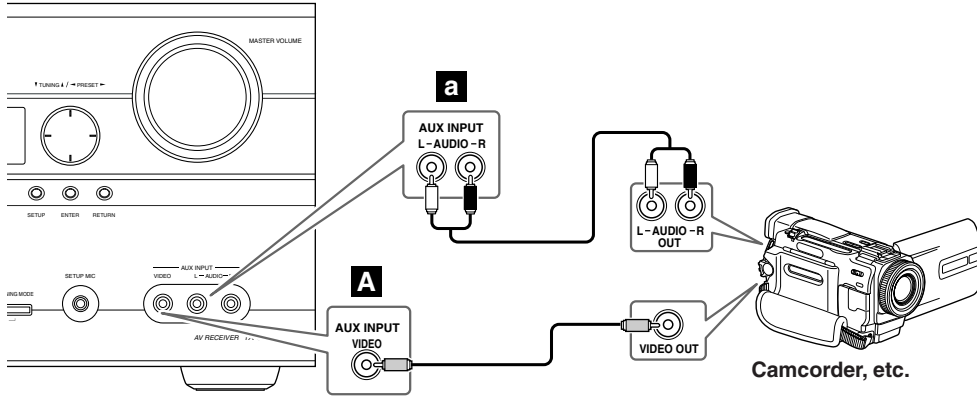

Connection	AV receiver	Signal flow	Camcorder or console
A	AUX INPUT VIDEO	←	Composite video output
a	AUX INPUT L-AUDIO-R	←	Analog audio L/R output

Connecting Your Components—Continued

Connecting a CD Player or Turntable

■ CD Player or Turntable (MM) with Built-in Phono Preamp

Step 1:

Choose a connection that matches your CD player (**a**, **b**, or **c**). Use connection **a** for a turntable with a built-in phono preamp.

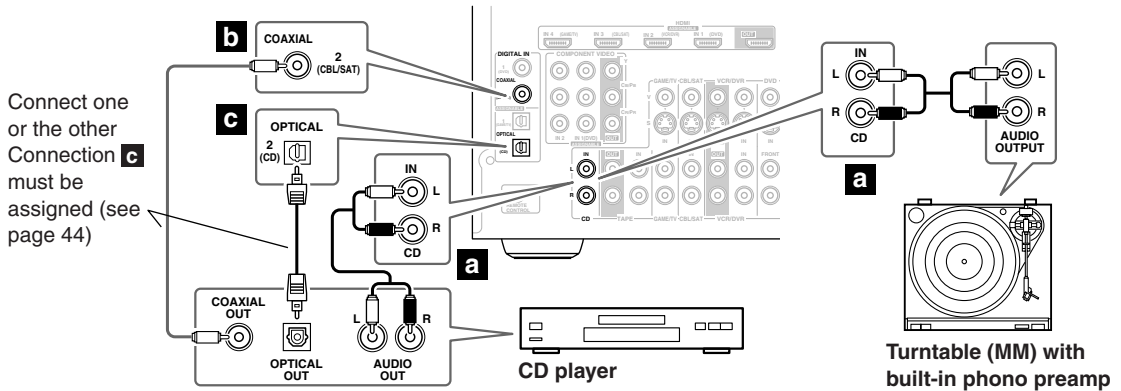

- With connection **a**, you can listen to and record audio from the CD player or listen in Zone 2.
- To connect the CD player digitally, use connection **b** or **c**. (To record or listen in Zone 2 as well, use **a** and **b**, or **a** and **c**.)

Connection	AV receiver	Signal flow	CD or turntable
a	CD IN L/R	←	Analog audio L/R output
b	DIGITAL IN COAXIAL 2	←	Digital coaxial output
c	DIGITAL IN OPTICAL 2	←	Digital optical output

■ Turntable (MM) with no Phono Preamp Built-in

A phono preamp is necessary to connect a turntable that doesn't have a phono preamp built-in.

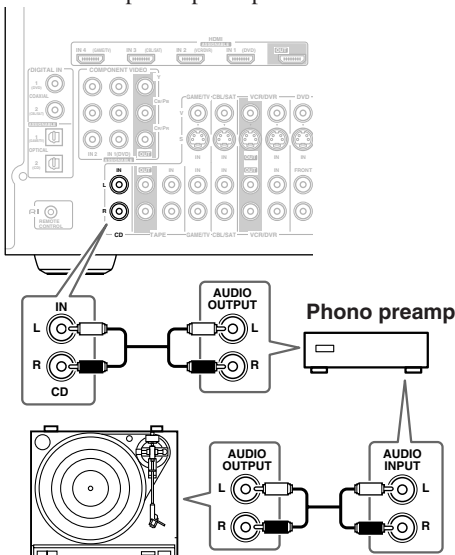

■ Turntable with an MC (Moving Coil) Cartridge

An MC head amp and phono preamp are necessary to connect a turntable with an MC (Moving Coil) cartridge.

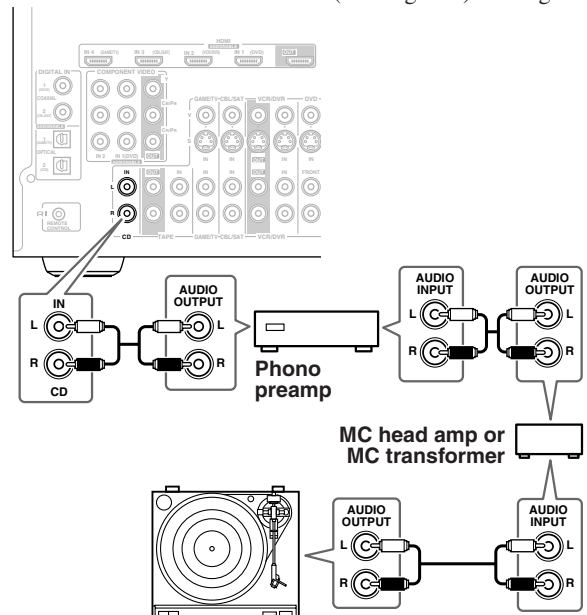

Connecting a Cassette, CDR, MiniDisc, or DAT Recorder

Step 1:

Choose a connection that matches your recorder (**a**, **b**, or **c**), and then make the connection.

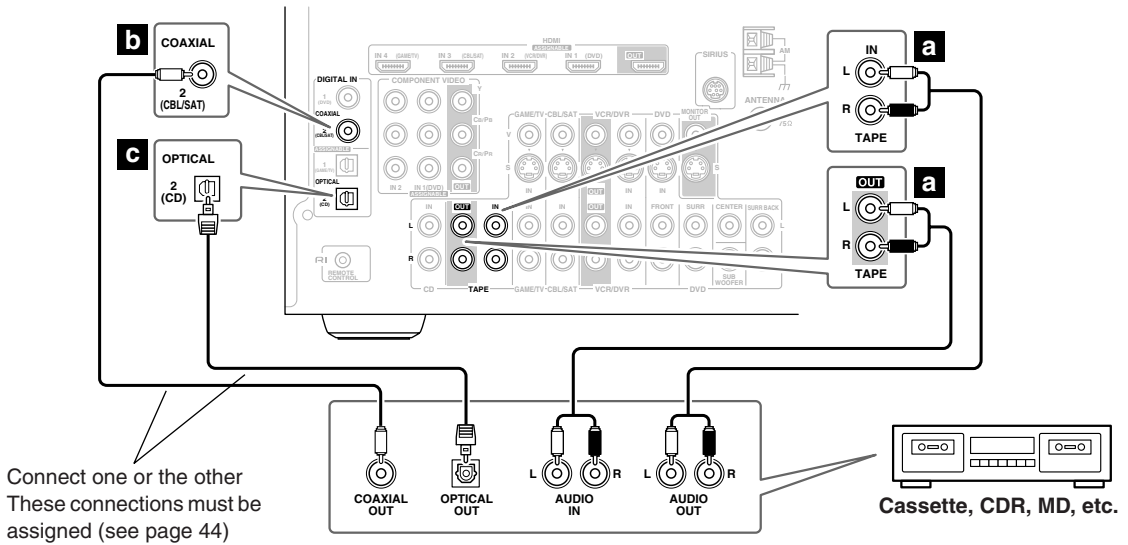

- With connection **a**, you can play and record or listen in Zone 2.
- To connect the recorder digitally for playback, use connections **a** and **b**, or **a** and **c**.

Connection	AV receiver	Signal flow	Cassette, CDR, MD, or DAT recorder
a	TAPE IN L/R TAPE OUT L/R	← ⇒	Analog audio L/R output Analog audio L/R input
b	DIGITAL IN COAXIAL 2	←	Digital coaxial output
c	DIGITAL IN OPTICAL 2	←	Digital optical output

Connecting an RI Dock

Not all iPod models output video.
For information about which iPod models are supported by the RI Dock, see the RI Dock's instruction manual.

■ **If Your iPod Supports Video:**

Connect your RI Dock's audio output jacks to the AV receiver's GAME/TV IN L/R jacks, and connect its video output jack to the AV receiver's GAME/TV IN V jack.

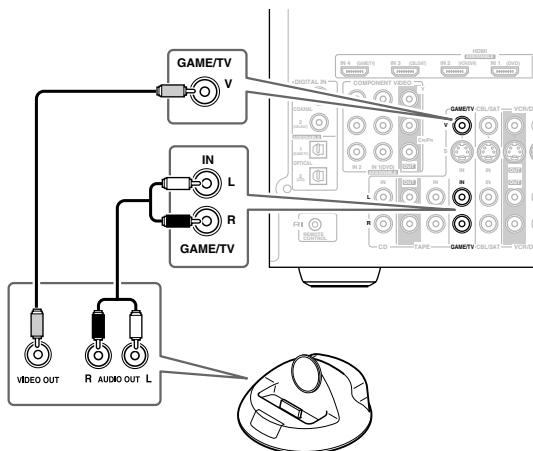

If you have an Onkyo DS-A1 RI Dock, connect its video output jack to the AV receiver's GAME/TV IN S jack.

■ **If Your iPod Doesn't Support Video:**

Connect your RI Dock's audio output jacks to the AV receiver's TAPE IN L/R jacks.

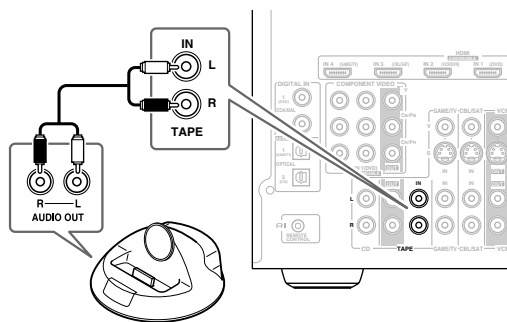

Notes:

- Enter the appropriate remote control code before using the AV receiver's remote controller for the first time (see page 88).
- Connect the RI Dock to the AV receiver with an **RI** cable (see page 36).
- Set the RI Dock's RI MODE switch to HDD or HDD/DOCK.
- Set the AV receiver's Input Display to DOCK (see page 45).
- See the RI Dock's instruction manual for more information.

Connecting Onkyo **RI** Components

Step 1: Make sure that each Onkyo component is connected to the AV receiver with an analog audio cable (RCA).

Step 2: Make the necessary **RI** connections (see illustration below).

Step 3: If you're using an MD, CDR, or RI DOCK component, change the Input Display (see page 45).

With **RI** (Remote Interactive), you can use the following special functions:

Auto Power On/Standby

When you start playback on a component connected via **RI**, if the AV receiver is on Standby, it will automatically turn on and select that component as the input source. Similarly, when the AV receiver is set to Standby, all components connected via **RI** will also go on Standby.

Direct Change

When playback is started on a component connected via **RI**, the AV receiver automatically selects that component as the input source. If your DVD player is connected to the AV receiver's DVD IN (multichannel input), you'll need to press the [MULTI CH] button repeatedly and select Multich to hear all channels (see page 47), as the Direct Change **RI** function selects the DVD IN FRONT L/R jacks.

Remote Control

You can use the AV receiver's remote controller to control your other **RI**-capable Onkyo components. You must enter the appropriate remote control code first (see page 88). And remember to point the remote controller at the AV receiver and not the other component.

Notes:

- Use only **RI** cables for **RI** connections. **RI** cables are supplied with Onkyo players (DVD, CD, etc.).
- Some components have two **RI** jacks. You can connect either one to the AV receiver. The other jack is for connecting additional **RI**-capable components.
- Connect only Onkyo components to **RI** jacks. Connecting other manufacturer's components may cause a malfunction.
- Some components may not support all **RI** functions. Refer to the manuals supplied with your other Onkyo components.
- While Zone 2 is on, the Auto Power On/Standby and Direct Change **RI** functions do not work.

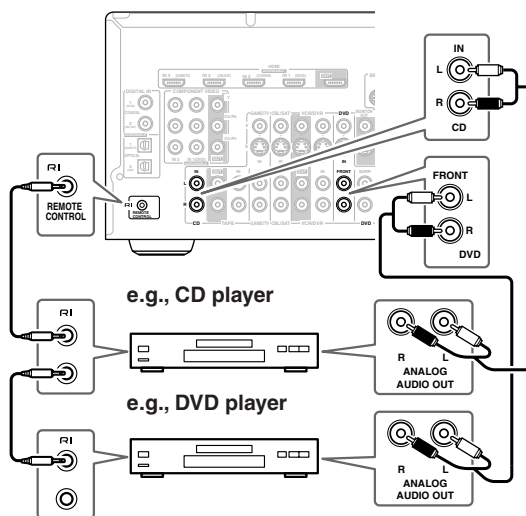

Turning On the AV Receiver

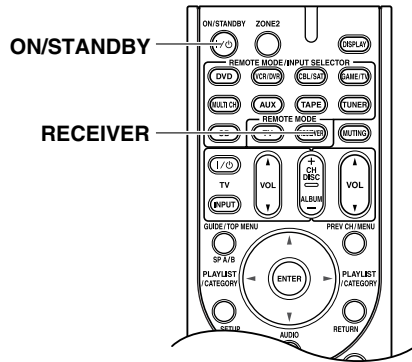
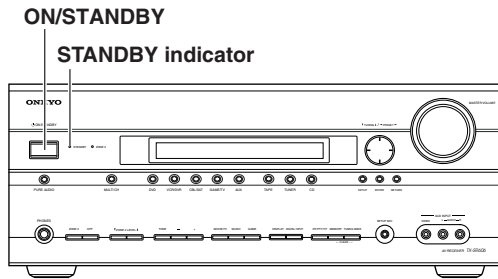

Connecting the Power Cord

- Before connecting the power cord, connect all your speakers and AV components.
- Plug the end of the power cord into a suitable wall outlet.
- Turning on the AV receiver may cause a momentary power surge that might interfere with other electrical equipment on the same circuit. If this is a problem, plug the AV receiver into a different branch circuit.

Turning On and Standby

The onscreen setup menus appear only on a TV that is connected to the HDMI OUT. If your TV is connected to the composite video or S-Video MONITOR OUT, or the COMPONENT VIDEO OUT, use the TX-SR606's display when changing settings.

AV receiver

Remote controller

On the AV receiver, press the [ON/STANDBY] button.

On the remote controller, press the [RECEIVER] REMOTE MODE button, followed by the [ON/STANDBY] button.

The AV receiver comes on, the display lights up, and the STANDBY indicator goes off.

To turn the AV receiver off, press the [ON/STANDBY] button, or press the remote controller's [ON/STANDBY] button. The AV receiver will enter Standby mode. To prevent any loud surprises the next time you turn on the AV receiver, turn down the volume before you turn it off.

Up and Running in a Few Easy Steps

To get your system up and running with the minimum of fuss, here's a few pointers to help you configure the AV receiver before you use it for the very first time. These settings only need to be made once.

■ Do the automatic speaker setup—this is essential!

See "Automatic Speaker Setup" on page 38.

■ Did you connect a component to an HDMI input, component video input, or digital audio input?

If you did, see "HDMI Input Setup" on page 43, "Component Video Input Setup" on page 44, or "Digital Input Setup" on page 44 respectively.

■ Did you connect an Onkyo MD recorder, CD recorder, or RI Dock?

If you did, see "Changing the Input Display" on page 45.

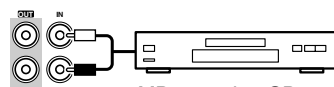
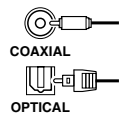
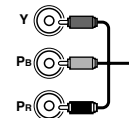
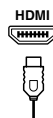

MD recorder, CD recorder, RI Dock

First Time Setup

This section explains the settings that you need to make before using the AV receiver for the very first time.

Automatic Speaker Setup

With the supplied calibrated microphone, Audyssey 2EQ[®] automatically determines the number of speakers connected, their size for purposes of bass management, optimum crossover frequencies to the subwoofer (if present), and distances from the primary listening position. Audyssey 2EQ then removes the distortion caused by room acoustics by capturing room acoustical problems over the listening area in both the frequency and time domain. The result is clear, well-balanced sound for everyone. Enabling Audyssey 2EQ allows you to also use Audyssey Dynamic EQ, which maintains the proper octave-to-octave balance at any volume level. (See page 70)

Measurement Positions

To create a listening environment in your home theater that all listeners will enjoy, Audyssey 2EQ takes measurements at up to three positions within the listening area.

- ① **First measurement point**
This is the center point of the listening area, or the listening position.
- ② **Second measurement point**
The right side of the listening area.
- ③ **Third measurement point**
The left side of the listening area.

The distances between points ① and ② and points ① and ③ must be at least 1 meter.

From the examples below, choose the listening area that best matches yours and place the microphone accordingly when prompted.

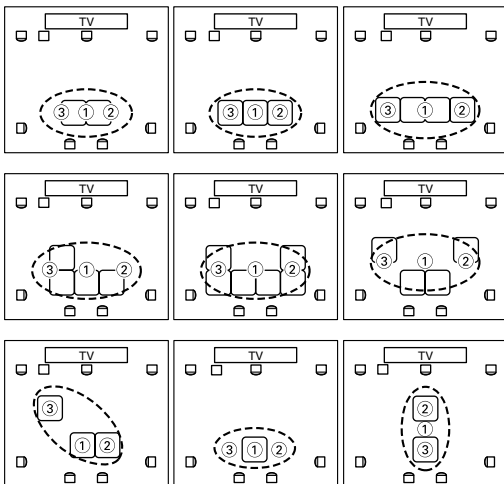

- : Listening area
- : Listening position

Using Audyssey 2EQ[®]

Notes:

- If any of your speakers is 4 ohms, change the Speaker Impedance setting before running the automatic speaker setup (see page 42).
- If the AV receiver is muted, it will be unmuted automatically when the automatic speaker setup starts.
- Automatic speaker setup cannot be performed while a pair of headphones is connected.
- It takes about 10 minutes to complete the automatic speaker setup for three positions. Total measurement time varies depending on the speakers.
- Do not connect or disconnect any speakers during the automatic speaker setup.

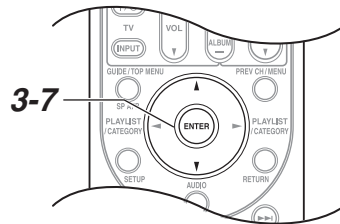
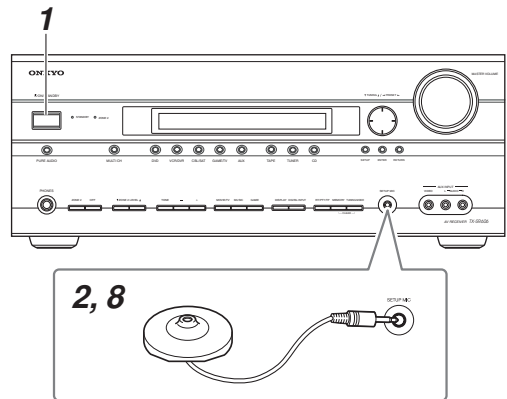

The onscreen setup menus appear only on a TV that is connected to the HDMI OUT. If your TV is connected to the composite video or S-Video MONITOR OUT, or the COMPONENT VIDEO OUT, use the TX-SR606's display when changing settings.

1

ON/STANDBY



Turn on the AV receiver and the connected TV.

On the TV, select the input to which the AV receiver is connected.

2



Put the speaker setup microphone at measurement point 1 (page 38), and connect it to the SETUP MIC jack.



Notes:

- Before starting Audyssey 2EQ® Automatic Speaker Setup, arrange the room and connect the speakers as you would for enjoying movies. Changes to the room after auto setup requires you run the auto setup again, as room EQ characteristics may have changed.
- When starting the automatic speaker setup, do not stand between the speakers and microphone, and avoid obstacles blocking the path between speakers and microphone. This will produce inaccurate results.
- Position the microphone at ear height of a seated listener with the microphone tip pointed directly at the ceiling using a tripod. Do not hold the microphone in your hand during measurements as this will produce inaccurate results.
- Make the room as quiet as possible. Background noise can disrupt the room measurements. Close windows, silence cell phones, televisions, radios, air conditioners, fluorescent lights, home appliances, light dimmers, or other devices.
- Cell phones should be turned off or placed away from all audio electronics during the measurement process as Radio Frequency Interference (RFI) may cause measurement disruptions (even if the cell phone is not in use).

3



Press [ENTER].

The automatic speaker setup starts.

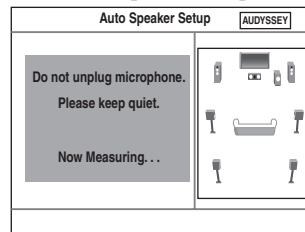

Test tones are played through each speaker as Audyssey 2EQ Automatic Speaker Setup runs. This process takes a few minutes. Please refrain from talking during measurements and do not stand between speakers and the microphone.

4

The following screen appears.

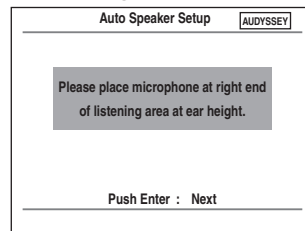

Move the speaker setup microphone to measurement point 2 (page 38), then press [ENTER].

Audyssey 2EQ performs more measurements. This takes a few minutes.

5

The following screen appears.

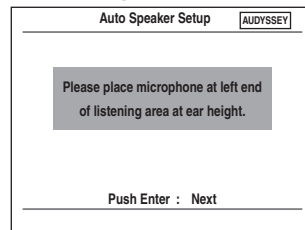

Move the speaker setup microphone to measurement point 3 (page 38), then press [ENTER].

Audyssey 2EQ performs more measurements. This takes a few minutes.

6

When the measurements are complete, the following screen appears.

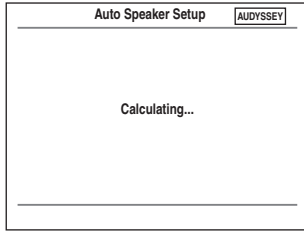

7

When the calculations are complete, the following screen appears.

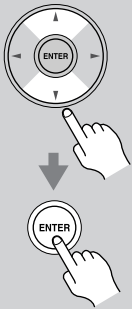
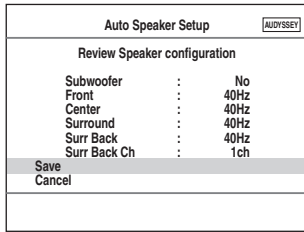

Use the Up and Down [▲]/[▼] buttons to select an option, and then press [ENTER].

The options are:

Save:

Save the calculated settings and exit the automatic speaker setup.

Cancel:

Cancel the automatic speaker setup.

Note:

- You can view the calculated settings for the speaker configuration, speaker distances, and speaker levels by using the Left and Right [◀]/[▶] buttons.

8

Disconnect the speaker setup microphone.

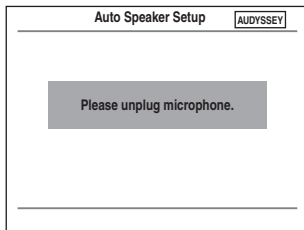

Error Messages

While the automatic speaker setup is in progress, one of the following error messages may appear:

❑ Ambient noise is too high

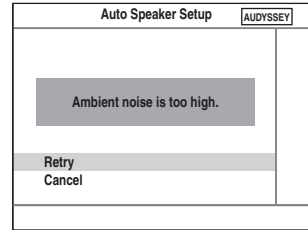

This message appears if the background noise is too loud and the measurements cannot be performed properly.

Remove the source of the noise and try again.

Retry: Return to the measured point immediately before and start set up again.

Cancel: Cancel the automatic speaker setup.

❑ Speaker Detect Errors

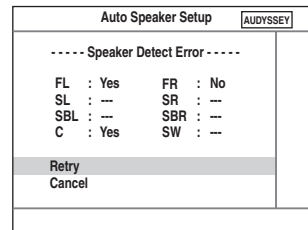

One of the front speakers has not been detected.

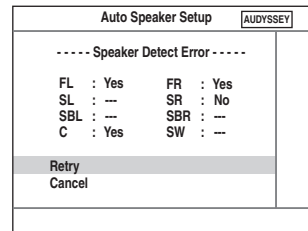

One of the surround speakers has not been detected.

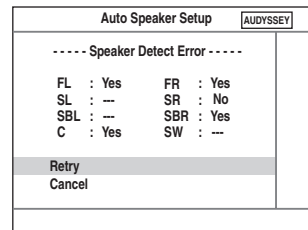

The surround back speakers have been detected but the surround speakers haven't.

Note:

- When the automatic speaker setup is complete, the Equalizer Settings (page 76) will be set to "Audyssey®."

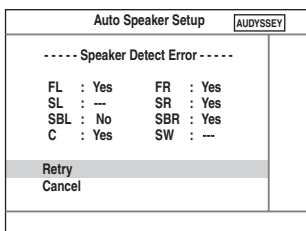

The right surround back speaker has been detected but the left surround back speaker hasn't.

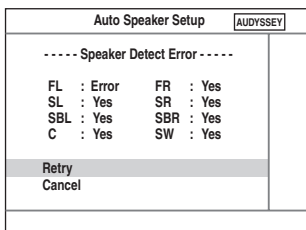

There is a problem with a speaker. The speaker may be broken or the subwoofer may be emitting sound that is too high.

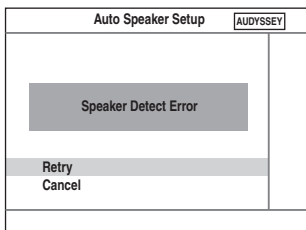

The number of speakers detected on the second or third measurement was different to the number detected on the first measurement.

Make sure speakers that cannot be detected are connected properly.

Retry: Return to step 2 and try again.

Cancel: Cancel the automatic speaker setup.

❑ Write Error

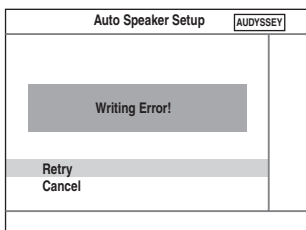

This message appears if saving fails.

Try saving again. If this message appears after 2 or 3 attempts, the AV receiver is probably malfunctioning. Contact your Onkyo dealer.

Retry: Return to step 2 and try again.

Cancel: Cancel the automatic speaker setup.

To Retry the Automatic Speaker Setup

Press the [ENTER] button.

Make sure speakers that cannot be detected are connected properly.



Changing the Speaker Settings Manually

If you wish to make changes to the settings found during the automatic speaker setup, follow the directions on pages 72–76.

Using a Powered Subwoofer

If you're using a powered subwoofer and it outputs very low-frequency sound at a low volume level, it may not be detected by the automatic speaker setup. If the subwoofer (SW) appears on the "SP Detect Result" screen as "No", increase the subwoofer's volume to the half-way point, set it to its highest crossover frequency, and then try running the automatic speaker setup again. Note that if the volume is set too high and the sound distorts, detection issues may occur, so use an appropriate volume level.

Speaker Settings

If you change these settings, you must run the automatic speaker setup again (see page 38).

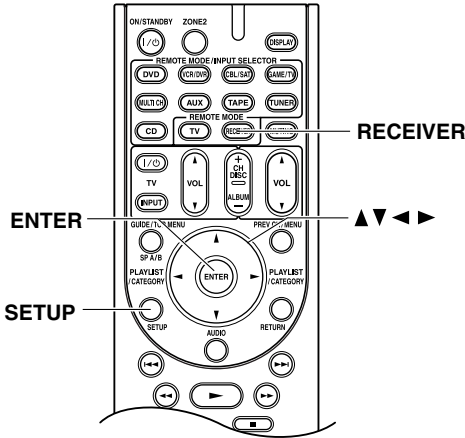

If the impedance of any speaker is 4 ohms or more but less than 6, set the Speaker Impedance to 4 ohms.

North American models do not support speakers with an impedance of less than 6 ohms.

To use bi-amping, you must change the Speaker Type setting. For hookup information, see page 17.

Notes:

- When bi-amping is used, the AV receiver is able to drive up to 5.1 speakers in the main room.
- Before you change these settings, turn down the volume.

The onscreen setup menus appear only on a TV that is connected to the HDMI OUT. If your TV is connected to the composite video or S-Video MONITOR OUT, or the COMPONENT VIDEO OUT, use the TX-SR606's display when changing settings.

1 Press the [RECEIVER] button, followed by the [SETUP] button. The main menu appears onscreen. If the main menu doesn't appear, make sure the appropriate external input is selected on your TV.

2 Use the Up and Down [▲]/[▼] buttons to select "2. Speaker Setup," and then press [ENTER].

3 Use the Up and Down [▲]/[▼] buttons to select "1. Speaker Settings," and then press [ENTER].

4 Use the Up and Down [▲]/[▼] buttons to select "Speaker Impedance," and use the Left and Right [◀]/[▶] buttons to select:

4 ohms: Select if the impedance of any speaker is 4 ohms or more but less than 6.

6 ohms: Select if the impedances of all speakers are between 6 and 16 ohms.

5 Use the Up and Down [▲]/[▼] buttons to select "Speaker Type," and use the Left and Right [◀]/[▶] buttons to select:

Normal: Select this if you've connected your front speakers normally.

Bi-Amp: Select this if you've connected your front speakers for bi-amped operation.

6 Press the [SETUP] button. Setup closes.

Note:

- This procedure can also be performed on the AV receiver by using its [SETUP], [ENTER], and arrow buttons.

HDMI Input Setup

If you connect a video component to an HDMI IN, you must assign that input to an input selector. For example, if you connect your DVD player to HDMI IN 1, you must assign HDMI IN 1 to the DVD input selector.

These are the default assignments.

Input selector	Video input
DVD	HDMI1
VCR/DVR	HDMI2
CBL/SAT	HDMI3
GAME/TV	HDMI4
AUX	-----
TAPE	-----
CD	-----

1 Press the [RECEIVER] button, followed by the [SETUP] button. The main menu appears onscreen. If the main menu doesn't appear, make sure the appropriate external input is selected on your TV.



2 Use the Up and Down [▲]/[▼] buttons to select "1. Input Assign," and then press [ENTER].

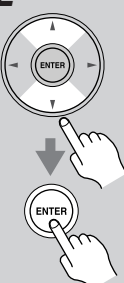

3 Use the Up and Down [▲]/[▼] buttons to select "1. HDMI Input," and then press [ENTER].

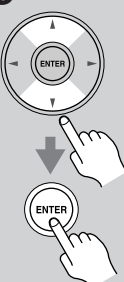

4 Use the Up and Down [▲]/[▼] buttons to select an input selector, and use the Left and Right [◀]/[▶] buttons to select:



HDMI1: Select if the video component is connected to HDMI IN 1.
HDMI2: Select if the video component is connected to HDMI IN 2.
HDMI3: Select if the video component is connected to HDMI IN 3.
HDMI4: Select if the video component is connected to HDMI IN 4.
 -----: Select if you're not using the HDMI OUT.

5 Press the [SETUP] button. Setup closes.



Notes:

- Each HDMI IN cannot be assigned to more than one input selector.
- When an HDMI IN is assigned to an input selector as explained here, the digital audio input for that input selector is automatically set to the same HDMI IN. See "Digital Input Setup" on page 44.
- This procedure can also be performed on the AV receiver by using its [SETUP], [ENTER], and arrow buttons.

Component Video Input Setup

If you connect a video component to a COMPONENT VIDEO IN, you must assign that input to an input selector. For example, if you connect your DVD player to COMPONENT VIDEO IN 2, you must assign COMPONENT VIDEO IN 2 to the DVD input selector.

These are the default assignments.

Input selector	Video input
DVD	IN1
VCR/DVR	-----
CBL/SAT	IN2
GAME/TV	-----
AUX	-----
TAPE	-----
CD	-----

1



Press the [RECEIVER] button, followed by the [SETUP] button.
The main menu appears onscreen. If the main menu doesn't appear, make sure the appropriate external input is selected on your TV.

2



Use the Up and Down [▲]/[▼] buttons to select "1. Input Assign," and then press [ENTER].

3



Use the Up and Down [▲]/[▼] buttons to select "2. Component Video Input," and then press [ENTER].

4



Use the Up and Down [▲]/[▼] buttons to select an input selector, and use the Left and Right [◀]/[▶] buttons to select:

IN1: Select if the video component is connected to COMPONENT VIDEO IN 1.

IN2: Select if the video component is connected to COMPONENT VIDEO IN 2.

-----: Select if you're not using the COMPONENT VIDEO OUT.

5



Press the [SETUP] button.
Setup closes.

Note:

- This procedure can also be performed on the AV receiver by using its [SETUP], [ENTER], and arrow buttons.

Digital Input Setup

If you connect a component to a digital audio input, you must assign that input to an input selector. For example, if you connect your CD player to OPTICAL IN 1, you must assign OPTICAL IN 1 to the CD input selector.

These are the default assignments.

Input selector	Audio input
DVD	COAX1
VCR/DVR	-----
CBL/SAT	COAX2
GAME/TV	OPT1
AUX	-----
TAPE	-----
CD	OPT2

1

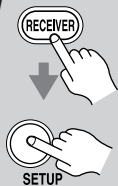

Press the [RECEIVER] button, followed by the [SETUP] button.
The main menu appears onscreen. If the main menu doesn't appear, make sure the appropriate external input is selected on your TV.

2



Use the Up and Down [▲]/[▼] buttons to select “1. Input Assign,” and then press [ENTER].

3



Use the Up and Down [▲]/[▼] buttons to select “3. Digital Audio Input,” and then press [ENTER].

4

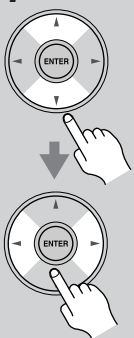

Use the Up and Down [▲]/[▼] buttons to select an input selector, and then use the Left and Right [◀]/[▶] buttons to select:

COAX1: Select if the component is connected to DIGITAL IN COAXIAL 1.

COAX2: Select if the component is connected to DIGITAL IN COAXIAL 2.

OPT1: Select if the component is connected to DIGITAL IN OPTICAL 1.

OPT2: Select if the component is connected to DIGITAL IN OPTICAL 2.

-----: Select if the component is connected to an analog input.

5



Press the [SETUP] button. Setup closes.

- When an HDMI IN is assigned to an input selector in “HDMI Input Setup” on page 43, this input assignment is automatically set to the same HDMI IN. And in addition to the usual inputs (e.g., COAX1, COAX2, etc.), you can also select HDMI inputs. If you change the input assignment from an HDMI IN to one of the other inputs (e.g., COAX1 or COAX2), be sure to set the “Automatic Audio Input Selection Setup” on

page 46 to the same input (e.g., COAX1 (Auto) or COAX2 (Auto)).

- This procedure can also be performed on the AV receiver by using its [SETUP], [ENTER], and arrow buttons.

Changing the Input Display

If you connect an **RI**-capable Onkyo MiniDisc recorder, CD recorder, or RI Dock to the TAPE IN/OUT jacks, or connect an RI Dock to the GAME/TV IN jacks, for **RI** to work properly, you must change this setting.

This setting can only be changed on the AV receiver.

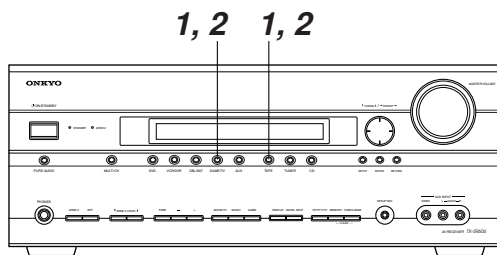

iPod photo: If you’re using an iPod photo with the DS-A1 Remote Interactive Dock, connect the DS-A1 to the GAME/TV IN jacks.

1



Press the [TAPE] or [GAME/TV] input selector button so that “TAPE” or “GAME/TV” appears on the display.

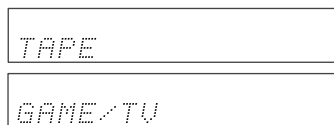

2



Press and hold down the [TAPE] or [GAME/TV] input selector button (about 3 seconds) to change the setting.

Repeat this step to select MD, CDR, or DOCK.

For the TAPE input selector, the setting changes in this order:

TAPE → MD → CDR
 ↑ DOCK ↓

For the GAME/TV input selector, the setting changes in this order:

GAME/TV ↔ DOCK

Notes:

- DOCK can be selected for the TAPE input selector or GAME/TV input selector, but not both at the same time.

Automatic Audio Input Selection Setup

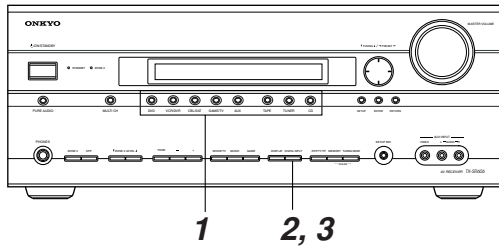

When an input source is selected, the AV receiver checks the relevant audio inputs for the presence of an audio signal and automatically selects an input. With this setting, you can specify which audio inputs the AV receiver will check for signals.

1

Press the input selector button for the input selector whose setting you want to change.

The setting for the TUNER input selector cannot be changed and is fixed at "Analog."

2

Press the [DIGITAL INPUT] button.

The current setting is displayed.

DVD: HDMI 1 (Auto)

3

DIGITAL INPUT



Press the [DIGITAL INPUT] button repeatedly to select an option.

HDMIx (Auto):

This option can be selected when an HDMI input is assigned to an input selector (page 43). When this option is selected, the relevant HDMI, digital, and analog inputs will be checked for the presence of an audio signal. If signals are present at more than one input, the inputs will be selected in the following order of priority: HDMI, digital, analog.

COAXx (Auto)/OPTx (Auto):

This option can be selected when a digital input is assigned to an input selector (page 44). When this option is selected, the relevant digital and analog inputs will be checked for the presence of an audio signal. If signals are present at more than one input, the inputs will be selected in the following order of priority: digital, analog. Any audio signals present at the HDMI inputs will not be output.

Analog:

When this option is selected, the signal from the relevant analog audio input is output. Any audio signals present at HDMI or digital inputs will not be output.

Note:

- You can select a different option for each input selector.

Playing Your AV Components

Basic AV Receiver Operation

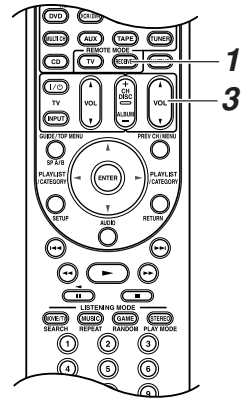
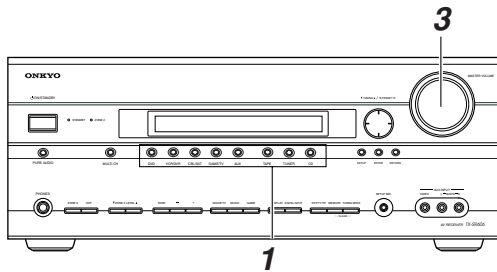

1

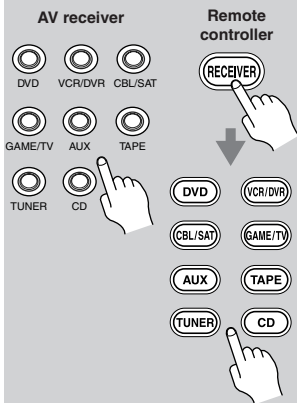

Use the AV receiver's input selector buttons to select an input source.

To select an input source with the remote controller, press its INPUT SELECTOR buttons.

To listen to a DVD player connected to the multichannel DVD input (page 25), press the AV receiver's [MULTI CH] button. The MULTI CH indicator will appear on the display.

Note:

- While the multichannel DVD input is selected, the Speaker Configuration settings on page 72 are ignored, and signals from the multichannel input are fed to the speakers as they are.

2

Start playback on the source component.

To watch a DVD or other video source, on your TV, select the video input that's connected to the AV receiver's COMPONENT VIDEO OUT, HDMI OUT, or MONITOR OUT.

On some DVD players, you may need to change the digital or HDMI audio output settings.

3

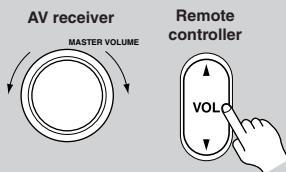

To adjust the volume, use the MASTER VOLUME control or the remote controller's [VOL] button.

Since the AV receiver is designed for home theaters, it has a wide volume range for precise adjustment. The volume can be set to Min, 1 through 79, or Max.

4

Select a listening mode and enjoy!

See "Using the Listening Modes" on page 57.

Common Functions

This section explains functions that can be used with any input source.

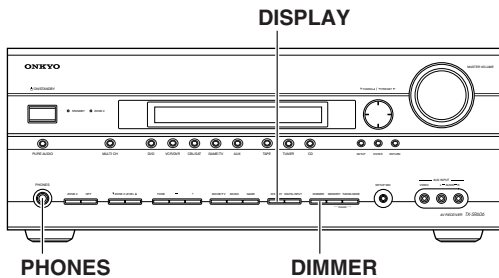
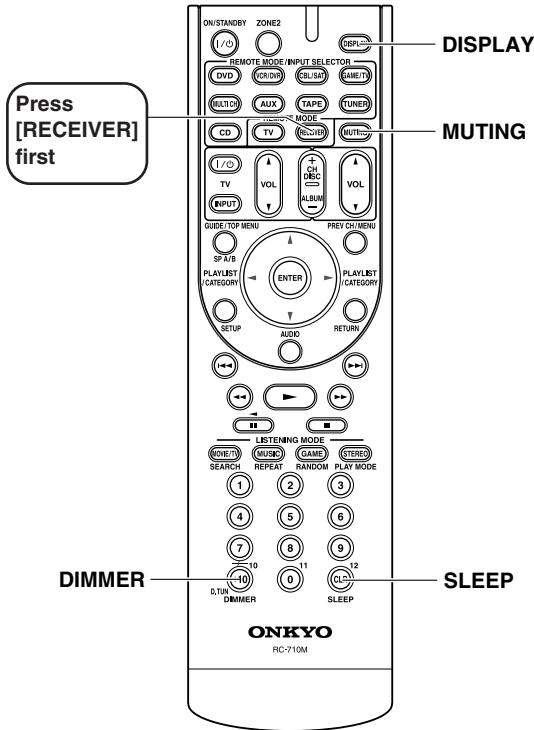

Setting the Display Brightness

You can adjust the brightness of the display.

Press the [RECEIVER] REMOTE MODE button, and then press the remote controller's [DIMMER] button repeatedly to select: dim, dimmer, or normal brightness.

You can also use the AV receiver's [DIMMER] button (not European models).

Muting the AV Receiver

You can temporarily mute the output of the AV receiver.

Press the [RECEIVER] REMOTE MODE button, and then press the remote controller's [MUTING] button.

The output is muted and the MUTING indicator flashes on the display.

To unmute the AV receiver, press the remote controller's [MUTING] button again, or adjust the volume. The output is unmuted and the MUTING indicator goes off. Muting is cancelled when the AV receiver is set to Standby.

Using the Sleep Timer

With the sleep timer, you can set the AV receiver so that it turns off automatically after a specified period.

Press the [RECEIVER] REMOTE MODE button, and then press the remote controller's [SLEEP] button repeatedly to select the required sleep time.

You can set the sleep time from 90 to 10 minutes in 10 minute steps.

The SLEEP indicator appears on the display when the sleep timer has been set, as shown. The specified sleep time appears on the display for about 5 seconds, then the previous display reappears.

SLEEP indicator

To cancel the sleep timer, press the [SLEEP] button repeatedly until the SLEEP indicator disappears.

To check the remaining sleep time, press the [SLEEP] button. Note that if you press the [SLEEP] button while the sleep time is being displayed, you'll shorten the sleep time by 10 minutes.

Using Headphones

For private listening, you can connect a pair of stereo headphones (1/4-inch phone plug) to the AV receiver's PHONES jack.

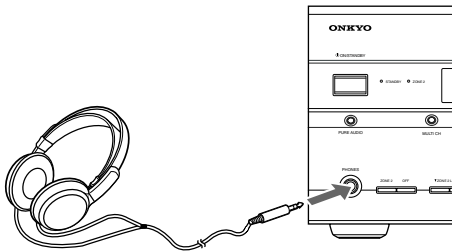

Notes:

- Always turn down the volume before connecting your headphones.
- While the headphones plug is inserted in the PHONES jack, the speakers are turned off. (The Powered Zone 2 speakers are not turned off.)
- When you connect a pair of headphones, the listening mode is set to Stereo, unless it was already set to Pure Audio, Mono, Stereo, or Direct, in which case it stays the same.
- When the multichannel DVD input is selected, only the front left and front right channels can be heard in the headphones.

Displaying Source Information

You can display various information about the current input source as follows.

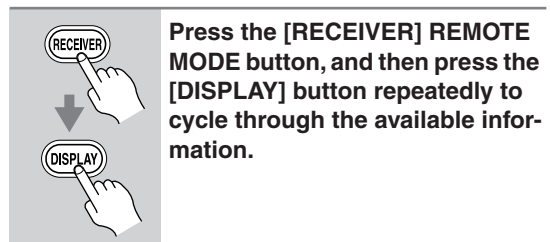

Note:

- This procedure can also be performed on the AV receiver by using its [DISPLAY] button.

The following information can typically be displayed:

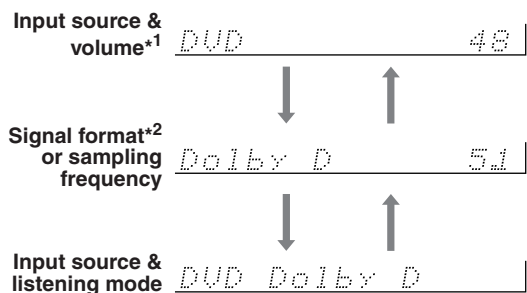



*1 When AM or FM radio is used, the band, preset number, and frequency are displayed.

*2 If the input signal is analog, or AM or FM radio is selected, no format information is displayed. If the input signal is PCM, the sampling frequency is displayed. If the input signal is digital but not PCM, the signal format is displayed. Information is displayed for about 3 seconds, then the previous display reappears.

Specifying the Digital Signal Format

The following table shows the display indicator for each digital signal format.

Format	Display
Dolby Digital	 D
DTS	
PCM	PCM

Normally, the AV receiver detects the format of digital input signals automatically. However, if you experience either of the following issues when playing PCM or DTS sources, you can specify the signal format manually.

- If the beginnings of tracks from a PCM source are cut off, try the PCM setting.
- If noise is produced when fast forwarding or rewinding a DTS CD, try the DTS setting.

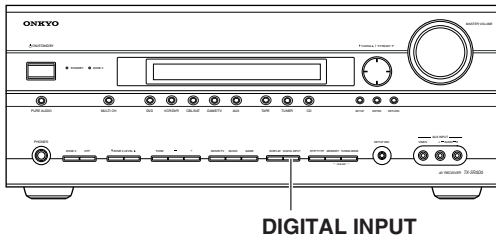

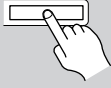
<p>1</p> <p>DIGITAL INPUT</p> 	<p>Press and hold the AV receiver's [DIGITAL INPUT] button for about 3 seconds.</p>
<p>2</p> <p>DIGITAL INPUT</p> 	<p>While “Auto” is displayed (about 3 seconds), press the [DIGITAL INPUT] button repeatedly to select: PCM, DTS, or Auto.</p> <p>PCM: Only 2-channel PCM format input signals will be heard. If the input signal is not PCM, the PCM indicator will flash and there will be no sound.</p> <p>DTS: Only DTS (but not DTS-HD) format input signals will be heard. If the input signal is not DTS, the DTS indicator will flash and there will be no sound.</p> <p>Auto (default): The format is detected automatically. If no digital input signal is present, the corresponding analog input is used instead.</p>

Listening to the Radio

AM Frequency Step Setup (on some models)

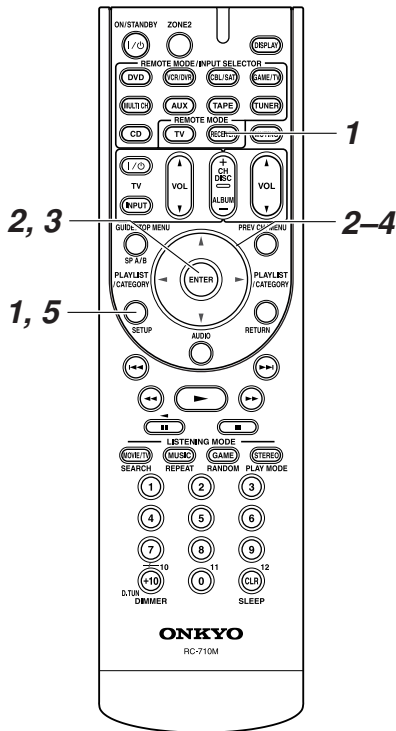

For AM tuning to work properly, you must specify the AM frequency step used in your area. Note that when this setting is changed, all radio presets are deleted.

3

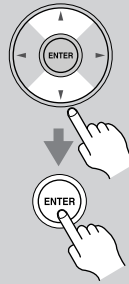

Use the Up and Down [**▲**]/[**▼**] buttons to select “3. Tuner,” and then press [ENTER].

4



Use the Left and Right [**◀**]/[**▶**] buttons to select:

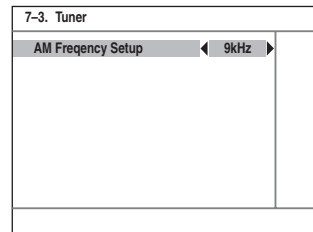

10kHz: Select if 10kHz steps are used in your area.

9kHz: Select if 9kHz steps are used in your area.

5



Press the [SETUP] button.

Setup closes.

1



Press the [RECEIVER] button, followed by the [SETUP] button.

The main menu appears onscreen. If the main menu doesn't appear, make sure the appropriate external input is selected on your TV.

2



Use the Up and Down [**▲**]/[**▼**] buttons to select “7. Hardware-Setup,” and then press [ENTER].

Note:

- This procedure can also be performed on the AV receiver by using its [SETUP], [ENTER], and arrow buttons.

Listening to AM/FM Stations

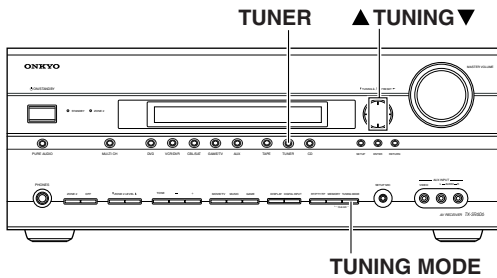

With the built-in tuner, you can enjoy AM and FM radio stations and store your favorite stations as presets for easy selection.



Use the [TUNER] input selector button to select AM or FM.
In this example, FM has been selected.

Band	Frequency
FM	87.5 MHz ---

(Actual display depends on country.)

Tuning into AM/FM Radio Stations

■ **Auto Tuning Mode**

1

TUNING MODE



Press the [TUNING MODE] button so that the AUTO indicator appears on the display.

2

TUNING ▲



Press the TUNING Up or Down [▲]/[▼] button.
Searching stops when a station is found.

When tuned into a station, the TUNED indicator appears. When tuned into a stereo FM station, the FM STEREO indicator also appears.

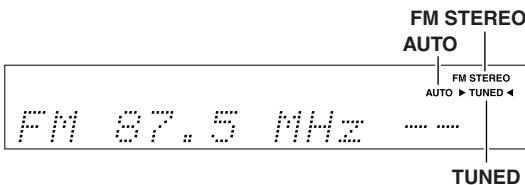

■ **Manual Tuning Mode**

1

TUNING MODE



Press the [TUNING MODE] button so that the AUTO indicator disappears from the display.

2

TUNING ▲



Press and hold the TUNING Up or Down [▲]/[▼] button.
The frequency stops changing when you release the button.
Press the button repeatedly to change the frequency one step at a time.

The North American model changes FM frequency in 0.2MHz steps, 10kHz steps for AM. For other models it's 0.05MHz steps for FM and 9kHz (or 10kHz) steps for AM.

In Manual Tuning mode, FM stations will be in mono.

Tuning into Weak FM Stereo Stations

If the signal from a stereo FM station is weak, it may be impossible to get good reception. In this case, switch to Manual Tuning mode and listen to the station in mono.

Note:

- You can also use the remote controller's Up and Down [▲]/[▼] buttons to tune the radio.

Listening to the Radio—Continued

■ Tuning into Stations by Frequency

You can tune into AM and FM stations directly by entering the appropriate frequency.

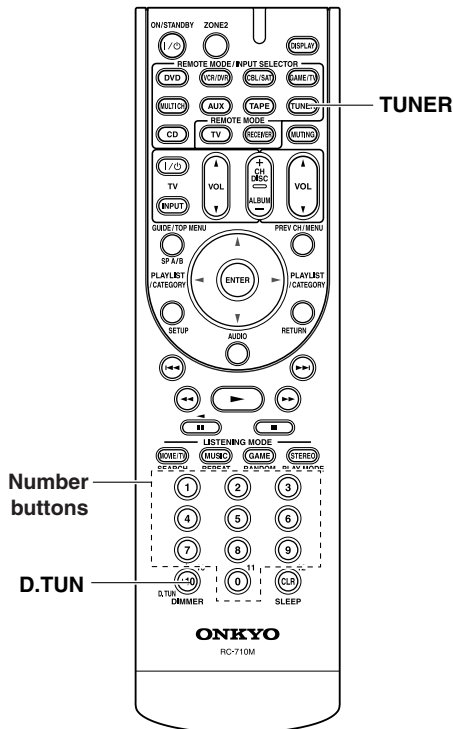

Displaying AM/FM Radio Information

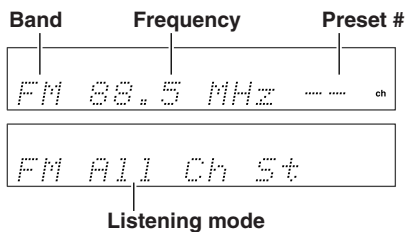
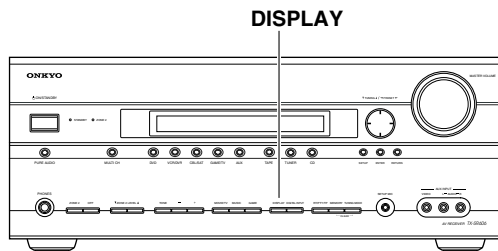

1

Press the [TUNER] button repeatedly to select AM or FM, followed by the [D.TUN] button.

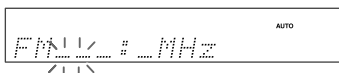
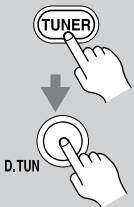

(Actual display depends on country.)

2

Within 8 seconds, use the number buttons to enter the frequency of the radio station.

For example, to tune to 87.5 (FM), press 8, 7, 5.

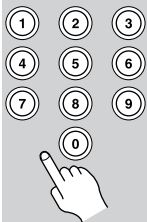

Presetting AM/FM Stations

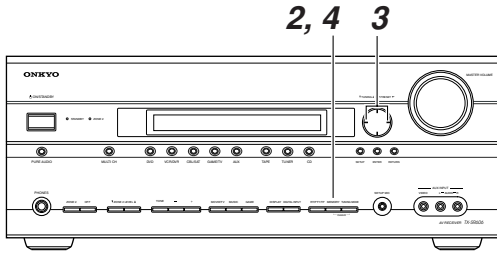

You can store a combination of up to 40 of your favorite AM and FM radio stations.

- 1** Tune into the AM or FM station you want to store as a preset.
- 2** Press the [MEMORY] button. The preset number flashes.
- 3** While the preset number is flashing (about 8 seconds), use the PRESET [◀/▶] buttons to select a preset from 1 through 40.
- 4** Press the [MEMORY] button again to store the station. The station is stored and the preset number stops flashing. Repeat this procedure for all of your favorite stations.

Deleting Presets

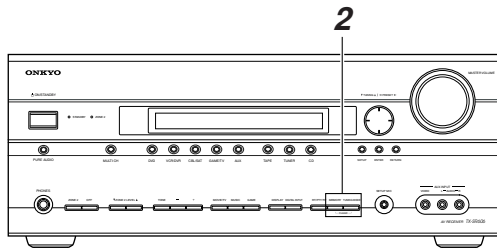

- 1** Select the preset that you want to delete. See the next section.

- 2** While holding down the [MEMORY] button, press the [TUNING MODE] button. The preset is deleted and its number disappears from the display.

Selecting Presets

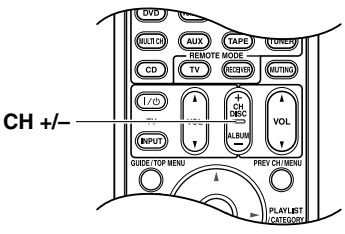
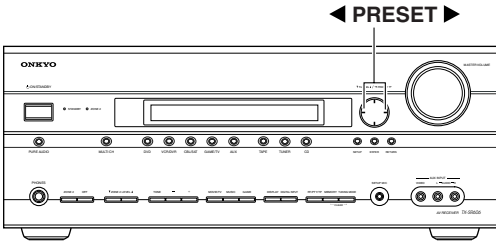

- To select a preset, use the PRESET [◀/▶] buttons or the remote controller's CH [+/-] button.
-
- You can also use the remote controller's number buttons to select a preset directly.
-

Using RDS (European models only)

RDS only works in areas where RDS broadcasts are available. When tuned to an RDS station, the RDS indicator appears.

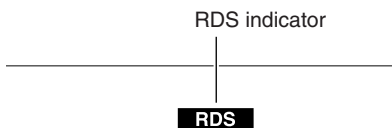

■ What is RDS?

RDS stands for *Radio Data System* and is a method of transmitting data in FM radio signals. It was developed by the European Broadcasting Union (EBU) and is available in most European countries. RDS is approved by the National Radio Systems Committee (NRSC) and is available in North America.

Many FM stations use it these days. In addition to displaying text information, RDS can also help you find radio stations by type (e.g., news, sport, rock, etc.).

The AV receiver supports four types of RDS information:

PS (Program Service)

When tuned to an RDS station that's broadcasting PS information, the station's name will be displayed. Pressing the [DISPLAY] button will display the frequency for 3 seconds.

RT (Radio Text)

When tuned to an RDS station that's broadcasting text information, the text will be shown on the display (see page 56).

PTY (Program Type)

This allows you to search RDS radio stations by type (see page 56).

TP (Traffic Program)

This allows you to search for RDS radio stations that broadcast traffic information (see page 56).

Notes:

- In some cases, the characters displayed on the AV receiver may not be identical to those broadcast by the radio station. Also, unexpected characters may be displayed when unsupported characters are received. This is not a malfunction.
- If the signal from an RDS station is weak, RDS data may be displayed intermittently or not at all.

RDS Program Types (PTY)

Type	Display
None	None
News reports	News
Current affairs	Affairs
Information	Info
Sport	Sport
Education	Educate
Drama	Drama
Culture	Culture
Science and technology	Science
Varied	Varied
Pop music	Pop M
Rock music	Rock M
Middle of the road music	Easy M
Light classics	Light M
Serious classics	Classics
Other music	Other M
Weather	Weather
Finance	Finance
Children's programmes	Children
Social affairs	Social
Religion	Religion
Phone in	Phone In
Travel	Travel
Leisure	Leisure
Jazz music	Jazz
Country music	Country
National music	Nation M
Oldies music	Oldies
Folk music	Folk M
Documentary	Document
Alarm test	TEST
Alarm	Alarm!

Displaying Radio Text (RT)

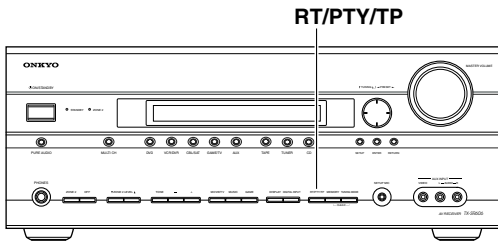

When tuned to an RDS station that's broadcasting text information, the text can be displayed.

Press the [RT/PTY/TP] button once.
The RT information scrolls across the display.

Notes:

- The message "Waiting" may appear while the AV receiver waits for the RT information.
- If the message "No Text Data" appears on the display, no RT information is available.

Finding Stations by Type (PTY)

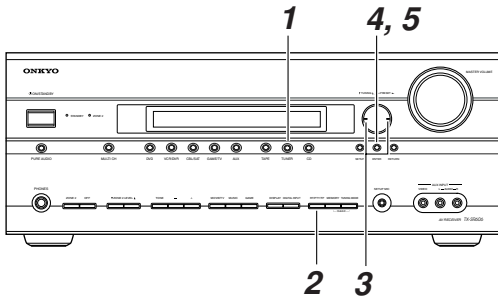

You can search for radio stations by type.

<p>1</p> <p>TUNER</p>	<p>Use the [TUNER] input selector button to select FM.</p>
<p>2</p> <p>RT/PTY/TP</p>	<p>Press the [RT/PTY/TP] button twice. The current program type appears on the display.</p>
<p>3</p> <p>PRESET</p>	<p>Use the PRESET [◀]/[▶] buttons to select the type of program you want. See the table on page 55.</p>

<p>4</p> <p>ENTER</p>	<p>To start the search, press [ENTER]. The AV receiver searches until it finds a station of the type you specified, at which point it stops briefly before continuing with the search.</p>
<p>5</p> <p>ENTER</p>	<p>When a station you want to listen to is found, press [ENTER]. If no stations are found, the message "Not Found" appears.</p>

Listening to Traffic News (TP)

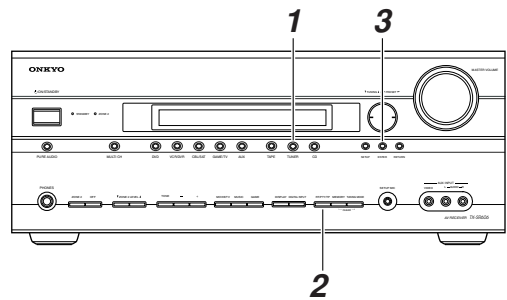

You can search for stations that broadcast traffic news.

<p>1</p> <p>TUNER</p>	<p>Use the [TUNER] input selector button to select FM.</p>
<p>2</p> <p>RT/PTY/TP</p>	<p>Press the [RT/PTY/TP] button three times. If the current radio station is broadcasting TP (Traffic Program), "[TP]" will appear on the display and traffic news will be heard as and when it's broadcast. If "TP" without square brackets appears, this means that the station is not broadcasting TP.</p>
<p>3</p> <p>ENTER</p>	<p>To locate a station that is broadcasting TP, press [ENTER]. The AV receiver searches until it finds a station that's broadcasting TP. If no stations are found, the message "Not Found" appears.</p>

Using the Listening Modes

Selecting the Listening Modes

For a description of each listening mode, see “About the Listening Modes” on page 64.

- The Dolby Digital and DTS listening modes can only be selected if your DVD player is connected to the AV receiver with a digital audio connection (coaxial, optical, or HDMI).
- The listening modes you can select depends on the format of the input signal. To check the format, see “Displaying Source Information” on page 49.
- While a pair of headphones is connected, you can only select the Pure Audio, Mono, Direct, or Stereo listening mode.

Selecting on the AV Receiver

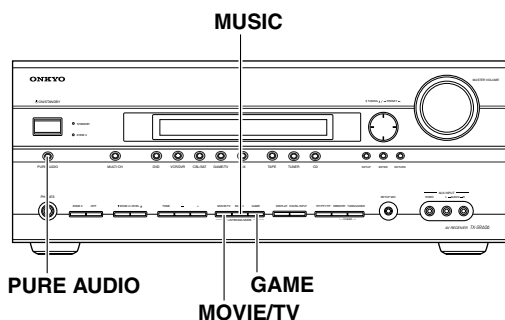

- **[PURE AUDIO] button (not North American model)**
This button selects the Pure Audio listening mode. When this mode is selected, the AV receiver’s display is turned off and only the HDMI outputs output video signals. Pressing this button again will select the previous listening mode.
- **[MOVIE/TV] button**
This button selects the listening modes intended for use with movies and TV.
- **[MUSIC] button**
This button selects the listening modes intended for use with music.
- **[GAME] button**
This button selects the listening modes intended for use with video games.

Selecting with the Remote Controller

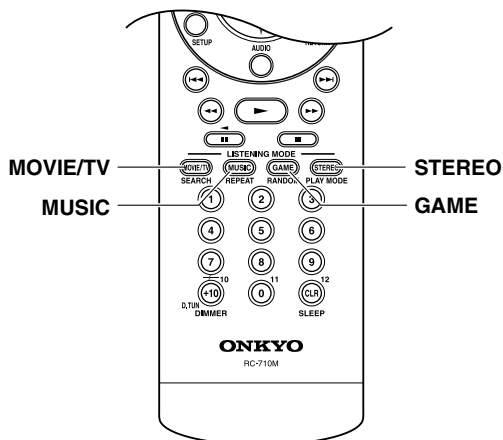

- **[MOVIE/TV] button**
This button selects the listening modes intended for use with movies and TV.
- **[MUSIC] button**
This button selects the listening modes intended for use with music.
- **[GAME] button**
This button selects the listening modes intended for use with video games.
- **[STEREO] button**
This button selects the Stereo listening mode and All Channel Stereo listening mode.

Listening Modes Available for Each Source Format

Analog and PCM Sources

Button	Source format Media	PCM		Multi channel Analog	Multichannel					
		32–96 kHz ^{*1}	176.4/192kHz ^{*2}		32–96kHz ^{*1}			176.4/192kHz ^{*2}		
					Multi-channel	2ch	Mono/Multiplex	Multi-channel	2ch	Mono/Multiplex
Listening Mode	CD, TV, radio,	DVD		DVD			DVD			
[PURE AUDIO]	Pure Audio ^{*3}	✓	✓	✓	✓	✓	✓	✓	✓	✓
[MOVIE/ TV]	Mono	✓			✓	✓	✓			
	Multichannel			✓	✓					
	Neo:6				✓ ^{*5}					
	Dolby PLII Movie/ Dolby PLIIx Movie ^{*4}	✓			✓ ^{*5}	✓				
	DolbyEX				✓ ^{*5}					
	Neo:6 Cinema	✓				✓				
	MonoMovie ^{*6 *7}	✓			✓	✓	✓			
	TV Logic ^{*6 *7}	✓			✓	✓	✓			
	AllChStereo	✓			✓	✓	✓			
	FullMono	✓			✓	✓	✓			
T-D ^{*7}	✓			✓	✓	✓				
[MUSIC]	Pure Audio ^{*3}	✓	✓	✓	✓	✓	✓	✓	✓	✓
	Direct	✓	✓	✓	✓	✓	✓	✓	✓	✓
	Stereo	✓	✓		✓	✓	✓	✓	✓	✓
	Multichannel			✓	✓					
	Neo:6				✓ ^{*5}					
	Dolby PLII Music/ Dolby PLIIx Music ^{*4}	✓			✓ ^{*5}	✓				
	DolbyEX				✓ ^{*5}					
	Neo:6 Music	✓				✓				
	Orchestra ^{*6 *7}	✓			✓	✓	✓			
	Unplugged ^{*6 *7}	✓			✓	✓	✓			
	Studio-Mix ^{*6 *7}	✓			✓	✓	✓			
	AllChStereo	✓			✓	✓	✓			
FullMono	✓			✓	✓	✓				
[GAME]	Multichannel			✓	✓			✓		
	Neo:6				✓ ^{*5}					
	Dolby PLII Game/ Dolby PLIIx Game ^{*4}	✓				✓				
	DolbyEX				✓ ^{*5}					
	AllChStereo	✓			✓	✓	✓			
	FullMono	✓			✓	✓	✓			
	T-D ^{*7}	✓			✓	✓	✓			
[STEREO]	AllChStereo	✓			✓	✓	✓			
	Stereo	✓	✓		✓	✓	✓	✓	✓	✓

*1. 32/44,1/48/88.2/96kHz

*2. DVD-Audio discs output multichannel 176.4/192kHz PCM only via HDMI.

*3. North American model doesn't have Pure Audio listening mode.

*4. If there are no surround back speakers, or Powered Zone 2 is being used, Dolby Pro Logic II is used.

*5. Cannot be selected with some source formats.

*6. Available only when using surround speakers.

*7. PCM of 64kHz, 88.2kHz, and 96kHz are processed at 32kHz, 44.1kHz, and 48kHz respectively.

Requires 6.1/7.1 speakers. Not available while Powered Zone 2 is being used.

Requires 7.1 speakers. Not available while Powered Zone 2 is being used.

Using the Listening Modes—Continued

Dolby Digital and Dolby Digital Plus Sources

Button	Source format	Dolby Digital			Dolby Digital Plus		
		Multichannel	2ch	Mono/ Multiplex	Multichannel	2ch	Mono/ Multiplex
	Media	DVD, DTV, etc.			Blu-ray, HD DVD		
Listening Mode							
[PURE AUDIO]	Pure Audio ^{*1}	✓	✓	✓	✓	✓	✓
[MOVIE/TV]	Mono	✓	✓	✓	✓	✓	✓
	DolbyDigital	✓					
	DolbyDigital Plus				✓ ^{*2}		
	Neo:6	✓ ^{*4}			✓ ^{*4}		
	Dolby PLII Movie/Dolby PLIIx Movie ^{*3}	✓ ^{*4}	✓		✓ ^{*4}	✓	
	DolbyEX	✓ ^{*4}			✓ ^{*4}		
	Neo:6 Cinema		✓			✓	
	MonoMovie ^{*5}	✓	✓	✓			
	TV Logic ^{*5}	✓	✓	✓			
	AllChStereo	✓	✓	✓	✓	✓	✓
	FullMono	✓	✓	✓	✓	✓	✓
T-D	✓	✓	✓				
[MUSIC]	Pure Audio ^{*1}	✓	✓	✓	✓	✓	✓
	Direct	✓	✓	✓	✓	✓	✓
	Stereo	✓	✓	✓	✓	✓	✓
	DolbyDigital	✓					
	DolbyDigital Plus				✓ ^{*2}		
	Neo:6	✓ ^{*4}			✓ ^{*4}		
	Dolby PLII Music/Dolby PLIIx Music ^{*3}	✓ ^{*4}	✓		✓ ^{*4}	✓	
	DolbyEX	✓ ^{*4}			✓ ^{*4}		
	Neo:6 Music		✓			✓	
	Orchestra ^{*5}	✓	✓	✓			
	Unplugged ^{*5}	✓	✓	✓			
	Studio-Mix ^{*5}	✓	✓	✓			
	AllChStereo	✓	✓	✓	✓	✓	✓
FullMono	✓	✓	✓	✓	✓	✓	
[GAME]	DolbyDigital	✓					
	DolbyDigital Plus				✓ ^{*2}		
	Neo:6	✓ ^{*4}			✓ ^{*4}		
	Dolby PLII Game/Dolby PLIIx Game ^{*3}		✓			✓	
	DolbyEX	✓ ^{*4}			✓ ^{*4}		
	AllChStereo	✓	✓	✓	✓	✓	✓
	FullMono	✓	✓	✓	✓	✓	✓
T-D	✓	✓	✓				
[STEREO]	AllChStereo	✓	✓	✓	✓	✓	✓
	Stereo	✓	✓	✓	✓	✓	✓

*1. North American model doesn't have Pure Audio listening mode.

*2. If there are no surround back speakers, depending on the input signal, Dolby Digital may be used.

*3. If there are no surround back speakers, or Powered Zone 2 is being used, Dolby Pro Logic II is used.

*4. Cannot be selected with some source formats.

*5. Available only when using surround speakers.

Requires 6.1/7.1 speakers. Not available while Powered Zone 2 is being used.

Requires 7.1 speakers. Not available while Powered Zone 2 is being used.

Note:

- With some HD DVD and Blu-ray discs, a noise may be heard during playback. This may occur when the audio format changes during playback. It is not a malfunction.

Using the Listening Modes—Continued

DTS Sources

Button	Source format	DTS, DTS 96/24			DTS Discrete/Matrix
		Multichannel	2ch	Mono	DVD, CD, etc.
	Media	DVD, CD, etc.			DVD, CD, etc.
[PURE AUDIO]	Pure Audio ^{*1}	✓	✓	✓	✓
[MOVIE/TV]	Mono	✓	✓	✓	✓
	DTS, DTS 96/24	✓			✓
	DTS-ES Discrete/Matrix				✓ ^{*2}
	Neo:6	✓ ^{*4}			
	Dolby PLII Movie/Dolby PLIIx Movie ^{*3}	✓ ^{*4}	✓		
	DolbyEX	✓ ^{*4}			
	Neo:6 Cinema		✓		
	MonoMovie ^{*5 *6}	✓	✓	✓	✓
	TV Logic ^{*5 *6}	✓	✓	✓	✓
	AllChStereo	✓	✓	✓	✓
	FullMono	✓	✓	✓	✓
T-D ^{*6}	✓	✓	✓	✓	
[MUSIC]	Pure Audio ^{*1}	✓	✓	✓	✓
	Direct	✓	✓	✓	✓
	Stereo	✓	✓	✓	✓
	DTS, DTS 96/24	✓			✓
	DTS-ES Discrete/Matrix				✓ ^{*2}
	Neo:6	✓ ^{*4}			
	Dolby PLII Music/Dolby PLIIx Music ^{*3}	✓ ^{*4}	✓		
	DolbyEX	✓ ^{*4}			
	Neo:6 Music		✓		
	Orchestra ^{*5 *6}	✓	✓	✓	✓
	Unplugged ^{*5 *6}	✓	✓	✓	✓
	Studio-Mix ^{*5 *6}	✓	✓	✓	✓
	AllChStereo	✓	✓	✓	✓
FullMono	✓	✓	✓	✓	
[GAME]	DTS, DTS 96/24	✓			✓
	DTS-ES Discrete/Matrix				✓ ^{*2}
	Neo:6	✓ ^{*4}			
	Dolby PLII Game/Dolby PLIIx Game ^{*3}		✓		
	DolbyEX	✓ ^{*4}			
	AllChStereo	✓	✓	✓	✓
	FullMono	✓	✓	✓	✓
T-D ^{*6}	✓	✓	✓	✓	
[STEREO]	AllChStereo	✓	✓	✓	✓
	Stereo	✓	✓	✓	✓

*1. North American model doesn't have Pure Audio listening mode.

*2. If there are no surround back speakers, or Zone 2 is being used, DTS is used.

*3. If there are no surround back speakers, or Powered Zone 2 is being used, Dolby Pro Logic II is used.

*4. Cannot be selected with some source formats.

*5. Available only when using surround speakers.

*6. DTS 96/24 is processed as DTS.

Requires 6.1/7.1 speakers. Not available while Powered Zone 2 is being used.

Requires 7.1 speakers. Not available while Powered Zone 2 is being used.

Using the Listening Modes—Continued

TrueHD Sources

Button	Source format	TrueHD			TrueHD 192kHz		
		Multichannel	2ch	Mono/ Multiplex	Multichannel	2ch	Mono/ Multiplex
	Media	Blu-ray, HD DVD			Blu-ray, HD DVD		
	Listening Mode	Blu-ray, HD DVD			Blu-ray, HD DVD		
[PURE AUDIO]	Pure Audio ^{*1}	✓	✓	✓	✓	✓	✓
[MOVIE/TV]	Mono	✓	✓	✓			
	TrueHD	✓			✓		
	Neo:6	✓ ^{*3}					
	Dolby PLII Movie/Dolby PLIIx Movie ^{*2}	✓ ^{*3}	✓				
	DolbyEX	✓ ^{*3}					
	Neo:6 Cinema		✓				
	AllChStereo	✓	✓	✓			
	FullMono	✓	✓	✓			
[MUSIC]	Pure Audio ^{*1}	✓	✓	✓	✓	✓	✓
	Direct	✓	✓	✓	✓	✓	✓
	Stereo	✓	✓	✓	✓	✓	✓
	TrueHD	✓			✓		
	Neo:6	✓ ^{*3}					
	Dolby PLII Music/Dolby PLIIx Music ^{*2}	✓ ^{*3}	✓				
	DolbyEX	✓ ^{*3}					
	Neo:6 Music		✓				
	AllChStereo	✓	✓	✓			
	FullMono	✓	✓	✓			
[GAME]	TrueHD	✓			✓		
	Neo:6	✓ ^{*3}					
	Dolby PLII Game/Dolby PLIIx Game ^{*2}		✓				
	DolbyEX	✓ ^{*3}					
	AllChStereo	✓	✓	✓			
	FullMono	✓	✓	✓			
[STEREO]	AllChStereo	✓	✓	✓			
	Stereo	✓	✓	✓	✓	✓	✓

*1. North American model doesn't have Pure Audio listening mode.

*2. If there are no surround back speakers, or Powered Zone 2 is being used, Dolby Pro Logic II is used.

*3. Cannot be selected with some source formats.

■ Requires 6.1/7.1 speakers. Not available while Powered Zone 2 is being used.

■ Requires 7.1 speakers. Not available while Powered Zone 2 is being used.

Note:

- With some HD DVD and Blu-ray discs, a noise may be heard during playback. This may occur when the audio format changes during playback. It is not a malfunction.

Using the Listening Modes—Continued

DTS-HD Sources

Button	Source format	DTS-HD High Resolution			DTS-HD Master Audio ^{*1}		
		Multichannel	2ch	Mono	Multichannel	2ch	Mono
Media	Listening Mode	Blu-ray, HD DVD			Blu-ray, HD DVD		
[PURE AUDIO]	Pure Audio ^{*2}	✓	✓	✓	✓	✓	✓
[MOVIE/TV]	Mono	✓	✓	✓	✓	✓	✓
	DTS-HD High Resolution	✓					
	DTS-HD Master Audio				✓		
	Neo:6	✓ ^{*4}			✓ ^{*4}		
	Dolby PLII Movie/Dolby PLIIx Movie ^{*3}	✓ ^{*4}	✓		✓ ^{*4}	✓	
	DolbyEX	✓ ^{*4}			✓ ^{*4}		
	Neo:6 Cinema		✓			✓	
	AllChStereo	✓	✓	✓	✓	✓	✓
FullMono	✓	✓	✓	✓	✓	✓	
[MUSIC]	Pure Audio ^{*2}	✓	✓	✓	✓	✓	✓
	Direct	✓	✓	✓	✓	✓	✓
	Stereo	✓	✓	✓	✓	✓	✓
	DTS-HD High Resolution	✓					
	DTS-HD Master Audio				✓		
	Neo:6	✓ ^{*4}			✓ ^{*4}		
	Dolby PLII Music/Dolby PLIIx Music ^{*3}	✓ ^{*4}	✓		✓ ^{*4}	✓	
	DolbyEX	✓ ^{*4}			✓ ^{*4}		
	Neo:6 Music		✓			✓	
	AllChStereo	✓	✓	✓	✓	✓	✓
	FullMono	✓	✓	✓	✓	✓	✓
[GAME]	DTS-HD High Resolution	✓					
	DTS-HD Master Audio				✓		
	Neo:6	✓ ^{*4}			✓ ^{*4}		
	Dolby PLII Game/Dolby PLIIx Game ^{*3}		✓			✓	
	DolbyEX	✓ ^{*4}			✓ ^{*4}		
	AllChStereo	✓	✓	✓	✓	✓	✓
	FullMono	✓	✓	✓	✓	✓	✓
[STEREO]	AllChStereo	✓	✓	✓	✓	✓	✓
	Stereo	✓	✓	✓	✓	✓	✓

*1. 192kHz DTS-HD Master Audio sources are processed at 96kHz.

*2. North American model doesn't have Pure Audio listening mode.

*3. If there are no surround back speakers, or Powered Zone 2 is being used, Dolby Pro Logic II is used.

*4. Cannot be selected with some source formats.

Requires 6.1/7.1 speakers. Not available while Powered Zone 2 is being used.

Requires 7.1 speakers. Not available while Powered Zone 2 is being used.

Note:

- With some HD DVD and Blu-ray discs, a noise may be heard during playback. This may occur when the audio format changes during playback. It is not a malfunction.

Using the Listening Modes—Continued

DTS Express and DSD Sources

Button	Source format	DTS Express			DSD ^{*1}	
		Multichannel	2ch	Mono	Multichannel (3/2.1)	2ch
	Media	Blu-ray, HD DVD			SACD	
Listening Mode						
[PURE AUDIO]	Pure Audio ^{*2}	✓	✓	✓	✓	✓
[MOVIE/TV]	Mono	✓	✓	✓	✓	✓
	DTS Express	✓				
	DSD				✓	
	Neo:6	✓ ^{*4}			✓	
	Dolby PLII Movie/Dolby PLIIx Movie ^{*3}	✓ ^{*4}	✓		✓	✓
	DolbyEX	✓ ^{*4}			✓	
	Neo:6 Cinema		✓			✓
	MonoMovie ^{*5}				✓	✓
	TV Logic ^{*5}				✓	✓
	AllChStereo	✓	✓	✓	✓	✓
	FullMono	✓	✓	✓	✓	✓
T-D					✓	
[MUSIC]	Pure Audio ^{*2}	✓	✓	✓	✓	✓
	Direct	✓	✓	✓	✓	✓
	Stereo	✓	✓	✓	✓	✓
	DTS Express	✓				
	DSD				✓	
	Neo:6	✓ ^{*4}			✓	
	Dolby PLII Music/Dolby PLIIx Music ^{*3}	✓ ^{*4}	✓		✓	✓
	DolbyEX	✓ ^{*4}			✓	
	Neo:6 Music		✓			✓
	Orchestra ^{*5}				✓	✓
	Unplugged ^{*5}				✓	✓
	Studio-Mix ^{*5}				✓	✓
	AllChStereo	✓	✓	✓	✓	✓
FullMono	✓	✓	✓	✓	✓	
[GAME]	DTS Express	✓				
	DSD				✓	
	Neo:6				✓	
	Dolby PLII Game/Dolby PLIIx Game ^{*3}		✓			✓
	DolbyEX				✓	
	AllChStereo	✓	✓	✓	✓	✓
	FullMono	✓	✓	✓	✓	✓
T-D					✓	
[STEREO]	AllChStereo	✓	✓	✓	✓	✓
	Stereo	✓	✓	✓	✓	✓

*1. DSD signals are processed after conversion to PCM.

*2. North American model doesn't have Pure Audio listening mode.

*3. If there are no surround back speakers, or Powered Zone 2 is being used, Dolby Pro Logic II is used.

*4. Cannot be selected with some source formats.

*5. Available only when using surround speakers.



If you can select PCM or DSD output on your SACD player, in some cases, selecting PCM will provide the best sound quality.

Note:

- With some HD DVD and Blu-ray discs, a noise may be heard during playback. This may occur when the audio format changes during playback. It is not a malfunction.

About the Listening Modes

The AV receiver's listening modes can transform your listening room into a movie theater or concert hall, with high fidelity and stunning surround sound.

The illustration shows which speakers are active in each listening mode with 7.1-channel speaker system.

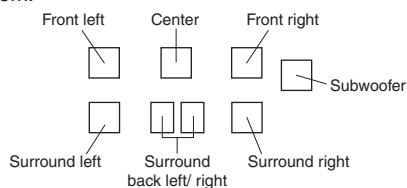

Pure Audio (not North American models)

In this mode, the display and video circuitry are turned off, minimizing possible noise sources for the ultimate in high-fidelity reproduction. (As the video circuitry is turned off, only the HDMI OUT outputs video.)

Direct

In this mode, audio from the input source is output directly with minimal processing, providing high-fidelity reproduction. All of the source's audio channels are output as they are.

Stereo ■ □ ■ ■

Sound is output by the front left and right speakers and subwoofer.

Mono ■ □ ■ ■

Use this mode when watching an old movie with a mono soundtrack, or use it with the foreign language soundtracks recorded in the left and right channels of some movies. It can also be used with DVDs or other sources containing multiplexed audio, such as karaoke DVDs.

Dolby Pro Logic IIx ■ ■ ■ ■ ■ ■ ■ ■

Dolby Pro Logic II ■ ■ ■ ■ ■ ■ ■ ■

Dolby Pro Logic IIx expands any 2-channel source for 7.1-channel playback. It provides a very natural and seamless surround-sound experience that fully envelops the listener. As well as music and movies, video games can also benefit from the dramatic spatial effects and vivid imaging. If you're not using any surround back speakers, **Dolby Pro Logic II** will be used instead of Dolby Pro Logic IIx.

- **Dolby PLIIx Movie**

Use this mode with any stereo or Dolby Surround (Pro Logic) movie (e.g., TV, DVD, VHS).

- **Dolby PLIIx Music**

Use this mode with any stereo or Dolby Surround (Pro Logic) music source (e.g., CD, radio, cassette, TV, VHS, DVD).

- **Dolby PLIIx Game**

Use this mode with video games, especially those that bear the Dolby Pro Logic II logo.

Dolby Digital ■ ■ ■ ■ ■ ■ ■ ■

Use this mode with DVDs that bear the Dolby Digital logo, and Dolby Digital TV broadcasts. This is the most common digital surround-sound format, and it'll put you right in the middle of the action, just like being in a movie theater or concert hall.

5.1-channel source + Dolby EX ■ ■ ■ ■ ■ ■ ■ ■

These modes expand 5.1-channel sources for 6.1/7.1-channel playback. They're especially suited to Dolby EX soundtracks that include a matrix-encoded surround back channel. The additional channel adds an extra dimension and provides an enveloping surround sound experience, perfect for rotating and fly-by sound effects.

5.1-channel source + Dolby PLIIx Music ■ ■ ■ ■ ■ ■ ■ ■

These modes use the Dolby Pro Logic IIx Music mode to expand 5.1-channel sources for 6.1/7.1-channel playback.

5.1-channel source + Dolby PLIIx Movie ■ ■ ■ ■ ■ ■ ■ ■

These modes use the Dolby Pro Logic IIx Movie mode to expand 5.1-channel sources for 7.1-channel playback.

Dolby Digital Plus ■ ■ ■ ■ ■ ■ ■ ■

Developed for use with HDTV, including the new video disc formats Blu-ray and HD DVD, this is the latest multichannel audio format from Dolby. It supports up to 7.1 channels with 48kHz sampling rate.

Dolby TrueHD ■ ■ ■ ■ ■ ■ ■ ■

Designed to take full advantage of the additional storage space offered by the new Blu-ray and HD DVD disc formats, this new Dolby format offers up to 7.1 discrete channels of digital audio with 48/96 kHz, up to 5.1-channels with 192 kHz sampling rate.

For the signals supported by the AV receiver, see page 61.

DTS ■ ■ ■ ■ ■ ■ ■ ■

The DTS digital surround-sound format supports up to 5.1 discrete channels and uses less compression for high-fidelity reproduction. Use it with DVDs and CDs that bear the DTS logo.

DTS 96/24 ■ ■ ■ ■ ■ ■ ■ ■

This mode is for use with DTS 96/24 sources. This is high-resolution DTS with a 96kHz sampling rate and 24-bit resolution, providing superior fidelity. Use it with DVDs that bear the DTS 96/24 logo.

DTS-ES Discrete

This mode is for use with DTS-ES Discrete soundtracks, that use a discrete surround back channel for true 6.1/7.1-channel playback. The seven totally separate audio channels provide better spatial imaging and 360-degree sound localization, perfect for sounds that pan across the surround channels. Use it with DVDs that bear the DTS-ES logo, especially those with a DTS-ES Discrete soundtrack.

DTS-ES Matrix

This mode is for use with DTS-ES Matrix soundtracks, that use a matrix-encoded back-channel for 6.1/7.1-channel playback. Use it with DVDs that bear the DTS-ES logo, especially those with a DTS-ES Matrix soundtrack.

DTS Neo:6

This mode expands any 2-channel source for 7.1-channel playback. It uses seven full-bandwidth channels of matrix decoding for matrix-encoded material, providing a very natural and seamless surround sound experience that fully envelops the listener.

- **Neo:6 Cinema**
Use this mode with any stereo movie (e.g., TV, DVD, VHS).
- **Neo:6 Music**
Use this mode with any stereo music source (e.g., CD, radio, cassette, TV, VHS, DVD).

5.1-channel source + Neo:6

This mode uses Neo:6 to expand 5.1-channel sources for 6.1/7.1-channel playback.

DTS-HD High Resolution Audio

Developed for use with HDTV, including the new video disc formats Blu-ray and HD DVD, this is the latest multichannel audio format from DTS. It supports up to 7.1 channels with 96 kHz sampling rate.

DTS-HD Master Audio

Designed to take full advantage of the additional storage space offered by the new Blu-ray and HD DVD disc formats, this new DTS format offers up to 7.1 discrete channels of digital audio with 48/96 kHz, up to 5.1-channels with 192 kHz sampling rate.

For the signals supported by the AV receiver, see page 62.

DTS Express

This format supports up to 5.1 channels and a lower sampling rate of 48 kHz. Applications include interactive audio and commentary encoding for HD DVD Sub Audio and Blu-ray Secondary Audio. Also broadcast and media servers.

DSD

DSD stands for Direct Stream Digital and is the format used to store digital audio on Super Audio CDs (SACD). This mode can be used with SACDs that feature multi-channel audio.

Onkyo Original DSP Modes

Mono Movie

This mode is suitable for old movies and other mono sources. The center speaker outputs the sound as it is, while reverb is applied to the sound output by the other speakers, giving presence to even mono material.

Orchestra

Suitable for classical or operatic music, this mode emphasizes the surround channels in order to widen the stereo image and simulates the natural reverberation of a large hall.

Unplugged

Suitable for acoustic instruments, vocals, and jazz, this mode emphasizes the front stereo image, giving the impression of being right in front of the stage.

Studio-Mix

Suitable for rock or pop music, listening to music in this mode creates a lively sound field with a powerful acoustic image, like being at a club or rock concert.

TV Logic

This mode adds realistic acoustics to TV shows produced in a TV studio, surround effects to the entire sound, and clarity to voices.

All Ch Stereo

Ideal for background music, this mode fills the entire listening area with stereo sound from the front, surround, and surround back speakers.

Full Mono

In this mode, all speakers output the same sound in mono, so the sound you hear is the same regardless of where you are within the listening room.

T-D (Theater-Dimensional) or

With this mode you can enjoy a virtual 5.1 surround sound even with only two or three speakers. This works by controlling how sounds reach the listener's left and right ears. Good results may not be possible if there's too much reverb, so we recommend that you use this mode in an environment with little or no natural reverb.

Recording

This section explains how to record the input source and how to record audio and video from separate sources.

Notes:

- The surround sound and DSP listening modes cannot be recorded.
- Copy-protected DVDs cannot be recorded.
- Sources connected to the analog multichannel input cannot be recorded.
- Sources connected to a digital input cannot be recorded. Only analog inputs can be recorded.
- DTS signals will be recorded as noise, so don't attempt analog recording of DTS CDs or LDs.
- While the Pure Audio listening mode is selected, the VCR/DVR OUT V and S jacks don't output video signals, so select another mode when recording.

Recording the Input Source

Audio sources can be recorded to a recorder (e.g., cassette deck, CDR, MD) connected to the TAPE OUT jack. Video sources can be recorded to a video recorder (e.g., VCR, DVR) connected to the VCR/DVR OUT jacks. See pages 20 to 36 for hookup information.

1

Remote controller

Use the input selector buttons to select the source that you want to record.

See “Which Connections Should I Use?” on page 21 to see which signals can be output and recorded.

You can watch the source while recording it. The AV receiver's MASTER VOLUME control has no effect on recording.

2

On your recorder, start recording.

3

On the source component, start playback.

Note:

- If you select a different input source during recording, that input source will be recorded instead.

Recording from Different AV Sources

You can overdub audio onto your video recordings by simultaneously recording audio and video from two separate sources. This is possible because only the audio source is switched when an audio-only input source, such as TAPE, TUNER, or CD, is selected, the video source remains the same.

In the following example, audio from the CD player connected to the CD IN and video from the camcorder connected to the AUX INPUT VIDEO jack are recorded by the VCR connected to the VCR/DVR OUT jacks.

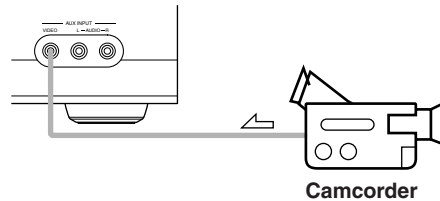

↖ : video signal
↙ : audio signal

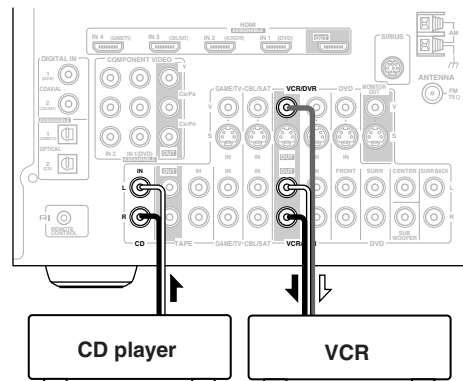



- 1** Prepare the camcorder and CD player for playback.
- 2** Prepare the VCR for recording.
- 3** Press the [AUX] input selector button.
- 4** Press the [CD] input selector button.
This selects the CD player as the audio source but leaves the camcorder as the video source.
- 5** Start recording on the VCR, then start playback on the camcorder and CD player.
Video from the camcorder and audio from the CD player are recorded by the VCR.

Adjusting the Listening Modes

Using the Audio Adjust Settings

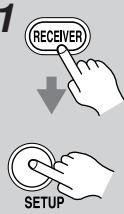
With the Audio Adjust functions and settings, you can adjust the sound and listening modes as you like.

- 

1 Press the [RECEIVER] REMOTE MODE button, followed by the [SETUP] button.
The main menu appears onscreen.
If the main menu doesn't appear, make sure the appropriate external input is selected on your TV.
- 

2 Use the Up and Down [▲]/[▼] buttons to select "3. Audio Adjust," and then press [ENTER].
- 

3 Use the Up and Down [▲]/[▼] buttons to select an item, and then press [ENTER].

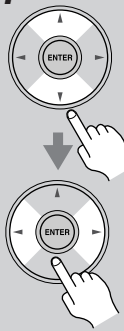
3. Audio Adjust	
1. Multiplex/Mono	
2. PLIIx/Neo:6	
3. Dolby EX	
4. Theater-Dimensional	
- 

4 Use the Up and Down [▲]/[▼] buttons to select an option, and use the Left and Right [◀]/[▶] buttons to change it.
The Audio Adjust menu items are explained below.
- 

5 When you've finished, press the [SETUP] button.
Setup closes.

The Audio Adjust settings are explained below.

Multiplex/Mono Settings

Multiplex

■ Input Ch

This setting determines which channel of a stereo multiplex source is output. Use it to select audio channels or languages with multiplex sources, multilingual TV broadcasts, and so on.

Main: The main channel is output (default).

Sub: The sub channel is output.

Main/Sub: Both the main and sub channels are output.

Mono

■ Input Ch

This setting determines which channel is output when the Mono listening mode is used with a stereo source.

Left+Right: Both the left and right channels are output (default).

Left: Only the left channel is output.

Right: Only the right channel is output.

PLIIx/Neo:6 Settings

PLIIx Music (2 ch Input)

These settings apply to only 2-channel stereo sources.

If you're not using any surround back speakers, these settings apply to Dolby Pro Logic II, not Dolby Pro Logic Ix.

■ Panorama

With this setting, you can broaden the width of the front stereo image when using the Dolby Pro Logic Ix Music listening mode.

On: Panorama function on.

Off: Panorama function off (default).

■ Dimension

With this setting, you can move the sound field forward or backward when using the Dolby Pro Logic Ix Music listening mode. It can be adjusted from -3 to +3. The default value is 0. Higher settings move the sound field backward. Lower settings move it forward.

If the stereo image feels too wide, or there's too much surround sound, move the sound field forward to improve the balance. Conversely, if the stereo image feels like it's in mono, or there's not enough surround sound, move it backward.

■ Center Width

With this setting, you can adjust the width of the sound from the center speaker when using the Dolby Pro Logic IIX Music listening mode. Normally, if you're using a center speaker, the center channel sound is output by only the center speaker. (If you're not using a center speaker, the center channel sound will be distributed to the front left and right speakers to create a phantom center). This setting controls the front left, right, and center mix, allowing you to adjust the weight of the center channel sound. It can be adjusted from 0 to 7. The default value is 3.

Neo:6 Music

■ Center Image

The DTS Neo:6 Music listening mode creates 6-channel surround sound from 2-channel stereo sources. With this setting, you can specify by how much the front left and right channel output is attenuated in order to create the center channel. It can be adjusted from 0 to 5. The default value is 2.

When set to 0, the front left and right channel output is attenuated by half (–6 dB), giving the impression that the sound is located centrally. This setting works well when the listening position is considerably off center. When set to 5, the front left and right channels are not attenuated, maintaining the original stereo balance.

Dolby EX Settings

■ Dolby EX

This setting determines how Dolby EX signals are handled.

Auto: When the source is Dolby EX, you can select the Dolby EX listening mode.

Manual: When the source is Dolby EX, you can select any of the listening modes compatible with this format (e.g., Dolby EX, Dolby Pro Logic IIX, etc.).

Theater-Dimensional Setting

■ Listening Angle

With this setting, you can optimize the Theater-Dimensional listening mode by specifying the angle of the front left and right speakers relative to the listening position. Ideally, the front left and right speakers should be equidistant from the listening position and at an angle close to one of the two available settings.

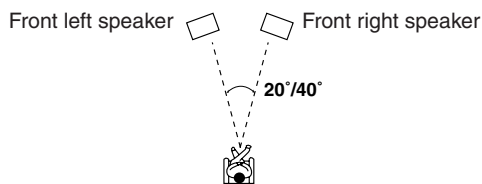

Narrow: Select if the listening angle is 20 degrees.



Wide: Select if the listening angle is 40 degrees (default).

Using the Audio Settings

You can change various audio settings by pressing the [AUDIO] button.

Note:

- When the Audio TV Out setting is set to On (page 81), the [AUDIO] button is disabled.

1 	Press the [RECEIVER] button followed by the [AUDIO] button.
2 	Use the Up and Down [▲]/[▼] buttons to select an item.
3 	Use the Left and Right [◀]/[▶] buttons to change the setting. Repeat this step for the other settings.

The Audio Adjust settings are explained below.

Tone Control Settings

You can adjust the bass and treble for the front speakers, except when the Direct or Pure Audio (not North American models) listening mode is selected.

■ Front Bass

You can boost or cut low-frequency sounds output by the front speakers from -10 dB to +10 dB in 2 dB steps.

■ Front Treble

You can boost or cut high-frequency sounds output by the front speakers from -10 dB to +10 dB in 2 dB steps.

Notes:

- To bypass the bass and treble tone circuits, select the Direct or Pure Audio (not North American model) listening mode.
- This procedure can also be performed on the AV receiver by using its [TONE], [-], and [+] buttons.

Late Night Function

■ Late Night

With the Late Night function, you can reduce the dynamic range of Dolby Digital material so that you can still hear quiet parts even when listening at low volume levels—ideal for watching movies late at night when you don't want to disturb anyone.

For **Dolby Digital** and **Dolby Digital Plus** sources, the options are:

Off: Late Night function off (default).

Low: Small reduction in dynamic range.

High: Large reduction in dynamic range.

For **Dolby TrueHD** sources, the options are:

Auto: The Late Night function is set to On or Off automatically (default).

Off: Late Night function off.

On: Late Night function on.

Notes:

- The Late Night function can be used only when the input source is Dolby Digital, Dolby Digital Plus, or Dolby TrueHD.
- The effect of the Late Night function depends on the material that you are playing and the intention of the original sound designer, and with some material there will be little or no effect when you select the different options.
- The Late Night function is set to Off when the AV receiver is set to Standby. For Dolby TrueHD sources, it will be set to Auto.

CinemaFILTER

■ Cinema Fltr

With the CinemaFILTER, you can soften overly bright movie soundtracks, which are typically mixed for reproduction in a movie theater.

CinemaFILTER can be used with the following listening modes: Dolby Digital, Dolby Digital EX, Dolby Pro Logic IIx Movie, Dolby Pro Logic II Movie, DTS, DTS-ES, DTS Neo:6 Cinema, DTS 96/24, and Neo:6.

Off: CinemaFILTER off.

On: CinemaFILTER on.

Note:

- The CinemaFILTER may not work when used with certain input sources.

Audyssey Dynamic EQ®

■ **DynamicEQ**

With Audyssey Dynamic EQ, you can enjoy great sound even when listening at low volume levels.

Audyssey Dynamic EQ solves the problem of deteriorating sound quality as volume is decreased by taking into account human perception and room acoustics.

It does so by selecting the correct frequency response and surround volume levels moment-by-moment so that the content sounds the way it was created at any volume level—not just at reference level.

Off: Audyssey Dynamic EQ off.

On: Audyssey Dynamic EQ on.

Note:

- Audyssey Dynamic EQ can be set only when the Equalizer Settings on page 76 are set to Audyssey.

Music Optimizer

■ **M.Optimizer**

The Music Optimizer function enhances the sound quality of compressed music files. Use it with music files that use “lossy” compression, such as MP3.

Off: Music Optimizer off (default).

On: Music Optimizer on.

Note:

- The Music Optimizer function only works with PCM digital audio input signals with a sampling rate below 48kHz and analog audio input signals. The Music Optimizer is disabled when the Pure Audio or Direct listening mode is selected.

Speaker Levels

You can adjust the volume of each speaker while listening to an input source.

These temporary adjustments are cancelled when the AV receiver is set to Standby.

■ **Subwoofer**

You can adjust the level from –15 dB to +12 dB.

■ **Center**

You can adjust the level from –12 dB to +12 dB.

Notes:

- You cannot use this function while the AV receiver is muted.
- Speakers that are set to No or None in the Speaker Configuration cannot be adjusted (see page 72).
- This setting is not available when the Pure Audio listening mode is used, or the Direct listening mode is used with an analog input signal.

A/V Sync

■ **A/V Sync**

When using progressive scanning on your DVD player, you may find that the picture and sound are out of sync. With this setting, you can correct this by delaying the audio signals. You can set it from 0 to 100 milliseconds (ms) in 10 millisecond steps.

Listening Mode Presets

On the Listening Mode Preset menu, you can specify a default listening mode for each of the audio formats supported by each input selector. The AV receiver will then select the listening mode automatically depending on the format of the input signal. You can still select the other listening modes, although the default listening mode will be used the next time you turn on the AV receiver.

- 1**

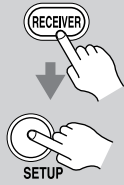

Press the [RECEIVER] REMOTE MODE button, followed by the [SETUP] button.

The main menu appears onscreen. If the main menu doesn't appear, make sure the appropriate external input is selected on your TV.
- 2**



Use the Up and Down [▲]/[▼] buttons to select "5. Listening Mode Preset," and then press [ENTER].
- 3**



Use the Up and Down [▲]/[▼] buttons to select an input selector, and then press [ENTER].

The audio formats supported by that input selector appear.

For the TUNER input selector, Analog is the only format available.

4

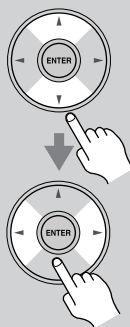

Use the Up and Down [▲]/[▼] buttons to select an audio format, and use the Left and Right [◀]/[▶] buttons to select a listening mode.

Only listening modes compatible with the audio format can be selected (see pages 58–63).

Analog/PCM: Specifies the default listening mode for analog and PCM sources.

Dolby Digital: Specifies the default listening mode for Dolby Digital sources.

DTS: Specifies the default listening mode for DTS sources.

D.F. 2ch: Specifies the default listening mode for 2-channel (2/0) stereo sources in a digital format, such as Dolby Digital or DTS.

D.F. Mono: Specifies the default listening mode for mono sources in a digital format, such as Dolby Digital or DTS.

Multich PCM: Specifies the default listening mode for multichannel PCM sources, such as DVD-Audio (input via HDMI).

192k/176.4k: Specifies the default listening mode for high resolution 192kHz and 176.4kHz digital sources, such as DVD-Audio.

Dolby TrueHD: Specifies the default listening mode for Dolby TrueHD sources, such as Blu-ray or HD DVD (input via HDMI).

DTS-HD Master Audio: Specifies the default listening mode for DTS-HD Master Audio sources, such as Blu-ray or HD DVD (input via HDMI).

DSD: Specifies the default listening mode for DSD multichannel sources, such as SACD.

5



When you've finished, press the [SETUP] button.

Setup closes.

Note:

- This procedure can also be performed on the AV receiver by using its [SETUP], [ENTER], and arrow buttons.

Advanced Setup

Speaker Setup

This section explains how to check the speaker settings and how to set them manually, which is useful if you change a speaker after performing the automatic speaker setup.

Some of the speaker settings are set automatically by the Automatic Speaker Setup function (see page 38).



Speaker Configuration



This setting is set automatically by the Automatic Speaker Setup function (see page 38).

With the Speaker Configuration settings, you can specify which speakers are connected and a crossover frequency, distance, and level for each speaker.

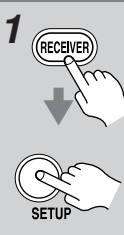
The following crossover frequencies can be specified: Full Band, 40Hz, 50Hz, 60Hz, 80Hz, 100Hz, 120Hz, 150Hz, or 200Hz.

Specify Full Band for speakers that can output low-frequency bass sounds adequately, for example, speakers with a good sized woofer. For smaller speakers, specify a crossover frequency. Sounds below the crossover frequency will then be output by the subwoofer instead of the speaker. Refer to your speakers' manuals to determine the optimum crossover frequencies.

 <p>1 Press the [RECEIVER] button followed by the [SETUP] button. The main menu appears onscreen. If the main menu doesn't appear, make sure the appropriate external input is selected on your TV.</p>	
 <p>2 Use the Up and Down [▲]/[▼] buttons to select "2. Speaker Setup," and then press the [ENTER] button.</p>	

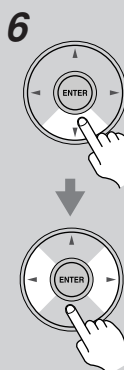
 <p>3 Use the Up and Down [▲]/[▼] buttons to select "2. Speaker Configuration," and then press the [ENTER] button.</p>	
 <p>4 While the "Subwoofer" setting is selected, use the Left and Right [◀]/[▶] buttons to select Yes or No.</p> <p>Yes: Select if a subwoofer is connected.</p> <p>No: Select if no subwoofer is connected.</p>	
 <p>5 Use the Down [▼] button to select "Front," and then use the Left and Right [◀]/[▶] buttons to select a crossover frequency.</p> <p>Note:</p> <ul style="list-style-type: none">Fixed at Full Band if Subwoofer (step 4) is set to No.	
 <p>6 Use the Down [▼] button to select "Center," and then use the Left and Right [◀]/[▶] buttons to select a crossover frequency.</p> <p>If no center speaker is connected, select None.</p> <p>Note:</p> <ul style="list-style-type: none">Cannot select Full Band if Front (step 5) is set to anything other than Full Band.	

7



Use the Down [▼] button to select “Surround,” and then use the Left and Right [◀]/[▶] buttons to select a crossover frequency.

If no surround left and right speakers are connected, select None.

Note:

- Cannot select Full Band if Front (step 5) is set to anything other than Full Band.

8



Use the Down [▼] button to select “Surr Back,” and use the Left and Right [◀]/[▶] buttons to select a crossover frequency.

If no surround back speakers are connected, select None.

Notes:

- If the Surround setting in step 7 is set to None, or Powered Zone 2 is being used, this setting does not appear.
- Cannot select Full Band if Surround (step 7) is set to anything other than Full Band.

9

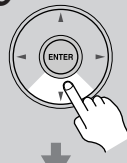

Use the Down [▼] button to select “Surr Back Ch,” and use the Left and Right [◀]/[▶] buttons to select 2ch or 1ch.

2ch: Select if two (left and right) surround back speakers are connected.

1ch: Select if one surround back speaker is connected.

Note:

- If the Surround or SurrBack settings in steps 7 and 8 are set to None, this setting does not appear.

Continue with step 10 of the “Low-Pass Filter for the LFE Channel” setting.

Note:

- These settings cannot be changed while headphones are connected or the multichannel DVD input is being used.

Low-Pass Filter for the LFE Channel

This setting is **not** set automatically by the Automatic Speaker Setup function (see page 38).

With this setting, you can specify the cutoff frequency of the LFE channel’s low-pass filter (LPF), which can be used to filter out unwanted hum. The LPF only applies to sources that use the LFE channel.

10



Use the Down [▼] button to select “LPF of LFE,” and then use the Left and Right [◀]/[▶] buttons to select a lowpass filter frequency.

The following low-pass filter frequencies can be selected: 80Hz, 90Hz, 100Hz, or 120Hz.



Continue with step 11 of the “Double Bass” setting on the next page.

Double Bass

This setting is **not** set automatically by the Automatic Speaker Setup function (see page 38).

With the Double Bass function, you can boost bass output by feeding bass sounds from the front left, right, and center channels to the subwoofer. This function can be set only if the Subwoofer setting (step 3) is set to Yes, and the Front setting (step 4) is set to Full Band in the Speaker Configuration on page 72.

11	<p>Use the Down [▼] button to select “Double Bass,” and then use the Left and Right [◀]/[▶] buttons to select:</p> <p>On: Double Bass function on. Bass from the front left and right channels is also fed to the subwoofer (default).</p> <p>Off: Double Bass function off.</p>
12	<p>Press the [SETUP] button. Setup closes.</p>

Note:



- These settings cannot be changed while headphones are connected or the multichannel DVD input is being used.

Speaker Distance

These settings are set automatically by the Automatic Speaker Setup function (see page 38).

With these settings, you can specify the distance from each speaker to the listening position.

1	<p>Measure and make a note of the distance from each speaker to the listening position.</p>
2	<p>Press the [RECEIVER] REMOTE MODE button, followed by the [SETUP] button.</p> <p>The main menu appears onscreen. If the main menu doesn't appear, make sure the appropriate external input is selected on your TV.</p>
3	<p>Use the Up and Down [▲]/[▼] buttons to select “2. Speaker Setup,” and then press the [ENTER] button.</p>
4	<p>Use the Up and Down [▲]/[▼] buttons to select “3. Speaker Distance,” and then press [ENTER].</p>
5	<p>While “Unit” is displayed, use the Left and Right [◀]/[▶] buttons to select “feet” or “meters”.</p> <p>feet: Distances can be set in feet. Range: 1 to 30 feet in 1-foot steps.</p> <p>meters: Distances can be set in meters. Range: 0.3 to 9 meters in 0.3-meter steps.</p>

6	 <p>Use the Down [▼] button to select “Left”, and use the Left and Right [◀]/[▶] buttons to specify the distance for the front speakers, then press the Down [▼] button to select the next speaker.</p>
7	<p>Repeat step 6 for all speakers.</p> <p>Note: Speakers that you set to No or None in the Speaker Configuration (page 72) cannot be selected.</p>
8	 <p>Press the [SETUP] button. Setup closes.</p>

Notes:

- The Center and Subwoofer distances can be set up to 5 ft. (1.5 m) more or less than the Left distance. For example, if the Left distance is set to 20 ft. (6 m), the Center and Subwoofer distances can be set between 15 and 25 ft. (4.5 and 7.5 m).
- The Surround and Surround Back distances can be set up to 5 ft. (1.5 m) more or 15 ft. (4.5 m) less than the Left distance. For example, if the Left distance is set to 20 ft. (6 m), the SurrRight, Surr Left, Surr Back R, and Surr Back L distances can be set between 5 and 25 ft. (1.5 and 7.5 m).
- The speaker distance cannot be adjusted while a pair of headphones is connected or the multichannel DVD input is being used.

Speaker Levels





These settings are set automatically by the Automatic Speaker Setup function (see page 38).

You can set the volume level of each speaker so that all speakers can be heard equally at the listening position.

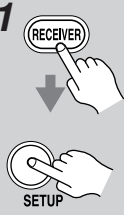
Note:

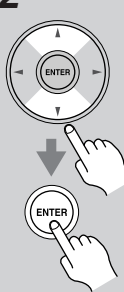
- The speaker levels cannot be adjusted while a pair of headphones is connected or the AV receiver is muted.

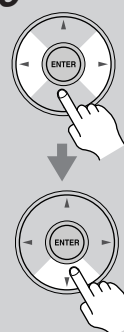
1	 <p>Press the [RECEIVER] REMOTE MODE button, followed by the [SETUP] button. The main menu appears onscreen. If the main menu doesn't appear, make sure the appropriate external input is selected on your TV.</p>
----------	---

2	 <p>Use the Up and Down [▲]/[▼] buttons to select “2. Speaker Setup,” and then press the [ENTER] button.</p>
3	 <p>Use the Up and Down [▲]/[▼] buttons to select “4. Level Calibration,” and then press [ENTER]. A pink noise test tone is output by the front left speaker.</p>
4	<p>Turn up the volume so that you can hear the test tone sufficiently. As each speaker outputs the test tone, its name appears on the display.</p>
5	 <p>Use the Left and Right [◀]/[▶] buttons to adjust the speaker level, and use the Down [▼] button to select the next speaker. The levels can be adjusted from –12 to +12 dB in 1 dB steps (–15 to +12 dB for the subwoofer).</p>
6	<p>Repeat step 5 so that the level of the test tone coming from each speaker is the same. Speakers that you set to No or None in the Speaker Configuration (page 72) do not output the test tone.</p>
7	 <p>Press the [SETUP] button. Setup closes. Don't forget to turn down the volume if you turned it up while setting the levels.</p>

Equalizer Settings

These settings are set automatically by the Automatic Speaker Setup function (see page 38).

Here you can adjust the tone of individual speakers. To set the volume of individual speakers, see page 75.

1 Press the [RECEIVER] REMOTE MODE button, followed by the [SETUP] button.



The main menu appears onscreen. If the main menu doesn't appear, make sure the appropriate external input is selected on your TV.

2 Use the Up and Down [▲]/[▼] buttons to select "2. Speaker Setup," and then press the [ENTER] button.

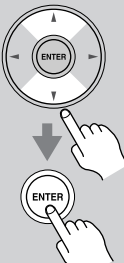

3 Use the Up and Down [▲]/[▼] buttons to select "5. Equalizer Settings," and then press [ENTER].



4 Use the Left and Right [◀]/[▶] buttons to select:

Off: Tone off, response flat.

Audyssey: The tone for each speaker is set automatically by the Automatic Speaker Setup function. Be sure to select this setting after having performed the Automatic Speaker Setup.

Manual: You can adjust the equalizer for each speaker manually.

If you selected Manual, continue with this procedure. If you selected Off or Audyssey, go to step 8.



5 Press the Down [▼] button, and then use the Left and Right [◀]/[▶] buttons to select a speaker.



Equalizer Channel	Manual	Front
63Hz	◀	0dB
250Hz		0dB
1000Hz		0dB
4000Hz		0dB
16000Hz		0dB

6 Use the Up and Down [▲]/[▼] buttons to select a frequency. Use the Left and Right [◀]/[▶] buttons to adjust the level at that frequency.



The volume at each frequency can be adjusted from -6 to +6 dB in 1 dB steps.

Tip: Low frequencies (e.g., 63Hz) affect bass sounds; high frequencies (e.g., 16000Hz) affect treble sounds.

7 Use the Up [▲] button to select "Channel," and then use the Left and Right [◀]/[▶] buttons to select another speaker.

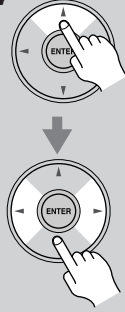

Repeat steps 5 and 6 for each speaker. Speakers that you've set to No or None in the Speaker Configuration (page 72) cannot be selected.

8 Press the [SETUP] button. The setup menu closes.



Notes:

- The front, center, surround, and surround back speakers can be adjusted at 63Hz, 250Hz, 1000Hz, 4000Hz, and 16000Hz. The subwoofer can be adjusted at 25Hz, 40Hz, 63Hz, 100Hz, and 160Hz.
- While the Direct or Pure Audio listening mode is selected, the equalizer settings have no effect.
- This procedure can also be performed on the AV receiver by using its [SETUP], [ENTER], and arrow buttons.

Source Setup

This section explains items on the Source Setup menu. Items can be set individually for each input selector.

1 Press the input selector buttons to select an input source, and then press the [RECEIVER] REMOTE MODE button.

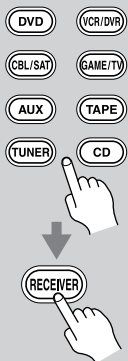

2 Press the [SETUP] button. The main menu appears onscreen. If the main menu doesn't appear, make sure the appropriate external input is selected on your TV.



3 Use the Up and Down [▲]/[▼] buttons to select "4. Source Setup," and then press [ENTER].



4 Use the Up and Down [▲]/[▼] buttons to select an item, and then press [ENTER].



5 Use the Left and Right [◀]/[▶] buttons to change it. The Source Setup menu items are explained below.



6

When you've finished, press the [SETUP] button. Setup closes.



IntelliVolume

With IntelliVolume, you can set the input level for each input selector individually. This is useful if one of your source components is louder or quieter than the others.

Use the Left and Right [◀]/[▶] buttons to set the level.

If a component is noticeably louder than the others, use the Left [◀] button to reduce its input level. If it's noticeably quieter, use the Right [▶] button to increase its input level. The input level can be adjusted from -12 dB to +12 dB in 1 dB steps.

Note:

- IntelliVolume does not apply for Zone 2.

A/V Sync

When using your DVD player's progressive scanning function, you may find that the picture and sound are out of sync. With the A/V Sync setting, you can correct this by applying a delay to the audio signal. The delay can be set from 0 to 100 milliseconds (msec) in 10 millisecond steps.

Use the Left and Right [◀]/[▶] buttons to set the delay.

To view the TV picture while setting the delay, press [ENTER].





If HDMI Lip Sync is enabled (see page 81), and your TV or display supports HDMI Lip Sync, the displayed delay time will be the A/V Sync delay time. The HDMI Lip Sync delay time is displayed underneath in parentheses.

Note:

- A/V Sync is disabled when the Pure Audio listening mode is selected, or when the Direct listening mode is used with an analog input source.

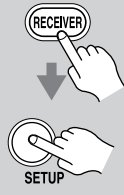
Miscellaneous Setup

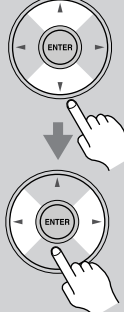
This section explains items on the Miscellaneous menu.

<p>1</p> 	<p>Press the [RECEIVER] REMOTE MODE button, followed by the [SETUP] button.</p> <p>The main menu appears onscreen. If the main menu doesn't appear, make sure the appropriate external input is selected on your TV.</p>
<p>2</p> 	<p>Use the Up and Down [▲]/[▼] buttons to select "6. Miscellaneous," and then press [ENTER].</p>
<p>3</p> 	<p>Use the Up and Down [▲]/[▼] buttons to select an item, and then press [ENTER].</p>
<p>4</p> 	<p>Use the Up and Down [▲]/[▼] buttons to select an item, and use the Left and Right [◀]/[▶] buttons to change it.</p> <p>The items are explained below.</p>
<p>5</p> 	<p>When you've finished, press the [SETUP] button.</p> <p>Setup closes.</p>

Note:

- This procedure can also be performed on the AV receiver by using its [SETUP], [ENTER], and arrow buttons.

Volume Setup

■ Maximum Volume

With this setting, you can limit the maximum volume. The Maximum Volume range is Off, 79 to 30.

■ Power On Volume

This setting determines what the volume will be each time the AV receiver is turned on.

The range is Last, Min, 1 to 79, Max.

To use the same volume level as when the AV receiver was last turned off, select Last.

Note:

- The Power On Volume setting cannot be set higher than the Maximum Volume setting.

■ Headphone Level

With this setting, you can offset the headphone volume relative to the main volume. This is useful if your headphones are too loud or too quiet at the volume setting you usually use when listening through your speakers. The headphone level can be set from -12 dB to +12 dB.

OSD Setup

■ Immediate Display

This setting determines whether operation details are displayed onscreen immediately after an AV receiver function is used.

On: Displayed (default).

Off: Not displayed.

Even if On is selected, operation details are not output if the input source is connected to an HDMI IN and output by the HDMI OUT.

■ Monitor Type

With this setting, you can specify the aspect ratio of your TV so that menus are displayed properly.

16:9: Select if your TV is 16:9 (default).

4:3: Select if your TV is 4:3.

■ Display Position

This setting determines where on the screen operation details are displayed.

Bottom: Bottom of the screen (default).

Top: Top of the screen.

■ TV format

For the onscreen setup menus to display properly, you must specify the TV system used in your area.

Auto: Select this to have the AV receiver automatically detect the TV system from the video input signals.

NTSC: Select if the TV system in your area is NTSC.

PAL: Select if the TV system in your area is PAL.

Hardware Setup

This section explains items on the Hardware menu.

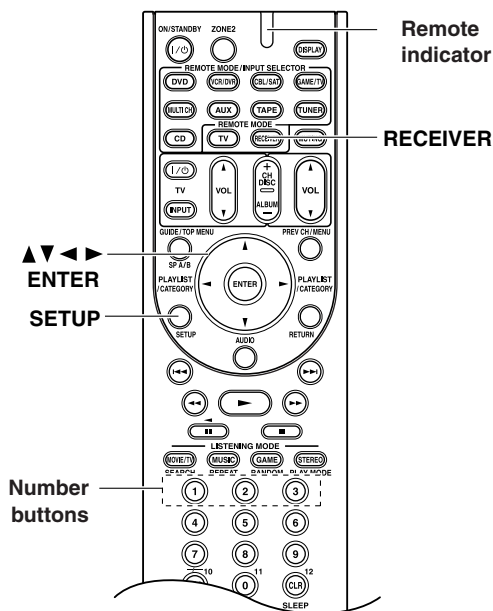

1 Press the [RECEIVER] REMOTE MODE button, followed by the [SETUP] button.

The main menu appears onscreen. If the main menu doesn't appear, make sure the appropriate external input is selected on your TV.

2 Use the Up and Down [▲]/[▼] buttons to select "7. Hardware Setup," and then press [ENTER].

3 Use the Up and Down [▲]/[▼] buttons to select an item, and then press [ENTER].

The screen for that item appears.

4 Use the Up and Down [▲]/[▼] buttons to select an item, and use the Left and Right [◀]/[▶] buttons to change it.

The items are explained below.

5 When you've finished, press the [SETUP] button.

Setup closes.

Note:

- This procedure can also be performed on the AV receiver by using its [SETUP], [ENTER], and arrow buttons.

Remote Control

■ Remote ID

When several Onkyo components are used in the same room, their remote ID codes may overlap. To differentiate the AV receiver from the other components, you can change its remote ID from 1, the default, to 2 or 3.

Note:

- If you do change the AV receiver's remote ID, be sure to change the remote controller to the same ID (see below), otherwise, you won't be able to control it with the remote controller.

Changing the Remote Controller's ID

1 While holding down the [RECEIVER] REMOTE MODE button, press and hold down the [SETUP] button until the Remote indicator lights up (about 3 seconds).

2

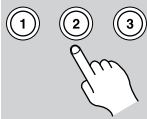

Use the number buttons to enter ID 1, 2, or 3.

The Remote indicator flashes twice.

Zone 2

See “Zone 2” on page 83.

Tuner

■ AM Frequency (on some models)

See “AM Frequency Step Setup (on some models)” on page 51.

■ SAT Radio Mode (on North American model)

If you connect a SIRIUS Satellite Radio antenna to the AV receiver, set this setting to SIRIUS. Otherwise, select None. See the separate Satellite Radio Guide for more information.

■ Antenna Aiming (on North American model)

The ID of the Sirius Connect Home Tuner is displayed here. You must sign up to obtain a SIRIUS ID. See the separate Satellite Radio Guide for more information.

■ SIRIUS Parental Lock (on North American model)

This item is for use with SIRIUS Satellite Radio. It’s not available if SAT Radio Mode is set to None. See the separate Satellite Radio Guide for more information.

Analog Multich

■ Subwoofer Input Sensitivity

Some DVD players output the LFE channel from their analog subwoofer output at 15 dB higher than normal. With this setting, you can change the AV receiver’s subwoofer sensitivity to match your DVD player. Note that this setting only affects signals connected to the AV receiver’s MULTI CH SUBWOOFER jack.

You can select 0dB, 5dB, 10dB, or 15dB.

If you find that your subwoofer is too loud, try the 10 dB or 15 dB setting.

HDMI

■ Output Resolution

You can specify the output resolution for the HDMI outputs and have the AV receiver upconvert the picture resolution as necessary to match the resolution supported by your TV.

See the “Video Resolution Chart” on page 102 to see how the AV receiver handles video input at different resolutions.

Through: Select this to pass video through the AV receiver at the same resolution and with no conversion.

Auto: Select this to have the AV receiver automatically convert video at resolutions not supported by your TV.

480p (480p/576p):

Select this for 480p or 576p output and video conversion as necessary.

720p: Select this for 720p output and video conversion as necessary.

1080i: Select this for 1080i output and video conversion as necessary.

■ Zoom Mode

This setting determines the aspect ratio that will be used for 480i, 480p, 576i, and 576p input signals when they are output by the HDMI OUT. This setting only applies when the HDMI Output Resolution setting is set to 1080i or 720p.

Normal:

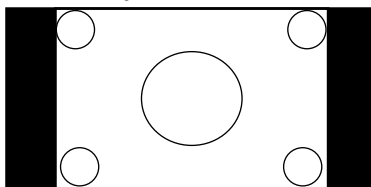
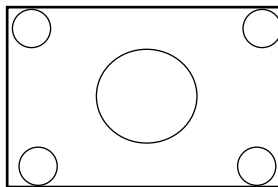

Full:

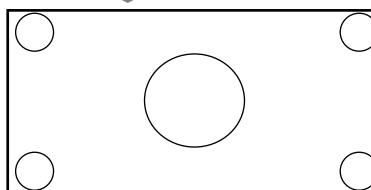
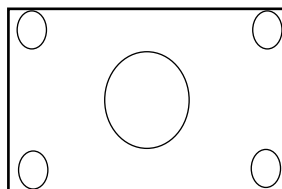

■ Audio TV Out

This setting determines whether audio received by an HDMI input is output by the HDMI outputs. You may want to change this setting to On if your TV is connected to an HDMI output and you want to listen to audio from an HDMI component through your TV's speakers. Normally, it should be set to Off.

Off: HDMI audio is not output (default).

On: HDMI audio is output.

Notes:

- If On is selected and the signal can be output by the TV, the AV receiver will output no sound through its speakers.
- When TV Control is enabled, this setting is set to Auto.
- With some TVs and input signals, no sound may be output even if On is selected.
- When the Audio TV Out setting is set to On, or TV Control is set to Enable and you're listening through your TV's speakers (see page 31), if you turn up the AV receiver's volume control, the sound will be output by the AV receiver's speakers. To stop the AV receiver's speakers producing sound, change the settings, change your TV's settings, or turn down the AV receiver's volume.

■ Lip Sync

The Lip Sync function can automatically synchronize HDMI audio and video that's gotten out of sync due to the complex digital video processing being performed by your HDMI-compatible TV. With HDMI Lip Sync, the audio delay required to synchronize the audio and video is calculated and applied automatically by the AV receiver.

Disable: HDMI lip sync disabled.

Enable: HDMI lip sync enabled.

Notes:

- This function works only if your HDMI-compatible TV supports HDMI Lip Sync.
- You can check the amount of delay being applied by the HDMI Lip Sync function on the A/V Sync screen (see page 77).

■ x.v.Color

If your HDMI source and HDMI-compatible TV both support the "x.v.Color," you can enable "x.v.Color" on the AV receiver with this setting.

Disable: "x.v.Color" disabled.

Enable: "x.v.Color" enabled.

■ Control

This function allows RIHD-compatible components connected via HDMI to be controlled with the AV receiver.

Disable: RIHD disabled.

Enable: RIHD enabled.

Notes:

- RIHD, which stands for Remote Interactive over HDMI, is the name of the system control function found on Onkyo components. The AV receiver can be used with CEC (Consumer Electronics Control), which allows system control over HDMI and is part of the HDMI standard. CEC provides interoperability between various components, however, operation with components other than RIHD-compatible components and recommended components cannot be guaranteed.
- Select Disable if a connected component is incompatible or you're not sure about its compatibility.
- If operation is unreliable when set to Enable, select Disable instead.

Power Control

To link the power functions of RIHD-compatible components connected via HDMI, select Enable.

Disable: Power Control disabled.

Enable: Power Control enabled.

Notes:

- The Power Control setting can be set only when the above Control setting is set to Enable.
- HDMI power control only works with RIHD-compatible components that support it and may not work properly with some components due to their settings or compatibility.
- When set to Enable, the AV receiver consumes more power.
- When set to Enable, the AV receiver enters Ready mode when set to Standby, and the STANDBY indicator lights up.
- When set to Enable, regardless of whether the AV receiver is On or on Standby, both audio and video received by an HDMI input will be output by the HDMI OUT for playback on the TV or other component that's connected to the HDMI OUT.

Advanced Setup—Continued

TV Control

Select Enable to control the AV receiver from an RIHD-compatible TV connected via HDMI.

Disable: TV Control disabled.

Enable: TV Control enabled.

Notes:





- Select Disable if your TV is incompatible or you're not sure about its compatibility.
- The TV Control setting can be set only when the above Control and Power Control settings are both set to Enable.
- When the Audio TV Out setting is set to On, or TV Control is set to Enable and you're listening through your TV's speakers (see page 31), if you turn up the AV receiver's volume control, the sound will be output by the AV receiver's speakers. To stop the AV receiver's speakers producing sound, change the settings, change your TV's settings, or turn down the AV receiver's volume.

Note:

- After changing the Control, Power Control, or TV Control setting, be sure to turn all of your components off and then back on again. Refer to the instruction manuals for your other components.

Lock Setup

With this setting, you can protect your settings by locking the setup menus.

1 	Press the [RECEIVER] button, followed by the [SETUP] button. The main menu appears onscreen. If the main menu doesn't appear, make sure the appropriate external input is selected on your TV.
2 	Use the Up and Down [▲]/[▼] buttons to select "8. Lock Setup," and then press [ENTER].
3 	Use the Left and Right [◀]/[▶] buttons to select: Locked: Setup menus locked. Unlocked: Setup menus unlocked. When Locked is selected, only this Lock Setup item can be accessed.
4 	Press the [SETUP] button. Setup closes.

Zone 2

In addition to your main listening room, you can also enjoy playback in the other room, or as we call Zone 2. And, you can select a different source for each room.

Connecting Zone 2

There are two ways you can connect Zone 2 speakers:

1. Connect them directly to the AV receiver.
2. Connect them to an amp in Zone 2.

Connecting Your Zone 2 Speakers Directly to the AV receiver

This setup allows 5.1-channel playback in your main room and 2-channel stereo playback in Zone 2, with a different source in each room. This is called Powered Zone 2, as the Zone 2 speakers are powered by the AV receiver. Note that when Powered Zone 2 is turned off, you can enjoy 7.1-channel playback in your main room.

To use this setup, you must set the Powered Zone 2 setting to Act (see page 84).

Hookup

- Connect your Zone 2 speakers to the AV receiver's ZONE 2 SPEAKERS L/R speaker terminals.

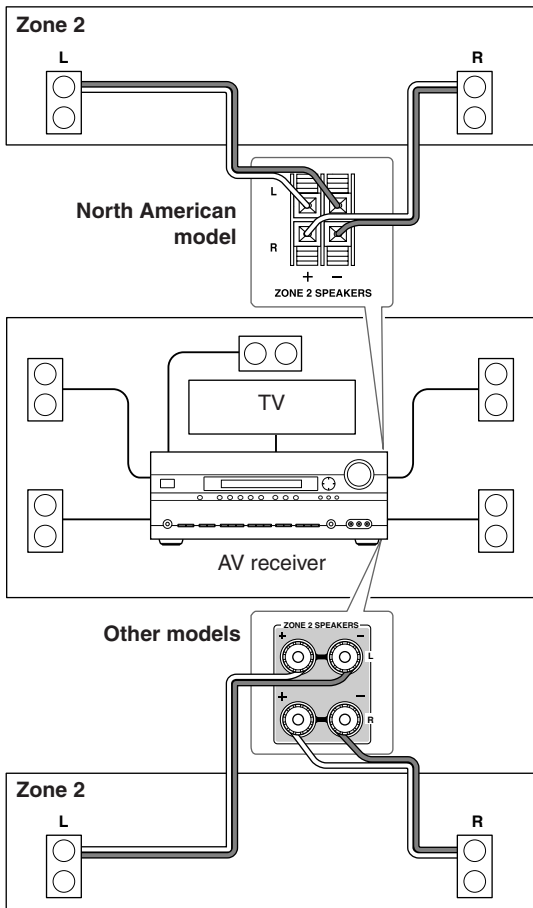

Notes:

- With this setup, the Zone 2 volume is controlled by the AV receiver.
- Powered Zone 2 cannot be used if Speaker Type is set to Bi-Amp (page 42).

Connecting Your Zone 2 Speakers to an Amp in Zone 2

This setup allows 7.1-channel playback in your main listening room and 2-channel stereo playback in Zone 2, with a different source in each room.

Hookup

- Use an RCA audio cable to connect the AV receiver's ZONE 2 LINE OUT L/R jacks to an analog audio input on your Zone 2 amp.
- Connect your Zone 2 speakers to the speaker terminals on your Zone 2 amp.

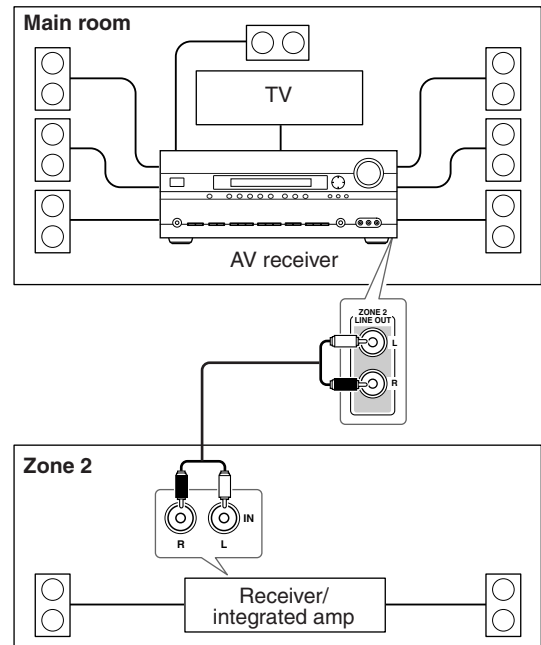

Note:

- The Zone 2 volume must be set on the Zone 2 amp.

Powered Zone 2 Setting

If you've connected your Zone 2 speakers to the AV receiver, as explained in "Connecting Your Zone 2 Speakers Directly to the AV receiver" on page 83, you must set the Powered Zone 2 setting to Act (Activated).

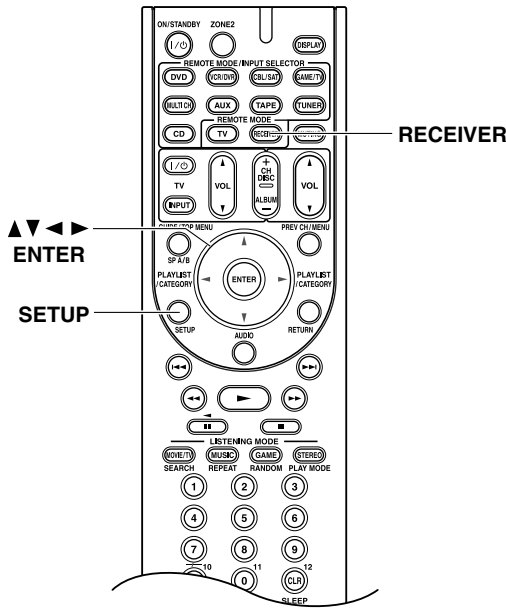

1 Press the [RECEIVER] REMOTE MODE button, followed by the [SETUP] button. The main menu appears onscreen. If the main menu doesn't appear, make sure the appropriate external input is selected on your TV.



2 Use the Up and Down [▲]/[▼] buttons to select "7. Hardware-Setup," and then press [ENTER].



3 Use the Up and Down [▲]/[▼] buttons to select "2.Zone2," and then press [ENTER].

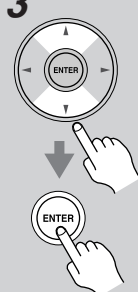

4 Use the Left and Right [◀]/[▶] buttons to select:

7-2. Zone2

Powered Zone2	◀ Not Act ▶
---------------	-------------

NotAct: ZONE 2 SPEAKERS L/R speaker terminals not activated (Powered Zone 2 disabled).
Act: ZONE 2 SPEAKERS L/R speaker terminals activated (Powered Zone 2 enabled).



5 Press the [SETUP] button. Setup closes.



Notes:

- When Act is selected and Zone 2 turned on, the Zone 2 speakers connected to the ZONE 2 L/R speaker terminals output sound, but the surround back speakers connected to the SURR BACK L/R speaker terminals do not. When Act is selected and Zone 2 turned off, the surround back speakers output sound as normal.
- Powered Zone 2 cannot be used if Speaker Type is set to Bi-Amp.
- This procedure can also be performed on the AV receiver by using its [SETUP], [ENTER], and arrow buttons.

Using Zone 2

This section explains how to turn Zone 2 on and off, how to select an input source for Zone 2, and how to adjust the volume for Zone 2.

Controlling Zone 2 from the AV receiver

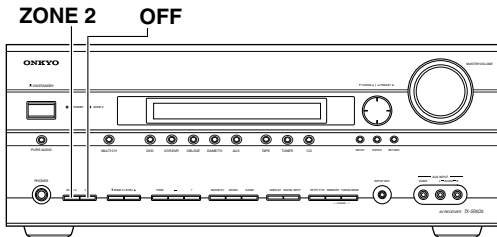

1



To turn on Zone 2 and select an input source, press the [ZONE 2] button repeatedly.

Alternatively, press the [ZONE 2] button followed by an input selector button within 8 seconds.

Zone 2 turns on and ZONE 2 indicator lights up.

To select the same source as that of the main room, Zone 2, press the [ZONE 2] button repeatedly until “Z2 Sel: Source” appears.

To select AM or FM press the [TUNER] input selector button repeatedly. On the North American model, you can also select SIRIUS.

Note:

- You cannot select different AM or FM radio stations for your main room, Zone 2. The same AM/FM radio station will be heard in each room.

2

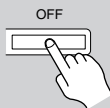

To turn off Zone 2, press the ZONE 2 [OFF] button.

Notes:

- Only analog input sources are output by Zone 2. Digital input sources are not output. If no sound is heard when an input source is selected, check to make sure it's connected to an analog input.

- While Zone 2 is on, the Auto Power On/Standby and Direct Change **RI** functions do not work.
- While Powered Zone 2 is being used, listening modes that require surround back speakers (6.1/7.1), such as Dolby Digital EX and DTS-ES are unavailable.

Controlling Zone 2 with the Remote Controller

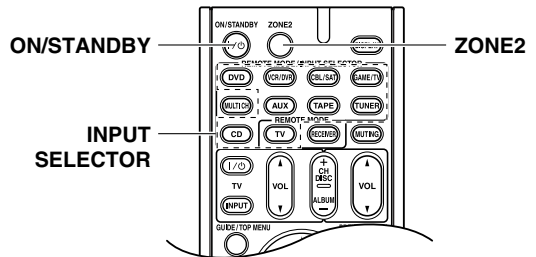

1 ZONE2



Press the [ZONE 2] button, then point the remote controller at the AV receiver and press the [ON/STANDBY] button.

Zone 2 turns on and ZONE 2 indicator lights up.

2 ZONE2



To select an input source for Zone 2, press the [ZONE 2] button, followed by an INPUT SELECTOR button.

To select AM or FM press the [TUNER] INPUT SELECTOR button repeatedly. On the North American model, you can also select SIRIUS.

Note:

- You cannot select different AM or FM radio stations for your main room, Zone 2. The same AM/FM radio station will be heard in each room.

3 ZONE2



To turn off Zone 2, press the [ZONE 2] button, followed by the [ON/STANDBY] button.

Zone 2—Continued

Note:

- To control Zone 2, you must press the remote controller's [ZONE 2] button first.

Adjusting the Volume of Zones

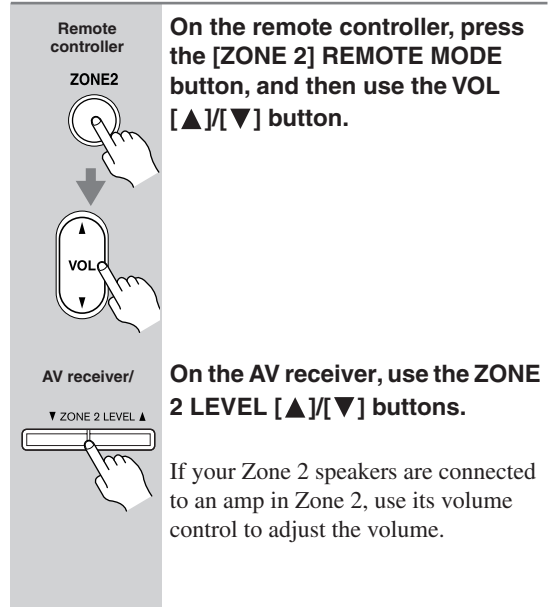

Remote controller
ZONE2



↓

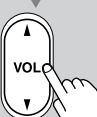

AV receiver/
▼ ZONE 2 LEVEL ▲

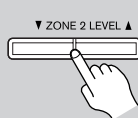

On the remote controller, press the [ZONE 2] REMOTE MODE button, and then use the VOL [▲]/[▼] button.

On the AV receiver, use the ZONE 2 LEVEL [▲]/[▼] buttons.

If your Zone 2 speakers are connected to an amp in Zone 2, use its volume control to adjust the volume.

Muting Zones

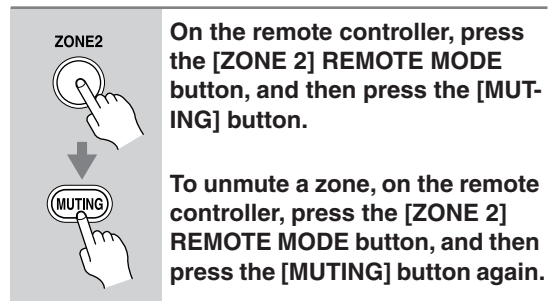

ZONE2



↓



On the remote controller, press the [ZONE 2] REMOTE MODE button, and then press the [MUTING] button.

To unmute a zone, on the remote controller, press the [ZONE 2] REMOTE MODE button, and then press the [MUTING] button again.

Controlling Other Components

You can control your DVD player, CD player, and other components with the AV receiver's remote controller.



To control another component, you must first enter that component's remote control code to a REMOTE MODE button.

This section explains how to enter remote control codes and how to control your other components.

Preprogrammed Remote Control Codes

The following REMOTE MODE buttons are preprogrammed with remote control codes for controlling the components listed. You do not need to enter a remote control code to control these components.

For details on controlling these components, see the pages indicated.

-  Onkyo DVD player (page 90)
-  Onkyo CD player (page 93)
-  Onkyo cassette recorder with **RI** (page 95)

Entering Remote Control Codes

You'll need to enter a code for each component that you want to control.

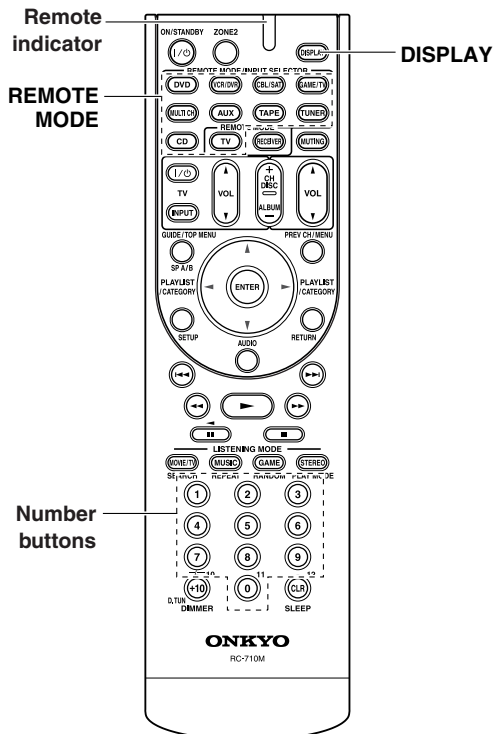

1

Look up the component's remote control code in the separate Remote Control Codes list.

The codes are organized by category.

2

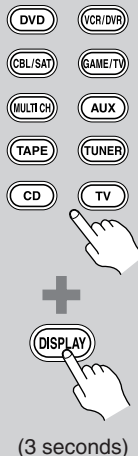

While holding down the REMOTE MODE button to which you want to enter a code, press and hold down the [DISPLAY] button until the Remote indicator lights up (about 3 seconds).

Note:

- Remote control codes cannot be entered for the [RECEIVER] and [ZONE 2] REMOTE MODE buttons.
- Only TV remote control codes can be entered for the [TV] REMOTE MODE button.
- Apart from the [RECEIVER], [TV], and [ZONE 2] REMOTE MODE buttons, remote control codes from any category can be entered for the REMOTE MODE buttons. However, these buttons also work as input selector buttons (page 47), so choose a REMOTE MODE button that corresponds with the input to which you connect your component. For example, if you connect your CD player to the CD input, choose the [CD] REMOTE MODE button when entering its remote control code.

3

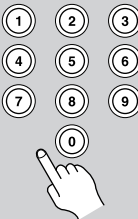

Within 30 seconds, use the number buttons to enter the 5-digit remote control code.

The Remote indicator flashes twice. If the remote control code is not entered successfully, the Remote indicator will flash once slowly.

Note:

- The remote control codes provided are correct at the time of printing but subject to change.

Remote Control Codes for Onkyo Components Connected via RI

Onkyo components that are connected via **RI** are controlled by pointing the remote controller at the AV receiver, not the component. This allows you to control components that are out of view, in a rack, for example.

1 Make sure the Onkyo component is connected with an **RI** cable and an analog audio cable (RCA).

See page 36 for details.

2 Enter the appropriate remote control code to the REMOTE MODE button.

- [DVD] REMOTE MODE button
31612: Onkyo DVD player with **RI**
- [CD] REMOTE MODE button
71327: Onkyo CD player with **RI**
- [TAPE] REMOTE MODE button
42157: Onkyo cassette recorder with **RI** (default)

See the previous page for how to enter remote control codes.

3 Press the REMOTE MODE button, point the remote controller at the AV receiver, and operate the component.

If you want to control an Onkyo component by pointing the remote controller directly at it, or you want to control an Onkyo component that's not connected via **RI**, use the following remote control codes:

- [DVD] REMOTE MODE button
30627: Onkyo DVD player without **RI** (default)
- [CD] REMOTE MODE button
71817: Onkyo CD player without **RI** (default)

Note:

- If you connect an **RI**-capable Onkyo MiniDisc recorder, CD recorder, or RI Dock to the TAPE IN/OUT jacks, or connect an RI Dock to the GAME/TV jacks, for **RI** to work properly, you must set the Input Display accordingly (see page 45).

Resetting the REMOTE MODE Buttons

You can reset a REMOTE MODE button to its default remote control code.

<p>1</p> <p>(3 seconds)</p>	<p>While holding down the REMOTE MODE button that you want to reset, press and hold down the [AUDIO] button until the Remote indicator lights up (about 3 seconds).</p>
<p>2</p>	<p>Within 30 seconds, press the REMOTE MODE button again.</p> <p>The Remote indicator flashes twice, indicating that the button has been reset.</p> <p>Each of the REMOTE MODE buttons is preprogrammed with a remote control code. When a button is reset, its preprogrammed code is restored.</p>

Resetting the Remote Controller

You can reset the remote controller to its default settings.

<p>1</p> <p>(3 seconds)</p>	<p>While holding down the [RECEIVER] REMOTE MODE button, press and hold down the [AUDIO] button until the Remote indicator lights up (about 3 seconds).</p>
<p>2</p>	<p>Within 30 seconds, press the [RECEIVER] REMOTE MODE button again.</p> <p>The Remote indicator flashes twice, indicating that the remote controller has been reset.</p>

Controlling a TV

By pressing the [TV] or [GAME/TV] REMOTE MODE buttons that's been programmed with the remote control code for your TV (TV/DVD combination or TV/VCR combination), you can control your TV with the following buttons.

For details on entering a remote control code for a different component, see page 87.

The [TV] and [GAME/TV] REMOTE MODE buttons are preprogrammed with the remote control code for controlling a TV that supports the RIHD*. The TV must be able to receive remote control commands via RIHD and be connected to the AV receiver via HDMI. If controlling your TV via RIHD doesn't work very well, program your TV's remote control code into the [TV] REMOTE MODE button and use the TV remote mode to control your TV.

Press [TV] REMOTE MODE button first

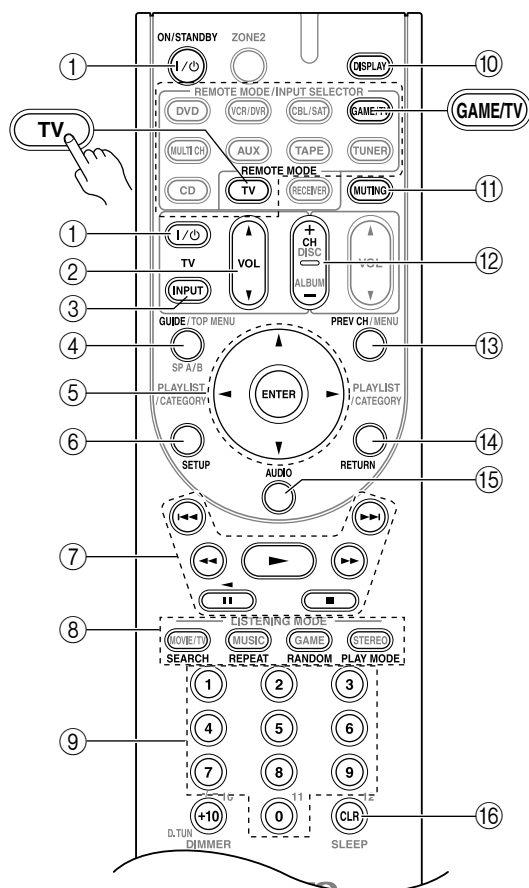

- ① **ON/STANDBY, TV [I/⏻] buttons**
Set the TV to On or Standby.
- ② **TV VOL [▲]/[▼]**
Adjust the TV's volume.
- ③ **TV [INPUT] button**
Selects the TV's external inputs.
- ④ **GUIDE button**
Displays the program guide.
- ⑤ **Arrow [▲]/[▼]/[◀]/[▶] and ENTER buttons**
Used to navigate menus and select items.
- ⑥ **SETUP button**
Displays a menu.
- ⑦ **Playback buttons**
From left to right: Previous, Rewind, Pause, Play, Stop, Fast Forward, and Next.
These buttons works for combination devices.
- ⑧ **SEARCH, REPEAT, RANDOM, and PLAY MODE buttons**
Function as colored buttons or A, B, C, D buttons.
- ⑨ **Number buttons**
Enter numbers. 0 button enters 11 on some components. +10 button works as “-.-” button or +10.
- ⑩ **DISPLAY button**
Displays information.
- ⑪ **MUTING button**
Mutes the TV.
- ⑫ **CH +/- button**
Select channels on the TV.
- ⑬ **PREV CH button**
Selects the previous or last channel.
- ⑭ **RETURN button**
Exits the TV's setup menu.
- ⑮ **AUDIO button**
Selects foreign language soundtracks and audio formats (e.g., Dolby Digital or DTS).
- ⑯ **CLR button**
Cancels functions and clears entered numbers, or enters 12.

* With some components, certain buttons may not work as expected, and some may not work at all.

Controlling a DVD Player, or DVD Recorder

By pressing the REMOTE MODE button that's been programmed with the remote control code for your DVD player (HD DVD, Blu-ray, or TV/DVD combination), you can control your player with the following buttons.

The [DVD] REMOTE MODE button is preprogrammed with the remote control code for controlling an Onkyo DVD player.

For details on entering a remote control code for a different component, see page 87.

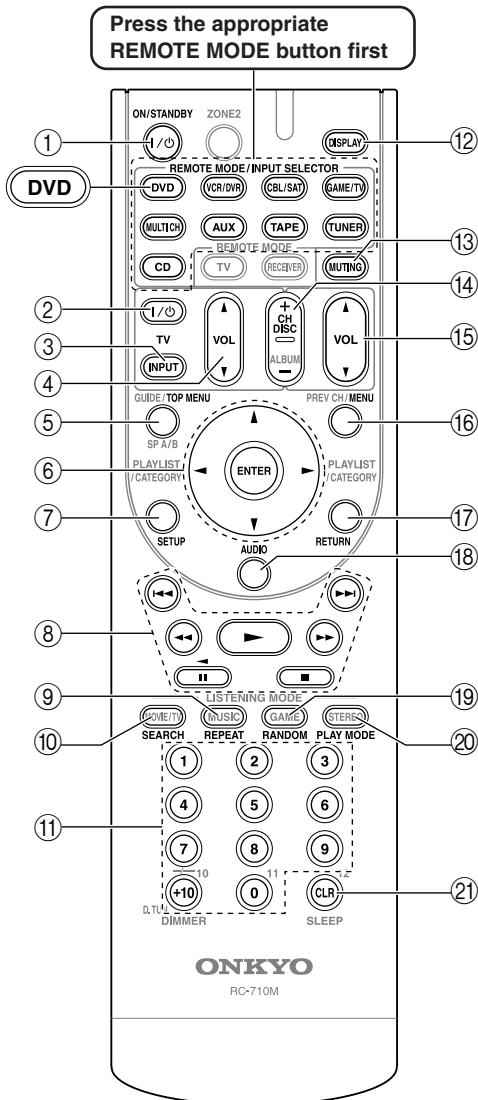

* With some components, certain buttons may not work as expected, and some may not work at all.

- ① **ON/STANDBY button**
Sets the DVD player to On or Standby.
- ② **TV [I/O] buttons**
Set the TV to On or Standby.
- ③ **TV [INPUT] button**
Selects the TV's external inputs.
- ④ **TV VOL [▲]/[▼]**
Adjust the TV's volume.
- ⑤ **TOP MENU button**
Displays a DVD's top menu or a DVD's title.
- ⑥ **Arrow [▲]/[▼]/[◀]/[▶] and ENTER buttons**
Used to navigate menus and select items.
- ⑦ **SETUP button**
Used to access the DVD player's settings.
- ⑧ **Playback buttons**
From left to right: Previous, Next, Rewind, Play, Fast Forward, Pause, and Stop.
- ⑨ **REPEAT button**
Used with the repeat playback function.
- ⑩ **SEARCH buttons**
Used to search title, chapter, and track numbers, and to search times for locating specific points.
- ⑪ **Number buttons**
Used to enter title, chapter, and track numbers, and to enter times for locating specific points. The [+10] button works as a +10 button or “-.-” button.
- ⑫ **DISPLAY button**
Displays information about the current disc, title, chapter, or track, including elapsed time, remaining time, total time, and so on.
- ⑬ **MUTING button (48)**
Mutes or unmutes the AV receiver.
- ⑭ **DISC +/-, CH +/- button**
Selects discs on a DVD changer. Selects TV channels on a component with a built-in tuner.
- ⑮ **VOL [▲]/[▼] button (47)**
Adjusts the volume of the AV receiver.
- ⑯ **MENU button**
Displays a DVD's menu.
- ⑰ **RETURN button**
Exits the DVD player's setup menu or returns to the previous menu.
- ⑱ **AUDIO button**
Selects foreign language soundtracks and audio formats (e.g., Dolby Digital or DTS).
- ⑲ **RANDOM button**
Used with the random playback function.

Controlling Other Components—Continued

- 20 **PLAY MODE button**
Selects play modes on components with selectable play modes.
- 21 **CLR button**
Cancels functions and clears entered numbers.

Note:

- If you enter the remote control code for a HD DVD or Blu-ray player that has A, B, C, and D or colored buttons, the [SEARCH], [REPEAT], [RANDOM], and [PLAY MODE] buttons will work as colored or A, B, C, D buttons. In this case, these buttons cannot be used to set repeat playback, random playback, or select play modes.

Controlling a VCR or PVR

By pressing the REMOTE MODE button that's been programmed with the remote control code for your VCR (TV/VCR, PVR, DBS/PVR combination or cable/PVR combination), you can control your video recorder with the following buttons.

For details on entering a remote control code for a different component, see page 87.

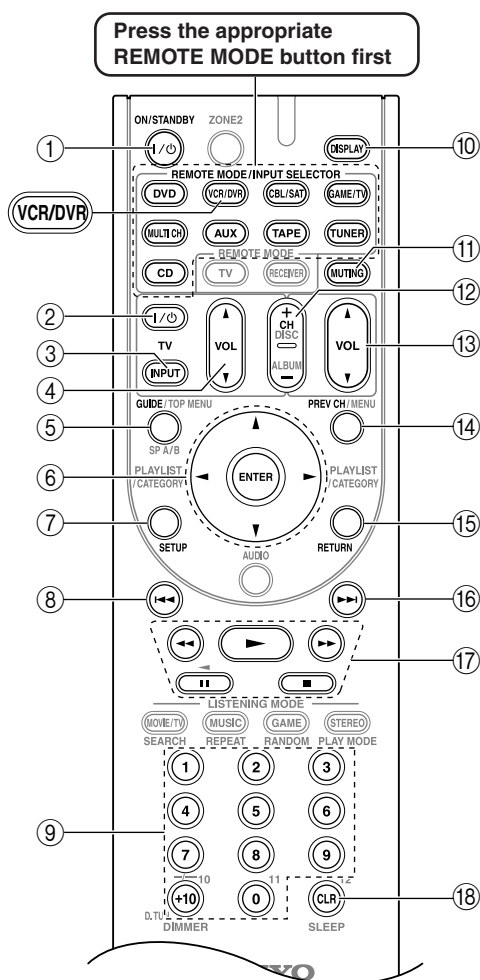

* With some components, certain buttons may not work as expected, and some may not work at all.

- 1 **ON/STANDBY button**
Set the video recorder to On or Standby.
- 2 **TV [I/⏻] buttons**
Set the TV to On or Standby.
- 3 **TV [INPUT] button**
Selects the TV's external inputs.
- 4 **TV VOL [▲]/[▼]**
Adjust the TV's volume.
- 5 **GUIDE button**
Displays the program guide or navigation list.
- 6 **Arrow [▲]/[▼]/[◀]/[▶] and ENTER buttons**
Used to navigate menus and select items.
- 7 **SETUP button**
Displays the video recorders setup menu.
- 8 **Previous [◀◀] button**
Previous or instant replay function.
- 9 **Number buttons**
Enter numbers. The [0] button enters 11 on some components. The [+10] button works as a +10 button or "--" button.
- 10 **DISPLAY button**
Displays information.
- 11 **MUTING button (48)**
Mutes or unmutes the AV receiver.
- 12 **CH +/- button**
Selects TV channels on the video recorder.
- 13 **VOL [▲]/[▼] button (47)**
Adjusts the volume of the AV receiver.
- 14 **PREV CH button**
Selects the previous channel.
- 15 **RETURN button**
Exits the menu or returns to the previous menu.
- 16 **Next [▶▶] button**
Next or advance function.
- 17 **Playback buttons**
From left to right: Previous, Next, Rewind, Play, Fast Forward, Pause, and Stop.
- 18 **CLR button**
Cancels functions or enters the number 12.

Controlling a Satellite Receiver or Cable Receiver

By pressing the REMOTE MODE button that's been programmed with the remote control code for your satellite receiver, cable receiver, or DVD recorder (DBS/PVR combination or cable/PVR combination), you can control your player with the following buttons.

For details on entering a remote control code for a different component, see page 87.

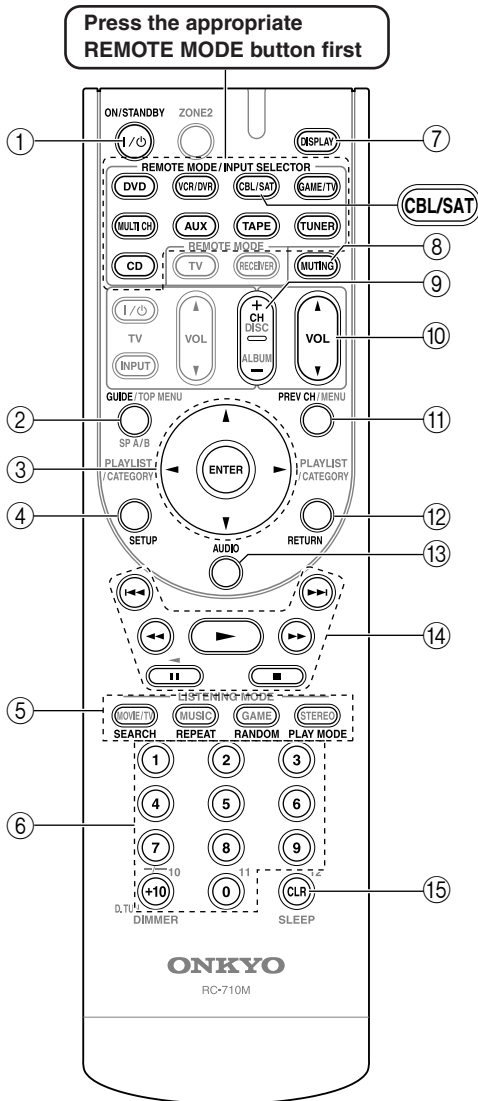

- ① **ON/STANDBY button**
Set the component to On or Standby.
- ② **GUIDE button**
Displays the onscreen program guide.
- ③ **Arrow [▲]/[▼]/[◀]/[▶] and ENTER buttons**
Used to navigate menus and select items.
- ④ **SETUP button**
Displays the setup menu.
- ⑤ **SEARCH, REPEAT, RANDOM, and PLAY MODE buttons**
Function as colored buttons or A, B, C, D buttons.
- ⑥ **Number buttons**
Enter numbers. The [+10] button works as a +10 button or “-.-” button.
- ⑦ **DISPLAY button**
Displays information.
- ⑧ **MUTING button (48)**
Mutes or unmutes the AV receiver.
- ⑨ **CH +/- button**
Selects satellite/cable channels.
- ⑩ **VOL [▲]/[▼] button (47)**
Adjusts the volume of the AV receiver.
- ⑪ **PREV CH button**
Selects the previous channel.
- ⑫ **RETURN button**
Exits the menu.
- ⑬ **AUDIO button**
Selects foreign language soundtracks and audio formats (e.g., Dolby Digital or DTS).
- ⑭ **Playback buttons**
From left to right: Previous, Next, Rewind, Play, Fast Forward, Pause, and Stop.
- ⑮ **CLR button**
Cancels functions and clears entered numbers.

* With some components, certain buttons may not work as expected, and some may not work at all.

Controlling a CD Player, CD Recorder, or MD Player

By pressing the REMOTE MODE button that's been programmed with the remote control code for your CD player, CD recorder, or MD player, you can control your player with the following buttons.

The [CD] REMOTE MODE button is preprogrammed with the remote control code for controlling an Onkyo CD player.

For details on entering a remote control code for a different component, see page 87.

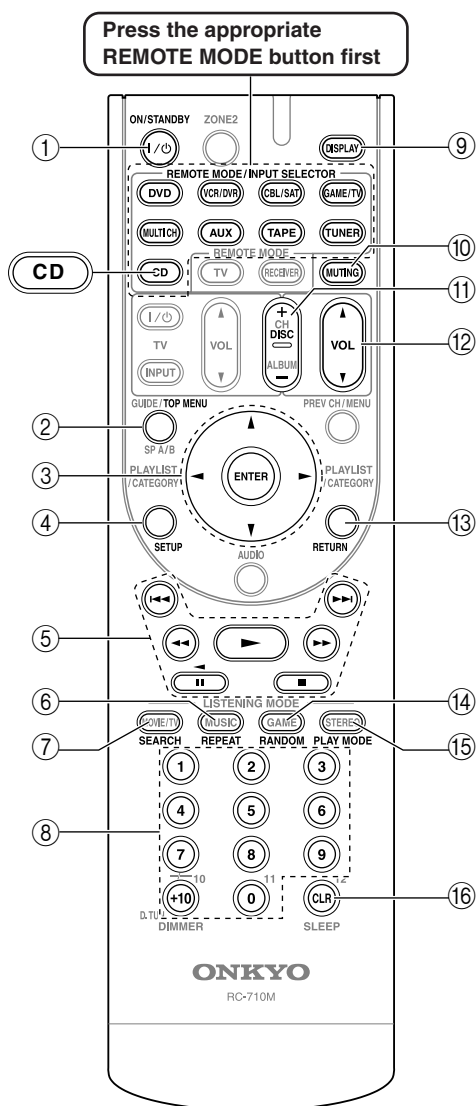

- ① **ON/STANDBY button**
Set the component to On or Standby.
- ② **TOP MENU button**
Displays a menu.
- ③ **Arrow [▲]/[▼]/[◀]/[▶] and ENTER buttons**
Used to navigate menus and select items.
- ④ **SETUP button**
Used to access the Onkyo CD player's settings.
- ⑤ **Playback buttons**
From left to right: Previous, Rewind, Pause, Play, Stop, Fast Forward, and Next.
- ⑥ **REPEAT button**
Used with the repeat playback function.
- ⑦ **SEARCH button**
Used to locate specific points.
- ⑧ **Number buttons**
Used to enter track numbers and times for locating specific points. The [+10] button works as a +10 button or "..." button.
- ⑨ **DISPLAY button**
Displays information about the current disc or track, including elapsed time, remaining time, total time, and so on.
- ⑩ **MUTING button (48)**
Mutes or unmutes the AV receiver.
- ⑪ **DISC +/- button**
Selects discs on a CD changer.
- ⑫ **VOL [▲]/[▼] button (47)**
Adjusts the volume of the AV receiver.
- ⑬ **RETURN button**
Exits the menu.
- ⑭ **RANDOM button**
Used with the random playback function.
- ⑮ **PLAY MODE button**
Selects play modes on components with selectable play modes.
- ⑯ **CLR button**
Cancels functions and clears entered numbers.

* With some components, certain buttons may not work as expected, and some may not work at all.

Controlling an RI Dock

By pressing the REMOTE MODE button that's been programmed with the remote control code for your RI Dock, you can control your iPod in the RI Dock with the following buttons.

For details on entering a remote control code, see page 87.

When Using an RI Dock:

- Connect the RI Dock to the TAPE IN or GAME/TV IN L/R jacks.
- Set the RI Dock's RI MODE switch to HDD or HDD/DOCK.
- Set the AV receiver's Input Display to DOCK (see page 45).
- See to the RI Dock's instruction manual for more information.

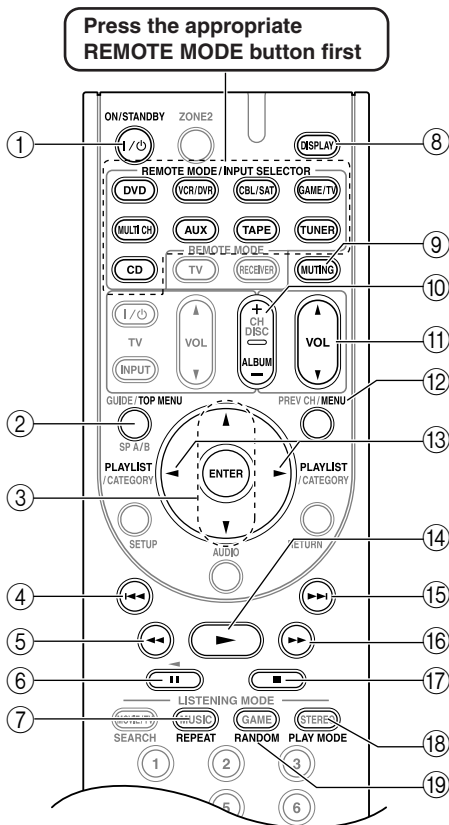

* With some components, certain buttons may not work as expected, and some may not work at all.

① ON/STANDBY button

Turns the iPod on or off.

Notes:

- This button does not turn the Onkyo DS-A2 or DS-A2X RI Dock on or off.
- Your iPod may not respond the first time you press this button, in which case you should press it again. This is because the remote controller transmits the On and Standby commands alternately, so if your iPod is already on, it will remain on when the remote controller transmits an On command. Similarly, if your iPod is already off, it will remain off when the remote controller transmits an Off command.

② TOP MENU button

Works as a Mode button when used with a DS-A2 RI Dock.

③ Arrow [▲]/[▼] and ENTER buttons*

Used to navigate menus and select items.

④ Previous [◀] button

Restarts the current song. Press it twice to select the previous song.

⑤ Rewind [◀◀] button

Press and hold to rewind.

⑥ Pause [||] button

Pauses playback. (With 3rd generation iPod models, it works as a Play/Pause button.)

⑦ REPEAT button*

Used with the repeat function.

⑧ DISPLAY button*

Turns on the backlight for 30 seconds.

⑨ MUTING button (48)

Mutes or unmutes the AV receiver.

⑩ ALBUM +/- button*

Selects the next or previous album.

⑪ VOL [▲]/[▼] button (47)

Adjusts the volume of the AV receiver.

⑫ MENU button*

Displays a menu.

⑬ PLAYLIST [◀]/[▶] buttons*

Selects the previous or next playlist on the iPod.

⑭ Play [▶] button

Starts playback. If the component is off, it will turn on automatically. (With 3rd generation iPod models, this button works as a Play/Pause button.)

⑮ Next [▶▶] button

Selects the next song.

Controlling Other Components—Continued

16 Fast Forward [▶▶] button

Press and hold to fast forward.

17 Stop [■] button

Stops playback and displays a menu.

18 PLAY MODE button

Selects play modes on components with selectable play modes.

Works as a Resume button when used with a DS-A2 RI Dock.

19 RANDOM button*

Used with the shuffle function.

* Buttons marked with an asterisk (*) are not supported by 3rd generation iPod models.

Controlling a Cassette Recorder

By pressing the REMOTE MODE button that's been programmed with the remote control code for your cassette recorder, you can control your cassette recorder with the following buttons.

The [TAPE] REMOTE MODE button is preprogrammed with the remote control code for controlling an Onkyo cassette recorder when used with an **RI** connection.

For details on entering a remote control code for a different component, see page 87.

On twin cassette decks, only Deck B can be controlled.

1 ON/STANDBY button

Turns the cassette recorder on or off.

2 Previous and Next [◀◀]/[▶▶] buttons

The Previous [◀◀] button selects the previous track. During playback it selects the beginning of the current track. The Next [▶▶] button selects the next track.

Depending on how they were recorded, the Previous and Next [◀◀]/[▶▶] buttons may not work properly with some cassette tapes.

3 Rewind and Fast Forward [◀◀]/[▶▶] buttons

The Rewind [◀◀] button starts rewind. The Fast Forward [▶▶] button starts fast forward.

4 Reverse Play [◀] button

Starts reverse playback.

5 Play [▶] button

Starts playback.

6 MUTING button (48)

Mutes or unmutes the AV receiver.

7 VOL [▲]/[▼] button (47)

Adjusts the volume of the AV receiver.

8 Stop [■] button

Stops playback.

Note:

- An Onkyo cassette recorder connected via **RI** can also be controlled in Receiver mode.

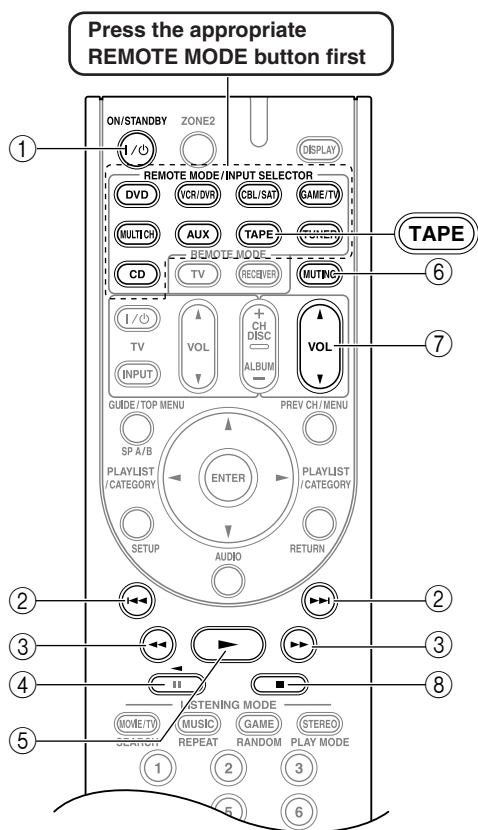

* With some components, certain buttons may not work as expected, and some may not work at all.

Troubleshooting

If you have any trouble using the AV receiver, look for a solution in this section. If you can't resolve the issue yourself, contact your Onkyo dealer.

If you can't resolve the issue yourself, try resetting the AV receiver before contacting your Onkyo dealer.

To reset the AV receiver to its factory defaults, turn it on and, while holding down the [VCR/DVR] button, press the [ON/STANDBY] button. "Clear" will appear on the display and the AV receiver will enter Standby mode.



Note that resetting the AV receiver will delete your radio presets and custom settings.

The onscreen setup menus appear only on a TV that is connected to the HDMI OUT. If your TV is connected to the composite video or S-Video MONITOR OUT, or the COMPONENT VIDEO OUT, use the TX-SR606's display when changing settings.

Power

Can't turn on the AV receiver

- Make sure that the power cord is plugged into the wall outlet properly.
- Unplug the power cord from the wall outlet, wait 5 seconds or more, then plug it back in again.

The AV receiver turns off as soon as it's turned on

- The amp protection circuit has been activated. Remove the power cord from the wall outlet immediately. Disconnect all speaker cables and input sources, and leave the AV receiver with its power cord disconnected for 1 hour. After that, reconnect the power cord and set the volume to maximum. If the AV receiver stays on, set the volume to minimum, disconnect the power cord, and reconnect your speakers and input sources. If the AV receiver turns off when you set the volume to maximum, disconnect the power cord, and contact your Onkyo dealer.

Audio

There's no sound or it's very quiet

- To listen to an audio source that's connected to an HDMI input, make sure that input is assigned to an input selector (page 43).
- To listen to an audio source that's connected to an OPTICAL or COAXIAL input, make sure that input is assigned to an input selector (page 44).
- Make sure that all audio connecting plugs are pushed in all the way (page 20).
- Make sure that the polarity of the speaker cables is correct, and that the bare wire is in contact with the metal part of each speaker terminal (page 16).

- Make sure that the speaker cables are not shorting.
- Check the volume (page 47). The AV receiver is designed for home theater enjoyment and has a wide volume range for precise adjustment.
- If the MUTING indicator is flashing on the display, press the remote controller's [MUTING] button to unmute the AV receiver (page 48).
- While a pair of headphones is connected to the PHONES jack, no sound is output by the main room speakers (page 49).
- Check the digital audio output settings on the source component. On some game consoles, such as those that can play DVDs, the default setting is off.
- With some DVD-Video discs, you need to select an audio format from a menu or with the AUDIO button on your DVD player's remote controller.
- If your turntable doesn't have a phono preamp built-in, you must connect one between it and the AV receiver.
- If your turntable uses an MC cartridge, you must connect an MC head amp, or an MC transformer and a phono preamp.
- Check the speaker settings (pages 72–76).
- If the digital signal format is set to PCM or DTS, set it to Auto (page 50).
- If there's no sound from a DVD player connected to an HDMI IN, check the DVD player's output settings, and be sure to select a compatible audio format.

Only the front speakers produce sound

- When the Stereo or Mono listening mode is selected, only the front speakers and subwoofer produce sound.
- Check the Speaker Configuration (page 72).

Only the center speaker produces sound

- If you use the Dolby Pro Logic IIx Movie or Dolby Pro Logic IIx Music listening mode with a mono source, such as an AM radio station or mono TV program, the sound will be concentrated in the center speaker.
- Check the Speaker Configuration (page 72).

The center speaker produces no sound

- When the Stereo or Mono listening mode is selected, the center speaker produces no sound (page 64).
- Check the Speaker Configuration (page 72).

The surround speakers produce no sound

- When the Stereo or Mono listening mode is selected, the surround speakers produce no sound.
- Depending on the source and the current listening mode, not much sound may be produced by the surround speakers. Try another listening mode (page 57).
- Check the Speaker Configuration (page 72).

The surround back speakers produce no sound

- The surround back speakers are not used with all listening modes. Try another listening mode (page 57).
- Not much sound may be produced by the surround back speakers with some sources.
- Check the Speaker Configuration (page 72).

- While Powered Zone 2 is being used, playback in the main room is reduced to 5.1-channels and the surround back speakers produce no sound (page 83).

The subwoofer produces no sound

- If the source material contains no audio in the LFE channel, the subwoofer produces no sound.
- Check the Speaker Configuration (page 72).

The Zone 2 speakers produce no sound

- The Zone 2 speakers only output sources that are connected to an analog input. Check to see if the source component is connected to an analog input.
- Powered Zone 2 cannot be used if Speaker Type is set to Bi-Amp (page 42).

There's no sound with a certain signal format

- Check the digital audio output setting on the source component. On some game consoles, such as those that can play DVDs, the default setting is off.
- With some DVD-Video discs, you need to select an audio format from a menu or with the AUDIO button on your DVD player's remote controller.

Can't get 6.1- or 7.1-channel playback

- While Powered Zone 2 is being used, playback in the main room is reduced to 5.1-channels and the surround back speakers produce no sound (page 83).

Can't select the Pure Audio listening mode

- The Pure Audio listening mode cannot be selected while Zone 2 is on.
- The Pure Audio listening mode is not available on the North American model.

The volume cannot be set to 79

- Check to see if a maximum volume has been set (page 78).
- After the Automatic Speaker Setup function has been run, or the volume level of each individual speaker has been adjusted (pages 38 and 75), the maximum volume may be reduced.
- When the levels of each speaker have been adjusted (page 75), the maximum possible volume may be reduced.
- When the Equalizer setting (page 76) is set to Audyssey, the maximum possible volume is reduced by 6 dB.

Noise can be heard

- Using cable ties to bundle audio cables with power cords, speaker cables, and so on can degrade audio performance, so don't use them.
- An audio cable may be picking up interference. Try repositioning your cables.

The Late Night function doesn't work

- Make sure that the source is Dolby Digital or Dolby TrueHD (page 69).

The analog multichannel input doesn't work

- Check the multichannel input connections (page 25).

- Make sure that the multichannel input is selected (page 47).
- Check the audio output settings on your DVD player.

About DTS signals

- When playing DTS program material, using the pause, fast forward, or fast reverse function on your player may produce a short audible noise. This is not a malfunction.
- When DTS program material ends and the DTS bitstream stops, the AV receiver remains in DTS listening mode and the DTS indicator remains on. This is to prevent noise when you use the pause, fast forward, or fast reverse function on your player. If you switch your player from DTS to PCM, as the AV receiver does not switch formats immediately, you may not hear anything, in which case you should stop your player for about 3 seconds, and then resume playback.
- With some CD players, you won't be able to playback DTS material properly even though your player is connected to a digital input on the AV receiver. This is usually because the DTS bitstream has been processed (e.g., output level, sampling rate, or frequency response changed) and the AV receiver doesn't recognize it as a genuine DTS signal. In such cases, you may hear noise.

The beginning of audio received by an HDMI IN can't be heard

- Since it takes longer to identify the format of an HDMI signal than it does for other digital audio signals, sound may not be output immediately.

Video

There's no picture

- Make sure that all video connecting plugs are pushed in all the way (page 20).
- Make sure that each video component is properly connected.
- On your TV, make sure that the video input to which the AV receiver is connected is selected.
- While the Pure Audio listening mode is selected, the video circuitry is turned off and only the HDMI OUT outputs video signals.
- If the video source is connected to an HDMI input, you must assign that input to an input selector (page 43), and your TV must be connected to the HDMI OUT (page 31).
- If the video source is connected to a component video input, you must assign that input to an input selector (page 44), and your TV must be connected to either the HDMI OUT or COMPONENT VIDEO OUT (page 31, 23).
- If the video source is connected to an S-Video or composite video input, your TV must be connected to the HDMI OUT or the corresponding S-Video or composite video output (page 31, 23).

There's no picture from a source connected to an HDMI IN

- Reliable operation with an HDMI-to-DVI adapter is not guaranteed. In addition, video signals from a PC are not supported (page 31).
- If the message “Resolution Error” appears on the AV receiver's display, this indicates that your TV does not support the current video resolution and you need to select another resolution on your DVD player.

Tuner

Reception is noisy, stereo FM reception suffers from hiss, or the FM STEREO indicator doesn't light up

- Relocate your antenna.
- Move the AV receiver away from your TV or computer.
- When listening to an AM station, operating the remote controller may cause noise.
- Passing cars and airplanes can cause interference.
- Concrete walls weaken radio signals.
- If nothing improves the reception, install an outdoor antenna.

Remote Controller

The remote controller doesn't work

- Make sure that the batteries are installed with the correct polarity (page 13).
- Make sure that the remote controller is not too far away from the AV receiver and there's no obstruction between the remote controller and the AV receiver's remote control sensor (page 13).
- Make sure you've selected the correct remote controller mode.
- Make sure you've entered the correct remote control code (page 87).

Can't control other components

- Make sure you've selected the correct remote controller mode.
- If you've connected an **RI**-capable Onkyo MD recorder, CD recorder, or RI Dock to the TAPE IN/OUT jacks, or an RI Dock to the GAME/TV IN jacks, for the remote controller to work properly, you must set the Input Display to MD, CDR, or DOCK, respectively (see page 45).
- The entered remote control code may not be correct. If more than one code is listed, try each one.
- With some AV components, certain buttons may not work as expected, and some may not work at all.
- To control an Onkyo component that's connected via **RI**, point the remote controller at the AV receiver. Be sure to enter the appropriate remote control code first (page 88).

- To control an Onkyo component that's not connected via **RI**, or another manufacturer's component, point the remote controller at that component. Be sure to enter the appropriate remote control code first (page 87).

Recording

Can't record

- On your recorder, make sure the correct input is selected.
- To prevent signal loops and damage to the AV receiver, input signals are not fed through to outputs with the same name (e.g., TAPE IN to TAPE OUT or VCR/DVR IN to VCR/DVR OUT).
- When the Pure Audio listening mode is selected, video recording is not possible because no video signals are output. Select another listening mode.

Others

The sound changes when I connect my headphones

- When a pair of headphones is connected, the listening mode is set to Stereo, unless it's already set to Stereo, Mono, Direct, or Pure Audio, in which case it stays the same.

How do I change the language of a multiplex source

- On the “Audio Adjust” menu, change the “Input Ch” setting to Main or Sub (page 67).

The **RI** functions don't work

- To use **RI**, you must make an **RI** connection and an analog audio connection (RCA) between the component and AV receiver, even if they are connected digitally (page 36).
- While Zone 2 is selected, the **RI** functions don't work.

The AV receiver's display doesn't work

- The display is turned off when the Pure Audio listening mode is selected. Select another listening mode.

The following settings can be made for the S-Video and composite video inputs

You must use the buttons on the unit to make these settings.

1. While holding down the input selector button for the input source that you want to set, press the [SETUP] button.
2. Use the Left and Right [◀]/[▶] buttons to change the setting.
3. Press the [SETUP] button when you've finished.

• Video Attenuation

This setting can be made for the DVD, VCR/DVR, CBL/SAT, GAME/TV, or AUX input.

If you have a games console connected to the S-Video or composite video input, and the picture isn't very clear, you can attenuate the gain.

Video ATT:0: (default).

Video ATT:2: Gain is reduced by 2 dB.

The AV receiver contains a microcomputer for signal processing and control functions. In very rare situations, severe interference, noise from an external source, or static electricity may cause it to lockup. In the unlikely event that this happens, unplug the power cord from the wall outlet, wait at least 5 seconds, and then plug it back in again.

Onkyo is not responsible for damages (such as CD rental fees) due to unsuccessful recordings caused by this unit's malfunction. Before you record important data, make sure that the material will be recorded correctly.

Before disconnecting the power cord from the wall outlet, set the AV receiver to Standby.

Important Note Regarding Video Playback

The AV receiver can upconvert component video, S-Video, and composite video sources for display on a TV connected to the HDMI OUT. However, if the picture quality of the source is poor, upconversion may make the picture worse or disappear altogether.

In this case, try setting the HDMI Output Resolution setting (page 80) to 480p or 720p. If that doesn't improve the picture quality, try the following:

- 1. If the video source is connected to a component video input, connect your TV to the COMPONENT VIDEO OUT.**

If the video source is connected to an S-Video input, connect your TV to an S-Video output.

If the video source is connected to a composite video input, connect your TV to a composite video output.

- 2. On the main menu, select “1. Input Assign,” and then select “1. HDMI Input.”**
Select the relevant input selector, and assign it to “-----” (page 43).

- 3. On the main menu, select “1. Input Assign,” and then select “2. Component Video Input” (page 44):**

If the video source is connected to COMPONENT VIDEO IN 1, select the relevant input selector, and assign it to “IN1.”

If the video source is connected to COMPONENT VIDEO IN 2, select the relevant input selector, and assign it to “IN2.”

If the video source is connected to an S-Video input or composite video input, select the relevant input selector, and assign it to “-----”.

Specifications

Amplifier Section

Rated Output Power

North American:

90 watts minimum continuous power per channel, 8 ohm loads, from 20Hz to 20kHz, with a maximum total harmonic distortion of 0.08% (FTC)

105 watts minimum continuous power per channel, 8 ohm loads, at 1kHz, with a maximum total harmonic distortion of 0.7% (FTC)

130 watts minimum continuous power per channel, 6 ohm loads, at 1kHz, with a maximum total harmonic distortion of 1% (FTC)

European:

7 ch × 140 W at 6 ohms, 1kHz, 1 ch driven (IEC)

Asian and Oceanian:

7 ch × 175 W at 6 ohms, 1kHz, 1 ch driven (JEITA)

Dynamic Power	210 W (3Ω, Front) 180 W (4Ω, Front) 110 W (8Ω, Front)
THD (Total Harmonic Distortion)	0.08% (Power Rated) 0.08% (20Hz to 20kHz Power Rated)
Damping Factor	60 (Front, 1kHz, 8Ω)
Input Sensitivity and Impedance	200 mV/ 47 kΩ (LINE)
Output Level and Impedance	200 mV/ 2.2 kΩ (REC OUT)
Frequency Response	5Hz–100kHz/ +1 dB–3 dB (direct mode)
Tone Control	±10 dB, 50Hz (BASS) ±10 dB, 20kHz (TREBLE)
Signal to Noise Ratio	106 dB (LINE, IHF-A)
Speaker Impedance	North American: 6Ω–16Ω European: 4Ω–16Ω Asian and Oceanian: 4Ω–16Ω

Video Section

Input Sensitivity/Output

Level and Impedance	1 V _{p-p} /75Ω (Component and S-Video Y) 0.7 V _{p-p} /75Ω (Component Pb/Cb, Pr/Cr) 0.28 V _{p-p} /75Ω (S-Video C) 1 V _{p-p} /75Ω (Composite)
---------------------	--

Component Video

Frequency Response	5Hz – 50MHz, –3 dB
--------------------	--------------------

Tuner Section

■ FM

Tuning Frequency Range

North American:	87.5MHz–107.9MHz
European:	87.50MHz–108.00MHz, RDS
Asian and Oceanian:	87.50MHz–108.00MHz

■ AM

Tuning Frequency Range

North American:	530kHz–1710kHz
European:	522kHz–1611kHz
Asian and Oceanian:	522/530kHz–1611/1710kHz

■ Digital Tuner

North American:	SIRIUS
-----------------	--------

Preset Channel	40
----------------	----

General

Power Supply

North American:	AC 120 V, 60Hz
European:	AC 230 V, 50Hz
Asian and Oceanian:	with voltage selector model: AC 120/220–240 V, 50/60Hz without voltage selector model: AC 220 V, 50/60Hz

Power Consumption

North American:	5.5 A
European:	550 W
Asian and Oceanian:	with voltage selector model: 540 W without voltage selector model: 570 W

Dimensions

(W × H × D)	435 × 174.5 × 375 mm 17-1/8" × 6-7/8" × 14-3/4"
-------------	--

Weight

North American:	11.3 kg 24.9 lbs.
European:	11.4 kg 25.2 lbs.
Asian and Oceanian:	with voltage selector model: 11.6 kg, 25.6 lbs. without voltage selector model: 11.3 kg, 24.9 lbs.

■ Video Inputs

HDMI (Assignable)	IN 1, IN 2, IN 3, IN 4
Component	IN 1, IN 2
Composite	DVD, VCR/DVR, CBL/SAT, GAME/TV, AUX
S-Video	DVD, VCR/DVR, CBL/SAT, GAME/TV

■ Video Outputs

HDMI	OUT
Component	OUT
Composite	MONITOR OUT, VCR/DVR (REC OUT)
S-Video	MONITOR OUT, VCR/DVR (REC OUT)

■ Audio Inputs

Digital Inputs (Assignable)	2 (Rear OPT), 2 (Rear coax)
Analog Inputs	DVD (MULTICHANNEL), VCR/DVR, CBL/SAT, GAME/TV, AUX, TAPE, CD
Multichannel Inputs	7.1 ch

■ Audio Outputs

Analog Outputs	TAPE, VCR/DVR, ZONE 2
Subwoofer Pre Outputs	1
Speaker Outputs	Main (L, R, C, SL, SR, SBL, SBR) + ZONE2 (L, R)
Phones	1

■ Control Terminal

Control Terminal	Yes
------------------	-----

Specifications and features are subject to change without notice.

Video Resolution Chart

The following tables show how video signals at different resolutions are output by the AV receiver.

NTSC

Output Input		HDMI					COMPONENT					S-VIDEO		COMPOSITE		
		1080P	1080i	720P	480P	480i	1080P	1080i	720P	480P	480i	NTSC	PAL	NTSC	PAL	
HDMI	1080P	✓														
	1080i		✓													
	720P			✓												
	480P				✓											
	480i					✓										
COMPONENT	1080P															
	1080i		✓	✓			✓									
	720P		✓	✓				✓								
	480P		✓	✓	✓				✓							
	480i		✓	✓	✓	✓					✓					
S-VIDEO	480i		✓	✓	✓	✓						✓				
COMPOSITE	480i		✓	✓	✓	✓								✓		

PAL

Output Input		HDMI					COMPONENT					S-VIDEO		COMPOSITE		
		1080P	1080i	720P	576P	576i	1080P	1080i	720P	576P	576i	NTSC	PAL	NTSC	PAL	
HDMI	1080P	✓														
	1080i		✓													
	720P			✓												
	576P				✓											
	576i					✓										
COMPONENT	1080P															
	1080i		✓	✓			✓									
	720P		✓	✓				✓								
	576P		✓	✓	✓				✓							
	576i		✓	✓	✓	✓					✓					
S-VIDEO	576i		✓	✓	✓	✓						✓				
COMPOSITE	576i		✓	✓	✓	✓									✓	

Onscreen Setup Menus

The onscreen setup menus appear on the connected TV and provide a convenient way to change the AV receiver's various settings. Settings are organized into eight categories on the **main menu**, most containing a **submenu**.

The onscreen setup menus appear only on a TV that is connected to the HDMI OUT. If your TV is connected to the composite video or S-Video MONITOR OUT, or the COMPONENT VIDEO OUT, use the TX-SR606's display when changing settings.

Menu
1. Input Assign
2. Speaker Setup
3. Audio Adjust
4. Source Setup
5. Listening Mode Preset
6. Miscellaneous
7. Hardware Setup
8. Lock Setup

Menu Map

The following map shows how the setup menus are organized. Use the page numbers to locate information about items.

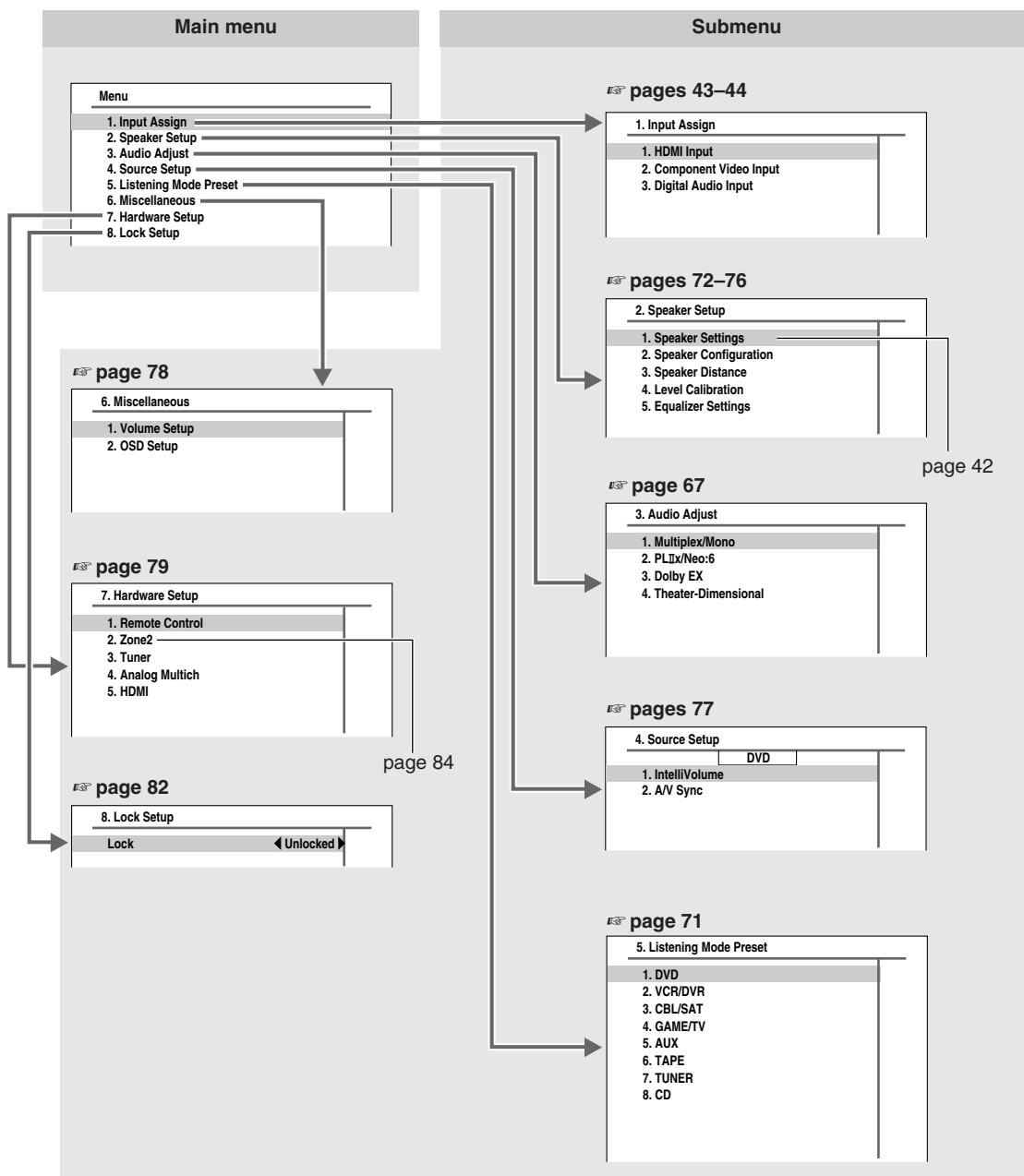

ONKYO CORPORATION

Sales & Product Planning Div. : 2-1, Nisshin-cho, Neyagawa-shi, OSAKA 572-8540, JAPAN
Tel: 072-831-8023 Fax: 072-831-8163

ONKYO U.S.A. CORPORATION

18 Park Way, Upper Saddle River, N.J. 07458, U.S.A.
Tel: 201-785-2600 Fax: 201-785-2650 <http://www.us.onkyo.com/>

ONKYO EUROPE ELECTRONICS GmbH

Liegnitzerstrasse 6, 82194 Groebenzell, GERMANY
Tel: +49-8142-4401-0 Fax: +49-8142-4401-555 <http://www.eu.onkyo.com/>

ONKYO EUROPE UK Office

Suite 1, Gregories Court, Gregories Road, Beaconsfield, Buckinghamshire, HP9 1HQ
UNITED KINGDOM Tel: +44-(0)1494-681515 Fax: +44(0)-1494-680452

ONKYO CHINA LIMITED

Unit 1&12, 9/F, Ever Gain Plaza Tower 1, 88, Container Port Road, Kwai Chung,
N.T., HONG KONG Tel: 852-2429-3118 Fax: 852-2428-9039
<http://www.ch.onkyo.com/>



I0806-1

SN 29344873

(C) Copyright 2008 ONKYO CORPORATION Japan. All rights reserved.

