

ONKYO®

Integrated Amplifier

A-5VL

Instruction Manual

Thank you for purchasing an Onkyo A-5VL Integrated Amplifier.

Please read this manual thoroughly before making connections and plugging in the unit.

Following the instructions in this manual will enable you to obtain optimum performance and listening enjoyment from your new A-5VL.

Please retain this manual for future reference.

Contents

Important Safety Instructions	2
Precautions	3
Features	4
Before Using This Product	5
Connecting to Other Devices	10
Enjoying Audio Sources (Operating the Unit)	15
Troubleshooting	17
Appendix	18

WARNING:

TO REDUCE THE RISK OF FIRE OR ELECTRIC SHOCK, DO NOT EXPOSE THIS APPARATUS TO RAIN OR MOISTURE.

CAUTION:

TO REDUCE THE RISK OF ELECTRIC SHOCK, DO NOT REMOVE COVER (OR BACK). NO USER-SERVICEABLE PARTS INSIDE. REFER SERVICING TO QUALIFIED SERVICE PERSONNEL.



WARNING
RISK OF ELECTRIC SHOCK
DO NOT OPEN

AVIS
RISQUE DE CHOC ELECTRIQUE
NE PAS OUVRIR



The lightning flash with arrowhead symbol, within an equilateral triangle, is intended to alert the user to the presence of uninsulated "dangerous voltage" within the product's enclosure that may be of sufficient magnitude to constitute a risk of electric shock to persons.



The exclamation point within an equilateral triangle is intended to alert the user to the presence of important operating and maintenance (servicing) instructions in the literature accompanying the appliance.

Important Safety Instructions

1. Read these instructions.
2. Keep these instructions.
3. Heed all warnings.
4. Follow all instructions.
5. Do not use this apparatus near water.
6. Clean only with dry cloth.
7. Do not block any ventilation openings. Install in accordance with the manufacturer's instructions.
8. Do not install near any heat sources such as radiators, heat registers, stoves, or other apparatus (including amplifiers) that produce heat.
9. Do not defeat the safety purpose of the polarized or grounding-type plug. A polarized plug has two blades with one wider than the other. A grounding type plug has two blades and a third grounding prong. The wide blade or the third prong are provided for your safety. If the provided plug does not fit into your outlet, consult an electrician for replacement of the obsolete outlet.
10. Protect the power cord from being walked on or pinched particularly at plugs, convenience receptacles, and the point where they exit from the apparatus.
11. Only use attachments/accessories specified by the manufacturer.
12. Use only with the cart, stand, tripod, bracket, or table specified by the manufacturer, or sold with the apparatus.
When a cart is used, use caution when moving the cart/ apparatus combination to avoid injury from tip-over.
13. Unplug this apparatus during lightning storms or when unused for long periods of time.
14. Refer all servicing to qualified service personnel. Servicing is required when the apparatus has been damaged in any way, such as power-supply cord or plug is damaged, liquid has been spilled or objects have fallen into the apparatus, the apparatus has been exposed to rain or moisture, does not operate normally, or has been dropped.
15. Damage Requiring Service
Unplug the apparatus from the wall outlet and refer servicing to qualified service personnel under the following conditions:
 - A. When the power-supply cord or plug is damaged,
 - B. If liquid has been spilled, or objects have fallen into the apparatus,
 - C. If the apparatus has been exposed to rain or water,
 - D. If the apparatus does not operate normally by following the operating instructions. Adjust only those controls that are covered by the operating instructions as an improper adjustment of other controls may result in damage and will often require extensive work by a qualified technician to restore the apparatus to its normal operation,
 - E. If the apparatus has been dropped or damaged in any way, and
 - F. When the apparatus exhibits a distinct change in performance this indicates a need for service.
16. Object and Liquid Entry
Never push objects of any kind into the apparatus through openings as they may touch dangerous voltage points or short-out parts that could result in a fire or electric shock. The apparatus shall not be exposed to dripping or splashing and no objects filled with liquids, such as vases shall be placed on the apparatus.
Don't put candles or other burning objects on top of this unit.
17. Batteries
Always consider the environmental issues and follow local regulations when disposing of batteries.
18. If you install the apparatus in a built-in installation, such as a bookcase or rack, ensure that there is adequate ventilation.
Leave 20 cm (8") of free space at the top and sides and 10 cm (4") at the rear. The rear edge of the shelf or board above the apparatus shall be set 10 cm (4") away from the rear panel or wall, creating a flue-like gap for warm air to escape.

PORTABLE CART WARNING



S3125A

Precautions

1. **Recording Copyright**—Unless it's for personal use only, recording copyrighted material is illegal without the permission of the copyright holder.
2. **AC Fuse**—The AC fuse inside the unit is not user serviceable. If you cannot turn on the unit, contact your Onkyo dealer.
3. **Care**—Occasionally you should dust the unit all over with a soft cloth. For stubborn stains, use a soft cloth dampened with a weak solution of mild detergent and water. Dry the unit immediately afterwards with a clean cloth. Don't use abrasive cloths, thinners, alcohol, or other chemical solvents, because they may damage the finish or remove the panel lettering.

4. Power

WARNING

BEFORE PLUGGING IN THE UNIT FOR THE FIRST TIME, READ THE FOLLOWING SECTION CAREFULLY.

AC outlet voltages vary from country to country. Make sure that the voltage in your area meets the voltage requirements printed on the unit's rear panel (e.g., AC 120 V, 60 Hz or AC 220-240 V, 50/60 Hz).

The power cord plug is used to disconnect this unit from the AC power source. Make sure that the plug is readily operable (easily accessible) at all times.

Pressing the [POWER] button to select OFF mode does not fully shutdown the unit. If you do not intend to use the unit for an extended period, remove the power cord from the AC outlet.

5. **Never Touch this Unit with Wet Hands**—Never handle this unit or its power cord while your hands are wet or damp. If water or any other liquid gets inside this unit, have it checked by your Onkyo dealer.
6. **Handling Notes**
 - If you need to transport this unit, use the original packaging to pack it how it was when you originally bought it.
 - Do not leave rubber or plastic items on this unit for a long time, because they may leave marks on the case.
 - This unit's top and rear panels may get warm after prolonged use. This is normal.
 - If you do not use this unit for a long time, it may not work properly the next time you turn it on, so be sure to use it occasionally.

For British models

Replacement and mounting of an AC plug on the power supply cord of this unit should be performed only by qualified service personnel.

IMPORTANT

The wires in the mains lead are coloured in accordance with the following code:

Blue:Neutral

Brown:Live

As the colours of the wires in the mains lead of this apparatus may not correspond with the coloured markings identifying the terminals in your plug, proceed as follows:

The wire which is coloured blue must be connected to the terminal which is marked with the letter N or coloured black.

The wire which is coloured brown must be connected to the terminal which is marked with the letter L or coloured red.

IMPORTANT

The plug is fitted with an appropriate fuse. If the fuse needs to be replaced, the replacement fuse must approved by ASTA or BSI to BS1362 and have the same ampere rating as that indicated on the plug. Check for the ASTA mark or the BSI mark on the body of the fuse.

If the power cord's plug is not suitable for your socket outlets, cut it off and fit a suitable plug. Fit a suitable fuse in the plug.

For European Models

Declaration of Conformity

We, ONKYO EUROPE
ELECTRONICS GmbH
LIEGNITZERSTRASSE 6,
82194 GROEBENZELL,
GERMANY



declare in own responsibility, that the ONKYO product described in this instruction manual is in compliance with the corresponding technical standards such as EN60065, EN55013, EN55020 and EN61000-3-2, -3-3.

GROEBENZELL, GERMANY

A handwritten signature in black ink, appearing to read 'K. Miyagi', is written over the printed name.

K. MIYAGI

ONKYO EUROPE ELECTRONICS GmbH

Features

- Exclusive Onkyo VLSC Technology
- Independent Transformers for L/R Channels
- New Custom-Designed, Audio Tuned Reference Capacitors
- Low-Impedance, Copper Bus Plates for Perfect Ground Potential
- 40 W/Ch into 8 Ω (FTC)-North American model, 60 W/Ch into 4 Ω (IEC)-European, other models
- 2 High-Grade 192 kHz/24-Bit D/A Converters
- Optimum Gain Volume Circuitry
- Precision Motor-Driven Volume Control
- Tone Control (Bass/Treble On/Off)
- Direct Mode
- Discrete Phono Equalizer Circuitry
- 4 Audio Inputs and 1 Output
- Phono Input (MM/MC)
- 2 Digital Inputs (Optical/Coaxial)
- 19 mm(3/4")-pitch Audio Terminals for High-Grade Cable
- Speaker A/B Drive
- Gold-Plated Transparent Speaker Posts
- Bi-Amping Capability
- Hi-Rigidity, Anti-Resonant Chassis
- Aluminum Front Panel and Volume Knob
- Headphone Jack
- Compatible with Onkyo RI-Dock for the iPod*
- Heavy-Duty Inlet Power Cord
- RI-Compatible Remote Control

*Depending on the model

Table of Contents

Important Safety Instructions	2
Precautions	3
Features.....	4
Before Using This Product	5
Check the Supplied Accessories	5
Getting the Remote Controller Ready.....	5
Names of Each Part.....	6
Remote Controller.....	8
Using the Remote Controller	9
Connecting to Other Devices.....	10
Precautions for Making Connections	10
Connecting Speakers.....	10
Connecting Audio Components	11
Connecting the Power Cord	14
Enjoying Audio Sources	
(Operating the Unit)	15
Adjusting the Tone and Left/Right	
Volume Balance.....	16
Recording	16
Troubleshooting.....	17
Power.....	17
Audio.....	17
Remote controller.....	17
Recording	17
Appendix	18
Specifications	18
Block Diagram	19

Before Using This Product

This section describes things to check and important information to know before using this product.

Check the Supplied Accessories

After opening the package, make sure that all the supplied accessories are included.

- Remote controller (RC-751S)[1]
- AA (R6) batteries[2]
(Not supplied with products for China.)
- Power cord (2 m / 6.5ft)
European models [2]
Other models [1]
(The shape differs depending on region.)

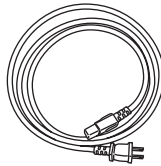
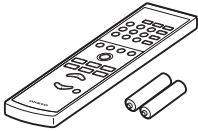

Getting the Remote Controller Ready

- 1** Press in the direction of the arrow and lift to remove the cover.

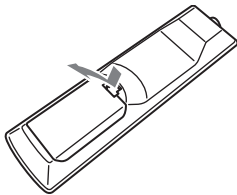

- 2** Insert the two supplied batteries, making sure to line up the plus \oplus and minus \ominus ends of the batteries with the symbols in the battery compartment.
(The battery is not supplied with products for China.)

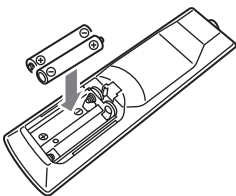

- 3** Close the cover.

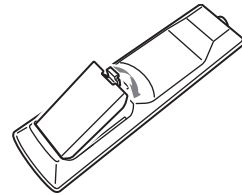

If the remote controller becomes unresponsive, replace the batteries with two new dry-cell batteries (AA).

- Be sure to insert the batteries correctly, in line with the charge symbols (\oplus and \ominus).
- Avoid mixing new batteries with old batteries, or mixing battery types.
- If you will not be using the remote controller for a prolonged period, remove the batteries in order to prevent corrosion.

Before Using This Product—Continued

Names of Each Part

Front Panel

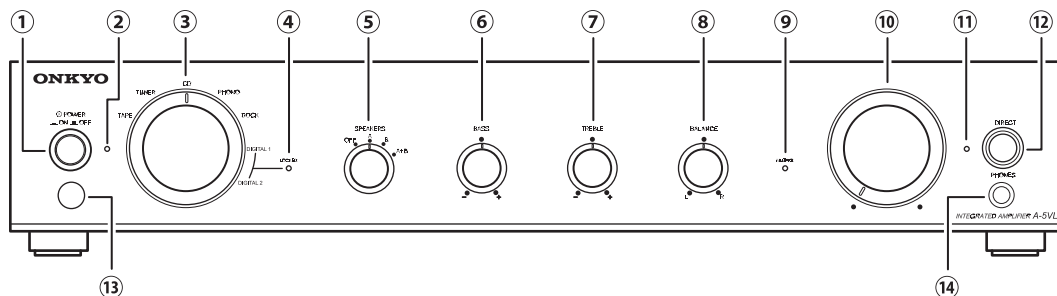

- ① **POWER button**
This button is used to turn the unit on and off.
- ② **POWER indicator**
Illuminates when the amp is on.
- ③ **Input selector control**
This control is used to select the playback device.
- ④ **LOCKED indicator**
Illuminates when there is audio signal input from the device connected to DIGITAL1 (COAXIAL) or DIGITAL2 (OPTICAL).
- ⑤ **SPEAKERS control**
This control sets the speaker output to A, B, A+B, or OFF.
- ⑥ **BASS control**
This control is used to adjust the bass volume.
- ⑦ **TREBLE control**
This control is used to adjust the treble volume.
- ⑧ **BALANCE control**
This control is used to adjust the left-right audio balance.
- ⑨ **MUTING indicator**
Illuminates when the volume is muted.
- ⑩ **VOLUME control**
This control adjusts the volume.
- ⑪ **DIRECT indicator**
Illuminates when there is direct output.
- ⑫ **DIRECT button**
This button selects whether to output the audio-signal input directly, or to output it through the amp, adjusting the BASS, TREBLE, and BALANCE.
- ⑬ **Remote control sensor**
- ⑭ **PHONES jack**
Stereo headphones with a standard plug can be plugged into this jack.

Before Using This Product—Continued

Rear Panel

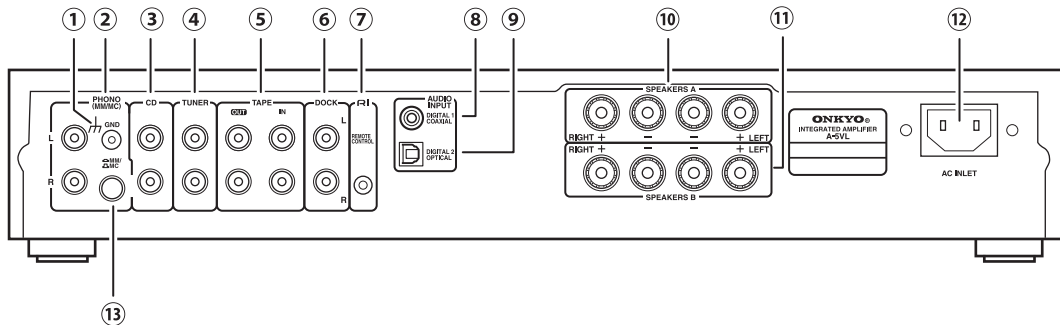

- ① **GND screw**
This screw is for connecting a turntable's ground wire.
- ② **PHONO (MM/MC) jacks**
Connect a turntable's audio output terminals into these jacks.
- ③ **CD jacks**
Connect a CD player's audio output terminals into these jacks.
- ④ **TUNER jacks**
Connect a tuner's audio output terminals into these jacks.
- ⑤ **TAPE IN/OUT**
Connect a cassette, MiniDisc Recorder, or other recording device to these jacks.
- ⑥ **DOCK**
Connect an Onkyo RI dock for the iPod here.
- ⑦ **RI REMOTE CONTROL**
Connect an Onkyo product with an **RI** plug (RI dock or tuner) here to link it to the amplifier.
- ⑧ **AUDIO INPUT DIGITAL 1 COAXIAL**
Connect a digital audio input here. This is for connecting a digital playback device.
- ⑨ **AUDIO INPUT DIGITAL 2 OPTICAL**
Connect a digital audio input here. This is for connecting a digital playback device.
- ⑩ **SPEAKERS A**
These terminal posts are for connecting speakers A.
- ⑪ **SPEAKERS B**
These terminal posts are for connecting speakers B.
- ⑫ **AC INLET**
The supplied power cord should be connected here.
- ⑬ **MM/MC selector**
Set this selector to the turntable's cartridge format (MM / MC).

Notes

Just connecting the **RI** cord will not link the connected device. Be sure to connect the audio cables as well.

! Caution

- Do not connect devices other than turntables to the **PHONO** inputs.
- Remove the short pins plugged into the jacks before connecting a turntable to the **PHONO** inputs.
- Switch to **MM** when using a high-output **MC** cartridge.

Remote Controller

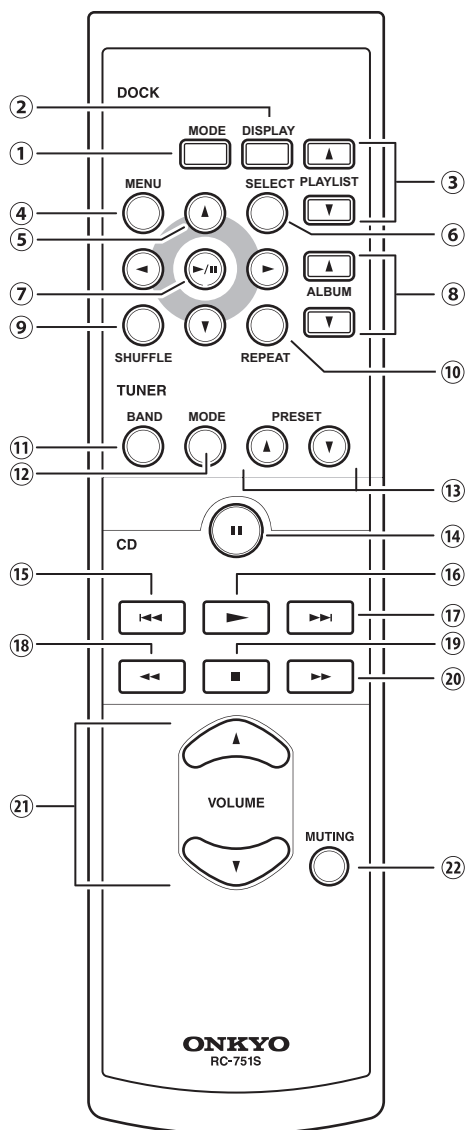

DOCK mode

This mode can be used to control an iPod mounted on an **RI** connected Onkyo RI dock.

- ① **MODE button (*)**
You can display track information from mounted devices on the monitor.
- ② **DISPLAY button (*)**
This button illuminates the iPod's backlight.
- ③ **PLAYLIST button**
Use this button to switch the current playlist.
- ④ **MENU button (*)**
Use this button to return to the previous iPod menu screen.
- ⑤ **▲▼◀▶ buttons**
Press the ▲ and ▼ buttons to select tracks and operate the iPod menu.
Press the ◀ and ▶ buttons to move the track up or down on the iPod. Press and hold to fast reverse or fast forward.
- ⑥ **SELECT button**
Use this button to make menu selections on the iPod.
- ⑦ **▶/|| buttons**
Use this button to start and pause playback on the iPod.
- ⑧ **ALBUM button**
Use this button to switch the album to play back.
- ⑨ **SHUFFLE button**
Use this button to switch the shuffle mode.
- ⑩ **REPEAT button (*)**
Use this button to switch the repeat mode.

Notes

- * Features marked with an asterisk (*) are not available with third-generation iPods.
- iPod is a trademark or registered trademark of Apple Inc. in the United States and other countries.
- Refer to the RI dock's manual for details.

Before Using This Product—Continued

TUNER mode

Use this mode to control an **RI** connected Onkyo tuner.

- ⑪ **BAND button**
Use this button to switch the reception band (FM/AM).
- ⑫ **MODE button**
Use this button to switch the reception mode when receiving FM broadcasts.
- ⑬ **PRESET button**
Use this button to select a preset broadcast station.

CD Mode

Use this mode to control a CD player.

- ⑭ **|| button**
Use this button to pause playback.
- ⑮ **◀◀ button**
Use this button to skip to the beginning of the track being played back.
- ⑯ **▶▶ button**
Use this button to play back.
- ⑰ **▶▶▶ button**
Use this button to skip to the beginning of the next track.
- ⑱ **◀◀ button**
Use this button to fast reverse.
- ⑲ **■ button**
Use this button to stop playback.
- ⑳ **▶▶▶ button**
Use this button to fast forward.

Common to All Modes

- ㉑ **VOLUME button**
Use this button to adjust the volume.
- ㉒ **MUTING button**
Temporarily set the audio to the minimum level. Press it again to return to the original volume.

Using the Remote Controller

Point the remote controller toward the remote control sensor, within the field shown in the drawing.

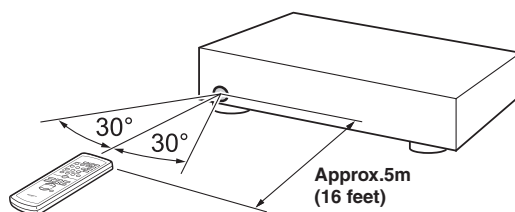

- Do not expose the remote control sensor to strong light, such as direct sunlight or inverted fluorescent light.
- Using the unit near equipment that emits infrared beams or with another remote controller may cause malfunctions.
- Make sure that the audio rack does not have colored glass, as this could prevent the remote controller from functioning properly.
- The remote controller will not function if there are obstacles between it and the remote control sensor.
- Do not place objects such as books on top of the remote controller. Doing so could depress the buttons on the remote continually and drain the batteries.

Connecting to Other Devices

Connect to playback components, recording devices, and other equipment. There are two ways of connecting: analog and digital. Select the connection type matching the type of audio you wish to enjoy.

! Caution

Do not place the unit in a location subject to vibration.

Precautions for Making Connections

Color Coding for Audio Connections

- Take care of the plug colors and the left and right channels when connecting audio.

Left (white)  Right (red) 

- Insert plugs completely to ensure good connections. Loose connections can cause noise or malfunctions.

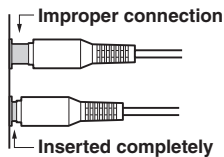

- To prevent interference, keep audio cables away from power cords and speaker cables.

Digital Connections

There are two types of digital audio in terminal: "OPTICAL" and "COAXIAL". Use the correct terminals and cables for the device to connect.

Connecting Speakers

- 1 Strip away approx. 5/8 inch (15 mm) of insulation from the ends of the speaker cables, and twist the bare wires tightly.

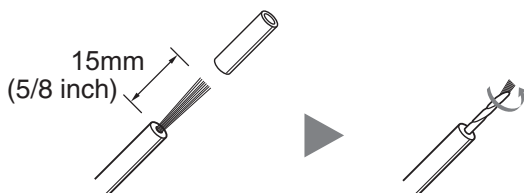

- 2 Loosen the screws on the speaker terminals, insert the wires, and screw the terminals tight.

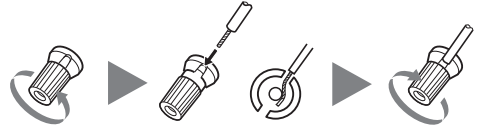

! Caution

- Make sure that the wires do not touch metal parts on the back panel or elsewhere.
- Y plugs cannot be connected.

- 3 Connect the speakers as shown in the drawing. Connect the positive speaker wire ⊕ to the positive terminal on the unit ⊕, and the negative speaker wire ⊖ to the negative terminal on the unit ⊖.

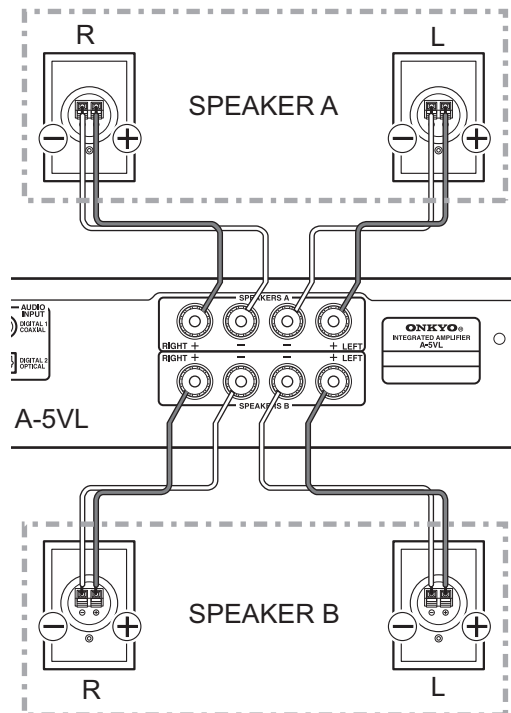

Connecting to Other Devices—Continued

Notes

Two sets of speakers can be connected to the amplifier. You can select which speakers to output audio to when listening to music. You can also output audio from both sets of speakers.

- North American model:

If you only connect one set of speakers (A or B), make sure to use speakers with an impedance of 2 to 16 Ohms.

If you connect both sets of speakers (A and B), make sure to use speakers with an impedance of 4 to 16 Ohms. If you connect speakers with impedance less than 4 Ohms, it may cause the protection circuit to activate.

- Other models:

If you only connect one set of speakers (A or B), make sure to use speakers with an impedance of 4 to 16 Ohms.

If you connect both sets of speakers (A and B), make sure to use speakers with an impedance of 8 to 16 Ohms. If you connect speakers with impedance less than 8 Ohms, it may cause the protection circuit to activate.

Caution

- Take care of the positive \oplus and negative \ominus wires when connecting the left and right speakers. Mixing up the connections will cause the audio to sound unnatural.
- Do not connect more than one speaker wire to a single speaker terminal. Doing so could damage the unit or cause it to malfunction.
- When using only one speaker, or when playing back monaural audio, do not connect a single speaker to both the left and right speaker terminals.

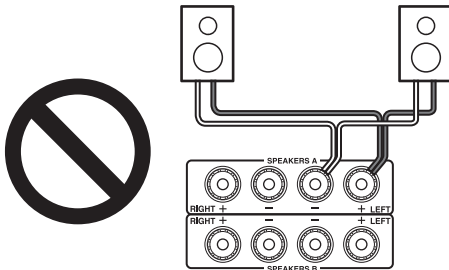

Danger

Never allow the positive and negative speaker wires to touch. Doing so could damage the circuit.

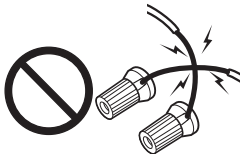

Connecting Audio Components

Connecting a Turntable

- 1 Turn off the unit.
- 2 Use the MM/MC selector on the back of the unit to select either MM or MC, in accordance with the cartridge format of the turntable.

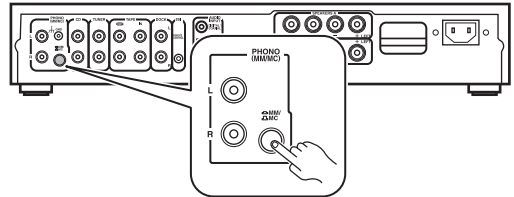

Caution

Always turn off the unit before switching between MM and MC.

- 3 Remove the short pins plugged into the PHONO inputs.
- 4 Connect the unit as shown in the drawing.

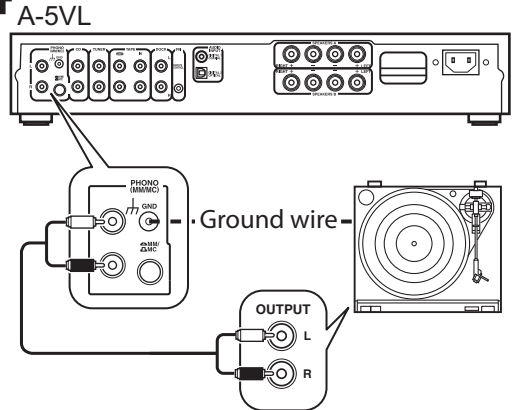

Caution

If the turntable has a ground wire, connect it to the unit's GND screw. Note, however, that for some turntables, connecting the ground wire will increase the noise. If this happens, do not connect the ground wire.

Connecting to Other Devices—Continued

Connecting a Super Audio or Normal CD Player

Connect the CD player's audio outputs to the unit's CD jacks.

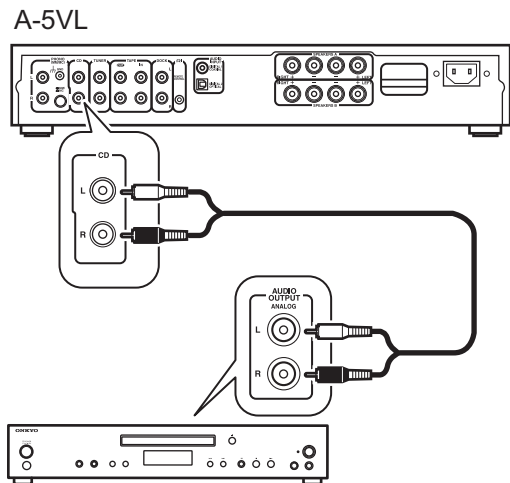

Connecting an AM/FM Tuner

Connect the AM/FM tuner's audio outputs to the unit's TUNER inputs.

RI Any Onkyo AM/FM tuner with the proper terminals can be connected. A connected tuner can be controlled via the unit's remote controller.

Use a **RI** cable to connect the unit's **RI** terminal with the tuner's **RI** terminal.

Connect the unit's audio in terminal with the tuner's audio out terminal.

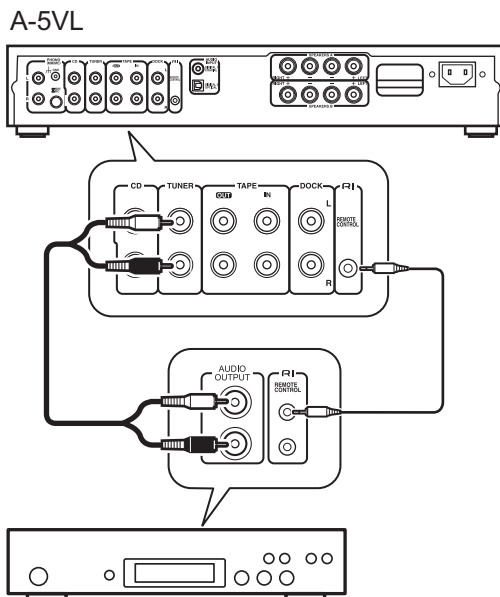

! Caution

- Be sure to connect the audio cable when using an **RI** connection.
- The tuner's timer feature is not available when using an **RI** connection.

Connecting a Cassette or MiniDisc Recorder

Connect the audio outputs of the cassette or MiniDisc Recorder (PLAY) to the unit's TAPE IN jacks. Connect the audio inputs of the cassette or MiniDisc Recorder (REC) to the unit's TAPE OUT jacks.

A-5VL

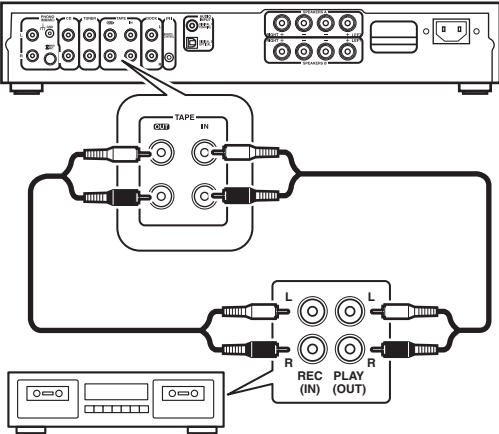

Connecting an RI Dock

You can connect an Onkyo RI dock to the unit.

- 1 Connect the RI dock's AUDIO OUT to the unit's DOCK jack. Connect the RI dock and unit's RI jacks via the RI cable.

A-5VL

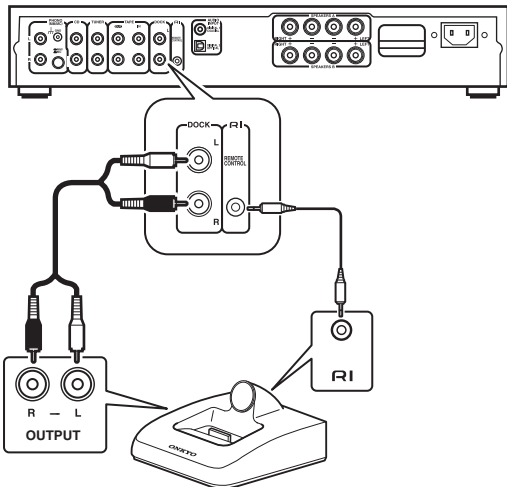

(The drawing shows a DS-A3 Onkyo RI dock being connected.)

- 2 Set the RI dock's RI MODE selector to "HDD" or "HDD/DOCK".
- 3 Set the unit's input selector to "DOCK".

Notes

Refer to the RI dock's manual for details.

Connecting a Digital Playback Component (OPTICAL)

Connect the component using a commercial optical digital cable.

Notes

- The unit supports 16/24 bit, 32/44.1/48/96 kHz PCM signal digital input.
- Inputting an incompatible signal may result in noise.
- When an unsupported signal is detected, the unit's LOCKED indicator illuminates.
- Do not input a DTS-CD digital audio signal.

A-5VL

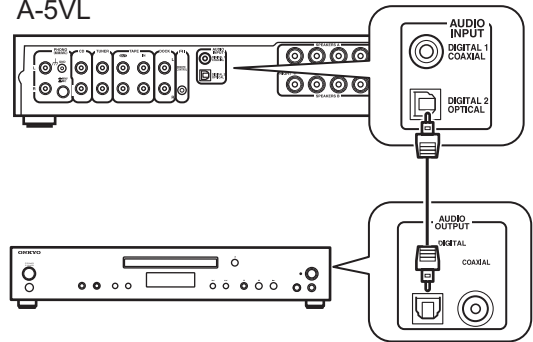

! Caution

Plug optical digital cables straight in and out. Plugging them in and out at an angle can damage the inlet of the OPTICAL terminal.

Connecting a Digital Playback Component (COAXIAL)

Connect the component using a commercial coaxial digital cable.

Notes

- The unit supports 16/24 bit, 32/44.1/48/96 kHz PCM signal digital input.
- Inputting an incompatible signal may result in noise.
- When an unsupported signal is detected, the unit's LOCKED indicator illuminates.
- Do not input a DTS-CD digital audio signal.

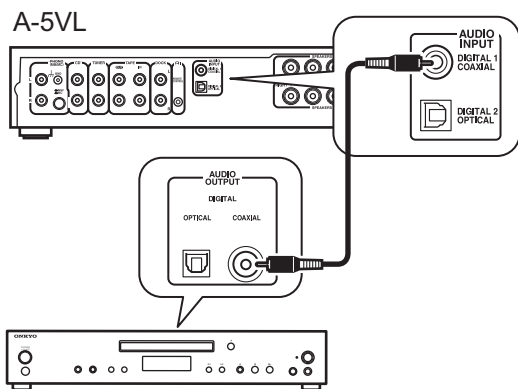

Connecting the Power Cord

! Caution

- Before connecting the power cord, connect all the other components.
- Turn off the unit before plugging or unplugging the power cord.

- 1 Connect the other components. (See p.10)
- 2 Make sure that the unit is turned off.
- 3 Connect the supplied power cord to the unit's AC INLET.

! Caution

- Always use the supplied power cord.
- Never plug the power cord into the outlet before connecting it to the unit. If the power cord is plugged in, connecting or disconnecting it to/from the unit could cause electric shock.

- 4 Plug the power cord into a household power outlet.

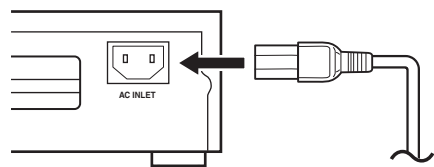

To AC wall outlet

Notes

The unit manages the power polarity. To enjoy better audio, insert the prong of the plug with a blade marking into the outlet hole with the longer slit.

If the left and right slits are the same length, then the orientation of the plug does not matter.

! Caution

Always unplug the power cord from the outlet before disconnecting it from the unit.

Enjoying Audio Sources (Operating the Unit)

1 Turn on the component connected to the unit.

2 Press the **POWER** button on the front of the unit to turn it on.

The **POWER** indicator illuminates.

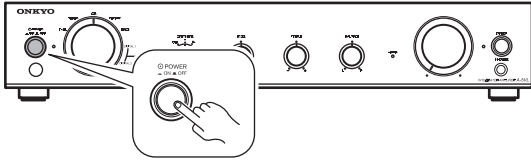

Notes

- Audio output will not begin until the electrical circuit stabilizes.
- Audio quality will stabilize about 10 to 30 minutes after the unit is turned on.

3 Turn the **input selector control** to select the **audio playback component**.

Audio is output from the component connected to the selected terminal.

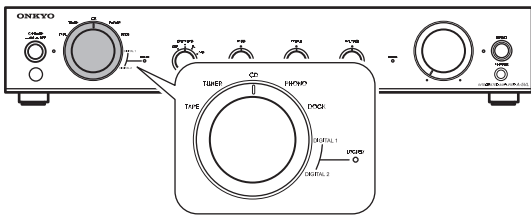

4 Turn the **SPEAKERS** control to select the **audio-output speakers**.

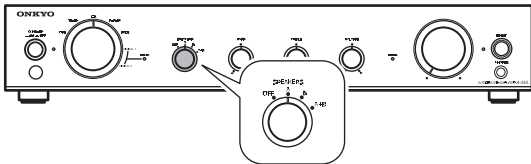

- OFF:** Do not output audio from the speakers connected to the **SPEAKERS** terminals.
- A:** Output audio from the speakers connected to **SPEAKERS** terminal A.
- B:** Output audio from the speakers connected to **SPEAKERS** terminal B.
- A+B:** Output audio from the speakers connected to **SPEAKERS** terminals A and B.

5 Start playback on the component selected in step three.

6 Turn the **VOLUME** control to adjust the volume.

You can also control the volume using the volume buttons on the remote controller.

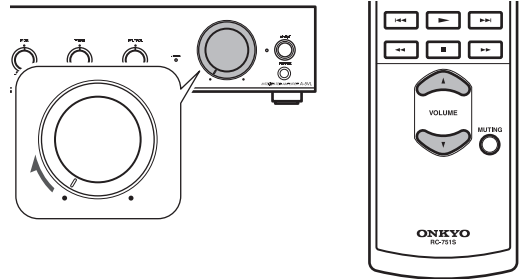

Notes

- Press the **MUTING** button on the remote controller to set the volume to the minimum level. When the volume is muted, the **MUTING** indicator illuminates. Press the **MUTING** button again to restore the original volume. Mute mode will also be canceled by adjusting the volume or pressing the **POWER** button.
- To listen with headphones, turn down the volume, and then insert the headphone plug into the **PHONES** jack. When the headphones are plugged in, audio will not be output from the speakers.

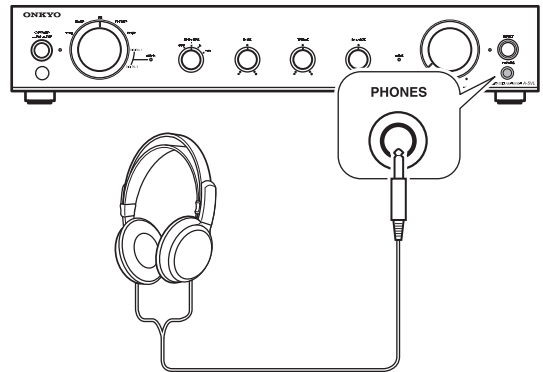

Adjusting the Tone and Left/Right Volume Balance

- 1 Press the **DIRECT** button on the front of the unit to turn it off.

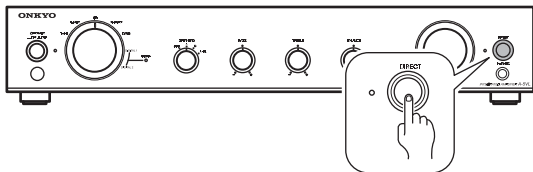

DIRECT off: Audio adjusted via the unit's BASS, TREBLE, and BALANCE controls is output.

DIRECT on: Audio is output directly, without passing through the BASS, TREBLE, and BALANCE tone control circuits.

- 2 Turn the **BASS** control to adjust the bass. Turn the **TREBLE** control to adjust the treble. Turn the **BALANCE** control to adjust the volume balance output from the left and right speakers.

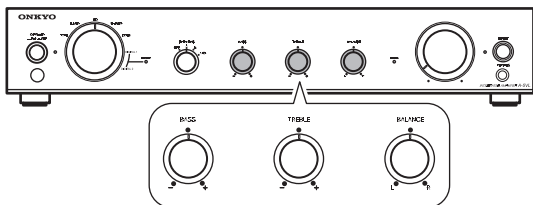

Notes

- Turn the BASS and TREBLE controls to the right to increase the bass and treble, respectively.
- Although you can adjust the left and right volume using the BALANCE control, turning it all the way to the right or left will only reduce the volume from that speaker; it will not set the volume to zero.
- The controls should normally be kept in the center position.

Recording

This section describes how to record audio when both a playback component and recording component are connected to the unit.

Notes

Manual tone adjustments using the BASS, TREBLE, and BALANCE controls are not reflected.

! Caution

Unless you have the full consent of the copyright holder, copyright laws prohibit using your recordings for anything other than personal enjoyment!

- 1 Turn the input selector control on the front of the unit to select the audio playback component.

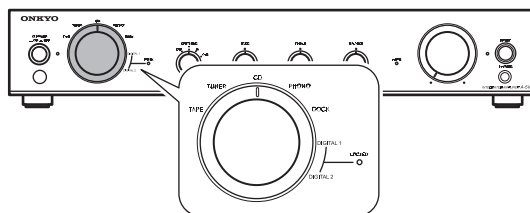

- 2 Place the recording component into recording standby.

Notes

See the manual of the recording component for instructions on correct use.

- 3 Start playback on the playback component. Start recording on the recording component.

! Caution

Do not move the unit's input selector while recording. Doing so will cause the audio from the selected component to be recorded.

Troubleshooting

If you run into problems with the unit, look for a solution below. The problem could also be caused by one of the components connected to the unit, so please also check the manuals of each device.

! Caution

- **This unit contains a sophisticated microcomputer for signal processing and control functions. In very rare situations, however, severe interference, noise from an external source, or static electricity may cause it to lock up. If this happens, turn off the unit, wait for about five seconds, and then turn it on again.**
- **Onkyo is not responsible for damages (such as CD rental fees) due to unsuccessful recordings caused by the unit's malfunction. Before you record important data, make sure that the material will be recorded correctly.**

Power

Problem	Solution	See Page
No power	Make sure that the power cord is properly plugged into the wall outlet. Also make sure that the power cord is properly connected to the unit's AC inlet.	14
	Unplug the power cord from the wall outlet, wait at least five seconds, and then plug it into the outlet again.	
The power is turned off, and the power indicator is flashing	The protection circuit may have been activated. Unplug the power cord from the wall outlet and contact your Onkyo dealer.	

Audio

Problem	Solution	See Page
There is no sound	Make sure that the cables are connected correctly.	10
	Make sure that the component's input and output terminals are matched correctly.	
	Make sure that the speaker cable's positive and negative plugs are connected correctly, and that the speaker wires are fixed securely to the metal portion of the unit's speaker screws.	10
	Make sure that the input device is selected correctly.	15
	If the muting indicator is lighted up, cancel mute mode by pressing the muting button on the remote controller.	15
	Select MM or MC in accordance with the turntable type.	11
There is no audio output from a digitally connected component	Make sure that none of the cables are kinked or damaged.	
	Make sure that the digital audio signal's format is supported.	13
Noise in the audio	Do not bundle audio cables with power cords and the like, because doing so may degrade audio performance.	
	An audio cable may be picking up interference. Try repositioning your cables.	

Remote controller

Problem	Solution	See Page
The remote controller does not work	Make sure that the batteries are installed with the correct polarity.	5
	Install two new batteries.	5
	Make sure that the remote controller is not too far away from the unit, and that there is no obstruction between the unit and the remote controller.	9
	Make sure that the unit's remote control sensor is not exposed to bright light (inverted fluorescent light or direct sunlight).	9
	Make sure that the audio rack does not have colored or tinted glass. Doing so could prevent the remote controller from functioning properly.	9

Recording

Problem	Solution	See Page
Can not record	Make sure that the correct input is selected on the recorder (e.g. digital or analog).	

Appendix

Specifications

Rated output Power	: North America 40 watts minimum continuous power per channel, 8 ohm loads, 2 channels driven at 1 kHz, with a maximum total harmonic distortion of 0.8 % (FTC) 100 watts minimum continuous power per channel, 2 ohm loads, 2 channels driven at 1 kHz, with a maximum total harmonic distortion of 0.8 % (FTC) Europe and Taiwan 40 W at 8 ohms, 2 ch driven, 1 kHz, 0.8 % THD (IEC) 80 W at 4 ohms, 2 ch driven, 1 kHz, 0.8 % THD (IEC) China 35 W at 8 ohms, 2 ch driven, 1 kHz, 0.7 % THD (IEC) 60 W at 4 ohms, 2 ch driven, 1 kHz, 0.7 % THD (IEC)
Maximum Output Power	: China and Taiwan 90 W at 4 ohms, 1 kHz, 2 ch driven (JEITA)
Dynamic Power	: 115 W (3 Ω , Front) 90 W (4 Ω , Front) 45 W (8 Ω , Front)
THD (Total Harmonic Distortion)	: 0.08 % (1 kHz 1 W)
Damping Factor	: 60 (Front, 1 kHz, 8 Ω)
Input Sensitivity and Impedance	: 200 mV/33 k Ω (LINE) 2.4 mV/47 k Ω (PHONO MM)
Output Level and Impedance	: 200 mV/2.2 k Ω (REC OUT)
Phono Overload	: 60 mV (MM 1 kHz 0.5 %) 6.0 mV (MC 1 kHz 0.5 %)
Frequency Response	: 5 Hz-60 kHz/+1 dB-3 dB (LINE)
Tone Control	: +14 dB, -14 dB, 100 Hz (BASS) +12 dB, -12 dB, 10 kHz (TREBLE) +0 dB, -12 dB (BALANCE)
Signal to Noise Ratio	: 100 dB (LINE, IHF-A) 65 dB (PHONO, IHF-A)
Speaker Impedance	: North America and Taiwan 2 Ω ~ 16 Ω (A or B), 4 Ω ~ 16 Ω (A + B) Others 4 Ω ~ 16 Ω (A or B), 8 Ω ~ 16 Ω (A + B)
Digital Inputs	: OPTICAL 1 (Rear), COAXIAL 1 (Rear)
Analog Inputs	: PHONO/CD/TUNER/TAPE/DOCK
Analog Outputs	: TAPE
Speaker Outputs	: 2 (A, B)
Phones	: 1
Power Supply	: North America and Taiwan AC 120 V, 60 Hz Others AC 220-240 V, 50/60 Hz
Power Consumption	: North America and Taiwan 110 W Others 75 W
Dimensions (WxHxD)	: 435 x 80 x 340 mm 17-1/8"×3-1/8"×13-3/8"
Weight	: 10.2 kg (22.5 lbs)

Specifications and features are subject to change without notice.

Block Diagram

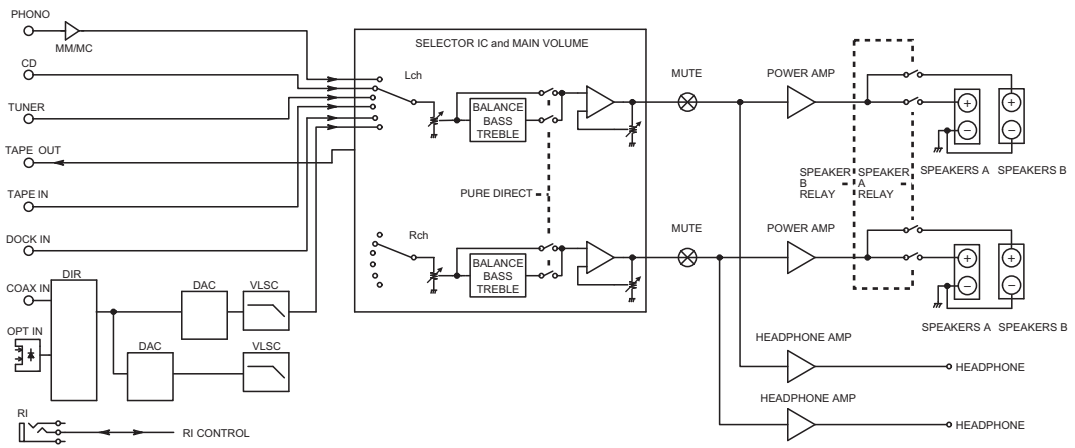

ONKYO CORPORATION

Sales & Product Planning Div. : 2-1, Nisshin-cho, Neyagawa-shi, OSAKA 572-8540, JAPAN
Tel: 072-831-8023 Fax: 072-831-8163

ONKYO U.S.A. CORPORATION

18 Park Way, Upper Saddle River, N.J. 07458, U.S.A.
Tel: 201-785-2600 Fax: 201-785-2650 <http://www.us.onkyo.com/>

ONKYO EUROPE ELECTRONICS GmbH

Liegnitzerstrasse 6, 82194 Groebenzell, GERMANY
Tel: +49-8142-4401-0 Fax: +49-8142-4401-555 <http://www.eu.onkyo.com/>

ONKYO EUROPE UK Office

Suite 1, Gregories Court, Gregories Road, Beaconsfield, Buckinghamshire, HP9 1HQ
UNITED KINGDOM Tel: +44-(0)1494-681515 Fax: +44(0)-1494-680452

ONKYO CHINA LIMITED

Unit 1&12, 9/F, Ever Gain Plaza Tower 1, 88, Container Port Road, Kwai Chung,
N.T., HONG KONG Tel: 852-2429-3118 Fax: 852-2428-9039
<http://www.ch.onkyo.com/>



W0905-1

SN 29400048

(C) Copyright 2009 ONKYO CORPORATION Japan. All rights reserved.



* 2 9 4 0 0 0 4 8 *