

ONKYO®

AV Receiver

TX-SR876

TX-NR906

Instruction Manual

Thank you for purchasing an Onkyo AV Receiver. Please read this manual thoroughly before making connections and plugging in the unit. Following the instructions in this manual will enable you to obtain optimum performance and listening enjoyment from your new AV Receiver. Please retain this manual for future reference.

Contents

Introduction2

Connection23

First Time Setup52

Basic Operation.....70

Using the Listening Modes81

Advanced Setup92

NET/USB (TX-NR906 only).....121

Zone 2 and Zone 3.....130

Controlling Other Components ..137

Others.....142



WARNING:

TO REDUCE THE RISK OF FIRE OR ELECTRIC SHOCK, DO NOT EXPOSE THIS APPARATUS TO RAIN OR MOISTURE.

CAUTION:

TO REDUCE THE RISK OF ELECTRIC SHOCK, DO NOT REMOVE COVER (OR BACK). NO USER-SERVICEABLE PARTS INSIDE. REFER SERVICING TO QUALIFIED SERVICE PERSONNEL.



WARNING
RISK OF ELECTRIC SHOCK
DO NOT OPEN

AVIS
RISQUE DE CHOC ELECTRIQUE
NE PAS OUVRIR



The lightning flash with arrowhead symbol, within an equilateral triangle, is intended to alert the user to the presence of uninsulated "dangerous voltage" within the product's enclosure that may be of sufficient magnitude to constitute a risk of electric shock to persons.



The exclamation point within an equilateral triangle is intended to alert the user to the presence of important operating and maintenance (servicing) instructions in the literature accompanying the appliance.

Important Safety Instructions

1. Read these instructions.
2. Keep these instructions.
3. Heed all warnings.
4. Follow all instructions.
5. Do not use this apparatus near water.
6. Clean only with dry cloth.
7. Do not block any ventilation openings. Install in accordance with the manufacturer's instructions.
8. Do not install near any heat sources such as radiators, heat registers, stoves, or other apparatus (including amplifiers) that produce heat.
9. Do not defeat the safety purpose of the polarized or grounding-type plug. A polarized plug has two blades with one wider than the other. A grounding type plug has two blades and a third grounding prong. The wide blade or the third prong are provided for your safety. If the provided plug does not fit into your outlet, consult an electrician for replacement of the obsolete outlet.
10. Protect the power cord from being walked on or pinched particularly at plugs, convenience receptacles, and the point where they exit from the apparatus.
11. Only use attachments/accessories specified by the manufacturer.
12. Use only with the cart, stand, tripod, bracket, or table specified by the manufacturer, or sold with the apparatus. When a cart is used, use caution when moving the cart/apparatus combination to avoid injury from tip-over.

PORTABLE CART WARNING
S3125A
13. Unplug this apparatus during lightning storms or when unused for long periods of time.
14. Refer all servicing to qualified service personnel. Servicing is required when the apparatus has been damaged in any way, such as power-supply cord or plug is damaged, liquid has been spilled or objects have fallen into the apparatus, the apparatus has been exposed to rain or moisture, does not operate normally, or has been dropped.
15. Damage Requiring Service
Unplug the apparatus from the wall outlet and refer servicing to qualified service personnel under the following conditions:
 - A. When the power-supply cord or plug is damaged,
 - B. If liquid has been spilled, or objects have fallen into the apparatus,
 - C. If the apparatus has been exposed to rain or water,
 - D. If the apparatus does not operate normally by following the operating instructions. Adjust only those controls that are covered by the operating instructions as an improper adjustment of other controls may result in damage and will often require extensive work by a qualified technician to restore the apparatus to its normal operation,
 - E. If the apparatus has been dropped or damaged in any way, and
 - F. When the apparatus exhibits a distinct change in performance this indicates a need for service.
16. Object and Liquid Entry
Never push objects of any kind into the apparatus through openings as they may touch dangerous voltage points or short-out parts that could result in a fire or electric shock.
The apparatus shall not be exposed to dripping or splashing and no objects filled with liquids, such as vases shall be placed on the apparatus.
Don't put candles or other burning objects on top of this unit.
17. Batteries
Always consider the environmental issues and follow local regulations when disposing of batteries.
18. If you install the apparatus in a built-in installation, such as a bookcase or rack, ensure that there is adequate ventilation.
Leave 20 cm (8") of free space at the top and sides and 10 cm (4") at the rear. The rear edge of the shelf or board above the apparatus shall be set 10 cm (4") away from the rear panel or wall, creating a flue-like gap for warm air to escape.

Precautions

1. **Recording Copyright**—Unless it's for personal use only, recording copyrighted material is illegal without the permission of the copyright holder.
2. **AC Fuse**—The AC fuse inside the unit is not user-serviceable. If you cannot turn on the unit, contact your Onkyo dealer.
3. **Care**—Occasionally you should dust the unit all over with a soft cloth. For stubborn stains, use a soft cloth dampened with a weak solution of mild detergent and water. Dry the unit immediately afterwards with a clean cloth. Don't use abrasive cloths, thinners, alcohol, or other chemical solvents, because they may damage the finish or remove the panel lettering.

4. Power

WARNING

BEFORE PLUGGING IN THE UNIT FOR THE FIRST TIME, READ THE FOLLOWING SECTION CAREFULLY.

AC outlet voltages vary from country to country. Make sure that the voltage in your area meets the voltage requirements printed on the unit's rear panel (e.g., AC 230 V, 50 Hz or AC 120 V, 60 Hz).

The power cord plug is used to disconnect this unit from the AC power source. Make sure that the plug is readily operable (easily accessible) at all times.

For North American model

Pressing the [ON/STANDBY] button to select Standby mode does not fully shutdown the unit. If you do not intend to use the unit for an extended period, remove the power cord from the AC outlet.

5. Preventing Hearing Loss

Caution

Excessive sound pressure from earphones and headphones can cause hearing loss.

6. Batteries and Heat Exposure

Warning

Batteries (battery pack or batteries installed) shall not be exposed to excessive heat as sunshine, fire or the like.

7. **Never Touch this Unit with Wet Hands**—Never handle this unit or its power cord while your hands are wet or damp. If water or any other liquid gets inside this unit, have it checked by your Onkyo dealer.

8. Handling Notes

- If you need to transport this unit, use the original packaging to pack it how it was when you originally bought it.
- Do not leave rubber or plastic items on this unit for a long time, because they may leave marks on the case.
- This unit's top and rear panels may get warm after prolonged use. This is normal.
- If you do not use this unit for a long time, it may not work properly the next time you turn it on, so be sure to use it occasionally.

For U.S. models

FCC Information for User

CAUTION:

The user changes or modifications not expressly approved by the party responsible for compliance could void the user's authority to operate the equipment.

NOTE:

This equipment has been tested and found to comply with the limits for a Class B digital device, pursuant to Part 15 of the FCC Rules. These limits are designed to provide reasonable protection against harmful interference in a residential installation.

This equipment generates, uses and can radiate radio frequency energy and, if not installed and used in accordance with the instructions, may cause harmful interference to radio communications. However, there is no guarantee that interference will not occur in a particular installation. If this equipment does cause harmful interference to radio or television reception, which can be determined by turning the equipment off and on, the user is encouraged to try to correct the interference by one or more of the following measures:

- Reorient or relocate the receiving antenna.
- Increase the separation between the equipment and receiver.
- Connect the equipment into an outlet on a circuit different from that to which the receiver is connected.
- Consult the dealer or an experienced radio/TV technician for help.

For Canadian Models

NOTE: THIS CLASS B DIGITAL APPARATUS COMPLIES WITH CANADIAN ICES-003.

For models having a power cord with a polarized plug:

CAUTION: TO PREVENT ELECTRIC SHOCK, MATCH WIDE BLADE OF PLUG TO WIDE SLOT, FULLY INSERT.

Modèle canadien

REMARQUE: CET APPAREIL NUMÉRIQUE DE LA CLASSE B EST CONFORME À LA NORME NMB-003 DU CANADA.

Sur les modèles dont la fiche est polarisée:

ATTENTION: POUR ÉVITER LES CHOCS ÉLECTRIQUES, INTRODUIRE LA LAME LA PLUS LARGE DE LA FICHE DANS LA BORNE CORRESPONDANTE DE LA PRISE ET POUSSER JUSQU'AU FOND.

Precautions—Continued

For British models

Replacement and mounting of an AC plug on the power supply cord of this unit should be performed only by qualified service personnel.

IMPORTANT

The wires in the mains lead are coloured in accordance with the following code:

Blue: Neutral

Brown: Live

As the colours of the wires in the mains lead of this apparatus may not correspond with the coloured markings identifying the terminals in your plug, proceed as follows:

The wire which is coloured blue must be connected to the terminal which is marked with the letter N or coloured black.

The wire which is coloured brown must be connected to the terminal which is marked with the letter L or coloured red.

IMPORTANT

The plug is fitted with an appropriate fuse. If the fuse needs to be replaced, the replacement fuse must be approved by ASTA or BSI to BS1362 and have the same ampere rating as that indicated on the plug. Check for the ASTA mark or the BSI mark on the body of the fuse.

If the power cord's plug is not suitable for your socket outlets, cut it off and fit a suitable plug. Fit a suitable fuse in the plug.

For European Models

Declaration of Conformity	
We, ONKYO EUROPE ELECTRONICS GmbH LIEGNITZERSTRASSE 6, 82194 GROEBENZELL, GERMANY	
declare in own responsibility, that the ONKYO product described in this instruction manual is in compliance with the corresponding technical standards such as EN60065, EN55013, EN55020 and EN61000-3-2, -3-3.	
GROEBENZELL, GERMANY	 K. MIYAGI
ONKYO EUROPE ELECTRONICS GmbH	

Contents

Features	6	Basic Operations	70
Supplied Accessories	7	Selecting the Input Source	70
Multiroom Capability	8	Setting the Display Brightness	71
Front & Rear Panels	9	Adjusting Speaker Levels	71
Front Panel	9	Muting the AV Receiver	71
Display	11	Using the Sleep Timer	72
Rear Panel	12	Using Headphones	72
Remote Controller	15	Adjusting the Bass & Treble	72
Installing the Batteries	15	Displaying Source Information	72
Aiming the Remote Controller	15	Listening to the Radio	73
About the Remote Controller Modes	16	Listening to AM/FM Stations	73
RECEIVER/TAPE Mode	16	Presetting AM/FM Stations	75
DVD Mode	18	Listening to HD Radio™ Stations (North American model only)	76
CD/MD/CDR Modes	19	Using RDS	77
DOCK Mode	20	Recording	80
NET/USB Mode (TX-NR906 only)	21	Recording the Input Source	80
About Home Theater	22	Recording from Different AV Sources	80
Enjoying Home Theater	22	Using the Listening Modes	81
Connecting the AV Receiver	23	Selecting the Listening Modes	81
Connecting Your Speakers	23	Listening Modes Available for Each Source Format	82
Bi-amping Front Speakers A	27	About the Listening Modes	88
Bridging Front Speakers A	28	Advanced Setup	92
Bi-amping Front Speakers B	29	Menu Map	92
Bridging Front Speakers B	30	Monitor Out Setup	93
Connecting Antenna	31	Speaker Setup	95
About AV Connections	33	Audio Adjust	105
Connecting Both Audio & Video	34	Adjust Using the Direct Button	108
Which Connections Should I Use?	34	Using the Re-EQ Function	108
Connecting a TV or Projector	36	Using the Late Night Function	109
Connecting a DVD player	37	Source Setup	109
Connecting a VCR or DVD Recorder for Playback	39	Listening Mode Presets	114
Connecting a VCR or DVD Recorder for Recording	40	Miscellaneous Setup	115
Connecting a Satellite, Cable, Terrestrial Set-top box, or Other Video Source	41	Hardware Setup	117
Connecting Components with HDMI	42	Lock Setup	119
Connecting a Game Console	44	Selecting Audio Inputs	120
Connecting a Camcorder or Other Device	45	Specifying the Digital Signal Format	120
Connecting a CD Player or Turntable	46	NET/USB (TX-NR906 only)	121
Connecting a Cassette, CDR, MiniDisc, or DAT Recorder	47	About NET/USB	121
Connecting a Power Amplifier	48	Connecting the AV Receiver	123
Connecting an RI Dock	49	Playing Music Files on a Server	123
Connecting the Power Cords of Other Components (North American model only)	49	Windows Media Player 11 Setup	124
Connecting Onkyo RI Components	50	Playing Music Files on a USB Device	125
Connecting the Power Cord	50	Listening to Internet Radio	127
Turning On the AV Receiver	51	Network Settings	128
Turning On and Standby	51	Zone 2 and Zone 3	130
First Time Setup	52	Connecting Zone 2	130
Monitor Setup	52	Connecting Zone 3	131
Selecting the Language used for the onscreen setup menus	53	Powered Zone2 Setting	132
Using the Onscreen Setup Menus	54	Zone 2/Zone 3 Out Settings	133
Monitor Out Setup	55	Using Zone 2 and Zone 3	133
Video Input Setup	56	Using the Remote Controller in Zone 2/3 and Multiroom Control Kits	136
Digital Audio Input Setup	59	Controlling Other Components	137
Analog Audio Input Setup	60	Entering Remote Control Codes	137
Speaker Settings	61	Resetting the Remote Controller	138
TV Format Setup (not North American models)	62	Learning Commands	140
AM Frequency Step Setup (on some models)	63	Using Macros	141
Changing the Input Display	63	Troubleshooting	142
Automatic Speaker Setup (Audyssey MultEQ® XT)	64	Specifications (TX-SR876)	148
		Specifications (TX-NR906)	149

Features

Amplifier

- 140 Watts/Channel (2ch Driven) @ 8 ohms (FTC)
- 200 Watts/Channel @ 6 ohms (IEC)
- 250 Watts/Channel @ 6 ohms (JEITA)
- WRAT-Wide Range Amplifier Technology (5 Hz-100 kHz bandwidth)
- VLSC (Vector Linear Shaping Circuitry)
- Parallel Push-Pull Amplifier Design with 3-Step Inverted Darlington Circuitry
- H.C.P.S. (High Current Power Supply) Massive High Power Transformer

Processing

- HDMI Audio and Video Processing (Deep Color, x.v.Color, Lip Sync, DTS^{*1}-HD Master Audio, DTS-HD High Resolution Audio, Dolby TrueHD^{*2}, Dolby Digital Plus, SA-CD and Multi-CH PCM)
- THX Ultra2 Plus^{*3} Certified
- HQV-Reon-VX Video Processing with 1080p Video Upscaling of All Video Sources via HDMI
- Component Video Upconversion
- Burr-Brown 192 kHz/24-bit D/A Converters
- Three-TI (Aureus) 32-Bit DSP Chips
- Neural Surround^{*4}, THX-Neural
- Theater-Dimensional^{*5} virtual surround sound
- DSD Direct
- Re-EQ^{*6} function

Connections

- 4 HDMI^{*7} Inputs and 2 Outputs
- Onkyo **RIHD** for System Control
- 6 Digital Inputs (3 Optical / 3 Coaxial), 1 Output (Optical)
- 5 S-Video Inputs / 2 Outputs
- Component Video Switching (3 Inputs/1 Output)
- Banana Plug-Compatible Speaker Posts^{*8}
- Powered Zone 2 and Zone 2 and Zone 3 Pre Out
- IR Input/Output and 12 V Trigger
- RS232 Port for Interface Control
- Bi-Amping and BTL Capability

Miscellaneous

- SIRIUS Ready^{*9} / XM Ready^{*10} with XMHD Surround (North American models only)
- HD Radio^{*11} reception (North American models only)
- 40 SIRIUS/XM/AM/FM Presets (North American models)
- 40 AM/FM Presets (European and Asian models)

- Audyssey MultEQ[®] XT^{*12} to Correct Room Acoustic Problems
- Audyssey Dynamic EQ[™]*12 Loudness Correction
- Audyssey Dynamic Volume[™]*12
- Independent Crossover Adjustment (40/50/60/70/80/90/100/120/150/200 Hz)
- Music Optimizer^{*13} for Compressed Music Files
- ISF (Imaging Science Foundation) Video Calibration
- Newly Designed GUI for System Set-up
- Compatible with RI Dock for iPod
- Preprogrammed **RI**-Compatible Remote with 3 Macros and Mode-Key LEDs

TX-NR906 Only

- Microsoft Plays For Sure Certified for Windows Vista
- Network Capability for Streaming Audio Files and Internet Radio (vTuner Portal)
- USB Port for a Mass USB Storage Device (Audio Only)

*1 DTS[™] HD Master Audio

Manufactured under license under U.S. Patent #'s: 5,451,942; 5,956,674; 5,974,380; 5,978,762; 6,226,616; 6,487,535 & other U.S. and worldwide patents issued & pending. DTS is a registered trademark and the DTS logos, Symbol, DTS-HD and DTS-HD Master Audio are trademarks of DTS, Inc. ©1996-2007 DTS, Inc. All Rights Reserved.

*2 DOLBY TRUEHD

Manufactured under license from Dolby Laboratories. "Dolby", "Pro Logic" and the double-D symbol are trademarks of Dolby Laboratories.

*3 THX ULTRA 2 PLUS

THX and Ultra2 Plus are trademarks of THX Ltd. THX may be registered in some jurisdictions. All rights reserved. Surround EX is a trademark of Dolby Laboratories. Used with permission.

*4 neural SURROUND THX TECHNOLOGIES

Neural Surround is a trademark owned by Neural Audio Corporation, THX is a trademark of THX Ltd., which may be registered in some jurisdictions. All rights reserved.

*5 Theater-Dimensional

Theater-Dimensional is a trademark of Onkyo Corporation.

*6 Re-Equalization and the "Re-EQ" logo are trademarks of THX Ltd.

*7 HDMI

HDMI, the HDMI logo and High Definition Multimedia Interface are trademarks or registered trademarks of HDMI Licensing, LLC.

Features—Continued

*8 In Europe, using banana plugs to connect speakers to an audio amplifier is prohibited.

*9 **SIRIUS**
R E A D Y

©2005 SIRIUS Satellite Radio Inc. “SIRIUS”, SiriusConnect, the SIRIUS dog logo, channel names and logos are trademarks of SIRIUS Satellite Radio Inc. Available only in the contiguous United States (excluding Alaska and Hawaii) and Canada.

*10 **((XM))**
R E A D Y

XM Ready® is a trademark of XM Satellite Radio Inc. ©2005 XM Satellite Radio Inc. All rights reserved.

*11 **HD Radio**®

HD Radio™ Technology Manufactured Under License From iBiquity Digital Corp. U.S. and Foreign Patents. HD Radio™ and the HD Radio logo are proprietary trademarks of iBiquity Digital Corp.

*12 **AUDYSSEY**
MULTI EQ XT
DYNAMIC EQ
DYNAMIC VOLUME

Manufactured under license from Audyssey Laboratories. U.S. and foreign patents pending. Audyssey MultEQ® XT, Audyssey Dynamic Volume™, and Audyssey Dynamic EQ™ are trademark of Audyssey Laboratories.

*13 Music Optimizer™ is a trademark of Onkyo Corporation.

THX Ultra2 Plus

Before any home theater component can be THX Ultra2 Plus certified, it must pass a rigorous series of quality and performance tests. Only then can a product feature the THX Ultra2 Plus logo, which is your guarantee that the Home Theater products you purchase will give you superb performance for many years to come. THX Ultra2 Plus requirements define hundreds of parameters, including power amplifier performance, and pre-amplifier performance and operation for both digital and analog domains. THX Ultra2 Plus receivers also feature proprietary THX technologies (e.g., THX Mode) which accurately translate movie soundtracks for home theater playback.

- * “Xantech” is a registered trademark of Xantech Corporation.
- * “Niles” is a registered trademark of Niles Audio Corporation.
- * Apple and iPod are trademarks of Apple Inc., registered in the U.S. and other countries.
- * “x.v.Color” is a trademark of Sony Corporation.

This product incorporates copyright protection technology that is protected by U.S. patents and other intellectual property rights. Use of this copyright protection technology must be authorized by Macrovision Corporation, and is intended for home and other limited consumer uses only unless otherwise authorized by Macrovision. Reverse engineering or disassembly is prohibited.

Supplied Accessories

Make sure you have the following accessories:

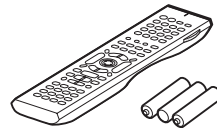

Remote controller and three batteries (AA/R6)



Speaker setup microphone



Indoor FM antenna

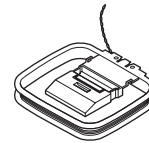

AM loop antenna

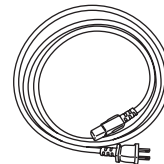

Power cord
(Power cord varies from country to country.)

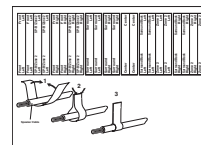

Speaker cable labels

- * In catalogs and on packaging, the letter at the end of the product name indicates the color. Specifications and operation are the same regardless of color.

Multiroom Capability

You can use four speaker systems with this AV receiver—*Speakers A*: a surround-sound speaker system (up to 7.1 channels) for enjoying DVD movies in your main room, *Speakers B*: a pair of stereo speakers for serious music listening in your main room, *Zone 2*: a stereo speaker system in a second room, *Zone 3*: a stereo speaker system in a third room. And, you can select a different audio source for each room.

Speakers A: Enjoy up to 7.1-channel surround-sound playback (see page 23).

You can enjoy the various listening modes, such as Dolby, DTS, and THX (see pages 81–91).

*While Powered Zone 2 is being used, playback is reduced to 5.1-channels (see page 130).

Speakers B: Use a pair for stereo speakers for serious music listening in main room (see page 23).

*Can be used with the subwoofer, center, surround, or surround back speakers as required (see page 98).

Zone 2: Enjoy 2-channel stereo playback and video playback in a second room (see page 130).

*The listening modes cannot be used with Zone 2 and Zone 3.

*External power amplifier required if Speakers B is used.

Zone 3: Enjoy 2-channel stereo playback in a third room (see page 131).

*The listening modes cannot be used with Zone 2 and Zone 3.

*External power amplifier required.

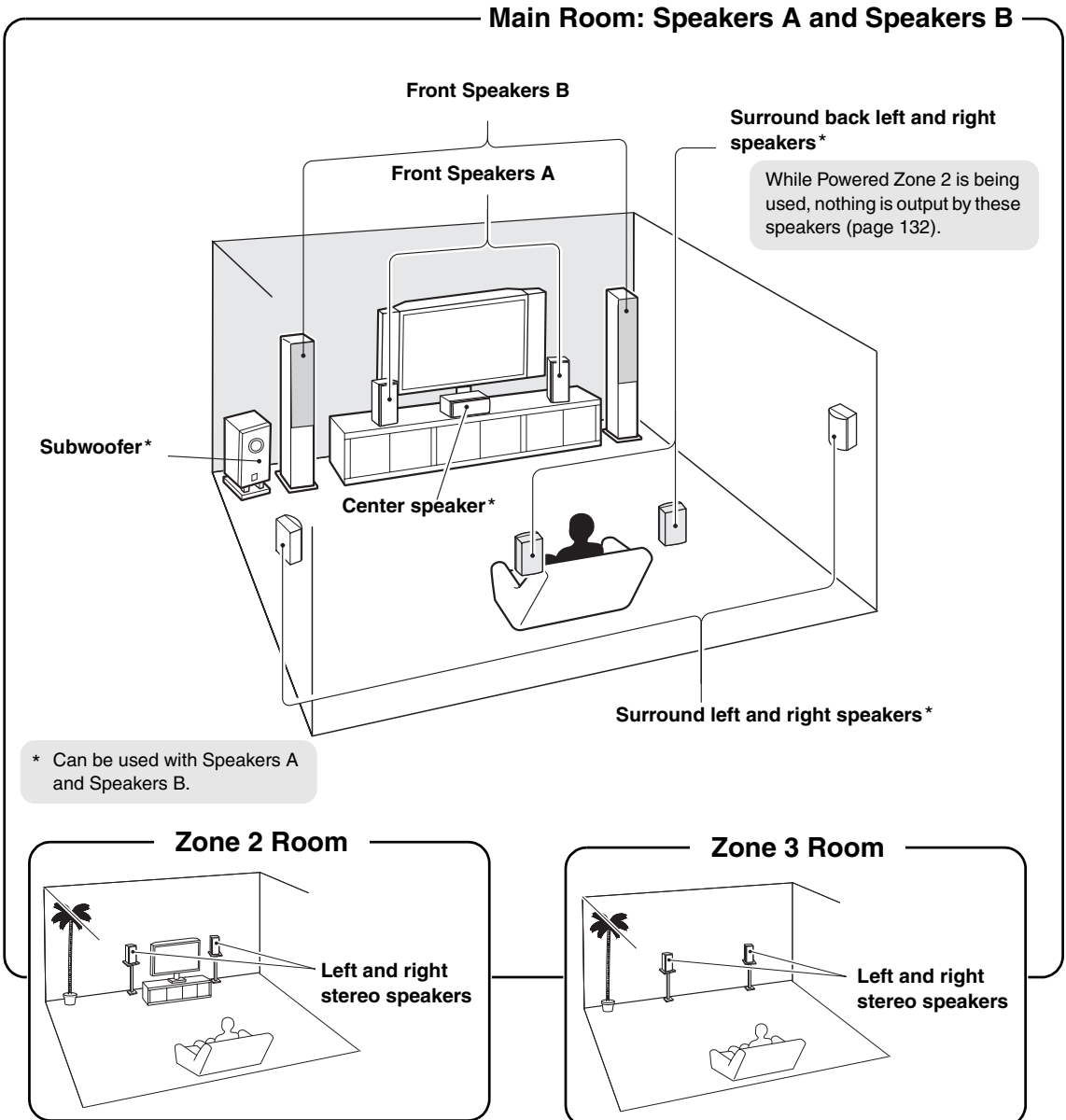

Front & Rear Panels

Front Panel

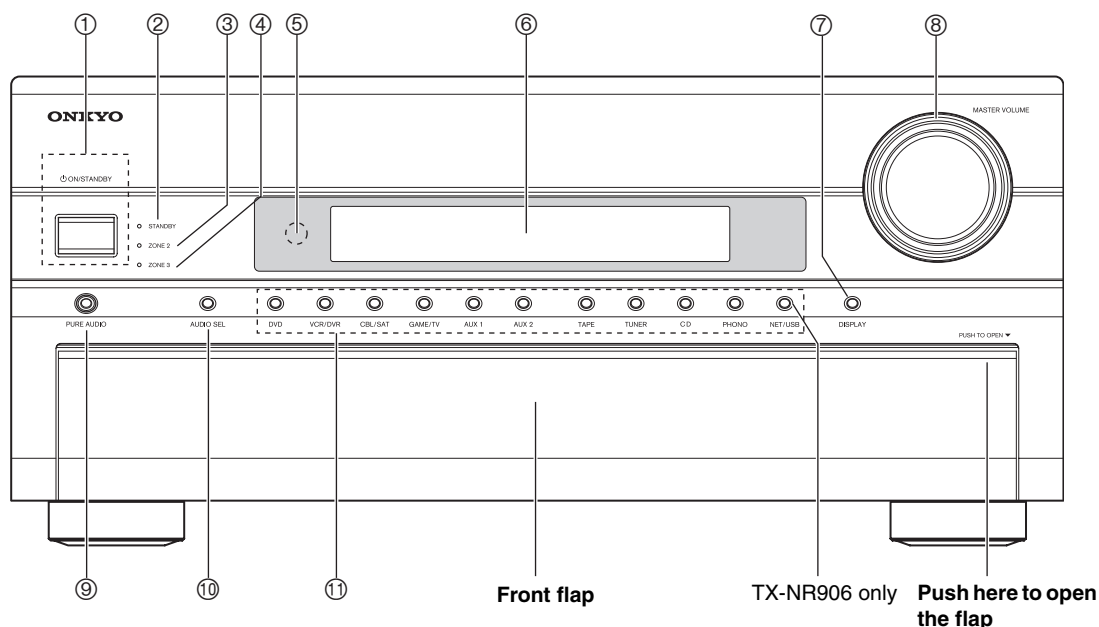

The actual front panel has various logos printed on it. They are not shown here for clarity.

The page numbers in parentheses show where you can find the main explanation for each item.

- ① **ON/STANDBY button (51)**
Sets the AV receiver to On or Standby.
- ② **STANDBY indicator (51)**
Lights up when the AV receiver is on Standby and flashes while a signal is being received from the remote controller.
- ③ **ZONE 2 indicator (134)**
This indicator lights up when Zone 2 is selected.
- ④ **ZONE 3 indicator (134)**
This indicator lights up when Zone 3 is selected.
- ⑤ **Remote-control sensor (15)**
Receives control signals from the remote controller.
- ⑥ **Display**
See “Display” on page 11.
- ⑦ **DISPLAY button (72)**
Displays various information about the currently selected input source.
- ⑧ **MASTER VOLUME control (70) and indicator**
Sets the volume of the AV receiver to $-\infty$ dB, -81.5 dB through $+18.0$ dB (relative display).
The volume level can also be displayed as an absolute value. See “Volume Setup” on page 115.
- ⑨ **PURE AUDIO button and indicator (81)**
Selects the Pure Audio listening mode. The indicator lights up when this mode is selected. Pressing this button again selects the previous listening mode.
- ⑩ **AUDIO SEL button (120)**
Selects the audio input: analog, digital, HDMI, or multichannel.
- ⑪ **Input selector buttons (70)**
Select the following input sources: DVD, VCR/DVR, CBL/SAT, GAME/TV, AUX 1, AUX 2, TAPE, TUNER, CD, PHONO, NET/USB (TX-NR906 only).

North American model

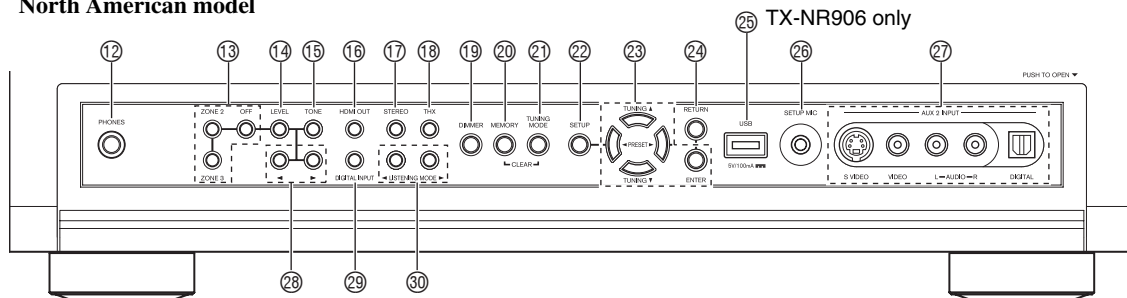

Other models

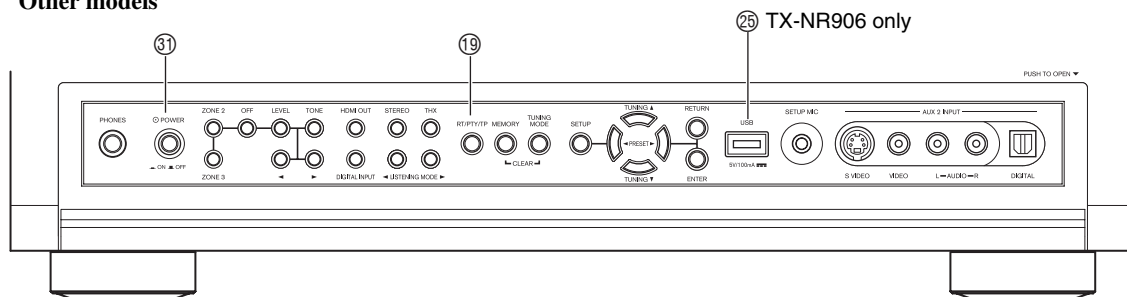

The page numbers in parentheses show where you can find the main explanation for each item.

12 PHONES jack (72)

This 1/4-inch phone jack is for connecting a standard pair of stereo headphones for private listening.

13 ZONE 2, ZONE 3, and OFF buttons (134)

The ZONE 2 button is used when setting Zone 2.
The ZONE 3 button is used when setting Zone 3.
The OFF button is used to turn off Zone 2 or Zone 3.

14 LEVEL button (135)

Used when adjusting the volume level of Zone 2 or Zone 3.

15 TONE button (135)

Used to adjust the tone (bass and treble).

16 HDMI OUT button (55)

Used to set the “Monitor Out” setting.

17 STEREO button (81)

Selects the Stereo listening mode.

18 THX button (81)

Selects the THX listening modes.

19 DIMMER (RT/PTY/TP) button (71, 78)

This button is used to adjust the display brightness.
Other models, this is the [RT/PTY/TP] button, and it’s for RDS (Radio Data System). See “Using RDS” on page 77.

20 MEMORY button (75)

Used when storing or deleting radio presets.

21 TUNING MODE button (73)

Selects the Auto or Manual tuning mode.

22 SETUP button

This button is used to access the onscreen setup menus that appear on the connected TV.

23 TUNING, PRESET, Arrow, and ENTER buttons

When the AM or FM input source is selected, the TUNING [▲]/[▼] buttons are used to tune the tuner, and the PRESET [◀]/[▶] buttons are used to select radio presets (see page 75).

When the onscreen setup menus are used, they work as arrow buttons and are used to select and set items. The [ENTER] button is also used with the onscreen setup menus.

24 RETURN button

Selects the previously displayed onscreen setup menu.

25 USB port (TX-NR906 only)

A USB mass storage device, such as a USB flash drive or MP3 player, containing music files (MP3, WMA, WAV, AAC) can be plugged in here and the music selected and played through the AV receiver.

26 SETUP MIC (64)

The included speaker setup microphone is connected here for automatic speaker setup.

27 AUX 2 INPUT (45, 80)

Used to connect a camcorder, game console, and so on. There are input jacks for optical digital audio, S-Video, composite video, and analog audio.

Front & Rear Panels—Continued

- 28 **Up [▶] and Down [◀] buttons (106, 135)**
Used to adjust the tone, and the volume and balance of Zone 2 and Zone 3.
- 29 **DIGITAL INPUT button (64)**
Used to assign digital inputs to input selectors.

- 30 **LISTENING MODE [◀]/[▶] buttons (81)**
Select the Onkyo original listening modes.
- 31 **POWER switch (51)**
American models do not have this switch.
This is the main power switch. When set to OFF, the AV receiver is completely shutdown. It must be set to ON to set the AV receiver to On or Standby.

Display

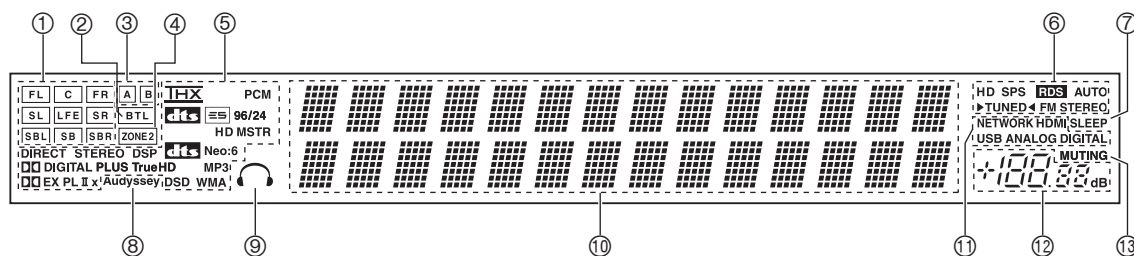

For detailed information, see the pages in parentheses.

- 1 **Speaker/channel indicators (88)**
Indicate the speaker configuration and channels used by the current input source.
: A box is displayed for each speaker that's set in the Speaker Configuration. No box appears for speakers that are set to No or None.
The following abbreviations indicate which audio channels are included in the current input signal.
- FL:** Front left
 - C:** Center
 - FR:** Front right
 - SL:** Surround left
 - LFE:** Subwoofer (Low Frequency Effects)
 - SR:** Surround right
 - SBL:** Surround back left
 - SB:** Surround back
 - SBR:** Surround back right
- 2 **BTL indicator (61)**
Lights up when the "Speaker Type" setting is set to "BTL" for bridged front speaker operation.
- 3 **A and B indicators (70)**
Indicate which speaker set is selected: A or B.
- 4 **ZONE 2 indicator (134)**
Lights up when Powered Zone 2 is being used.
- 5 **Listening mode and format indicators (81)**
Show the selected listening mode and audio input signal format.
- 6 **Tuning indicators (73)**
- HD (North American model only) (76):** Lights up if the current AM or FM station supports HD Radio technology.
 - SPS (North American model only) (79):** Lights up when tuned to a HD Radio station that's transmitting secondary multicast channels.
 - RDS (77):** Lights up when tuned to a radio station that supports RDS (Radio Data System).
 - AUTO (73):** Lights up when Auto Tuning mode is selected for AM or FM radio. Goes off when Manual Tuning mode is selected.
 - TUNED (73):** Lights up when tuned to a radio station.
 - FM STEREO (73):** Lights up when tuned to a stereo FM station.
- 7 **SLEEP indicator (72)**
Lights up when the Sleep function has been set.
- 8 **Audyssey indicator (64)**
Flashes during automatic speaker setup. Lights up when the "Equalizer Settings" is set to "Audyssey".
- 9 **Headphone indicator (72)**
Lights up when a pair of headphones are plugged into the PHONES jack.
- 10 **Message area**
Displays various information.

Front & Rear Panels—Continued

⑪ Audio input indicators (76, 120)

Indicate the type of audio input that's selected as the audio source: HDMI, ANALOG, or DIGITAL.

While a digital HD Radio transmission is being received, the DIGITAL indicator lights up. While an analog HD Radio transmission is being received, the ANALOG indicator lights up.

⑫ Volume level (70)

Displays the volume level.

⑬ MUTING indicator (71)

Flashes while the AV receiver is muted.

Rear Panel

North American model

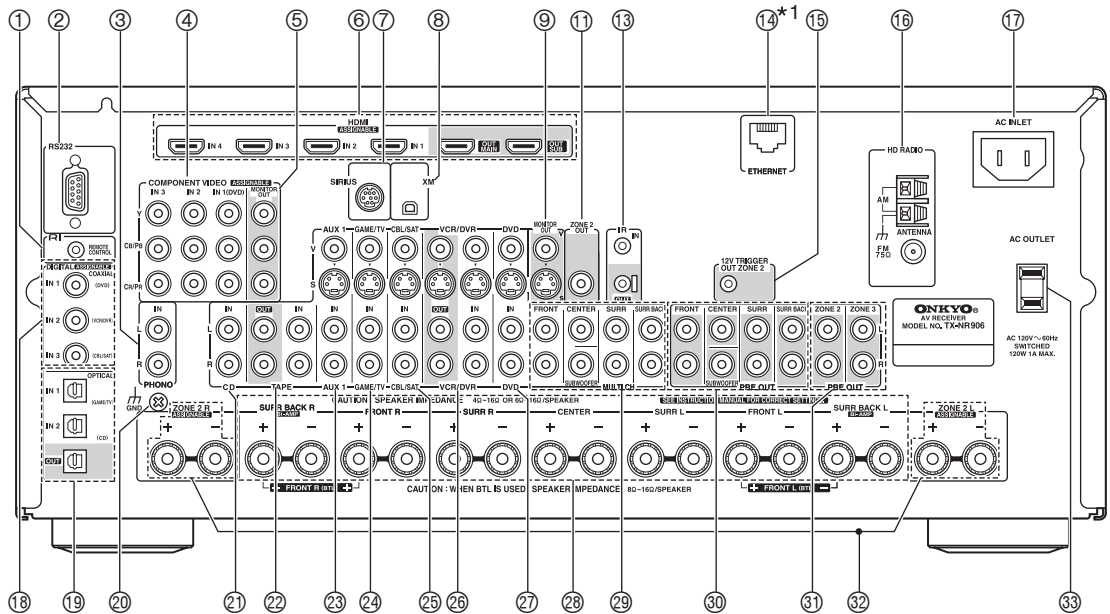

*1 TX-NR906 only

Other models

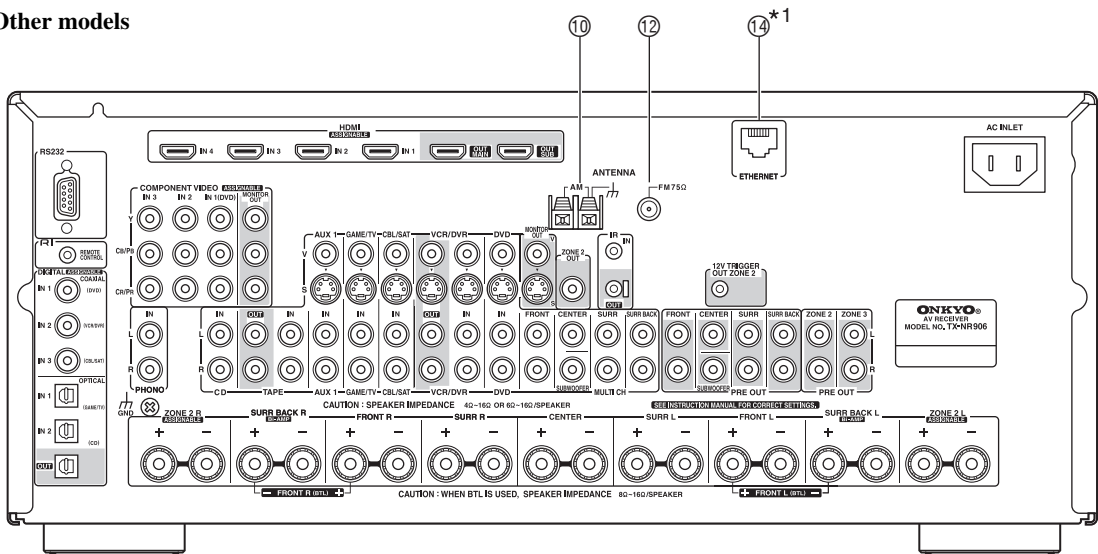

① **RI REMOTE CONTROL**

This **RI** (Remote Interactive) jack can be connected to the **RI** jack on another **RI**-capable Onkyo component for remote and system control.

To use **RI**, you must make an analog audio connection (RCA) between the AV receiver and the other component, even if they are connected digitally.

② **RS232**

③ **PHONO IN**

This audio input is for connecting a turntable.

④ **COMPONENT VIDEO IN 1, 2, and 3**

These RCA component video inputs are for connecting components with a component video output, such as a DVD player, DVD recorder, or DVR (digital video recorder). They're assignable, which means you can assign each one to an input selector to suit your setup. See "Component Video Setup" on page 58.

⑤ **COMPONENT VIDEO MONITOR OUT**

This RCA component video output is for connecting a TV or projector with a component video input.

⑥ **HDMI IN 1–4, OUT MAIN, and OUT SUB**

HDMI (High Definition Multimedia Interface) connections carry digital audio and digital video.

The HDMI inputs are for connecting components with an HDMI output, such as a DVD player, DVD recorder, or DVR (digital video recorder). They're assignable, which means you can assign each one to an input selector to suit your setup. See "Video Input Setup" on page 56.

The HDMI outputs are for connecting a TV or projector with an HDMI input.

⑦ **SIRIUS antenna (on North American model)**

This jack is for connecting a SIRIUS digital antenna, sold separately (see the separate SIRIUS instructions).

⑧ **XM antenna (on North American model)**

This jack is for connecting an XM Mini-Tuner and Home Dock, sold separately (see the separate XM instructions).

⑨ **MONITOR OUT**

The S-Video or composite video jack should be connected to a video input on your TV or projector.

⑩ **AM ANTENNA (not North American model)**

These push terminals are for connecting an AM antenna.

⑪ **ZONE 2 OUT**

This composite video output can be connected to a video input on a TV in Zone 2.

⑫ **FM ANTENNA (not North American model)**

This jack is for connecting an FM antenna.

⑬ **IR IN/OUT**

A commercially available IR receiver can be connected to the IR IN jack, allowing you to control the AV receiver while you're in Zone 2, or control it when it's out of sight, for example, installed in a cabinet.

A commercially available IR emitter can be connected to the IR OUT jack to pass IR (infrared) remote control signals through to other components.

⑭ **ETHERNET port (TX-NR906 only)**

This port is for connecting the AV receiver to your Ethernet network (e.g., router or switch) for playing music files on a networked computer or media server, or for listening to Internet radio.

⑮ **12V TRIGGER OUT ZONE 2**

This output can be connected to the 12-volt trigger input on a component in Zone 2. When Zone 2 is turned on, a 12-volt trigger signal is output.

⑯ **AM and FM ANTENNA (HD Radio reception) (on North American model)**

The AM push terminals are for connecting an AM antenna. The FM jack is for connecting an FM antenna.

⑰ **AC INLET**

The supplied power cord is connected here. The other end of the power cord should be connected to a suitable wall outlet.

⑱ **DIGITAL COAXIAL IN 1, 2, and 3**

These coaxial digital audio inputs are for connecting components with a coaxial digital audio output, such as a CD player or DVD player. They're assignable, which means you can assign each one to an input selector to suit your setup. See "Digital Audio Input Setup" on page 59.

⑲ **DIGITAL OPTICAL IN 1, 2, and OUT**

These optical digital audio inputs are for connecting components with an optical digital audio output, such as a CD player or DVD player. They're assignable, which means you can assign each one to an input selector to suit your setup. See "Digital Audio Input Setup" on page 59.

The optical digital audio output is for connecting a digital recorder with an optical digital input, such as a CD recorder.

⑳ **GND screw**

This screw is for connecting a turntable's ground wire.

㉑ **CD IN**

This analog audio input is for connecting a CD player's analog audio output.

22 **TAPE IN/OUT**

These analog audio input and output jacks are for connecting a recorder with an analog audio input and output, such as a cassette deck, MD recorder, etc.

23 **AUX 1 IN**

A VCR for playback only or other video source can be connected here. There's S-Video and composite video input jacks for connecting the video signal.

24 **GAME/TV IN**

A game console or TV output can be connected here. There's S-Video and composite video input jacks for connecting the video signal.

25 **CBL/SAT IN**

A cable or satellite receiver can be connected here. There's S-Video and composite video input jacks for connecting the video signal.

26 **VCR/DVR IN/OUT**

A video component, such as a VCR or DVR, can be connected here for recording and playback. There's S-Video and composite video input and output jacks for connecting the video signal.

27 **DVD IN**

This input is for connecting a DVD player. There's S-Video and composite video input jacks for connecting the video signal.

28 **FRONT L/R, CENTER, SURR L/R, and SURR BACK L/R speakers**

These terminal posts are for connecting the front Speakers A, center, surround, and surround back speakers.

The FRONT L/R and SURR BACK L/R terminal posts can be used with front Speakers A and surround back speakers, respectively, or used to bi-amp or bridge front Speakers A. See "Bi-amping Front Speakers A" on page 27 and "Bridging Front Speakers A" on page 28.

29 **MULTI CH input: FRONT L/R, CENTER, SUBWOOFER, SURR L/R, and SURR BACK L/R**

This analog multichannel input is for connecting a component with a 5.1/7.1-channel analog audio output, such as a DVD player, DVD-Audio or SACD-capable player, or an MPEG decoder.

30 **PRE OUT: FRONT L/R, CENTER, SUBWOOFER, SURR L/R, and SURR BACK L/R**

This 5.1/7.1 multichannel analog audio output can be connected to the analog audio input on a multichannel power amplifier for when you want to use the AV receiver solely as a preamplifier. The SUBWOOFER jack is for connecting a powered subwoofer.

31 **PRE OUT: ZONE 2, ZONE 3 L/R**

These analog audio outputs can be connected to the line inputs on amplifiers in Zone 2 and Zone 3.

32 **ZONE 2 L/R speakers**

These terminal posts are for connecting speakers in Zone 2 or front Speakers B.

The ZONE 2 L/R and SURR BACK L/R terminal posts can be used with front Speakers B and surround back speakers, respectively, or used to bi-amp or bridge front Speakers B. See "Bi-amping Front Speakers A" on page 27 and "Bridging Front Speakers A" on page 28.

33 **AC OUTLET (North American model only)**

These switched AC outlets can be used to supply power to other AV components. The type and number of outlets depends on the country in which you purchased your AV receiver.

See pages 22–50 for hookup information.

Remote Controller

Installing the Batteries

- 1 To open the battery compartment, press the small hollow and slide open the cover.**

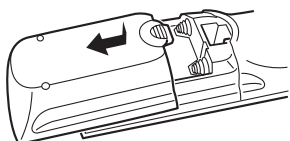

- 2 Insert the three supplied batteries (AA/R6) in accordance with the polarity diagram inside the battery compartment.**

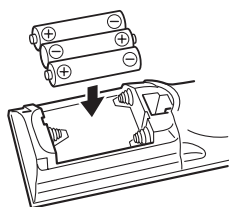

- 3 Slide the cover shut.**

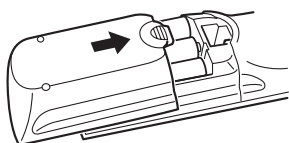

Notes:

- If the remote controller doesn't work reliably, try replacing the batteries.
- Don't mix new and old batteries or different types of batteries.
- If you intend not to use the remote controller for a long time, remove the batteries to prevent damage from leakage or corrosion.
- Expired batteries should be removed as soon as possible to prevent damage from leakage or corrosion.

Aiming the Remote Controller

When using the remote controller, point it toward the AV receiver's remote control sensor, as shown below.

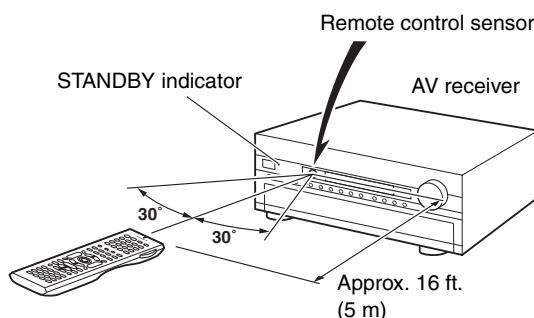

Notes:

- The remote controller may not work reliably if the AV receiver is subjected to bright light, such as direct sunlight or inverter-type fluorescent lights. Keep this in mind when installing.
- If another remote controller of the same type is used in the same room, or the AV receiver is installed close to equipment that uses infrared rays, the remote controller may not work reliably.
- Don't put anything on top of the remote controller, such as a book or magazine, because a button may be pressed continuously, thereby draining the batteries.
- The remote controller may not work reliably if the AV receiver is installed in a rack behind colored glass doors. Keep this in mind when installing.
- The remote controller will not work if there's an obstacle between it and the AV receiver's remote control sensor.

About the Remote Controller Modes

As well as the AV receiver, you can also use the remote controller to control your other AV components. The remote controller has a specific operating mode for use with each type of component. Modes are selected by using the REMOTE MODE buttons.

RECEIVER/TAPE Mode

In RECEIVER/TAPE mode, you can control the AV receiver and an Onkyo cassette recorder connected via **RI**.

DVD Mode

By default, you can control an Onkyo DVD player in this mode. By entering the appropriate remote control code, you can control components made by other manufacturers (see page 137).

CD/CDR/MD Mode

By default, you can control an Onkyo CD player in this mode. By entering the appropriate remote control code, you can control a CD player, MD recorder, or CD recorder made by another manufacturer (see page 137).

DOCK Mode

This mode is for controlling an Apple iPod in an Onkyo RI Dock. You must enter the appropriate remote control code first (see page 137).

NET/USB Mode (TX-NR906 only)

This mode is for playing music files on a networked computer, media server, or USB mass storage device, or for listening to Internet radio.

TV and VCR Modes

With these modes, you can control a TV and VCR. You must enter the appropriate remote control code first (see page 137).

CABLE/SAT Mode

In CABLE/SAT mode, you can control a cable or satellite TV receiver. You must enter the appropriate remote control code first (see page 137).

ZONE 2/ZONE 3 Modes

These modes are for controlling Zone 2 and Zone 3 (see page 133).

1	Use the REMOTE MODE buttons to select a mode.
2	Use the buttons supported by that mode to control the component.
	RECEIVER/TAPE mode: see right column
	DVD mode: see page 18
	CD/MD/CDR mode: see page 19
	DOCK mode: see page 20
	NET/USB mode (TX-NR906 only): see page 21
	TV, VCR, CABLE/SAT modes: see page 139

RECEIVER/TAPE Mode

RECEIVER/TAPE mode is used to control the AV receiver. It can also be used to control an Onkyo cassette recorder connected via **RI**.

To set the remote controller to RECEIVER/TAPE mode, press the [RECEIVER] REMOTE MODE button.

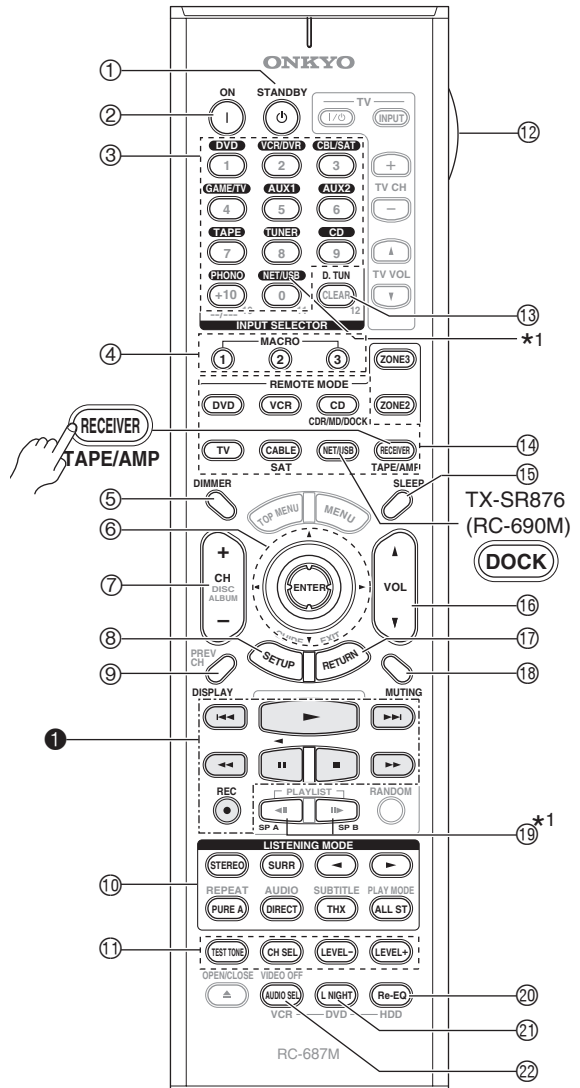

*1 TX-NR906 only (RC-687M)

Note:

Some of the remote controller functions described in this manual may not work as expected with other components.

Remote Controller—Continued

For detailed information, see the pages in parentheses.

- ① **STANDBY button (51)**
Sets the AV receiver to Standby.
- ② **ON button (51)**
Turns on the AV receiver.
- ③ **INPUT SELECTOR buttons (70)**
Used to select the input source.
- ④ **MACRO buttons (141)**
Used with the Macro function.
- ⑤ **DIMMER button (71)**
Adjusts the display brightness.
- ⑥ **Arrow [▲]/[▼]/[◀]/[▶] and ENTER buttons**
Used to select and adjust settings.
- ⑦ **CH +/- button (75)**
Selects radio presets.
- ⑧ **SETUP button**
Used to change settings.
- ⑨ **DISPLAY button (72)**
Displays information about the current input source.
- ⑩ **LISTENING MODE buttons (81)**
Used to select the listening modes. The [STEREO], [SURR], and LISTENING MODE [◀]/[▶] buttons can be used at any time, regardless of the currently selected remote controller mode.
- ⑪ **TEST TONE, CH SEL, LEVEL-, and LEVEL+ buttons (71, 100)**
Used to adjust the level of each speaker.
- ⑫ **LIGHT button**
Turns the remote controller's illuminated buttons on or off.
- ⑬ **D.TUN button (74)**
Selects the Direct tuning mode for radio.
- ⑭ **REMOTE MODE buttons (16)**
Used to select the remote controller modes. When you press a button, the REMOTE MODE button for the currently selected mode lights up.
- ⑮ **SLEEP button (72)**
Used with the Sleep function.
- ⑯ **VOL [▲]/[▼] button (70)**
Adjusts the volume of the AV receiver regardless of the currently selected remote controller mode.
- ⑰ **RETURN button**
Returns to the previous display when changing settings.
- ⑱ **MUTING button (71)**
Mutes or unmutes the AV receiver.
- ⑲ **SP A and SP B buttons (TX-NR906 only) (8, 23)**
Used to select Speakers A or Speakers B.

- ⑳ **Re-EQ button (108)**
Turns the Re-EQ function on or off.
- ㉑ **L NIGHT button (109)**
Turns the Late Night function on or off.
- ㉒ **AUDIO SEL button (120)**
Selects the audio input: analog, digital, HDMI, or multichannel.

■ TAPE mode

On twin cassette decks, only Deck B can be controlled.

① Previous and Next [◀◀]/[▶▶] buttons

The Previous [◀◀] button selects the previous track. During playback it selects the beginning of the current track. The Next [▶▶] button selects the next track.

Depending on how they were recorded, the Previous and Next [◀◀]/[▶▶] buttons may not work properly with some cassette tapes.

Play [▶] button

Starts playback.

Rewind and Fast Forward [◀◀]/[▶▶] buttons

The Rewind [◀◀] button starts rewind. The Fast Forward [▶▶] button starts fast forward.

Reverse Play [◀] button

Starts reverse playback.

Stop [■] button

Stops playback.

REC [●] button

Starts recording.

DVD Mode

To set the remote controller to DVD mode, press the [DVD] REMOTE MODE button.

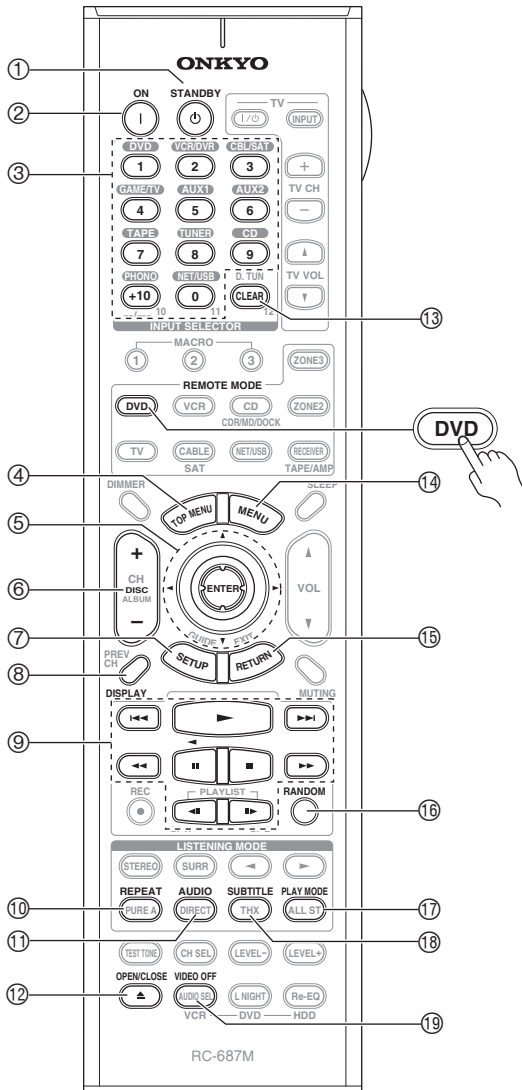

- ① **STANDBY button**
Sets the DVD player to Standby.
- ② **ON button**
Turns on the DVD player.
- ③ **Number buttons**
Used to enter title, chapter, and track numbers, and to enter times for locating specific points.
- ④ **TOP MENU button**
Selects a DVD's top menu.
- ⑤ **Arrow [▲]/[▼]/[◀]/[▶] and ENTER buttons**
Used to navigate menus and select items.
- ⑥ **DISC +/- button**
Selects discs on a DVD changer.
- ⑦ **SETUP button**
Used to access the DVD player's settings.
- ⑧ **DISPLAY button**
Displays information about the current disc, title, chapter, or track, including elapsed time, remaining time, total time, and so on.
- ⑨ **Playback buttons**
From left to right: Previous, Play, Next, Fast Reverse, Pause, Stop, Fast Forward, Slow Reverse, and Slow Forward.
- ⑩ **REPEAT button**
Used with the repeat playback function.
- ⑪ **AUDIO button**
Selects foreign language soundtracks and audio formats (e.g., Dolby Digital or DTS).
- ⑫ **OPEN/CLOSE [▲] button**
Opens and closes the disc tray.
- ⑬ **CLEAR button**
Cancels functions and clears entered numbers.
- ⑭ **MENU button**
Displays a DVD's menu.
- ⑮ **RETURN button**
Exits the DVD player's onscreen setup menu.
- ⑯ **RANDOM button**
Used with the random playback function.
- ⑰ **PLAY MODE button**
Selects play modes on components with selectable play modes.
- ⑱ **SUBTITLE button**
Selects subtitles.
- ⑲ **VIDEO OFF button**
Turns off the internal video circuitry, eliminating any possibility of interference.

CD/MD/CDR Modes

To control an Onkyo CD player, MD recorder, or CD recorder, or a CD or MD player/recorder made by another manufacturer, press the [CD] REMOTE MODE button to select the CD/MD/CDR remote controller mode.

In order to control an Onkyo MD recorder or CD recorder, or a component made by another manufacturer, you must first enter the appropriate remote control code (see page 137).

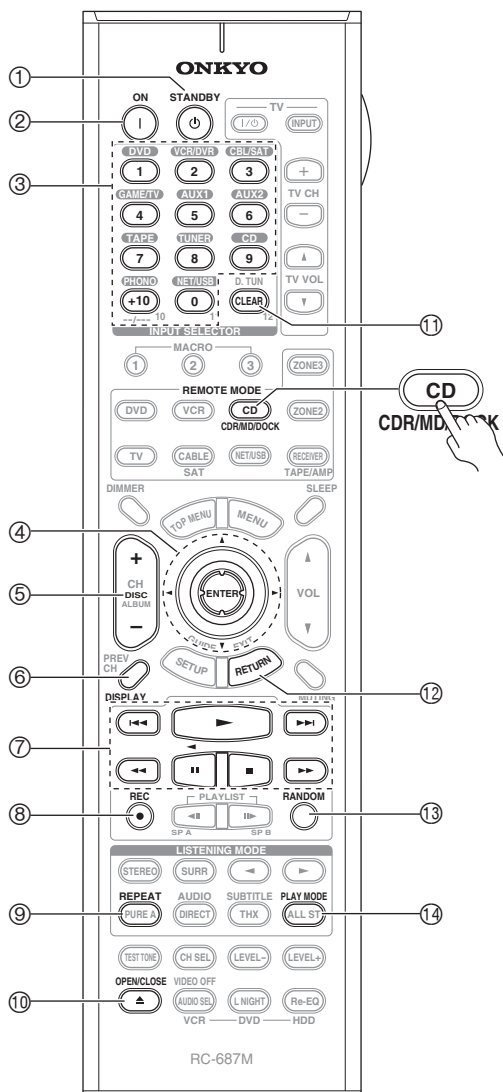

- ① **STANDBY button**
Sets the component to Standby.
- ② **ON button**
Set the component to On or Standby.
- ③ **Number buttons**
Used to enter track numbers and times for locating specific points.
- ④ **Arrow [▲]/[▼]/[◀]/[▶] and ENTER buttons**
Used with some components.
- ⑤ **DISC +/- button**
Selects discs on a CD changer.
- ⑥ **DISPLAY button**
Displays information about the current disc or track, including elapsed time, remaining time, total time, and so on.
- ⑦ **Playback buttons**
From left to right: Previous, Play, Next, Fast Reverse, Pause, Stop, and Fast Forward.
- ⑧ **REC [●] button**
Starts recording.
- ⑨ **REPEAT button**
Used with the repeat playback function.
- ⑩ **OPEN/CLOSE [▲] button**
Opens or closes the disc tray or ejects the MiniDisc.
- ⑪ **CLEAR button**
Cancels functions and clears entered numbers.
- ⑫ **RETURN button**
Used with some components.
- ⑬ **RANDOM button**
Used with the random playback function.
- ⑭ **PLAY MODE button**
Selects play modes on components with selectable play modes.

DOCK Mode

Dock mode is for controlling an Apple iPod in an Onkyo RI Dock.

To control an RI Dock, press the [CD] (TX-NR906) or [DOCK] (TX-SR876) REMOTE MODE button to select the DOCK remote controller mode.

In order to control an RI Dock, you must first enter the appropriate remote control code (see page 137).

When Using an RI Dock:

- Connect the RI Dock to the TAPE IN or AUX 1 IN L/R jacks.
- Set the RI Dock's RI MODE switch to HDD or HDD/DOCK.
- Set the AV receiver's Input Display to "DOCK" (see page 63).
- See to the RI Dock's instruction manual for more information.

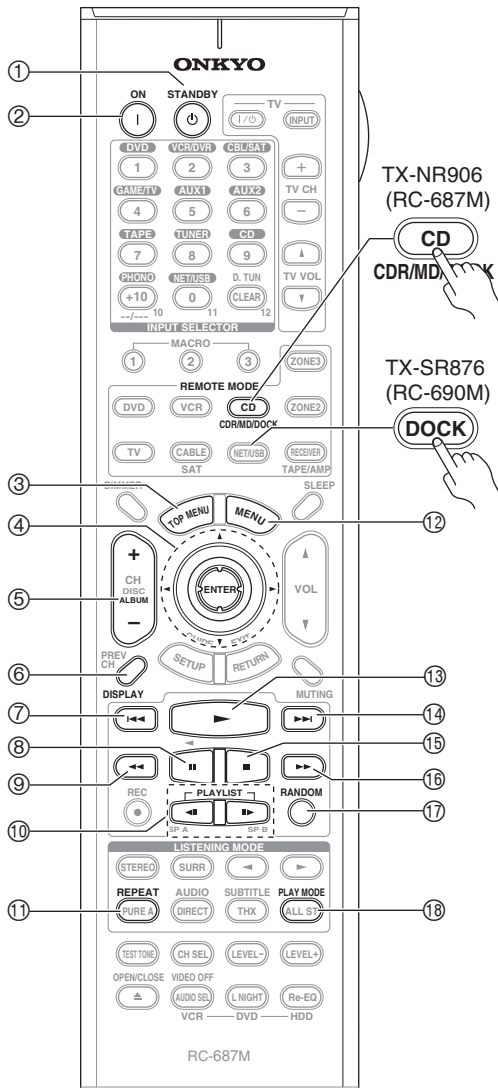

- STANDBY button**
Turns off the iPod.
- ON button***
Turns on the iPod.
- TOP MENU button**
Works as a Mode button when used with a DS-A2 RI Dock.
- Arrow [▲]/[▼] and ENTER buttons***
Used to navigate menus and select items.
- ALBUM +/- button***
Selects the next or previous album.
- DISPLAY button***
Turns on the backlight for 30 seconds.
- Previous [◀◀] button**
Restarts the current song. Press it twice to select the previous song.
- Pause [||] button**
Pauses playback. (With 3rd generation iPods, it works as a Play/Pause button.)
- Fast Reverse [◀◀] button**
Press and hold to fast reverse.
- PLAYLIST Up/Down [◀||]/[||▶] buttons***
Used to select the previous or next playlist on the iPod.
- REPEAT button***
Used with the repeat function.
- MENU button***
Used to access menus.
- Play [▶▶] button**
Starts playback. If the component is off, it will turn on automatically. (With 3rd generation iPods, this button works as a Play/Pause button.)
- Next [▶▶] button**
Selects the next song.
- Stop [■] button**
Stops playback and displays a menu.
- Fast Forward [▶▶▶] button**
Press and hold to fast forward.
- RANDOM button***
Used with the shuffle function.
- PLAY MODE button**
Used to select play modes on components with selectable play modes.
Works as a Resume button when used with a DS-A2 RI Dock.

* Buttons marked with an asterisk (*) are not supported by 3rd generation iPods.

NET/USB Mode (TX-NR906 only)

NET/USB mode is for playing music files on a networked computer, media server, or USB mass storage device, or for listening to Internet radio.

To set the remote controller to NET/USB mode, press the [NET/USB] REMOTE MODE button.

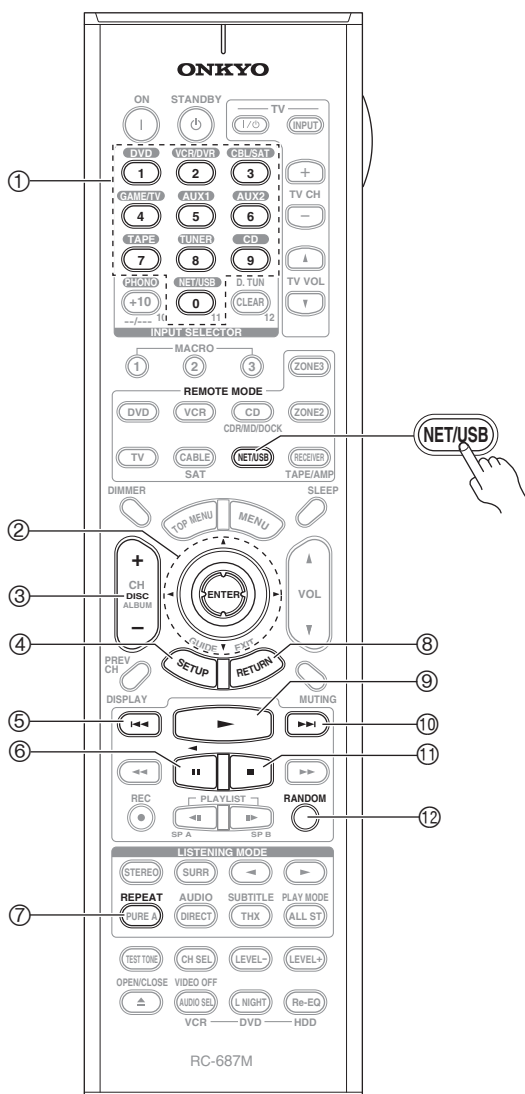

- ① **Number buttons**
Used to enter track numbers.
- ② **Arrow [▲]/[▼]/[◀]/[▶] and ENTER buttons**
Used to navigate menus and select items.
- ③ **CH +/- button**
Used to select Internet radio stations.
- ④ **SETUP button**
Displays the URL input screen for Internet radio.
- ⑤ **Previous [◀◀] button**
Restarts the current song. Press it twice to select the previous song.
- ⑥ **Pause [||] button**
Pauses playback of music stored on a USB mass storage device.
- ⑦ **REPEAT button**
Used with the repeat playback function, which can be used with music files on a networked computer, media server, or USB mass storage device.
- ⑧ **RETURN button**
Returns to the previous display.
- ⑨ **Play [▶] button**
Starts playback.
- ⑩ **Next [▶▶] button**
Selects the next song.
- ⑪ **Stop [■] button**
Stops playback.
- ⑫ **RANDOM button**
Used with the random playback function, which can be used with music files on a networked computer, media server, or USB mass storage device.

About Home Theater

Enjoying Home Theater

Thanks to the AV receiver's superb capabilities, you can enjoy surround sound with a real sense of movement in your own home—just like being in a movie theater or concert hall. With DVDs you can enjoy DTS and Dolby Digital. With analog or digital TV, you can enjoy Dolby Pro Logic Ix, DTS Neo:6, or Onkyo's original DSP listening modes. You can also enjoy THX Surround EX (THX-certified THX speaker system recommended).

Front left and right speakers

These output the main sound. Their role in a home theater is to provide a solid anchor for the sound image. They should be positioned facing the listener at about ear level, and equally spaced from the TV. Angle them inward slightly so as to create a triangle, with the listener at the apex.

Surround left and right speakers

These speakers are used for precise sound positioning and to add realistic ambience.

Position them at the sides of the listener, or slightly behind, about 2–3 feet (60–100 cm) above ear level. Ideally they should be equally spaced from the listener.

Center speaker

This speaker enhances the front left and right speakers, making sound movements distinct and providing a full sound image. For movies it's used mainly for dialog.

Position it close to your TV (preferably on top) facing forward at about ear level, or at the same height as the front left and right speakers.

Subwoofer

The subwoofer handles the bass sounds of the LFE (Low-Frequency Effects) channel. The volume and quality of the bass output from your subwoofer will depend on its position, the shape of your listening room, and your listening position. In general, a good bass sound can be obtained by installing the subwoofer in a front corner, or at one-third the way along the front wall, as shown.

Tip: To find the best position for your subwoofer, while playing a movie or some music with good bass, experiment by placing your subwoofer at various positions within the room and choose the one that provides the most satisfying results.

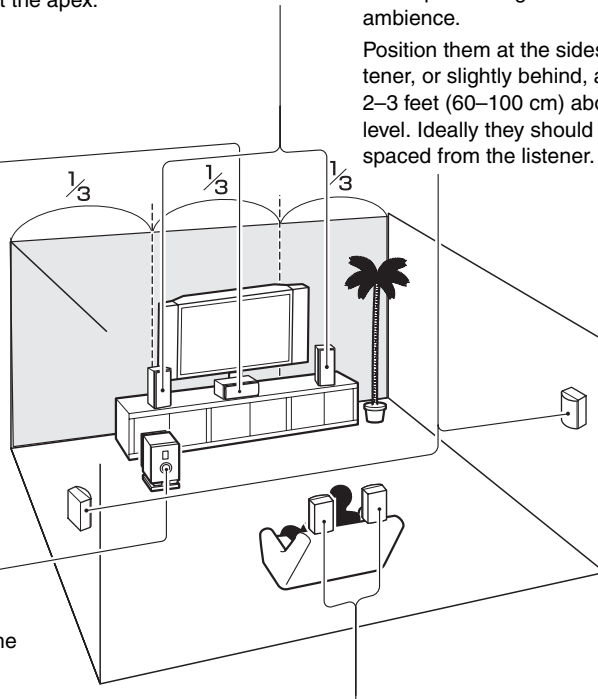

Surround back left and right speakers

These speakers are necessary to enjoy Dolby Digital EX, DTS-ES Matrix, DTS-ES Discrete, THX Surround EX, etc. They enhance the realism of surround sound and improve sound localization behind the listener. Position them behind the listener about 2–3 feet (60–100 cm) above ear level.

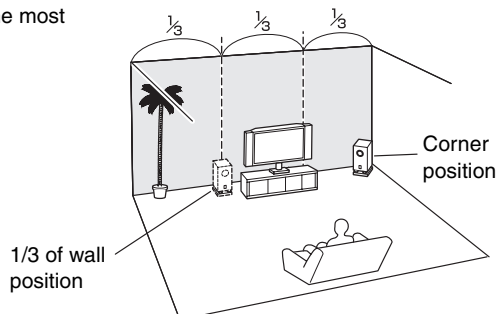

Connecting the AV Receiver

Connecting Your Speakers

About Speakers A and Speakers B (TX-NR906 only)

Speakers A and Speakers B allows you to have two speaker configurations of up to 7.1 speakers. Each configuration has its own pair of stereo front speakers and can use the same subwoofer, center, surround, and surround back speakers, as required. You could, for example, use Speakers A when watching a DVD movie with 7.1-channels surround sound and use Speakers B for serious music listening with a pair of stereo speakers and the subwoofer (2.1-channels).

The speakers are configured by using the “Speaker Settings” on page 61 and “Speaker Setup” on page 95.

Front Speakers A and front Speakers B can be wired normally, bi-amped, or bridged, but A and B cannot be bi-amped or bridged at the same time. For example, if front Speakers A are bridged, front Speakers B can only be wired normally. Similarly, if front Speakers B are bi-amped, Speakers A can only be wired normally. When bridging is used, the AV receiver can drive 2 speakers in the main room (2.1 speakers if you’re using a powered subwoofer). When bi-amping is used, the AV receiver can drive up to 5.1 speakers in the main room. See pages 27–30 for more information.

The Speakers A and Speakers B configurations are selected by using the [SPA] and [SPB] buttons on the remote controller. Only one configuration can be selected at a time.

The versatility offered by the Speakers A and Speakers B configurations means you can configure the AV receiver to suit your exact requirements and application. Two typical applications are shown below.

■ 7.1-channel Playback with Speakers A and Stereo Playback with Speakers B

In this example, Speakers A provides 7.1-channel surround sound for enjoying DVD movies, while Speakers B is used for serious music listening with a pair of top-quality stereo speakers.

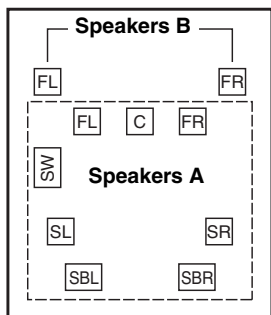

2-1. Speaker Settings		ONKYO
Speaker Impedance		6ohms
Speaker Type		Normal
Front(Speaker A)		Normal
Front(Speaker B)		Normal

2-2. Speaker Config		ONKYO
Subwoofer	Use	
Front	Use	
Center	Use	
Surround	Use	
Surround	Use	
SurrBack	Use	

2-2. Speaker Config		ONKYO
Subwoofer	Not Use	
Front	Use	
Center	Not Use	
Surround	Not Use	
Surround	Not Use	
SurrBack	Not Use	

■ 7.1-channel Playback with Bridged Front Speakers

In this example, Speakers A provides 7.1-channel surround sound for enjoying DVD movies, while Speakers B is bridged for use with a pair of high-power stereo speakers, the subwoofer is used with Speakers A and Speakers B.

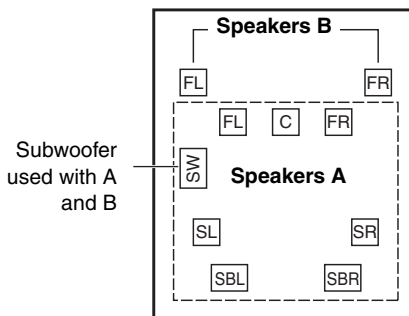

2-1. Speaker Settings		ONKYO
Speaker Impedance		8ohms
Speaker Type		Normal
Front(Speaker A)		Normal
Front(Speaker B)		BTL

2-2. Speaker Config		ONKYO
Subwoofer	Use	
Front	Use	
Center	Use	
Surround	Use	
Surround	Use	
SurrBack	Use	

2-2. Speaker Config		ONKYO
Subwoofer	Use	
Front	Use	
Center	Not Use	
Surround	Not Use	
Surround	Not Use	
SurrBack	Not Use	

Connecting the AV Receiver—Continued

Speaker Configuration

For 7.1-channel surround-sound playback, you need seven speakers and a powered subwoofer.

The following table shows which channels you should use based on the number of speakers you have.

Number of speakers:	2	3	4	5	6	7
Front left	✓	✓	✓	✓	✓	✓
Front right	✓	✓	✓	✓	✓	✓
Center		✓		✓	✓	✓
Surround left			✓	✓	✓	✓
Surround right			✓	✓	✓	✓
Surround back*					✓	
Surround back left						✓
Surround back right						✓

* If you're using only one surround back speaker, connect it to the SURR BACK L terminals.

No matter how many speakers you use, a powered subwoofer is recommended for a powerful and solid bass.

To get the best from your surround-sound system, you must set the speaker settings. You can do this automatically (see page 64) or manually (see page 95).

Using Dipole Speakers

You can use dipole speakers for the surround left and right and surround back left and right speakers. Dipole speakers output the same sound in two directions.

Dipole speakers typically have an arrow printed on them to indicate how they should be positioned. The surround left and right dipole speakers should be positioned so that their arrows point toward your TV or screen, while the surround back left and right dipolar speakers should be positioned so that their arrows point toward each other, as shown.

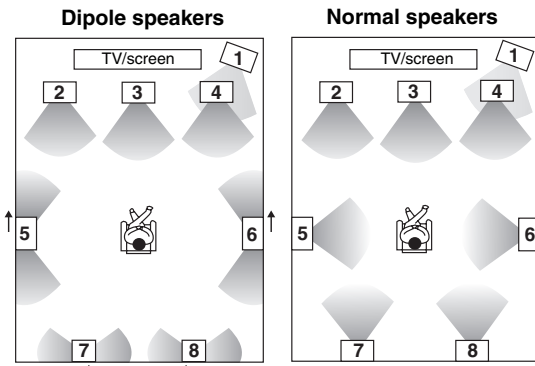

1. Subwoofer
2. Front left speaker
3. Center speaker
4. Front right speaker
5. Surround left speaker

6. Surround right speaker
7. Surround back left speaker
8. Surround back right speaker

Connecting a Powered Subwoofer

Using a suitable cable, connect the AV receiver's PRE OUT: SUBWOOFER to the input on your powered subwoofer. If your subwoofer is unpowered and you're using an external amplifier, connect the PRE OUT: SUBWOOFER to the amp's input.

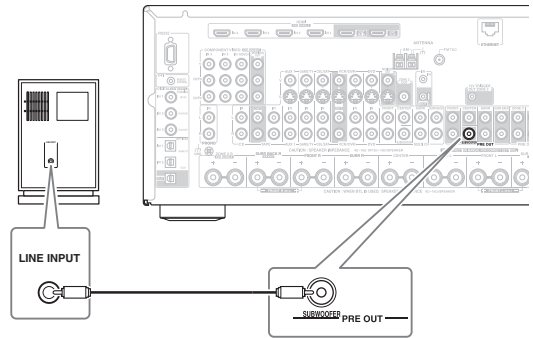

Attaching the Speaker Labels

The AV receiver's positive (+) speaker terminals are color-coded for ease of identification. (The negative (-) speaker terminals are all black.)

Speaker terminal	Color
Front left, Zone 2 left	White
Front right, Zone 2 right	Red
Center	Green
Surround left	Blue
Surround right	Gray
Surround back left	Brown
Surround back right	Tan

The supplied speaker labels are also color-coded and you should attach them to the positive (+) side of each speaker cable in accordance with the above table. All you need to do then is to match the color of each label to the corresponding speaker terminal.



For North American model

- If you are using banana plugs, tighten the speaker terminal before inserting the banana plug.
- Do not insert the speaker code directly into the center hole of the speaker terminal.

Connecting the AV Receiver—Continued

Speaker Connection Precautions

Read the following before connecting your speakers:

- You can connect speakers with an impedance of between 4 and 16 ohms. If the impedance of any of the connected speakers is 4 ohms or more but less than 6, be sure to set the speaker impedance to 4 ohms (see page 61). If you use speakers with a lower impedance, and use the amplifier at high volume levels for a long period of time, the built-in amp protection circuit may be activated.
- Disconnect the power cord from the wall outlet before making any connections.
- Read the instructions supplied with your speakers.
- Pay close attention to speaker wiring polarity. Connect positive (+) terminals to only positive (+) terminals, and negative (–) terminals to only negative (–) terminals. If you get them the wrong way around, the sound will be out of phase and will sound unnatural.
- Unnecessarily long or very thin speaker cables may affect the sound quality and should be avoided.
- Be careful not to short the positive and negative wires. Doing so may damage the AV receiver.
- Don't connect more than one cable to each speaker terminal. Doing so may damage the AV receiver.
- Don't connect a speaker to several terminals.

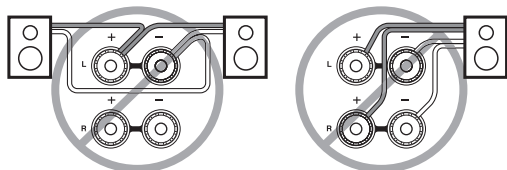
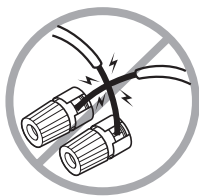

Connecting the Speaker Cables

- 1 Strip about 5/8" (15 mm) of insulation from the ends of the speaker cables, and twist the bare wires tightly, as shown.**

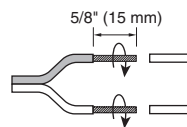

- 2 Unscrew the terminal.**



- 3 Fully insert the bare wire.**



- 4 Screw the terminal tight.**



Connecting the AV Receiver—Continued

■ 7.1-channel Playback with Speakers A

The following illustration shows which speaker should be connected to each pair of terminals for 7.1-channel playback with Speakers A.

If you're using only one surround back speaker, connect it to the SURR BACK L terminals.

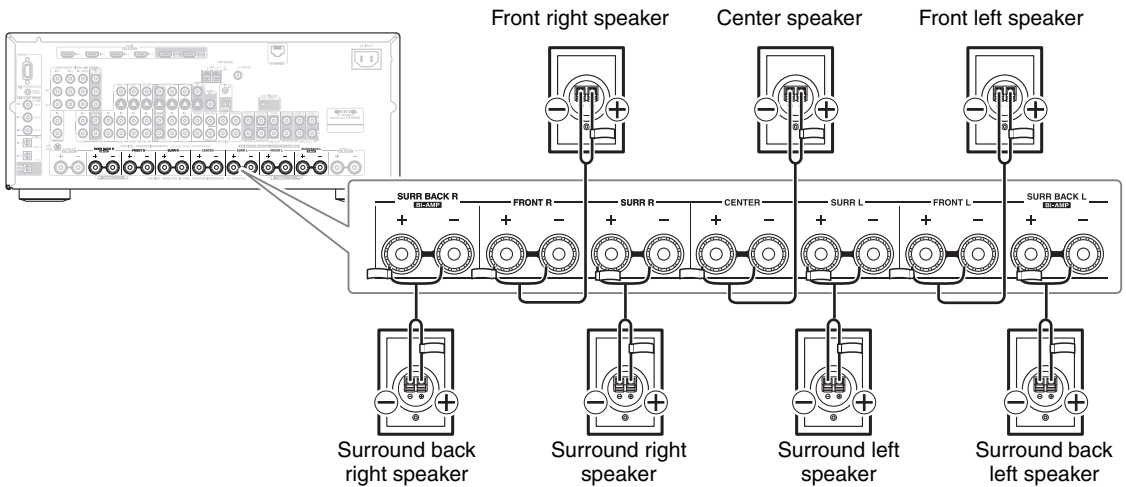

■ 7.1-channel Playback with Speakers A or Speakers B

The following illustration shows which speaker should be connected to each pair of terminals for up to 7.1-channel playback with Speakers A or Speakers B.

If you're using only one surround back speaker, connect it to the SURR BACK L terminals.

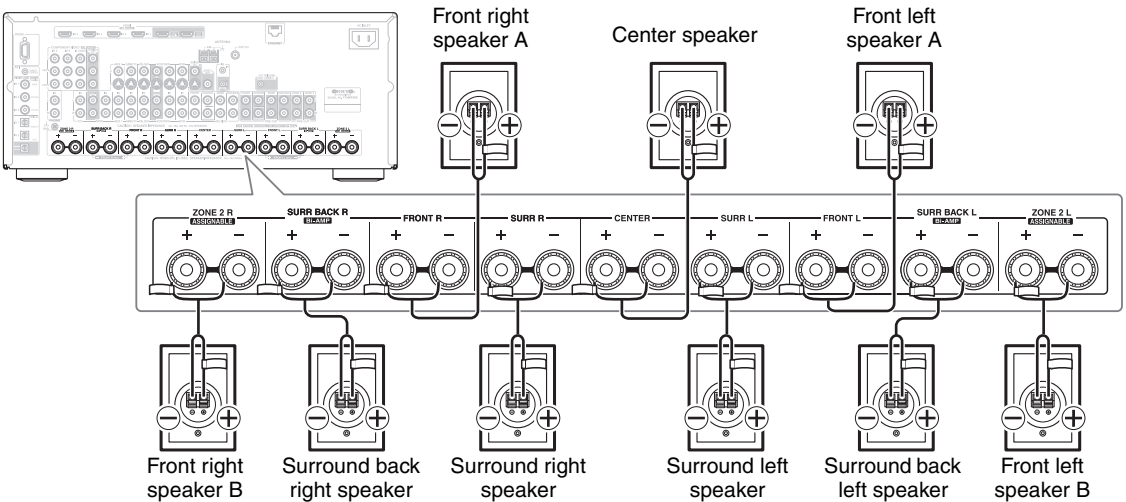

Notes:

- When Speakers A is selected, the front left speaker A and front right speaker A become the main front speakers. When Speakers B is selected, the front left speaker B and front right speaker B become the main front speakers.
- The speakers are configured by using the “Speaker Settings” on page 61 and “Speaker Setup” on page 95.
- You can choose which of the speakers you want to use with the Speakers A and Speakers B configurations (see page 98).

Bi-amping Front Speakers A

The FRONT L/R and SURR BACK L/R terminal posts can be used with front Speakers A and surround back speakers respectively, or bi-amped to provide separate tweeter and woofer feeds for front Speakers A, providing improved bass and treble performance.

- When bi-amping is used, the AV receiver is able to drive up to 5.1 speakers in the main room.
- For bi-amping, the FRONT L/R terminal posts connect to the front speakers' tweeter terminals. And the SURR BACK L/R terminal posts connect to the front speakers' woofer terminals.
- Once you've completed the bi-amping connections shown below and turned on the AV receiver, you must set the "Speaker Type: Front(Speaker A)" setting to "Bi-Amp" to enable bi-amping (see page 61).
- When front Speakers A are biamped, front Speakers B must be wired normally or not used.

Important:

- **When making the bi-amping connections, be sure to remove the jumper bars that link the speakers' tweeter (high) and woofer (low) terminals.**
- Bi-amping can only be used with speakers that support bi-amping. Refer to your speaker manual.

Bi-amping Speaker Hookup

- 1 Connect the AV receiver's FRONT R positive (+) terminal to the right speaker's positive (+) woofer (low) terminal. And connect the AV receiver's FRONT R negative (-) terminal to the right speaker's negative (-) woofer (low) terminal.
- 2 Connect the AV receiver's SURR BACK R positive (+) terminal to the right speaker's positive (+) tweeter (high) terminal. And connect the AV receiver's SURR BACK R negative (-) terminal to the right speaker's negative (-) tweeter (high) terminal.
- 3 Connect the AV receiver's FRONT L positive (+) terminal to the left speaker's positive (+) woofer (low) terminal. And connect the AV receiver's FRONT L negative (-) terminal to the left speaker's negative (-) woofer (low) terminal.
- 4 Connect the AV receiver's SURR BACK L positive (+) terminal to the left speaker's positive (+) tweeter (high) terminal. And connect the AV receiver's SURR BACK L negative (-) terminal to the left speaker's negative (-) tweeter (high) terminal.

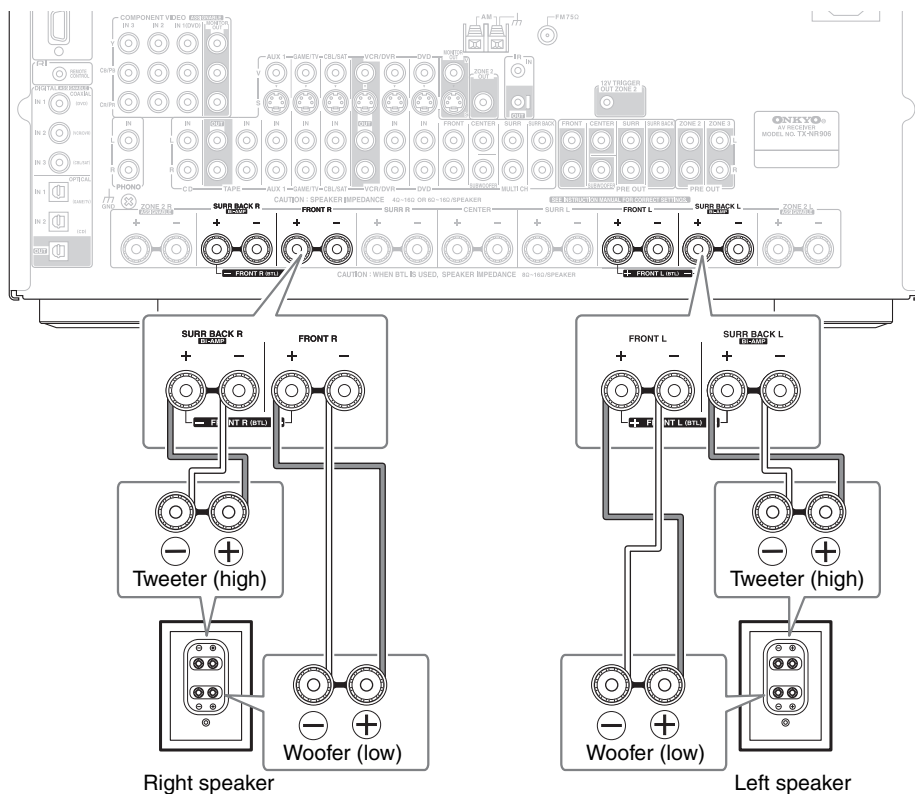

Bridging Front Speakers A

The FRONT L/R and SURR BACK L/R terminal posts can be used with front speakers and surround back speakers respectively, or bridged together to provide almost double the output power for the front speakers.

- When bridging is used, the AV receiver is able to drive 2 speakers in the main room (2.1 speakers if you're using a powered subwoofer).
- For bridging, the positive (+) FRONT L/R and SURR BACK L/R terminal posts are used, but the negative (–) FRONT L/R and SURR BACK L/R terminals are not.
- Once you've completed the bridging connections shown below and turned on the AV receiver, you must set the "Speaker Type: Front(Speaker A)" setting to "BTL" to enable bridging (see page 61).
- When front Speakers A are bridged, front Speakers B must be wired normally or not used.

Notes:

- Use only front speakers with an impedance of 8 ohms or higher for bridging. Failure to do so may seriously damage the AV receiver.
- When using bridging, make sure that your front speakers can handle the additional power.

Bridged Speaker Hookup

- 1 Connect the AV receiver's FRONT R positive (+) terminal to the right speaker's positive (+) terminal. And connect the AV receiver's SURR BACK R positive (+) terminal to the right speaker's negative terminal.
- 2 Connect the AV receiver's FRONT L positive (+) terminal to the left speaker's positive (+) terminal. And connect the AV receiver's SURR BACK L positive (+) terminal to the left speaker's negative terminal.

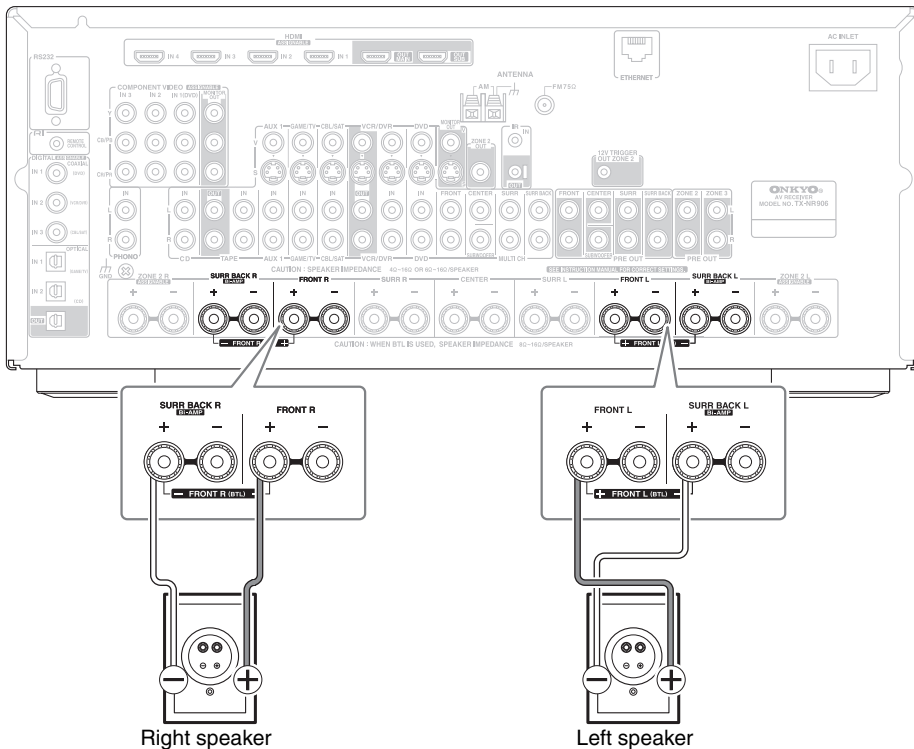

Bi-amping Front Speakers B

The ZONE 2 L/R and SURR BACK L/R terminal posts can be used with front Speakers B and surround back speakers respectively, or bi-amped to provide separate tweeter and woofer feeds for front Speakers B, providing improved bass and treble performance.

- When bi-amping is used, the AV receiver is able to drive up to 5.1 speakers in the main room.
- For bi-amping, the ZONE 2 L/R terminal posts connect to the front speakers' tweeter terminals. And the SURR BACK L/R terminal posts connect to the front speakers' woofer terminals.
- Once you've completed the bi-amping connections shown below and turned on the AV receiver, you must set the "Speaker Type: Front(Speaker B)" setting to "Bi-Amp" to enable bi-amping (see page 61).
- When front Speakers B are biamped, front Speakers A must be wired normally.

Important:

- **When making the bi-amping connections, be sure to remove the jumper bars that link the speakers' tweeter (high) and woofer (low) terminals.**
- Bi-amping can only be used with speakers that support bi-amping. Refer to your speaker manual.

Bi-amping Speaker Hookup

- 1 Connect the AV receiver's ZONE 2 R positive (+) terminal to the right speaker's positive (+) tweeter (high) terminal. And connect the AV receiver's ZONE 2 R negative (-) terminal to the right speaker's negative (-) tweeter (high) terminal.
- 2 Connect the AV receiver's SURR BACK R positive (+) terminal to the right speaker's positive (+) woofer (low) terminal. And connect the AV receiver's SURR BACK R negative (-) terminal to the right speaker's negative (-) woofer (low) terminal.
- 3 Connect the AV receiver's ZONE 2 L positive (+) terminal to the left speaker's positive (+) tweeter (high) terminal. And connect the AV receiver's ZONE 2 L negative (-) terminal to the left speaker's negative (-) tweeter (high) terminal.
- 4 Connect the AV receiver's SURR BACK L positive (+) terminal to the left speaker's positive (+) woofer (low) terminal. And connect the AV receiver's SURR BACK L negative (-) terminal to the left speaker's negative (-) woofer (low) terminal.

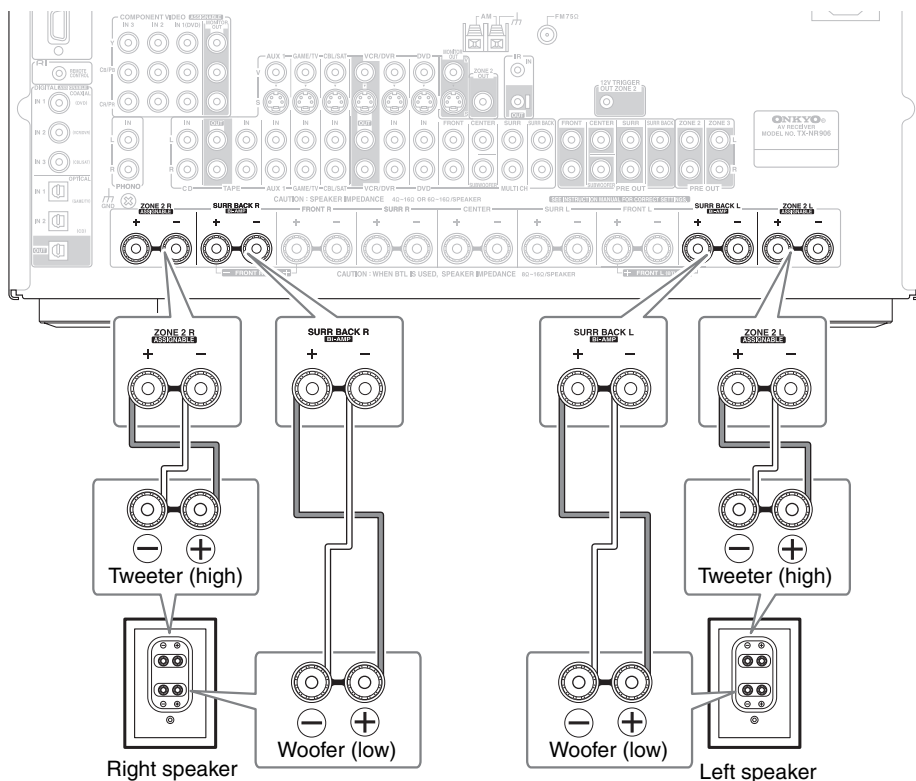

Bridging Front Speakers B

The ZONE 2 L/R and SURR BACK L/R terminal posts can be used with front speakers and surround back speakers respectively, or bridged together to provide almost double the output power for the front speakers.

- When bridging is used, the AV receiver is able to drive 2 speakers in the main room (2.1 speakers if you're using a powered subwoofer).
- For bridging, the positive (+) ZONE 2 L/R and SURR BACK L/R terminal posts are used, but the negative (–) ZONE 2 L/R and SURR BACK L/R terminals are not.
- Once you've completed the bridging connections shown below and turned on the AV receiver, you must set the "Speaker Type: Front(Speaker B)" setting to "BTL" to enable bridging (see page 61).
- When front Speakers B are bridged, front Speakers A must be wired normally.

Notes:

- Use only front speakers with an impedance of 8 ohms or higher for bridging. Failure to do so may seriously damage the AV receiver.
- When using bridging, make sure that your front speakers can handle the additional power.

Bridged Speaker Hookup

- 1 Connect the AV receiver's ZONE 2 R positive (+) terminal to the right speaker's positive (+) terminal. And connect the AV receiver's SURR BACK R positive (+) terminal to the right speaker's negative terminal.
- 2 Connect the AV receiver's ZONE 2 L positive (+) terminal to the left speaker's positive (+) terminal. And connect the AV receiver's SURR BACK L positive (+) terminal to the left speaker's negative terminal.

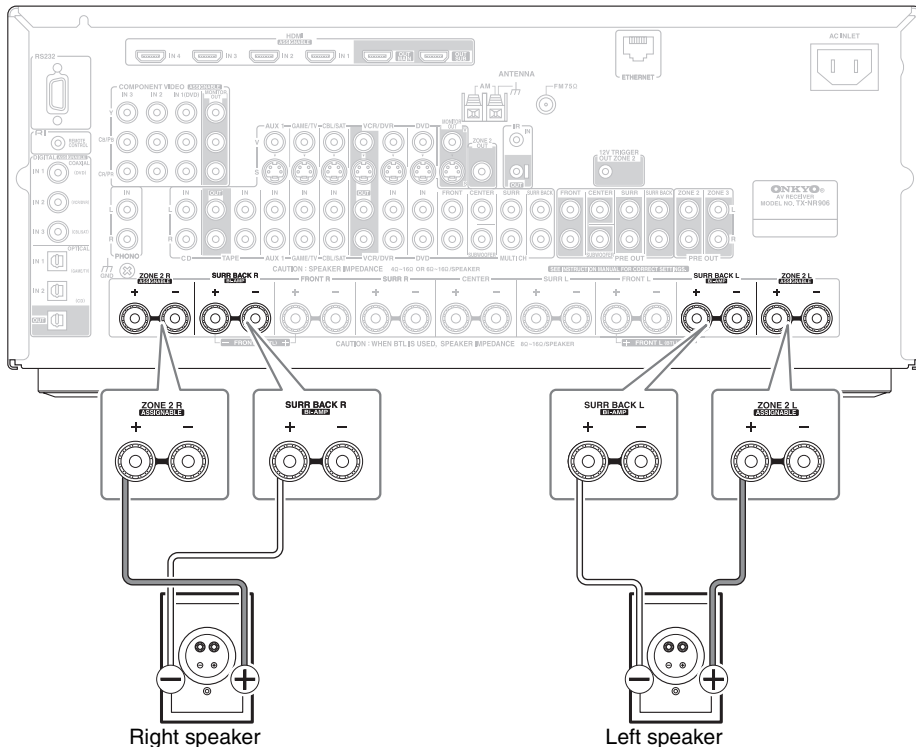

Connecting the AV Receiver—Continued

Connecting Antenna

This section explains how to connect the supplied indoor FM antenna and AM loop antenna, and how to connect commercially available outdoor FM and AM antennas.

The AV receiver won't pick up any radio signals without any antenna connected, so you must connect the antenna to use the tuner.

■ North American Model

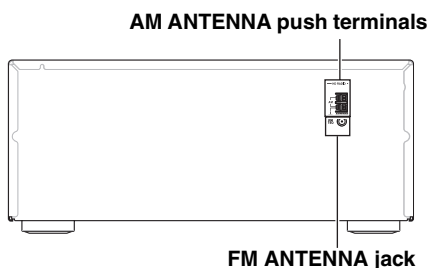

■ Other Models

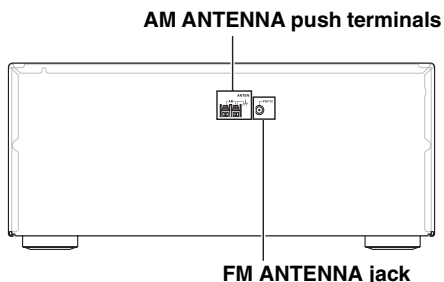

Connecting the Indoor FM Antenna

The supplied indoor FM antenna is for indoor use only.

1 Attach the FM antenna, as shown.

■ North American Model

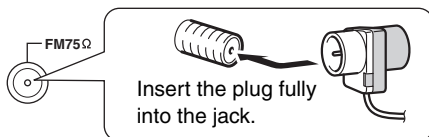

■ Other Models

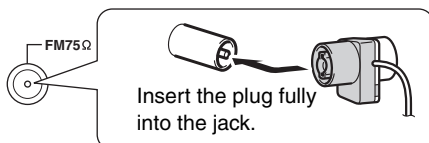

Once your AV receiver is ready for use, you'll need to tune into an FM radio station and adjust the position of the FM antenna to achieve the best possible reception.

2 Use thumbtacks or something similar to fix the FM antenna into position.

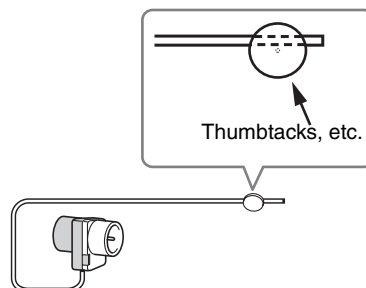

Caution: Be careful that you don't injure yourself when using thumbtacks.

If you cannot achieve good reception with the supplied indoor FM antenna, try a commercially available outdoor FM antenna instead (see page 32).

Connecting the AM Loop Antenna

The supplied indoor AM loop antenna is for indoor use only.

1 Assemble the AM loop antenna, inserting the tabs into the base, as shown.

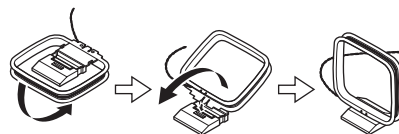

2 Connect both wires of the AM loop antenna to the AM push terminals, as shown.

(The antenna's wires are not polarity sensitive, so they can be connected either way around).

Make sure that the wires are attached securely and that the push terminals are gripping the bare wires, not the insulation.

■ North American Model

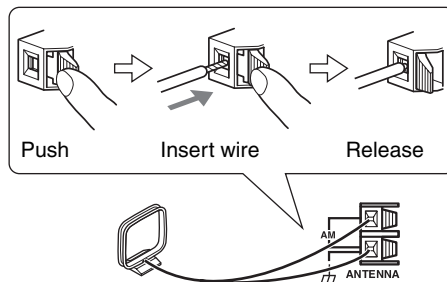

3 ■ Other Models

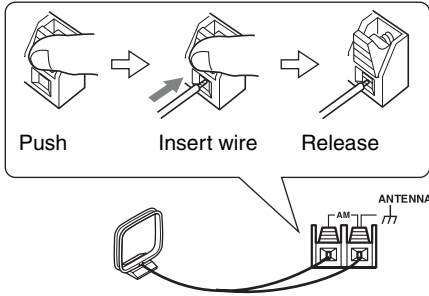

Once your AV receiver is ready for use, you'll need to tune into an AM radio station and adjust the position of the AM antenna to achieve the best possible reception.

Keep the antenna as far away as possible from your AV receiver, TV, speaker cables, and power cords.

If you cannot achieve good reception with the supplied indoor AM loop antenna, try using it with a commercially available outdoor AM antenna (see page 32).

Connecting an Outdoor FM Antenna

If you cannot achieve good reception with the supplied indoor FM antenna, try a commercially available outdoor FM antenna instead.

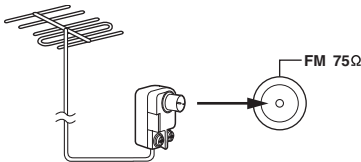

Notes:

- Outdoor FM antennas work best outside, but usable results can sometimes be obtained when installed in an attic or loft.
- For best results, install the outdoor FM antenna well away from tall buildings, preferably with a clear line of sight to your local FM transmitter.
- Outdoor antenna should be located away from possible noise sources, such as neon signs, busy roads, etc.
- For safety reasons, outdoor antenna should be situated well away from power lines and other high-voltage equipment.
- Outdoor antenna must be grounded in accordance with local regulations to prevent electrical shock hazards.

■ Using a TV/FM Antenna Splitter

It's best not to use the same antenna for both FM and TV reception, as this can cause interference problems. If cir-

cumstances demand it, use a TV/FM antenna splitter, as shown.

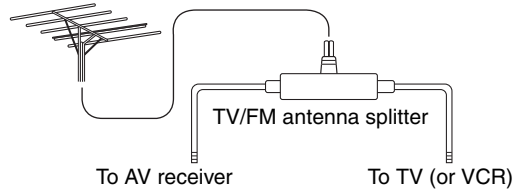

Connecting an Outdoor AM Antenna

If good reception cannot be achieved using the supplied AM loop antenna, an outdoor AM antenna can be used in addition to the loop antenna, as shown.

■ North American Model

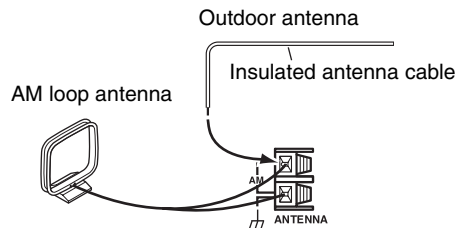

■ Other Models

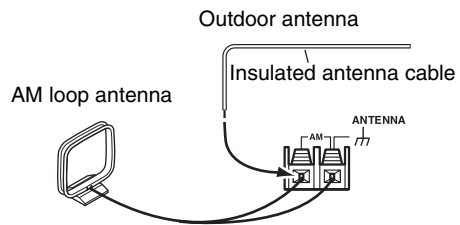

Outdoor AM antennas work best when installed horizontally outside, but good results can sometimes be obtained indoors by mounting horizontally above a window. Note that the AM loop antenna should be left connected.

Outdoor antenna must be grounded in accordance with local regulations to prevent electrical shock hazards.

Connecting the AV Receiver—Continued

About AV Connections

- Before making any AV connections, read the manuals supplied with your other AV components.
- Don't connect the power cord until you've completed and double-checked all AV connections.

Optical Digital Jacks

The AV receiver's optical digital jacks have shutter-type covers that open when an optical plug is inserted and close when it's removed. Push plugs in all the way.

Caution: To prevent shutter damage, hold the optical plug straight when inserting and removing.

AV Connection Color Coding

RCA-type AV connections are usually color coded: red, white, and yellow. Use red plugs to connect right-channel audio inputs and outputs (typically labeled "R"). Use white plugs to connect left-channel audio inputs and outputs (typically labeled "L"). And use yellow plugs to connect composite video inputs and outputs.



- Push plugs in all the way to make good connections (loose connections can cause noise or malfunctions).
- To prevent interference, keep audio and video cables away from power cords and speaker cables.

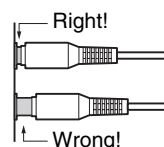

AV Cables and Jacks

Video		
Cable	Jack	Description
		HDMI connections can carry uncompressed standard- or high-definition digital video and audio and offer the best picture and sound quality.
		Component video separates the luminance (Y) and color difference signals (PR, PB), providing the best picture quality. (Some TV manufacturers label their component video jacks slightly differently.)
		S-Video separates the luminance and color signals and provides better picture quality than composite video.
		Composite video is commonly used on TVs, VCRs, and other video equipment.
Audio		
		This offers the best sound quality and allows you to enjoy Dolby Digital and DTS. The audio quality is the same as for coaxial.
		This offers the best sound quality and allows you to enjoy Dolby Digital and DTS. The audio quality is the same as for optical.
		This cable carries analog audio. It's the most common connection format for analog audio and can be found on virtually all AV components.
		This cable carries multichannel analog audio and is typically used to connect DVD players with a 7.1-channel analog audio output. Several standard analog audio cables can be used instead of a multichannel cable.

Note: The AV receiver does not support SCART connections.

Connecting Both Audio & Video

By connecting both the audio and video outputs of your DVD player and other AV components to the AV receiver, you can switch the audio and video signals simultaneously simply by changing the input source on the AV receiver.

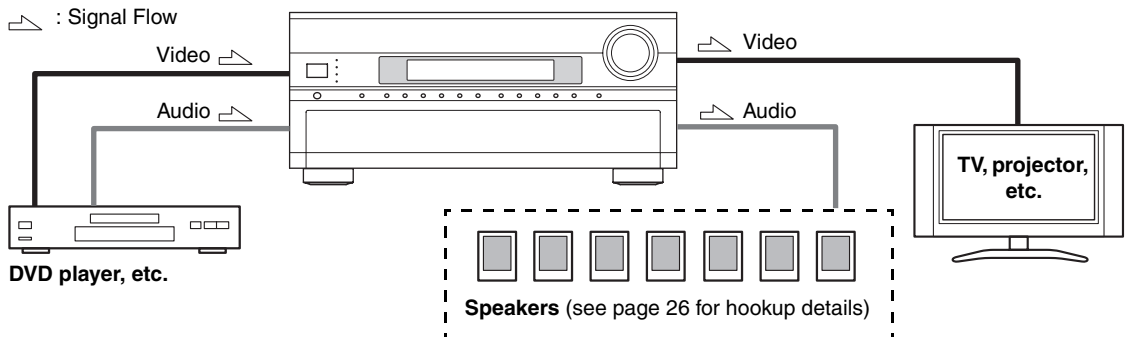

Which Connections Should I Use?

The AV receiver supports several connection formats for compatibility with a wide range of AV equipment. The format you choose will depend on the formats supported by your other components. Use the following sections as a guide.

For video components, you must make an audio connection and a video connection.

Video Connection Formats

Video equipment can be connected to the AV receiver by using any one of the following video connection formats: composite video, S-Video, component video, or HDMI, the latter offering the best picture quality.

The AV receiver can upconvert and downconvert between video formats, depending on the “Monitor Out” setting, which generally determines whether video signals are upconverted for the component video output or the HDMI outputs.

For optimal video performance, THX recommends that video signals pass through the system without upconversion (e.g., component video input through to component video output). It’s also recommended that you set the “Immediate Display” preference to “Off” (see page 116), the “Picture Adjust” setting to the default (see page 111), and the “Resolution” setting to “Through” (see page 55).

■ “Monitor Out” Setting Set to “HDMI Main” or “HDMI Sub”

With the “Monitor Out” setting set to “HDMI Main” or “HDMI Sub” (see page 52), video input signals flow through the AV receiver as shown, with composite video, S-Video, and component video sources all being upconverted for the respective HDMI output. **Use the “HDMI Main” or “HDMI Sub” setting if you connect the AV receiver’s HDMI OUT MAIN or HDMI OUT SUB, respectively, to your TV.**

The composite video, S-Video, and component video outputs pass through their respective input signals as they are.

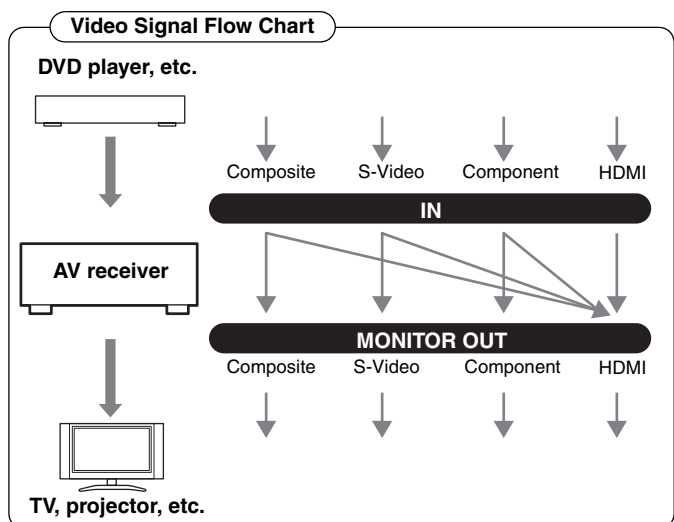

Connecting the AV Receiver—Continued

■ “Monitor Out” Setting Set to “Analog”

With the “Monitor Out” setting set to “Analog” (see page 52), video input signals flow through the AV receiver as shown, with composite video and S-Video sources being upconverted for the component video output. Use **this setting if you connect the AV receiver’s COMPONENT VIDEO MONITOR OUT to your TV.**

Composite video is upconverted to S-Video and S-Video is downconverted to composite video. Note that these conversions only apply to the MONITOR OUT V and S outputs, not the VCR/DVR OUT V and S outputs.

The composite video, S-Video, and component video outputs pass through their respective input signals as they are.

This signal flow also applies when the Monitor Out “Resolution” setting is set to “Through” (see page 55).

Video Signal Flow and the Resolution Setting

When the “Monitor Out” setting is set to “Analog” (see page 52), if the Monitor Out “Resolution” setting is set to anything other than “Through” (see page 55), the video signal flow will be as shown here, with composite video and S-Video sources being upconverted for the component video output.

The composite video, S-Video, and component video outputs pass through their respective analog input signals as they are. HDMI input signals are not output.

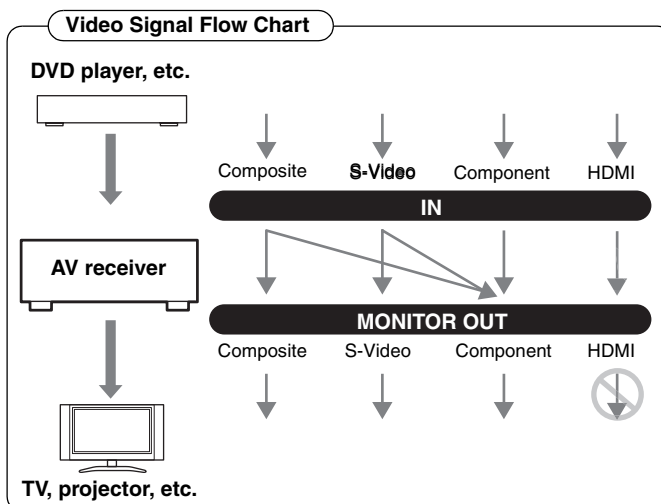
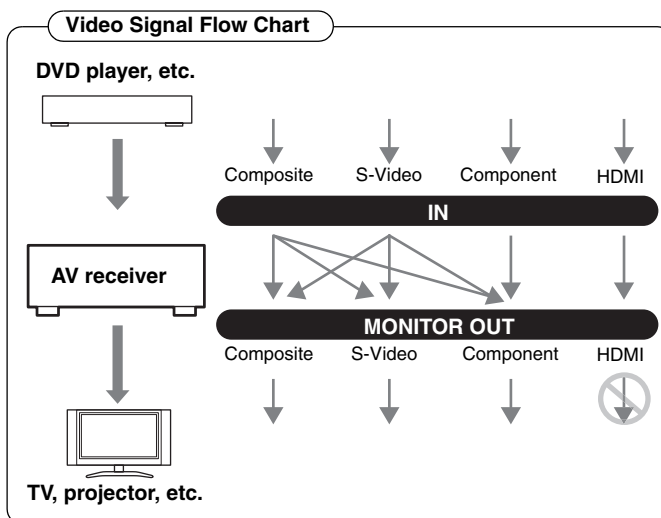

Audio Connection Formats

Audio equipment can be connected to the AV receiver by using any of the following audio connection formats: analog, optical, coaxial, analog multichannel, or HDMI.

When choosing a connection format, bear in mind that the AV receiver does not convert digital input signals for analog line outputs and vice versa. For example, audio signals connected to an optical or coaxial digital input are not output by the analog TAPE OUT.

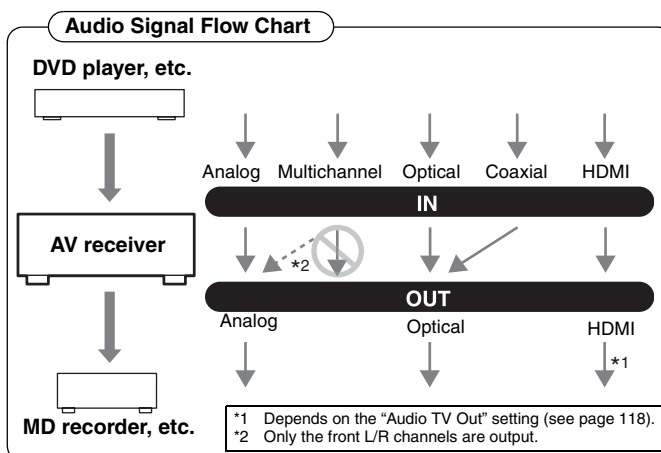

Connecting the AV Receiver—Continued

Connecting a TV or Projector

See “Connecting Components with HDMI” on page 42 for HDMI connection information.

Step 1: Video Connection

Choose a video connection that matches your TV (**A**, **B**, or **C**), and then make the connection.

Step 2: Audio Connection

Choose an audio connection that matches your TV (**a**, **b**, or **c**), and then make the connection.

- With connection **a**, you can listen to and record audio from your TV or listen in Zone 2 or Zone 3.
- To enjoy Dolby Digital and DTS, use connection **b** or **c**. (To record or listen in Zone 2 or Zone 3 as well, use **a** and **b**, or **a** and **c**.)

Connection	AV receiver	Signal flow	TV
A	COMPONENT VIDEO MONITOR OUT	⇒	Component video input
B	MONITOR OUT S	⇒	S-Video input
C	MONITOR OUT V	⇒	Composite video input
a	GAME/TV IN L/R	⇐	Analog audio L/R output
b	DIGITAL COAXIAL IN 2 (VCR/DVR)	⇐	Digital coaxial output
c	DIGITAL OPTICAL IN 1 (GAME/TV)	⇐	Digital optical output

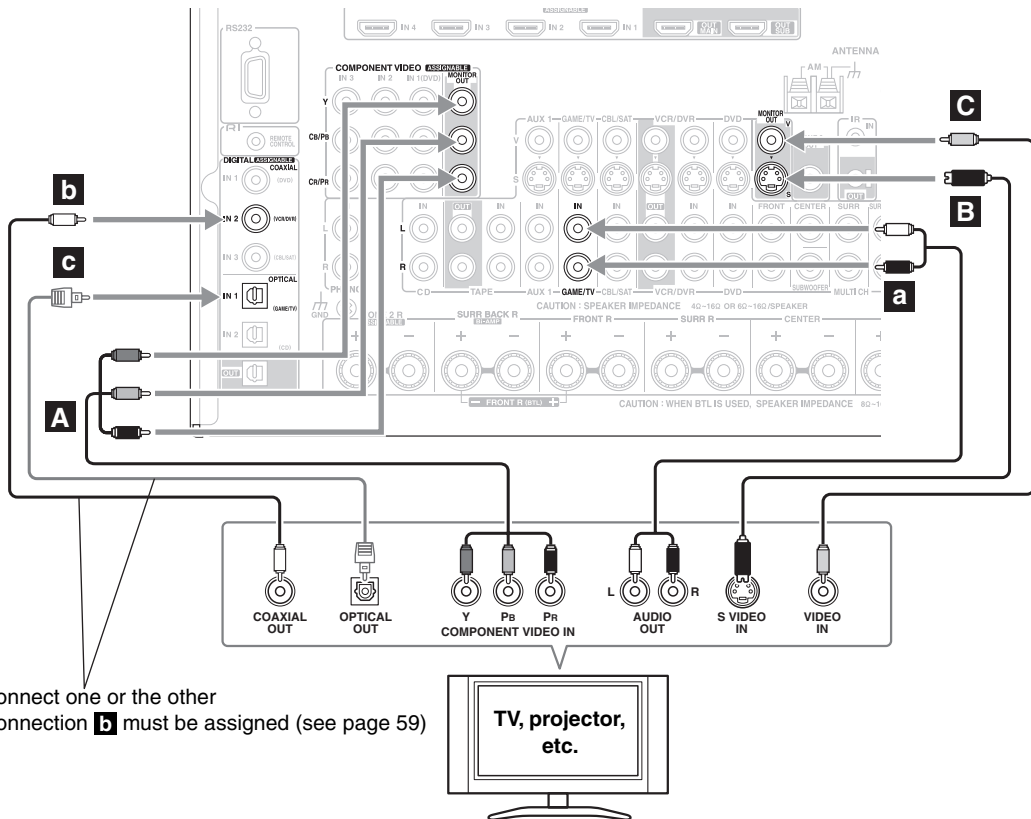

Connect one or the other
Connection **b** must be assigned (see page 59)



If your TV has no audio outputs, connect an audio output from your VCR or cable or satellite receiver to the AV receiver and use its tuner to listen to TV programs through the AV receiver (see pages 39 and 41).

Connecting the AV Receiver—Continued

Connecting a DVD player

Step 1: Video Connection

Choose a video connection that matches your DVD player (**A**, **B**, or **C**), and then make the connection.
If you use connection **A**, you must connect the AV receiver to your TV with the same type of connection.

Step 2: Audio Connection

Choose an audio connection that matches your DVD player (**a**, **b**, or **c**), and then make the connection.

- With connection **a**, you can listen to and record audio from a DVD or listen in Zone 2 or Zone 3.
- To enjoy Dolby Digital and DTS, use connection **b** or **c**. (To record or listen in Zone 2 or Zone 3 as well, use **a** and **b**, or **a** and **c**.)
- If your DVD player has main left and right outputs and multichannel left and right outputs, be sure to use the main left and right outputs for connection **a**.

Connection	AV receiver	Signal flow	DVD player
A	COMPONENT VIDEO IN 1 (DVD)	←	Component video output
B	DVD IN S	←	S-Video output
C	DVD IN V	←	Composite video output
a	DVD IN L/R	←	Analog audio L/R output
b	DIGITAL COAXIAL IN 1 (DVD)	←	Digital coaxial output
c	DIGITAL OPTICAL IN 1 (GAME/TV)	←	Digital optical output

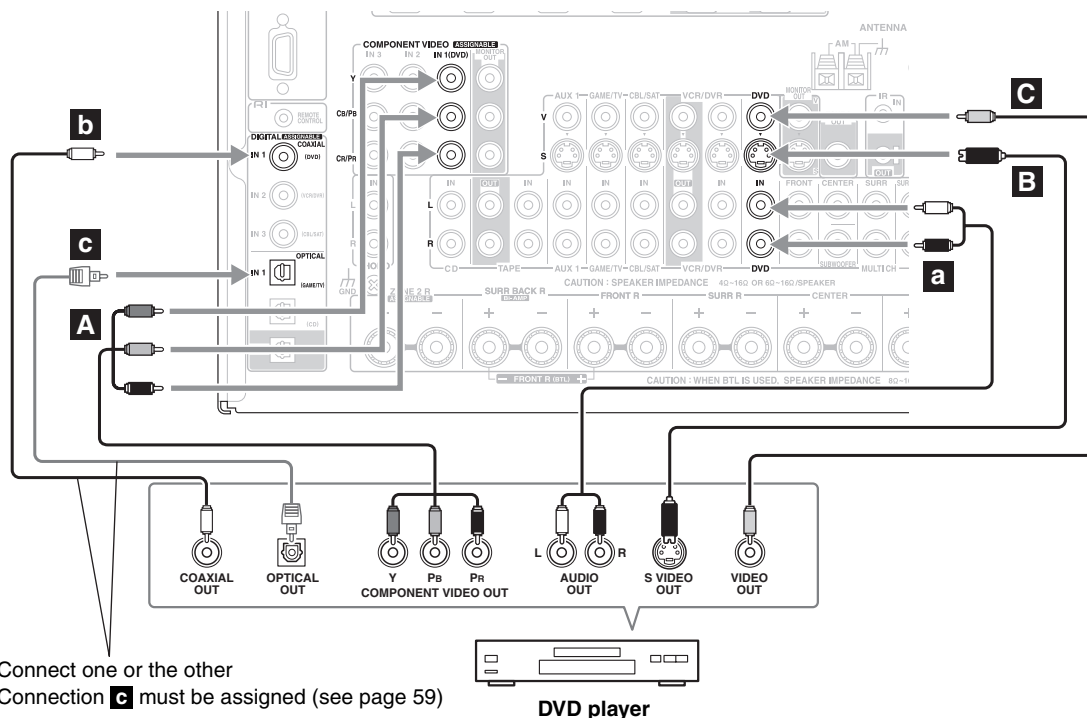

To connect a DVD player or DVD-Audio/SACD-capable player with a multichannel analog audio output, see page 38.

Connecting the AV Receiver—Continued

Hooking Up the Multichannel Input

If your DVD player supports multichannel audio formats such as DVD-Audio and SACD, and it has a multichannel analog audio output, you can connect it to the AV receiver's multichannel input.

Use a multichannel analog audio cable, or several normal audio cables, to connect the AV receiver's MULTI CH: FRONT L/R, CENTER, SURR L/R, SURR BACK L/R, and SUBWOOFER jacks to the 7.1-channel analog audio output on your DVD player. If your DVD player has a 5.1-channel analog audio output, don't connect anything to the AV receiver's SURR BACK L/R jacks.

Before using the multichannel input, you must assign it to an input selector. See "Analog Audio Input Setup" on page 60. To select the multichannel input, see "Selecting Audio Inputs" on page 120. To adjust the subwoofer sensitivity for the multichannel input, see "Subwoofer Input Sensitivity" on page 118.

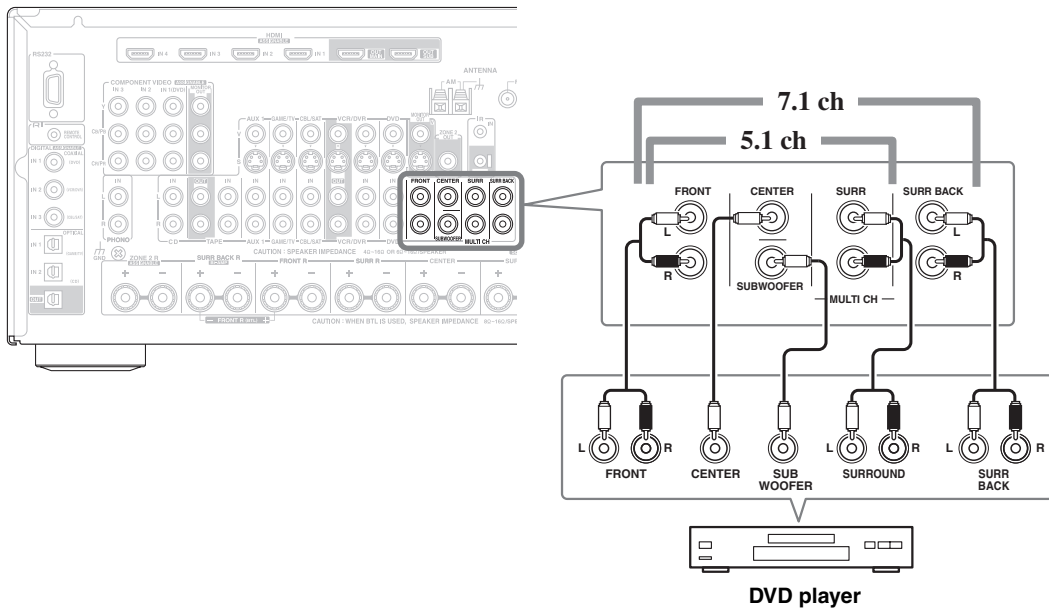

Connecting the AV Receiver—Continued

Connecting a VCR or DVD Recorder for Playback



With this hookup, you can use the tuner in your VCR or DVR to listen to your favorite TV programs via the AV receiver, which is useful if your TV has no audio outputs.

Step 1: Video Connection

Choose a video connection that matches your VCR or DVD recorder (**A**, **B**, or **C**), and then make the connection. If you use connection **A**, you must connect the AV receiver to your TV with the same type of connection.

Step 2: Audio Connection

Choose an audio connection that matches your VCR or DVD recorder (**a**, **b**, or **c**), and then make the connection.

- With connection **a**, you can listen to the VCR or DVD recorder in Zone 2 or Zone 3.
- To enjoy Dolby Digital and DTS, use connection **b** or **c**. (To listen in Zone 2 or Zone 3 as well, use **a** and **b**, or **a** and **c**.)

Connection	AV receiver	Signal flow	VCR or DVD recorder
A	COMPONENT VIDEO IN 2	←	Component video output
B	VCR/DVR IN S	←	S-Video output
C	VCR/DVR IN V	←	Composite video output
a	VCR/DVR IN L/R	←	Analog audio L/R output
b	DIGITAL COAXIAL IN 2 (VCR/DVR)	←	Digital coaxial output
c	DIGITAL OPTICAL IN 1 (GAME/TV)	←	Digital optical output

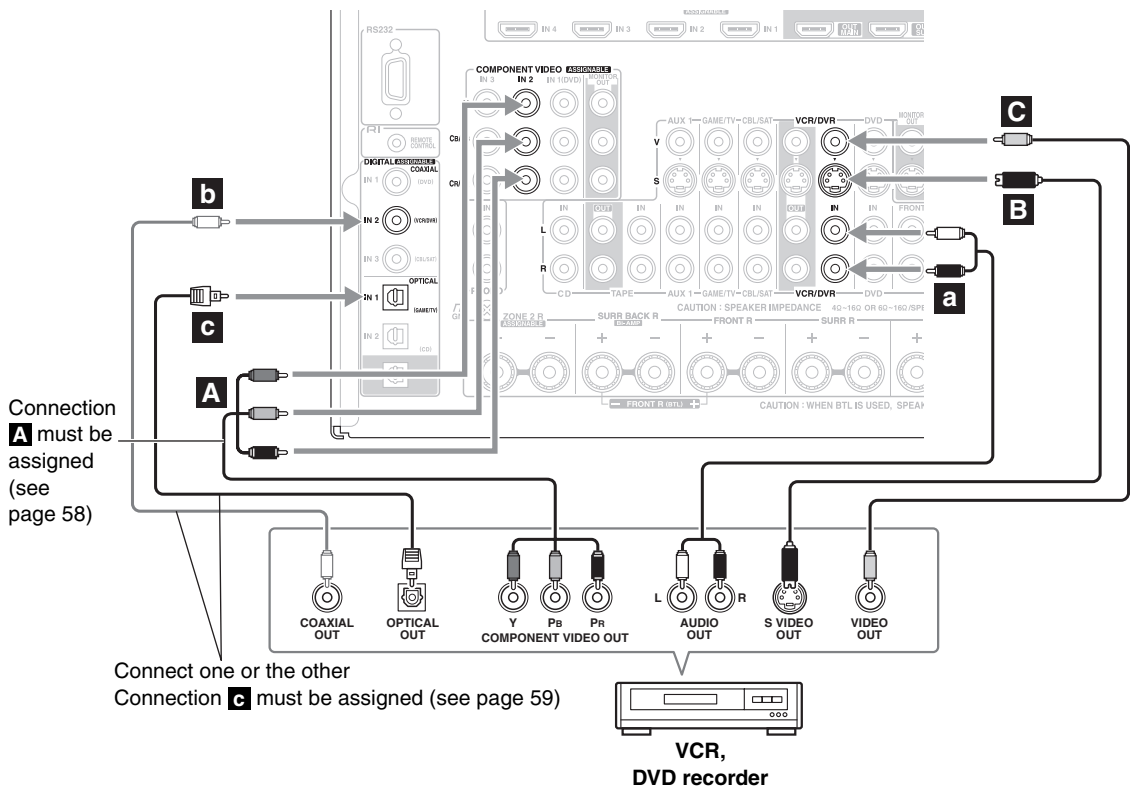

Connecting the AV Receiver—Continued

Connecting a VCR or DVD Recorder for Recording

Step 1: Video Connection

Choose a video connection that matches your VCR or DVD recorder (**A** or **B**), and then make the connection. The video source to be recorded must be connected to the AV receiver via the same type of connection.

Step 2: Audio Connection

Choose an audio connection that matches your VCR or DVD recorder (**a** or **b**), and then make the connection.

Connection	AV receiver	Signal flow	VCR or DVD recorder
A	VCR/DVR OUT S	⇒	S-Video input
B	VCR/DVR OUT V	⇒	Composite video input
a	VCR/DVR OUT L/R	⇒	Audio L/R input
b	DIGITAL OPTICAL OUT	⇒	Digital optical input

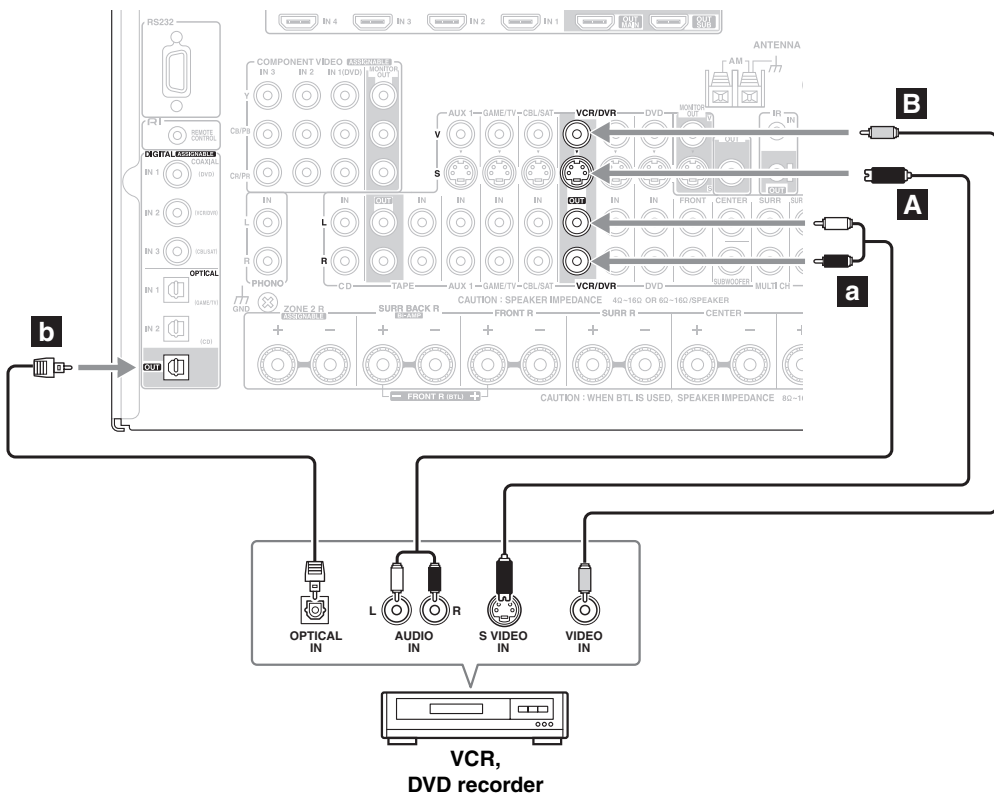

Notes:

- The AV receiver must be turned on for recording. Recording is not possible while it's on Standby mode.
- If you want to record directly from your TV or another video source without going through the AV receiver, connect the audio and video outputs from your TV or other video component directly to the recording VCR/DVD recorder's audio and video inputs. See the manuals supplied with your TV or VCR/DVD recorder for details.
- Video signals connected to composite video inputs can only be recorded via the VCR/DVR OUT V jack. So if your source TV or VCR is connected to a composite video input, the recording VCR/DVR must be connected to the VCR/DVR OUT V jack. Likewise, video signals connected to S-Video inputs can only be recorded via the VCR/DVR OUT S jack. So if your source TV or VCR is connected to an S-Video input, the recording VCR/DVD recorder must be connected to the VCR/DVR OUT S jack.

Connecting the AV Receiver—Continued

Connecting a Satellite, Cable, Terrestrial Set-top box, or Other Video Source



With this hookup, you can use your satellite or cable receiver to listen to your favorite TV programs via the AV receiver, which is useful if your TV has no audio outputs.

Step 1: Video Connection

Choose a video connection that matches the video source (**A**, **B**, or **C**), and then make the connection. If you use connection **A**, you must connect the AV receiver to your TV with the same type of connection.

Step 2: Audio Connection

Choose an audio connection that matches the video source (**a**, **b**, or **c**), and then make the connection.

- With connection **a**, you can listen to and record audio from the video source or listen in Zone 2 or Zone 3.
- To enjoy Dolby Digital and DTS, use connection **b** or **c**. (To record or listen in Zone 2 or Zone 3 as well, use **a** and **b**, or **a** and **c**.)

Connection	AV receiver	Signal flow	Video source
A	COMPONENT VIDEO IN 3	←	Component video output
B	CBL/SAT IN S	←	S-Video output
C	CBL/SAT IN V	←	Composite video output
a	CBL/SAT IN L/R	←	Analog audio L/R output
b	DIGITAL COAXIAL IN 3 (CBL/SAT)	←	Digital coaxial output
c	DIGITAL OPTICAL IN 2 (CD)	←	Digital optical output

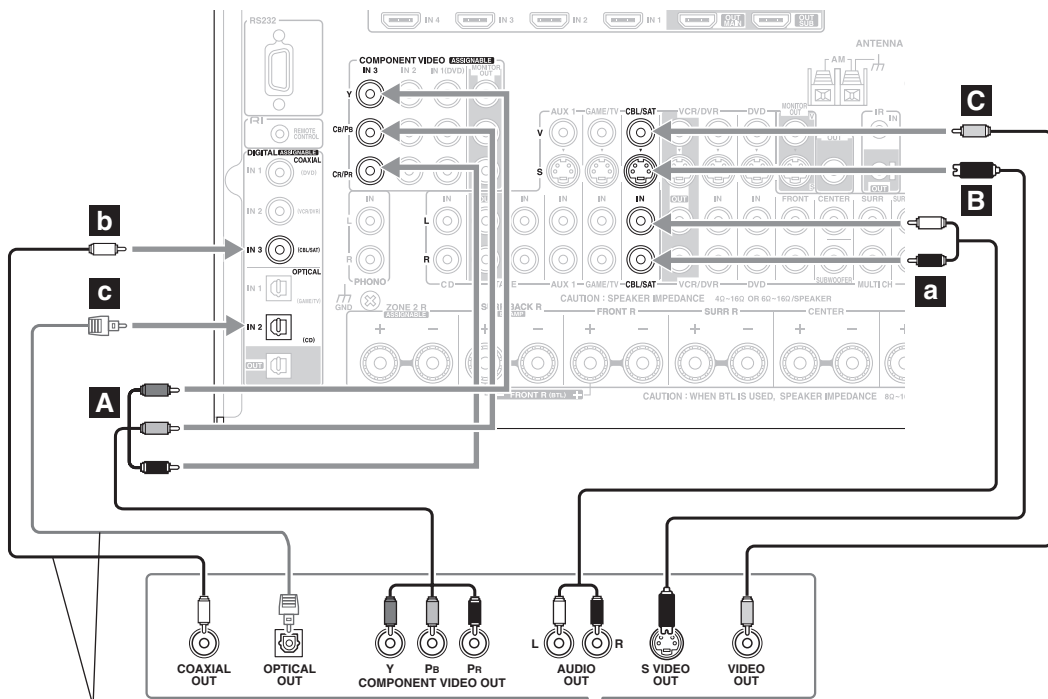

Connect one or the other
 Connection **c** must be assigned (see page 59)

Satellite, cable, set-top box, etc.

Connecting Components with HDMI

About HDMI

Designed to meet the increased demands of digital TV, HDMI (High Definition Multimedia Interface) is a new digital interface standard for connecting TVs, projectors, DVD players, set-top boxes, and other video components. Until now, several separate video and audio cables have been required to connect AV components. With HDMI, a single cable can carry control signals, digital video, and up to eight channels of digital audio (2-channel PCM, multichannel digital audio, or multichannel PCM).

The HDMI video stream (i.e., video signal) is compatible with DVI (Digital Visual Interface)^{*1}, so TVs and displays with a DVI input can be connected by using an HDMI-to-DVI adapter cable. (This may not work with some TVs and displays, resulting in no picture.)

The AV receiver uses HDCP (High-bandwidth Digital Content Protection)^{*2}, so only HDCP-compatible components will display a picture.

The AV receiver's HDMI interface is based on the following standard:

Repeater System, Deep Color, Lip Sync, DTS-HD Master Audio, DTS-HD High Resolution Audio, Dolby TrueHD, Dolby Digital Plus, SA-CD, and Multichannel PCM

Supported Audio Formats

- 2-channel linear PCM (32–192 kHz, 16/20/24 bit)
- Multichannel linear PCM (7.1 ch, 32–192 kHz, 16/20/24 bit)
- Bitstream (DSD, Dolby Digital, Dolby Digital Plus, Dolby TrueHD, DTS, DTS-HD High Resolution, DTS-HD Master Audio)

Your DVD player must be able to output these formats from its HDMI OUT.

About Copyright Protection

The AV receiver supports HDCP (High-bandwidth Digital Content Protection)^{*2}, a copy-protection system for digital video signals. Other devices connected to the AV receiver via HDMI must also support HDCP.

Use a commercially available HDMI cable (supplied with some components) to connect the AV receiver's HDMI OUT MAIN or HDMI OUT SUB to the HDMI input on your TV or projector.

*1 DVI (Digital Visual Interface): The digital display interface standard set by the DDWG^{*3} in 1999.

*2 HDCP (High-bandwidth Digital Content Protection): The video encryption technology developed by Intel for HDMI/DVI. It's designed to protect video content and requires a HDCP-compatible device to display the encrypted video.

*3 DDWG (Digital Display Working Group): Lead by Intel, Compaq, Fujitsu, Hewlett Packard, IBM, NEC, and Silicon Image, this open industry group's objective is to address the industry's requirements for a digital connectivity specification for high-performance PCs and digital displays.

Connecting the AV Receiver—Continued

Making HDMI Connections

Step 1:

Use HDMI cables to connect the AV receiver's HDMI jacks to your HDMI-compatible Blu-ray player/DVD player, TV, projector, and so on.

Step 2:

Assign each HDMI IN to an input selector. See “Video Input Setup” on page 56.

■ Video Signals

Digital video signals received by the HDMI IN jacks are normally output by the HDMI MAIN OUT and SUB OUT for display on your TV. Composite video, S-Video, and component video sources can be upconverted for the HDMI outputs. See “Video Connection Formats” on page 34 for more information.

■ Audio Signals

Digital audio signals received by the HDMI IN jacks are output by the speakers and headphones connected to the AV receiver. Normally, they are not output by the HDMI outputs, unless the “Audio TV Out” setting is set to “On” (see page 118).



To listen to audio received by the HDMI IN jacks through your TV's speakers, set the “Audio TV Out” setting to “On” (see page 118), and set your DVD player's “Audio TV Out” setting to PCM.

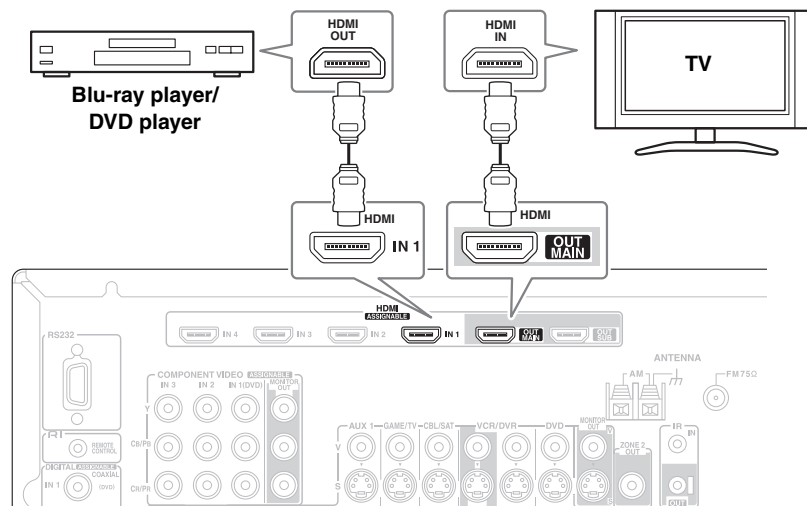

Notes:

- The HDMI video stream is compatible with DVI (Digital Visual Interface), so TVs and displays with a DVI input can be connected by using an HDMI-to-DVI adapter cable. (Note that DVI connections only carry video, so you'll need to make a separate connection for audio.) However, reliable operation with such an adapter is not guaranteed. In addition, video signals from a PC are not supported.
- When listening to an HDMI component through the AV receiver, set the HDMI component so that its video can be seen on the TV screen (on the TV, select the input of the HDMI component connected to the AV receiver). If the TV power is off or the TV is set to another input source, this may result in no sound from the AV receiver or the sound may be cut off.
- When the “Audio TV Out” setting is set to “On” (see page 118), or “TV Control” is set to “Enable” (see page 119) and you're listening through your TV's speakers, if you turn up the AV receiver volume control, the sound will be output by the AV receiver's speakers. To stop the AV receiver's speakers producing sound, change the settings, change your TV's settings, or turn down the AV receiver's volume.
- The HDMI audio signal (sampling rate, bit length, etc.) may be restricted by the connected source component. If the picture is poor or there's no sound from a component connected via HDMI, check its setup. Refer to the connected component's instruction manual for details.

Connecting the AV Receiver—Continued

Connecting a Game Console

Step 1: Video Connection

Choose a video connection that matches your game console (**A**, **B**, or **C**), and then make the connection.

If you use connection **A**, you must connect the AV receiver to your TV with the same type of connection.

Step 2: Audio Connection

Choose an audio connection that matches your DVD player (**a**, **b**, or **c**), and then make the connection.

- With connection **a**, you can listen to and record audio from your game console or listen in Zone 2 or Zone 3.
- To enjoy Dolby Digital and DTS, use connection **b**. (To record or listen in Zone 2 or Zone 3 as well, use **a** and **b**.)

Connection	AV receiver	Signal flow	Game console
A	COMPONENT VIDEO IN 3	←	Component video output
B	GAME/TV IN S	←	S-Video output
C	GAME/TV IN V	←	Composite video output
a	GAME/TV IN L/R	←	Analog audio L/R output
b	DIGITAL OPTICAL IN 1 (GAME/TV)	←	Digital coaxial output

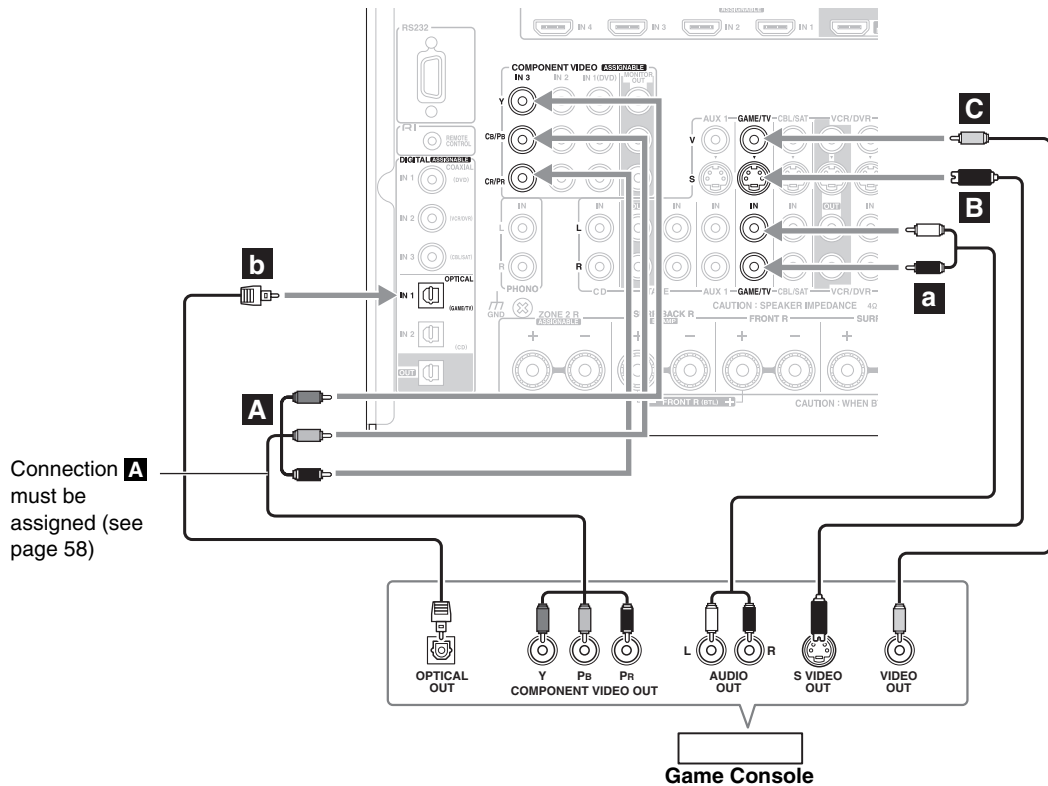

Connecting the AV Receiver—Continued

Connecting a Camcorder or Other Device

Step 1: Video Connection

Choose a video connection that matches your camcorder (**A** or **B**), and then make the connection.

Step 2: Audio Connection

Choose an audio connection that matches your camcorder (**a** or **b**), and then make the connection.

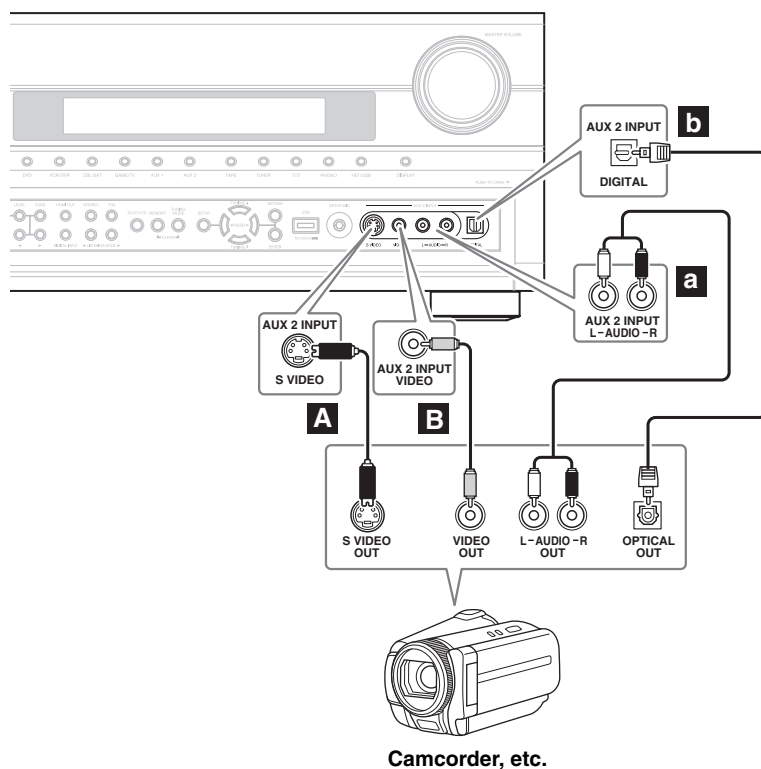

Connection	AV receiver	Signal flow	Camcorder
A	AUX 2 INPUT S VIDEO	←	S-Video output
B	AUX 2 INPUT VIDEO	←	Composite video output
a	AUX 2 INPUT L-AUDIO-R	←	Analog audio L/R output
b	AUX 2 INPUT DIGITAL	←	Digital optical output

Connecting a CD Player or Turntable

■ CD Player or Turntable (MM) with Built-in Phono Preamp

Step 1:

Choose a connection that matches your CD player (**a**, **b**, or **c**). Use connection **a** for a turntable with a built-in phono preamp.

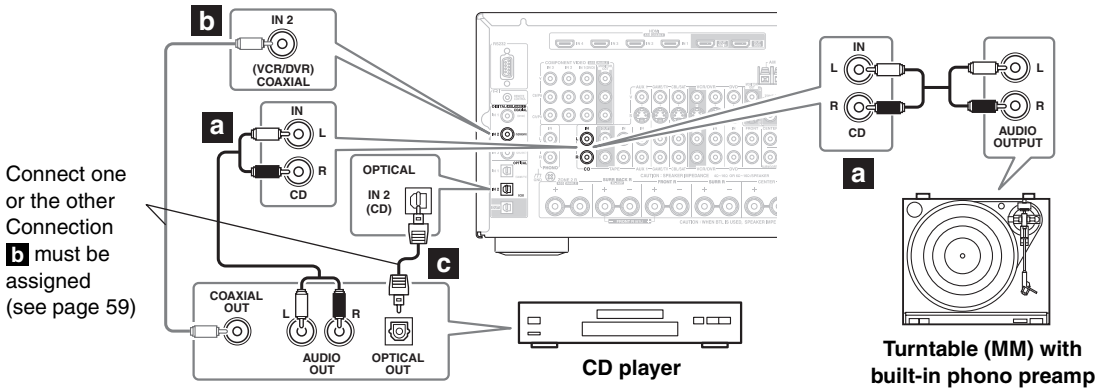

- With connection **a**, you can listen to and record audio from the CD player or listen in Zone 2 or Zone 3.
- To connect the CD player digitally, use connection **b** or **c**. (To record or listen in Zone 2 or Zone 3 as well, use **a** and **b**, or **a** and **c**.)

Connection	AV receiver	Signal flow	CD or turntable
a	CD IN L/R	←	Analog audio L/R output
b	DIGITAL COAXIAL IN 2 (VCR/DVR)	←	Digital coaxial output
c	DIGITAL OPTICAL IN 2 (CD)	←	Digital optical output

■ Turntable (MM) with no Phono Preamp Built-in

The AV receiver's PHONO IN is designed for use with a moving magnet (MM) type cartridge.

Use an analog audio cable to connect the AV receiver's PHONO IN L/R jacks to the audio output on your turntable.

Notes:

- If your turntable has a ground wire, connect it to the AV receiver's GND screw. With some turntables, connecting the ground wire may produce an audible hum. If this happens, disconnect it.
- If your turntable has a moving coil (MC) type cartridge, you'll need a commercially available MC head amp or MC transformer. Connect your turntable to the head amp or transformer, and connect that to the AV receiver's PHONO IN L/R jacks.
- You can also use a phono equalizer to connect a turntable with an MC-type cartridge. See your phono equalizer's manual for details.

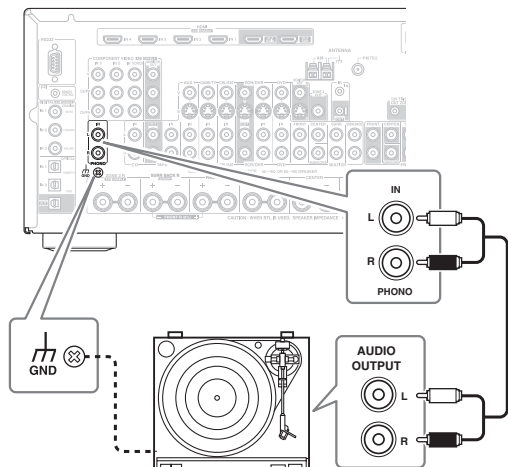

Connecting the AV Receiver—Continued

Connecting a Cassette, CDR, MiniDisc, or DAT Recorder

Step 1:

Choose a connection that matches your recorder (**a**, **b**, **c**, or **d**), and then make the connection.

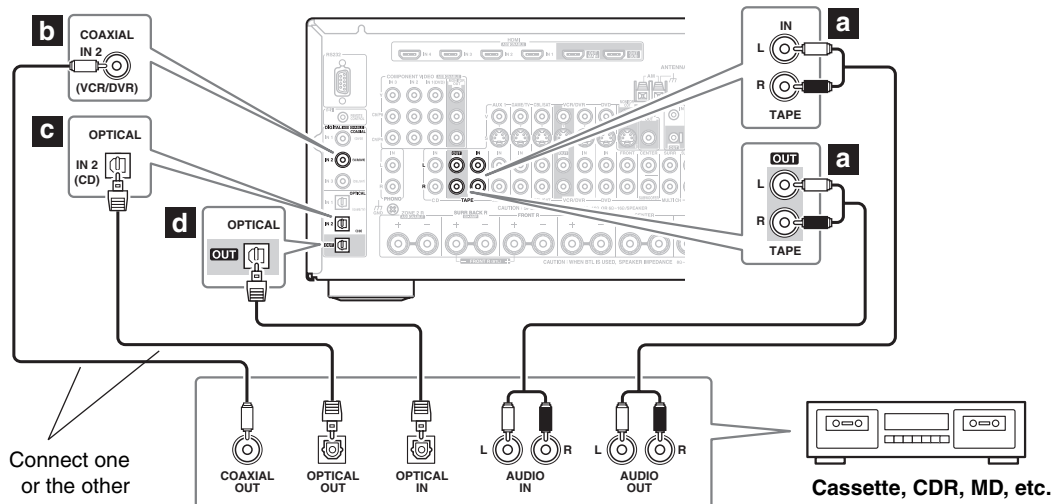

- With connection **a**, you can play and record or listen in Zone 2 or Zone 3.
- To connect the recorder digitally for playback, use connections **a** and **b**, or **a** and **c**.
- To connect the recorder digitally for recording, use connection **d**.

Connection	AV receiver	Signal flow	Cassette, CDR, MD, or DAT recorder
a	TAPE IN L/R TAPE OUT L/R	← →	Analog audio L/R output Analog audio L/R input
b	DIGITAL COAXIAL IN 2 (VCR/DVR)	←	Digital coaxial output
c	DIGITAL OPTICAL IN 2 (CD)	←	Digital optical output
d	DIGITAL OPTICAL OUT	→	Digital optical input

Connecting the AV Receiver—Continued

Connecting a Power Amplifier

If you want to use a more powerful power amplifier and use the AV receiver solely as a preamp, connect the amp to the PRE OUT jacks, and connect all speakers and the subwoofer to the power amplifier. If you have a powered subwoofer, connect it to the AV receiver's PRE OUT: SUBWOOFER jack.

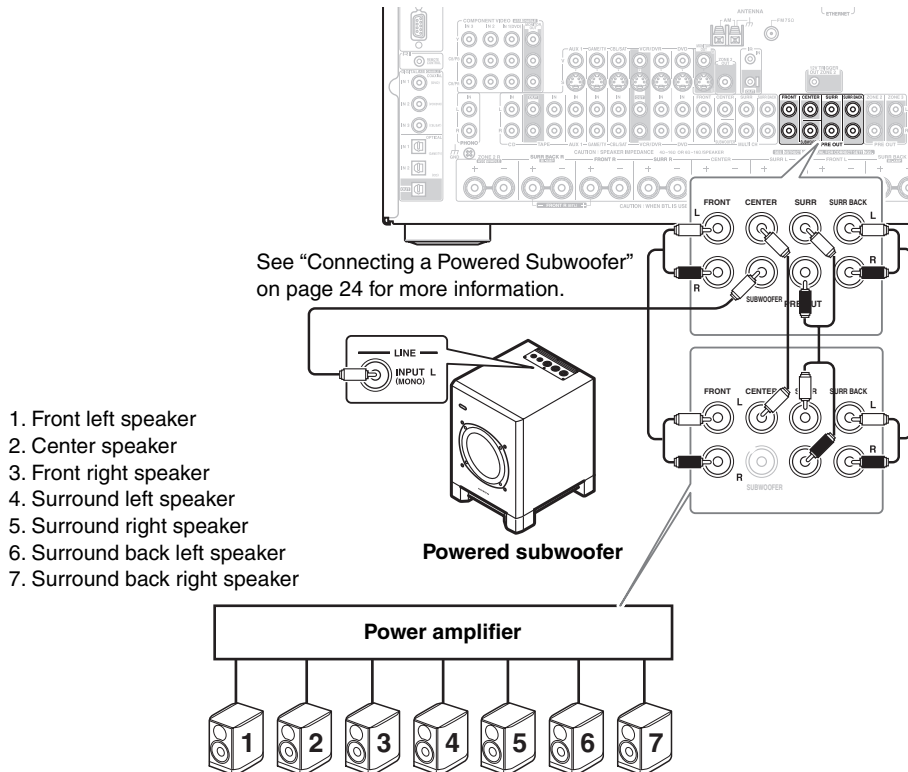

Connecting the AV Receiver—Continued

Connecting an RI Dock

Not all iPod models output video. For information about which iPod models are supported by the RI Dock, see the RI Dock's instruction manual.

■ If Your iPod Supports Video:

Connect your RI Dock's audio output jacks to the AV receiver's AUX 1 IN L/R jacks, and connect its video output jack to the AV receiver's AUX 1 IN V jack.

(Onkyo DS-A2X hookup shown below.)

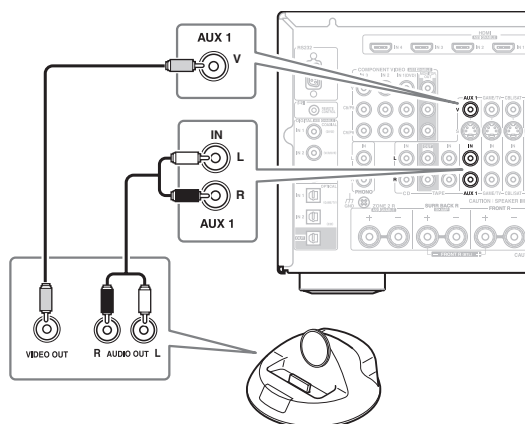

■ If Your iPod Doesn't Support Video:

Connect your RI Dock's audio output jacks to the AV receiver's AUX 1 IN L/R jacks.

(Onkyo DS-A2X hookup shown below.)

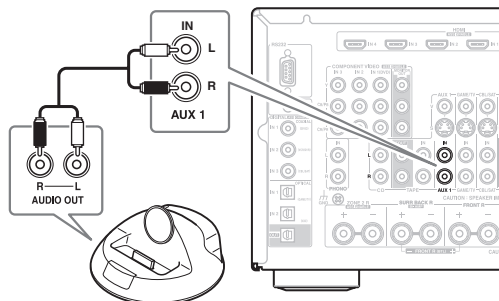

■ If you have an Onkyo DS-A1 RI Dock

- Connect its video output jack to the AV receiver's AUX 1 jack.

Notes:

- Connect the RI Dock to the AV receiver with an **RI** cable (see page 50).
- Set the RI Dock's RI MODE switch to "HDD" or "HDD/DOCK".
- Set the AV receiver's Input Display to "DOCK" (see page 63).
- By using the [CD] (TX-NR906) or [DOCK] (TX-SR876) REMOTE MODE button on the remote controller of the AV receiver to change the remote mode to "DOCK", you can operate your iPod in the RI Dock (see page 20). If you cannot operate it, you will need to enter the appropriate remote control code (see page 137).
- See the RI Dock's instruction manual for more information.

Connecting the Power Cords of Other Components (North American model only)

The AV receiver has AC outlet on its rear panel that can be used to connect the power cords of other components that you intend to use with the AV receiver. These components can then be left turned on so that they turn on and off as and when the AV receiver is set to On or Standby.

Caution:

- Make sure that the total capacity of the components that you connect to the AC OUTLET does not exceed the stated capacity.

Notes:

- When the "HDMI Control" setting is set to "Enable" (page 118), the AC outlet are on all the time regardless of whether the AV receiver is set to On or Standby, or Ready mode in this case, so any components connected to them cannot be turned on or off automatically.
- Onkyo components connected via **RI** should be connected directly to a wall outlet, not an AC OUTLET on the AV receiver.

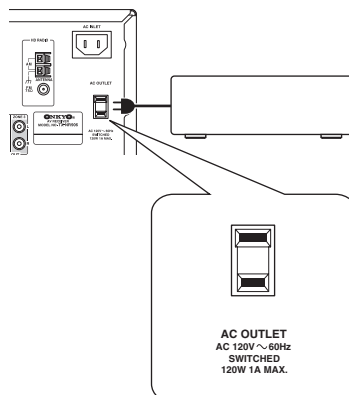

North American model

Connecting the AV Receiver—Continued

Connecting Onkyo **RI** Components

Step 1: Make sure that each Onkyo component is connected to the AV receiver with an analog audio cable (RCA).

Step 2: Make the necessary **RI** connections (see illustration below).

Step 3: If you're using an MD, CDR, or RI DOCK component, change the Input Display (see page 63).

With **RI** (Remote Interactive), you can use the following special functions:

Auto Power On/Standby

When you start playback on a component connected via **RI**, if the AV receiver is on Standby, it will automatically turn on and select that component as the input source. Similarly, when the AV receiver is set to Standby, all components connected via **RI** will also go on Standby. This function will not work with components that are connected to an AC OUTLET on the AV receiver.

Direct Change

When playback is started on a component connected via **RI**, the AV receiver automatically selects that component as the input source. If your DVD player is connected to the AV receiver's multichannel input, you'll need to press the [AUDIO SEL] button repeatedly and select Multich to hear all channels (see page 80), as the Direct Change **RI** function selects the DVD IN L/R jacks.

Remote Control

You can use the AV receiver's remote controller to control your other **RI**-capable Onkyo components. You must enter the appropriate remote control code first (see page 138). And remember to point the remote controller at the AV receiver and not the other component.

Notes:

- Use only **RI** cables for **RI** connections. **RI** cables are supplied with Onkyo players (DVD, CD, etc.).
- Some components have two **RI** jacks. You can connect either one to the AV receiver. The other jack is for connecting additional **RI**-capable components.
- Connect only Onkyo components to **RI** jacks. Connecting other manufacturer's components may cause a malfunction.
- Some components may not support all **RI** functions. Refer to the manuals supplied with your other Onkyo components.
- While Zone 2 or Zone 3 is on, the Auto Power On/Standby and Direct Change **RI** functions do not work.

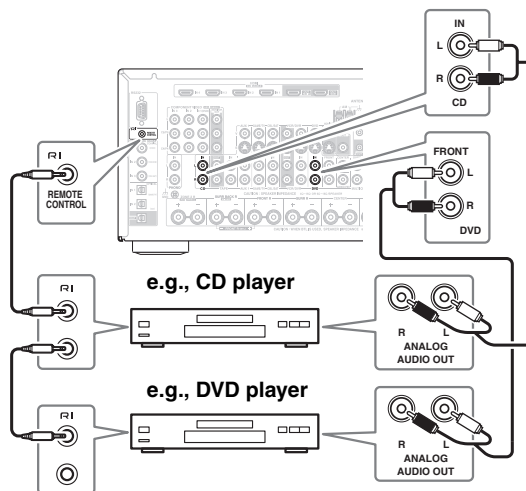

Connecting the Power Cord

- **Before connecting the power cord, connect all your speakers and AV components.**
- Connect the power cord to the AV receiver's AC INLET.
- Plug the other end of the power cord into a suitable wall outlet.
- Turning on the AV receiver may cause a momentary power surge that might interfere with other electrical equipment on the same circuit. If this is a problem, plug the AV receiver into a different branch circuit.

Turning On the AV Receiver

• North American model

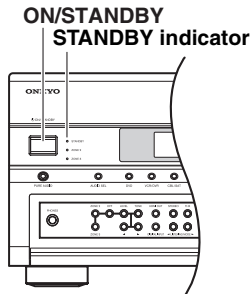

• Other models

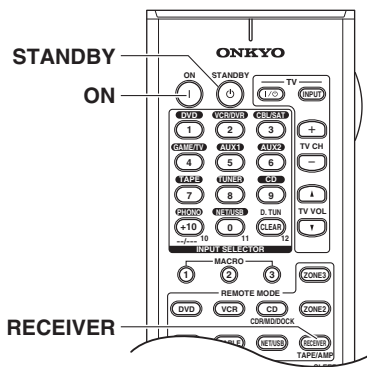
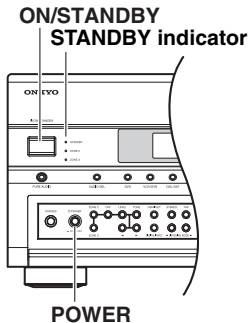

Turning On and Standby



Set the [POWER] switch to the ON position (●).
 (Skip this step if you have the North American model.)
 The AV receiver enters Standby mode, and the STANDBY indicator comes on.

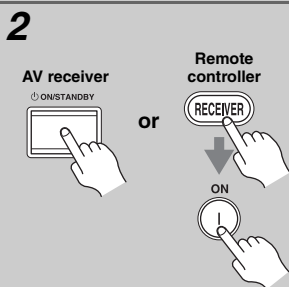

On the AV receiver, press the [ON/STANDBY] button.
 On the remote controller, press the [RECEIVER] REMOTE MODE button, followed by the [ON] button.
 The AV receiver comes on, the display lights up, and the STANDBY indicator goes off. Pressing the remote controller's [ON] button again will turn on any components connected via **RI**.

To turn the AV receiver off, press the [ON/STANDBY] button, or press the remote controller's [STANDBY] button. The AV receiver will enter Standby mode. To prevent any loud surprises the next time you turn on the AV receiver, turn down the volume before you turn it off.

For non-North American models: To completely shut down the AV receiver, set the [POWER] switch to the OFF position (■).

Up and Running in a Few Easy Steps

To get your system up and running with the minimum of fuss, here's a few pointers to help you configure the AV receiver before you use it for the very first time. These settings only need to be made once.

■ **Do the automatic speaker setup—this is essential!**

See "Automatic Speaker Setup (Audyssey MultEQ® XT)" on page 64.



■ **Did you connect your TV to an HDMI OUT or COMPONENT VIDEO MONITOR OUT?**

If you did, see "Monitor Out Setup" on page 55.



■ **Did you connect a component to an HDMI input, component video input, or digital audio input?**

If you did, see "Video Input Setup" on page 56, "Component Video Setup" on page 58, or "Digital Audio Input Setup" on page 59 respectively.

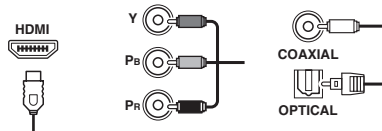

■ **Did you connect an Onkyo MD recorder, CD recorder, or RI Dock?**

If you did, see "Changing the Input Display" on page 63.

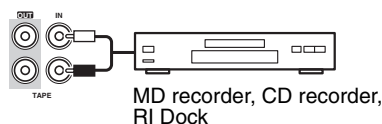

First Time Setup

This section explains the settings that you need to make before using the AV receiver for the very first time.

Monitor Setup

On the “Monitor Out” settings, you can select whether or not to have the video sources’ images output through the HDMI OUT, as well as whether to have the onscreen setup menu output through the HDMI OUT or through an analog output.

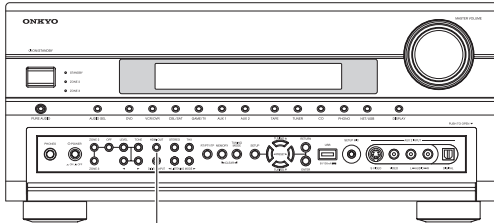

1, 2

If you connect your TV to the COMPONENT VIDEO MONITOR OUT, set the “Monitor Out” setting to “Analog” so that the onscreen setup menus are displayed and composite video and S-Video sources are upconverted* and output by the COMPONENT VIDEO MONITOR OUT.

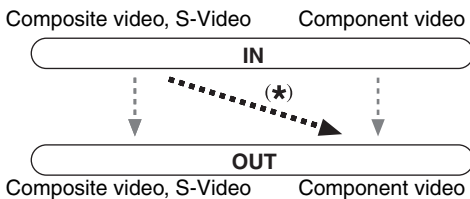

If you connect your TV to the HDMI OUT MAIN or HDMI OUT SUB, set the “Monitor Out” setting to “HDMI Main” or “HDMI Sub” so that the onscreen setup menus are displayed and composite video, S-Video, and component video sources are upconverted* and output by the HDMI OUT MAIN or HDMI OUT SUB. The onscreen setup menus are displayed on the HDMI OUT MAIN or HDMI OUT SUB only.

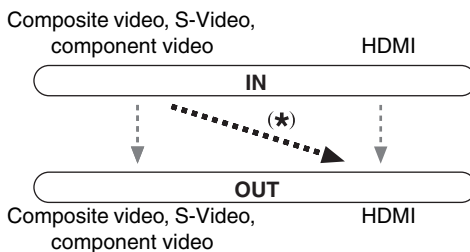

You can specify the output resolution for the HDMI OUT MAIN or HDMI OUT SUB and COMPONENT VIDEO MONITOR OUT and have the AV receiver upconvert the picture resolution as necessary to match the resolution supported by your TV (see page 111).

1

HDMI OUT



Press the [HDMI OUT] button.
The current setting is displayed.

Monitor Out

#HDMI Main

2

HDMI OUT



Press the [HDMI OUT] button repeatedly to select:

Analog:
Select this if your TV is connected to the COMPONENT VIDEO MONITOR OUT, S MONITOR OUT, or V MONITOR OUT.

HDMI Main:
Select this if your TV is connected to the HDMI OUT MAIN.

HDMI Sub:
Select this if your TV is connected to the HDMI OUT SUB.

Note:
When “HDMI Main” or “HDMI Sub” is selected, the onscreen setup menus are output by only the HDMI outputs.
If you’re not using the HDMI outputs and select “HDMI Main” or “HDMI Sub” by mistake and the menus disappear, press the [HDMI OUT] button to select “Analog”.

Note:

See page 34 for charts showing how the “Monitor Out” and “Resolution” (see pages 55, 56) settings affect the video signal flow through the AV receiver.

First Time Setup—Continued

In this Instruction Manual, illustrations from the onscreen menu or explanations referring to the menu will be in the same language as the Instruction Manual. The default Language setting for the onscreen menu is English. If your Instruction Manual is in a language other than English, first follow the instructions below to change the Language.

Selecting the Language used for the onscreen setup menus

This setting determines the language used for the onscreen setup menus. You can select: English, German, French, Spanish, Italian, Dutch, Swedish, or Japanese.

1



Press the [RECEIVER] button, followed by the [SETUP] button.

The main menu appears onscreen.

If the main menu doesn't appear, make sure the appropriate external input is selected on your TV.

2

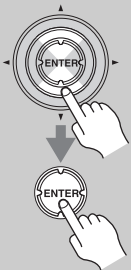

Use the Up and Down [▲]/[▼] buttons to select “6. Miscellaneous”, and then press [ENTER].

The “Miscellaneous” menu appears.

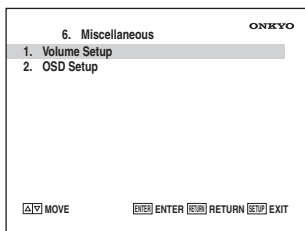

3

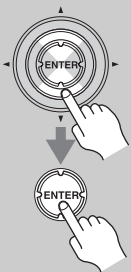

Use the Up and Down [▲]/[▼] buttons to select “2. OSD Setup”, and then press [ENTER].

The “OSD Setup” menu appears.

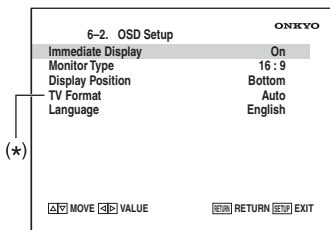

Note:

The “TV Format” (*) setting is not available on the North American models.

4

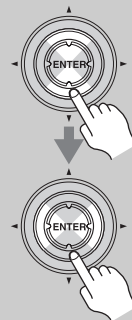

Use the Up and Down [▲]/[▼] buttons to select “Language”, and then use the Left and Right [◀]/[▶] buttons to select: English, German, French, Spanish, Italian, Dutch, Swedish, Japanese

5



Press the [SETUP] button.

The setup menu closes.

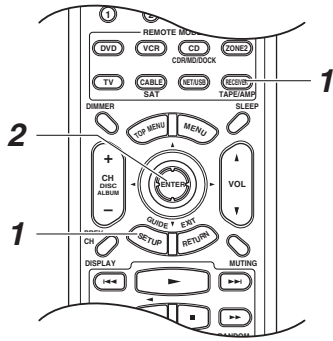

Using the Onscreen Setup Menus

Carry out the settings for the AV receiver by using the Onscreen Setup Menu.

1

Press the [RECEIVER] button followed by the [SETUP] button.

The main menu appears onscreen.

If the main menu doesn't appear, make sure the appropriate external input is selected on your TV.



MENU ONKYO

1. Input/Output Assign
2. Speaker Setup
3. Audio Adjust
4. Source Setup
5. Listening Mode Preset
6. Miscellaneous
7. Hardware Setup
8. Lock Setup

[MOVE] MOVE [ENTER] ENTER [RETURN] RETURN [EXIT] EXIT

2

Use the Up and Down [▲]/[▼] buttons to select submenu and then press [ENTER].

The submenu appears.

Press the [SETUP] button to close the menu.

Press the [RETURN] button to return to the previous menu.

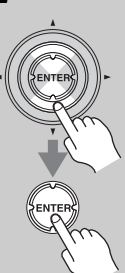

Menus for First Time Setup

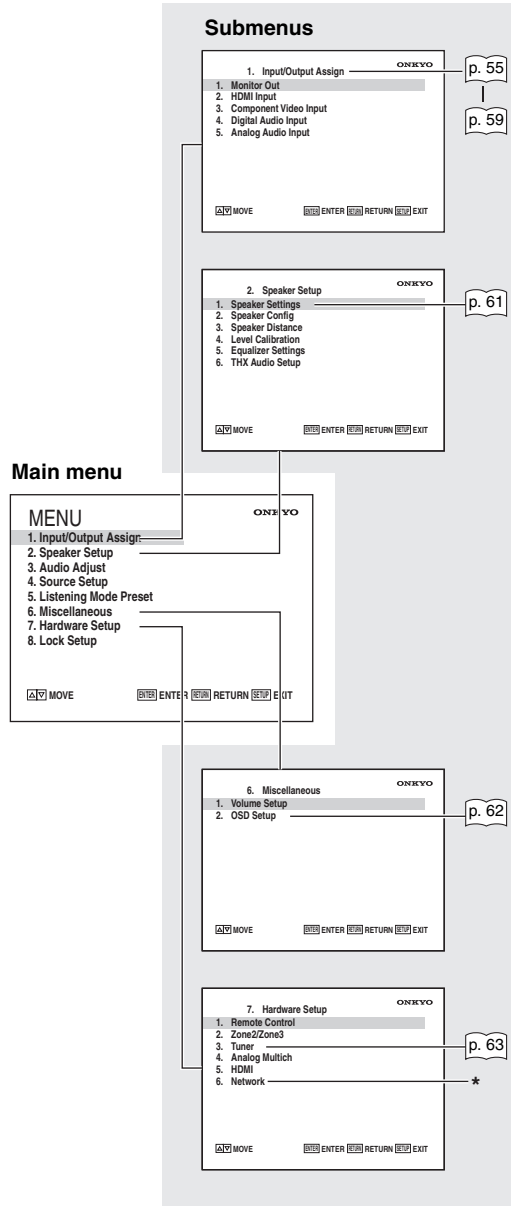

Monitor Out Setup

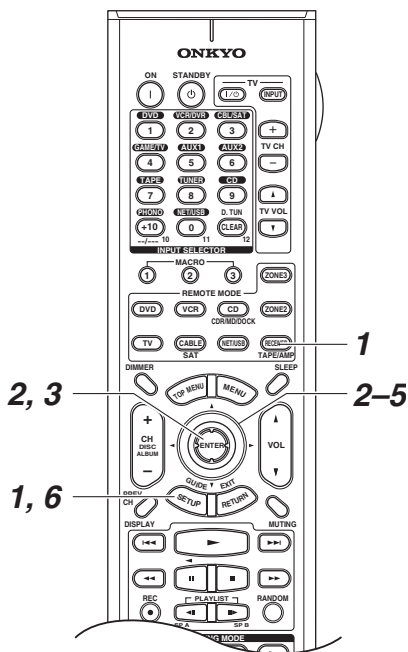

If you connect your TV to the COMPONENT VIDEO MONITOR OUT, set the “Monitor Out” setting to “Analog” so that the onscreen setup menus are displayed and composite video and S-Video sources are upconverted and output by the COMPONENT VIDEO MONITOR OUT.

If you connect your TV to the HDMI OUT MAIN or HDMI OUT SUB, set the “Monitor Out” setting to “HDMI Main” or “HDMI Sub”, respectively, so that the onscreen setup menus are displayed and composite video, S-Video, and component video sources are upconverted and output by the HDMI OUT MAIN or HDMI OUT SUB.

You can specify the output resolution for the HDMI outputs and COMPONENT VIDEO MONITOR OUT and have the AV receiver upconvert the picture resolution as necessary to match the resolution supported by your TV.

1

Press the [RECEIVER] button, followed by the [SETUP] button.

The main menu appears onscreen.

If the main menu doesn't appear, make sure the appropriate external input is selected on your TV.



2

Use the Up and Down [▲]/[▼] buttons to select “1. Input/Output Assign”, and then press [ENTER].

The “Input/Output Assign” menu appears.

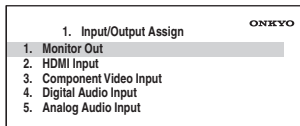
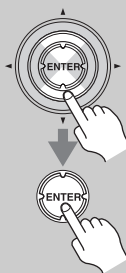

3

Use the Up and Down [▲]/[▼] buttons to select “1. Monitor Out”, and then press [ENTER].

The “Monitor Out” menu appears.

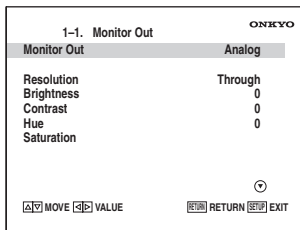
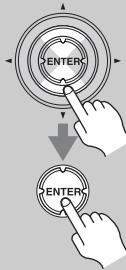

4

Use the Up and Down [▲]/[▼] buttons to select “Monitor Out”, and use the Left and Right [◀]/[▶] buttons to select:

Analog:

Select this if your TV is connected to the COMPONENT VIDEO MONITOR OUT, S MONITOR OUT, or V MONITOR OUT.

HDMI Main:

Select this if your TV is connected to the HDMI OUT MAIN.

HDMI Sub:

Select this if your TV is connected to the HDMI OUT SUB.

Note:

When “HDMI Main” or “HDMI Sub” is selected, the onscreen setup menus are output by only the HDMI outputs. If you're not using the HDMI outputs and select “HDMI Main” or “HDMI Sub” by mistake and the menus disappear, press the AV receiver's [HDMI OUT] button so that “Monitor Out: Analog” appears on the display.



5

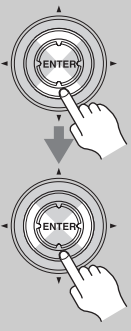

Use the Up and Down [▲]/[▼] buttons to select “Resolution”, and use the Left and Right [◀]/[▶] buttons to select:

Through:
Select this to pass video through the AV receiver at the same resolution and with no conversion.

Auto:
Select this to have the AV receiver automatically convert video at resolutions not supported by your TV. (Not available when the “Monitor Out” setting is set to “Analog”.)

480p:
Select this for 480p output and video conversion as necessary.

720p:
Select this for 720p output and video conversion as necessary.

1080i:
Select this for 1080i output and video conversion as necessary.

1080p:
Select this for 1080p output and video conversion as necessary. (Not available when the “Monitor Out” setting is set to “Analog”.)

Source:
Output will be according to the resolution level which was set with Resolution inside Source: 4-4. Picture Adjust. (Setting for each Source becomes possible.)

6



Press the [SETUP] button.
Setup closes.

- Notes:**
- See page 35 for charts showing how the “Monitor Out” and “Resolution” settings affect the video signal flow through the AV receiver.
 - This procedure can also be performed on the AV receiver by using its [SETUP] button, arrow buttons, and [ENTER] button.

Video Input Setup

HDMI Input Setup

If you connect a video component to an HDMI IN, you must assign that input to an input selector. For example, if you connect your DVD player to HDMI IN 1, you must assign HDMI IN 1 to the DVD input selector. By default, none of the HDMI inputs are assigned.

If you’ve connected your TV to the AV receiver with an HDMI cable, you can set the AV receiver so that composite video, S-Video, and component video sources are upconverted* and output by the HDMI outputs. You can set this for each input selector by selecting the “- - -” option.

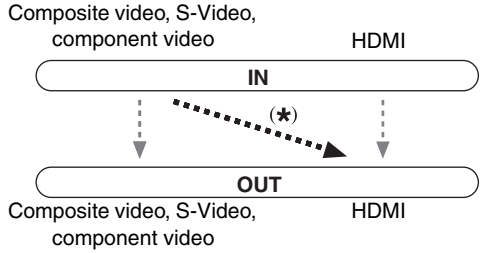

1



Press the [RECEIVER] button, followed by the [SETUP] button.
The main menu appears onscreen.
If the main menu doesn’t appear, make sure the appropriate external input is selected on your TV.

2



Use the Up and Down [▲]/[▼] buttons to select “1. Input/Output Assign”, and then press [ENTER].
The “Input/Output Assign” menu appears.

ONKYO

1. Input/Output Assign

1. Monitor Out
2. HDMI Input
3. Component Video Input
4. Digital Audio Input
5. Analog Audio Input

3

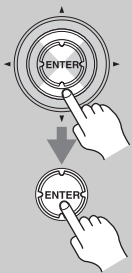

Use the Up and Down [▲]/[▼] buttons to select “2. HDMI Input”, and then press [ENTER].

The “HDMI Input” menu appears.

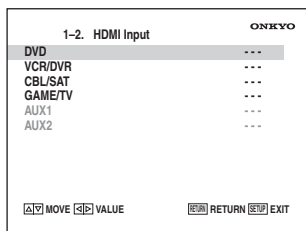

- This procedure can also be performed on the AV receiver by using its [SETUP] button, arrow buttons, and [ENTER] button.

4

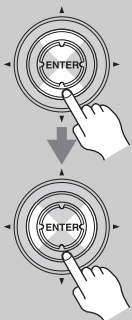

Use the Up and Down [▲]/[▼] buttons to select an input selector, and use the Left and Right [◀]/[▶] buttons to select:

HDMI1, HDMI2, HDMI3, HDMI4:

Select the HDMI IN to which the video component has been connected.

---:

Output composite video, S-Video, and component video sources from the HDMI OUT. The video output signal from the HDMI OUT is the one configured in “Component Video Setup” (see page 58).

Each HDMI IN cannot be assigned to more than one input selector. When HDMI1 - HDMI4 have already been assigned, you must set first any unused input selectors to “- - -” or you will be unable to assign HDMI1 - HDMI4 to input selector.

5



Press the [SETUP] button.

Setup closes.

Notes:

- For composite video, S-Video, and component video upconversion for the HDMI OUT MAIN or HDMI OUT SUB, the “Monitor Out” setting must be set to “HDMI Main” or “HDMI Sub”, respectively (see page 55), and the “HDMI Input” setting must be set to “- - -”. See page 34 for more information on video signal flow and upconversion.
- When an HDMI IN is assigned to an input selector as explained here, the digital audio input for that input selector is automatically set to the same HDMI IN. See “Digital Audio Input Setup” on page 59.
- The “TUNER” input selector cannot be assigned and is fixed at the “- - -” option.

Component Video Setup

If you connect a video component to a COMPONENT VIDEO IN, you must assign that input to an input selector. For example, if you connect your DVD player to COMPONENT VIDEO IN 3, you must assign COMPONENT VIDEO IN 3 to the DVD input selector.

By default, the DVD input selector is assigned to COMPONENT VIDEO IN 1, and all of the other input selectors are assigned to the “- - -” option.

Input selector	Default assignment
DVD	IN1
VCR/DVR	- - -
CBL/SAT	- - -
GAME/TV	- - -
AUX1	- - -
AUX2	- - -
TAPE	- - -
TUNER	- - - (Fixed)
CD	- - -
PHONO	- - -

If you’ve connected your TV to the AV receiver with a component video cable, you can set the AV receiver so that composite video and S-Video sources are upconverted* and output by the COMPONENT VIDEO MONITOR OUT. You can set this for each input selector by selecting the “- - -” option.

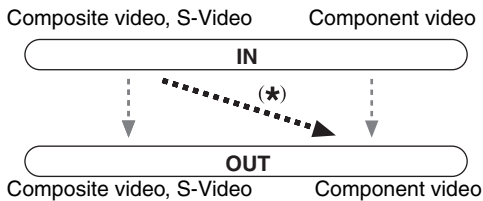

1 Press the [RECEIVER] button, followed by the [SETUP] button. The main menu appears onscreen. If the main menu doesn’t appear, make sure the appropriate external input is selected on your TV.

2 Use the Up and Down [▲]/[▼] buttons to select “1. Input/Output Assign”, and then press [ENTER]. The “Input/Output Assign” menu appears.

ONKYO

1. Input/Output Assign

- 1. Monitor Out
- 2. HDMI Input
- 3. Component Video Input
- 4. Digital Audio Input
- 5. Analog Audio Input

3 Use the Up and Down [▲]/[▼] buttons to select “3. Component Video Input”, and then press [ENTER]. The “Component Video Input” menu appears.

ONKYO

1-3. Component Video Input

DVD	IN1
VCR/DVR	- - -
CBL/SAT	- - -
GAME/TV	- - -
AUX1	- - -
AUX2	- - -

▲▼ MOVE □ VALUE ⏪ RETURN ⏩ EXIT

4 Use the Up and Down [▲]/[▼] buttons to select an input selector, and use the Left and Right [◀]/[▶] buttons to select:

- IN1:** Use the video component connected to COMPONENT VIDEO IN 1.
- IN2:** Use the video component connected to COMPONENT VIDEO IN 2.
- IN3:** Use the video component connected to COMPONENT VIDEO IN 3.
- - -:** Output composite video and S-Video sources from the COMPONENT VIDEO MONITOR OUT.

5 Press the [SETUP] button. Setup closes.

- Notes:**
- For composite video and S-Video upconversion for the COMPONENT VIDEO MONITOR OUT, the “Monitor Out” setting must be set to “Analog” (see page 55), and the “Component Video Input” setting must be set to “- - -”. See page 35 for more information on video signal flow and upconversion.
 - This procedure can also be performed on the AV receiver by using its [SETUP] button, arrow buttons, and [ENTER] button.

Digital Audio Input Setup

If you connect a component to a digital audio input, you must assign that input to an input selector. For example, if you connect your CD player to OPTICAL IN 2, you must assign OPTICAL IN 2 to the “CD” input selector. Here are the default assignments.

Input selector	Default assignment
DVD	COAX1
VCR/DVR	COAX2
CBL/SAT	COAX3
GAME/TV	OPT1
AUX1	- - -
AUX2	FRONT (Fixed)
TAPE	- - -
TUNER	- - - (Fixed)
CD	OPT2
PHONO	- - -

1 Press the [RECEIVER] button, followed by the [SETUP] button.



The main menu appears onscreen. If the main menu doesn't appear, make sure the appropriate external input is selected on your TV.

2 Use the Up and Down [▲]/[▼] buttons to select “1. Input/Output Assign”, and then press [ENTER].

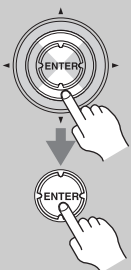

The “Input/Output Assign” menu appears.

1. Input/Output Assign		ONKYO
1. Monitor Out		
2. HDMI Input		
3. Component Video Input		
4. Digital Audio Input		
5. Analog Audio Input		

3 Use the Up and Down [▲]/[▼] buttons to select “4. Digital Audio Input”, and then press [ENTER].



The “Digital Audio Input” menu appears.

1-4. Digital Audio Input		ONKYO
DVD	COAX1	
VCR/DVR	COAX2	
CBL/SAT	COAX3	
GAME/TV	OPT1	
AUX	- - -	
AUX2	FRONT	
TAPE	- - -	
TUNER	- - -	
CD	OPT2	
PHONO	- - -	

MOVE VALUE RETURN EXIT

4

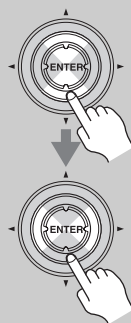

Use the Up and Down [▲]/[▼] buttons to select an input selector, and then use the Left and Right [◀]/[▶] buttons to select: “COAX1”, “COAX2”, “COAX3”, “OPT1”, “OPT2”, or “- - - (analog)”.

- When an HDMI IN is assigned to an input selector in “HDMI Input Setup” on page 56, this input assignment is automatically set to the same HDMI IN. And in addition to the usual inputs (e.g., COAX1, COAX2, etc.), you can also select HDMI inputs. If you change the input assignment from an HDMI IN to one of the other inputs (e.g., COAX1 or COAX2), be sure to set the “Using the DIGITAL INPUT Button” on page 64 to the same input (e.g., COAX1 or COAX2).
- “AUX2” is used only for digital input from the front panel terminals. When HDMI IN is assigned to “AUX2” in the “HDMI Input Setup” on page 56, the same HDMI IN can be selected.

Examples:

If you connect your DVD player to the OPTICAL IN 1 jack, set “DVD” to “OPT1”.

If you want to listen to audio from the component connected to the OPTICAL IN 2 jack when the VCR/DVR input selector is selected, set “VCR/DVR” to “OPT2”.

If you want to listen to audio from the component connected to the COAXIAL IN 1 jack when the CBL/SAT input selector is selected, set “CBL/SAT” to “COAX1”.

For input selectors that you don't want to assign a digital input jack, set to “- - - (analog)”.

5



Press the [SETUP] button. Setup closes.

Notes:

- Only FRONT can be assigned to the AUX 2 input selector.
- This procedure can also be performed on the AV receiver by using its [SETUP] button, arrow buttons, and [ENTER] button.

Analog Audio Input Setup

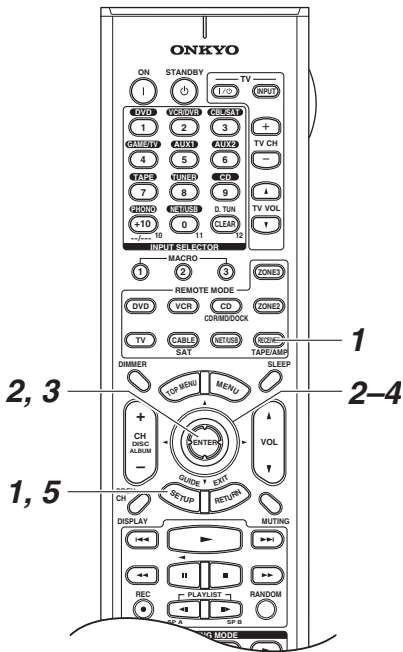

If you connect a component to the AV receiver’s analog multichannel input, you must assign that input to an input selector. For example, if you connect your DVD player to the MULTI CH input, you must assign it to the DVD input selector.

1 Press the [RECEIVER] button, followed by the [SETUP] button. The main menu appears onscreen.

2 Use the Up and Down [▲]/[▼] buttons to select “1. Input/Output Assign”, and then press [ENTER]. The “Input/Output Assign” menu appears.

1. Input/Output Assign	ONKYO
1. Monitor Out	
2. HDMI Input	
3. Component Video Input	
4. Digital Audio Input	
5. Analog Audio Input	

3 Use the Up and Down [▲]/[▼] buttons to select “5. Analog Audio Input”, and then press [ENTER]. The “Analog Audio Input” menu appears.

1-5. Analog Audio Input	ONKYO
Multich	DVD
VALUE RETURN EXIT	

4 Use the Left and Right [◀]/[▶] buttons to select an input selector. You can assign the multichannel input to the following input selectors: “DVD”, “VCR/DVR”, “CBL/SAT”, “GAME/TV”, “AUX1”, “AUX2”, “TAPE”, “CD”, or “PHONO”.

5 Press the [SETUP] button. Setup closes.

Notes:

- To listen to the component connected to the multichannel input, press the [AUDIO SEL] button repeatedly to select Multich (see page 120).
- This procedure can also be performed on the AV receiver by using its [SETUP] button, arrow buttons, and [ENTER] button.

Speaker Settings

If you change these settings, you must run the automatic speaker setup again (see page 64).

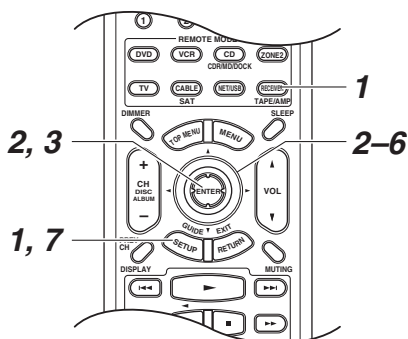

If the impedance of any speaker is 4 ohms or more but less than 6, set the Speaker Impedance to 4 ohms.

To use bi-amping or bridging, you must change the “Speaker Type” setting. For hookup information, see pages 27–30.

Notes:

- When bridging is used, the AV receiver is able to drive up to 5.1 speakers in the main room.
- When bi-amping is used, the AV receiver is able to drive up to 5.1 speakers in the main room.
- Before you change these settings, turn down the volume.

The onscreen menus shown in this manual may be slightly different from what you see on your TV.

1



Press the [RECEIVER] button, followed by the [SETUP] button.
The main menu appears onscreen.
If the main menu doesn't appear, make sure the appropriate external input is selected on your TV.

2



Use the Up and Down [▲]/[▼] buttons to select “2. Speaker Setup”, and then press [ENTER].
The “Speaker Setup” menu appears.

ONKYO	
2. Speaker Setup	
1.	Speaker Settings
2.	Speaker Config
3.	Speaker Distance
4.	Level Calibration
5.	Equalizer Settings
6.	THX Audio Setup

3

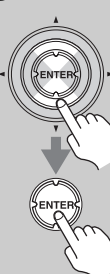

Use the Up and Down [▲]/[▼] buttons to select “1. Speaker Settings”, and then press [ENTER].
The “Speaker Settings” menu appears.

ONKYO	
2-1. Speaker Settings	
Speaker impedance	6ohms
Speaker Type	Normal
Front(Speaker A)	Normal
Front(Speaker B)	Not Use
<small>[▲] MOVE [▶] VALUE [◀] RETURN [EXIT] EXIT</small>	

4



Use the Up and Down [▲]/[▼] buttons to select “Speaker impedance”, and use the Left and Right [◀]/[▶] buttons to select:

4ohms: Select if the impedance of any speaker is 4 ohms or more but less than 6.

6ohms: Select if the impedances of all speakers are between 6 and 16 ohms.

5



Use the Up and Down [▲]/[▼] buttons to select “Front(Speaker A)”, and use the Left and Right [◀]/[▶] buttons to select:

Normal:
Select this if you've connected your front Speakers A normally.

Bi-Amp:
Select this if you've connected your front Speakers A for bi-amped operation.

BTL:
Select this if you've connected your front Speakers A for bridged operation. The BTL indicator will appear on the display.

Note:
“Bi-Amp” and “BTL” cannot be selected if “Front(Speaker B)” is set to “Bi-Amp” or “BTL”.

6



Use the Up and Down [▲]/[▼] buttons to select “Front(Speaker B)”, and use the Left and Right [◀]/[▶] buttons to select:

Not Use:
Select this if you’re not using Speakers B.

Normal:
Select this if you’ve connected your front Speakers B normally.

Bi-Amp:
Select this if you’ve connected your front Speakers B for bi-amped operation.

BTL:
Select this if you’ve connected your front Speakers B for bridged operation. The BTL indicator will appear on the display.

Note:
“Bi-Amp” and “BTL” cannot be selected if “Front(Speaker A)” is set to “Bi-Amp” or “BTL”.

7



Press the [SETUP] button.
Setup closes.

Note:
This procedure can also be performed on the AV receiver by using its [SETUP] button, arrow buttons, and [ENTER] button.

TV Format Setup (not North American models)

For the onscreen setup menus to display properly, you must specify the TV system used in your area.

1



Press the [RECEIVER] button, followed by the [SETUP] button.
The main menu appears onscreen.
If the main menu doesn’t appear, make sure the appropriate external input is selected on your TV.

2



Use the Up and Down [▲]/[▼] buttons to select “6. Miscellaneous”, and then press [ENTER].
The “Miscellaneous” menu appears.

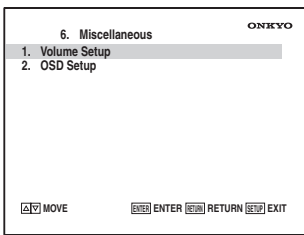

3



Use the Up and Down [▲]/[▼] buttons to select “2. OSD Setup”, and then press [ENTER].
The “OSD Setup” menu appears.

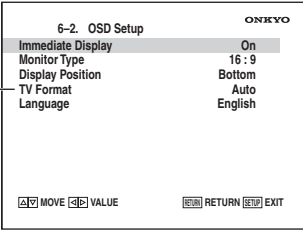

Note:
The “TV Format” (*) setting is not available on the North American models.

4



Use the Up and Down [▲]/[▼] buttons to select “TV Format”, and then use the Left and Right [◀]/[▶] buttons to select:

Auto: Select this to have the AV receiver automatically detect the TV system from the video input signals.

NTSC: Select if the TV system in your area is NTSC.

PAL: Select if the TV system in your area is PAL.

5



Press the [SETUP] button.
Setup closes.

Note:
This procedure can also be performed on the AV receiver by using its [SETUP] button, arrow buttons, and [ENTER] button.

AM Frequency Step Setup (on some models)

For AM tuning to work properly, you must specify the AM frequency step used in your area. Note that when this setting is changed, all radio presets are deleted.

1 Press the [RECEIVER] button, followed by the [SETUP] button. The main menu appears onscreen.



2 Use the Up and Down [▲]/[▼] buttons to select “7. Hardware Setup”, and then press [ENTER]. The “Hardware Setup” menu appears.

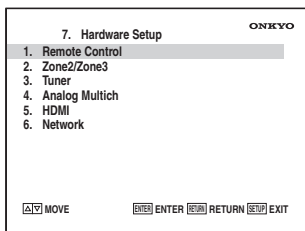

3 Use the Up and Down [▲]/[▼] buttons to select “3. Tuner”, and then press [ENTER]. The “Tuner” menu appears.

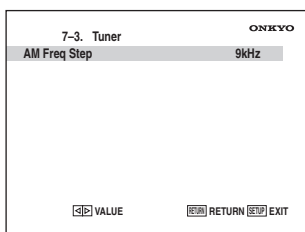
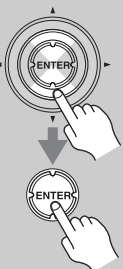

4 Use the Up and Down [▲]/[▼] buttons to select “AM Freq Step”, and then use the Left and Right [◀]/[▶] buttons to select:

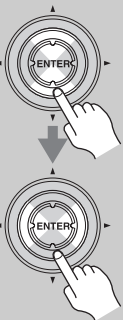

10kHz: Select if 10 kHz steps are used in your area.

9kHz: Select if 9 kHz steps are used in your area.

5 Press the [SETUP] button. Setup closes.



Note:

This procedure can also be performed on the AV receiver by using its [SETUP] button, arrow buttons, and [ENTER] button.

Changing the Input Display

If you connect an **RI**-capable Onkyo MiniDisc recorder, CD recorder, or RI Dock to the TAPE IN/OUT jacks, or connect an RI Dock to the AUX 1 jacks, for **RI** to work properly, you must change this setting.

This setting can only be changed on the AV receiver.

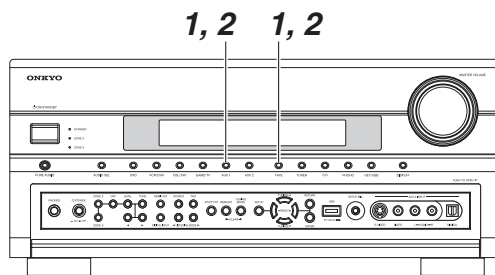

1 Press the [TAPE] or [AUX 1] input selector button so that “TAPE” or “AUX1” appears on the display.



2 Press and hold down the [TAPE] or [AUX 1] input selector button (about 3 seconds) to change the setting.

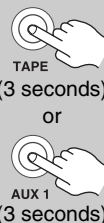

Repeat this step to select MD, CDR, or DOCK.

For the TAPE input selector, the setting changes in this order:

TAPE → MD → CDR
 ↑ DOCK ↓

For the AUX 1 input selector, the setting changes in this order: AUX1 ↔ DOCK

Note:

DOCK can be selected for the TAPE input selector or AUX 1 input selector, but not both at the same time.

Using the DIGITAL INPUT Button

Digital inputs can also be assigned to input selectors by using the [DIGITAL INPUT] button on the AV receiver.

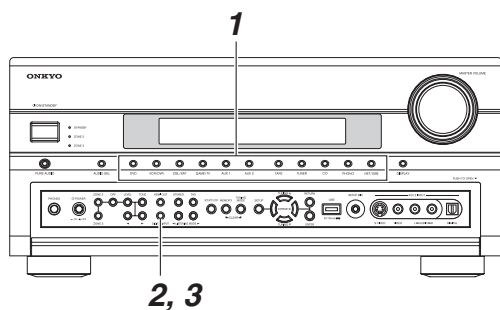

<p>1</p>	<p>Press the input selector button for the input selector that you want to assign.</p>
<p>2</p> <p>DIGITAL INPUT</p>	<p>Press the [DIGITAL INPUT] button. The current assignment is displayed.</p> <pre>DIGITAL INPUT #COAX1</pre>
<p>3</p> <p>DIGITAL INPUT</p>	<p>Press the [DIGITAL INPUT] button repeatedly to select an option. Available options are the same as for the Digital Input menu. See step 4 on page 59.</p>

Automatic Speaker Setup (Audyssey MultEQ® XT)

With the supplied calibrated microphone, Audyssey MultEQ XT automatically determines the number of speakers connected, their size for purposes of bass management, optimum crossover frequencies to the subwoofer (if present), and distances from the primary listening position.

Audyssey MultEQ XT then removes the distortion caused by room acoustics by capturing room acoustical problems over the listening area in both the frequency and time domain. The result is clear, well-balanced sound for everyone. Enabling Audyssey MultEQ XT allows you to also use Audyssey Dynamic EQ™, which maintains the proper octave-to-octave balance at any volume level.

Before using this function, connect and position all of your speakers.

If Audyssey Dynamic EQ is set to “Enable”, Audyssey Dynamic Volume™ becomes available.

About Audyssey Dynamic Volume

Audyssey Dynamic Volume solves the problem of large variations in volume level between television programs, commercials, and between the soft and loud passages of movies. Dynamic Volume looks at the preferred volume setting by the user and then monitors how the volume of program material is being perceived by listeners in real time to decide whether an adjustment is needed. Whenever necessary, Dynamic Volume makes the necessary rapid or gradual adjustments to maintain the desired playback volume level while optimizing the dynamic range. Audyssey Dynamic EQ is integrated into Dynamic Volume so that as the playback volume is adjusted automatically, the perceived bass response, tonal balance, surround impression, and dialog clarity remain the same whether watching movies, flipping between television channels, or changing from stereo to surround sound content.

About Dynamic EQ

Audyssey Dynamic EQ solves the problem of deteriorating sound quality as volume is decreased by taking into account human perception and room acoustics. Dynamic EQ selects the correct frequency response and surround levels moment-by-moment at any user-selected volume setting. The result is bass response, tonal balance, and surround impression that remain constant despite changes in volume. Dynamic EQ combines information from incoming source levels with actual output sound levels in the room, a prerequisite for delivering a loudness correction solution. Audyssey Dynamic EQ works in tandem with Audyssey MultEQ to provide well-balanced sound for every listener at any volume level.

Measurement Positions

To create a listening environment in your home theater that all listeners will enjoy, Audyssey MultEQ® takes measurements at up to eight positions within the listening area.

■ 1st measurement position

This is the center position of your listening area, or the listening position if there's only one listener.

■ 2nd–8th measurement positions

These are the other listening positions (i.e., the places where the other listeners will sit). You can measure up to eight positions.

The following examples show some typical home theater seating arrangements. Choose the one that best matches yours, and position the microphone accordingly when prompted.

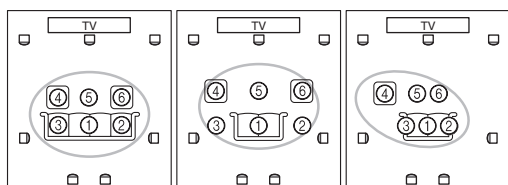
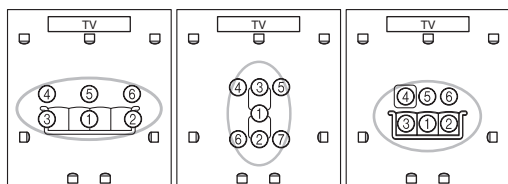
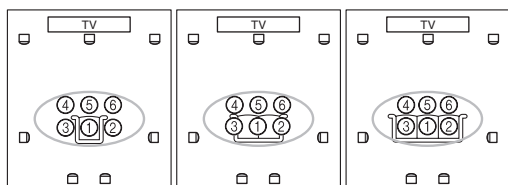

○ : listening area ①—⑦ : listening position

Using Audyssey MultEQ® XT

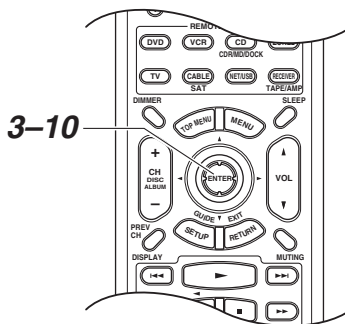
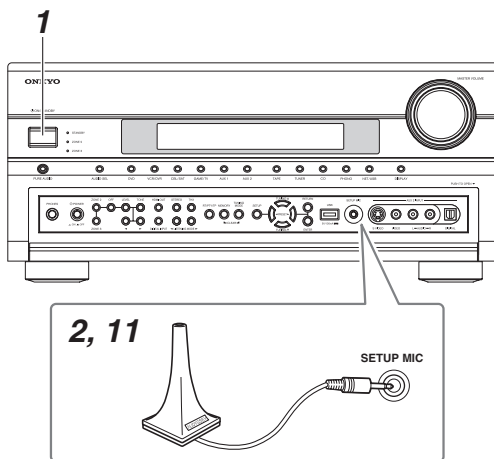

Notes:

- If any of your speakers is 4 ohms, change the "Speaker impedance" setting before running the automatic speaker setup (see page 61).
- If the AV receiver is muted, it will be unmuted automatically when the automatic speaker setup starts.
- Automatic speaker setup can only be used with Speakers A.
- Automatic speaker setup cannot be performed while a pair of headphones is connected, or Speakers B is selected.
- It takes about 15 minutes to complete the automatic speaker setup for three positions. Total measurement time varies depending on the number of positions and speakers.
- Do not disconnect the speaker setup microphone during the automatic speaker setup, unless you want to cancel the setup.
- Do not connect or disconnect any speakers during the automatic speaker setup.

The onscreen menus shown in this manual may be slightly different from what you see on your TV.

1 Turn on the AV receiver and the connected TV.
On the TV, select the input to which the AV receiver is connected.

2 Place the speaker setup microphone at measurement point ① (page 64), and connect it to the SETUP MIC jack.

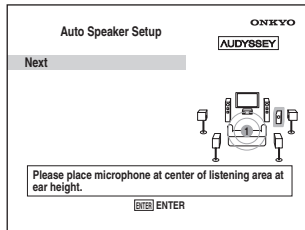

Notes:

- Before starting Audyssey MultEQ[®] XT Automatic Speaker Setup, arrange the room and connect the speakers as you would for enjoying movies. Changes to the room after auto setup requires you run the auto setup again, as room EQ characteristics may have changed.
- When starting the automatic speaker setup, do not stand between the speakers and microphone, and avoid obstacles blocking the path between speakers and microphone. This will produce inaccurate results.
- Position the microphone at ear height of a seated listener with the microphone tip pointed directly at the ceiling using a tripod. Do not hold the microphone in your hand during measurements as this will produce inaccurate results.
- Make the room as quiet as possible. Background noise can disrupt the room measurements. Close windows, silence cell phones, televisions, radios, air conditioners, fluorescent lights, home appliances, light dimmers, or other devices.
- Cell phones should be turned off or placed away from all audio electronics during the measurement process as Radio Frequency Interference (RFI) may cause measurement disruptions (even if the cell phone is not in use).

3 Press [ENTER].
The automatic speaker setup starts.

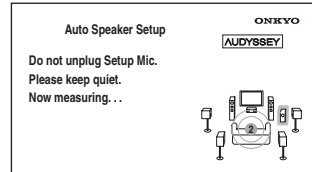

Test tones are played through each speaker as Audyssey MultEQ[®] XT Automatic Speaker Setup runs. This process takes a few minutes. Please refrain from talking during measurements and do not stand between speakers and the microphone.

4 The speaker detect results appear.

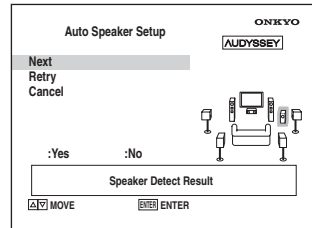

“Yes” means that the speaker was detected. “No” means that no speaker was detected.

If you agree with the results, use the Up and Down [▲]/[▼] buttons to select “Next”, and then press [ENTER].

The options are:

Next: Proceed to the next step.

Retry: Return to step 2 and try again.

Cancel: Cancel the automatic speaker setup.

5 The following screen appears.

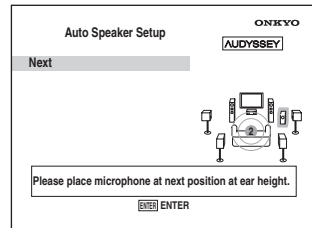

Place the setup microphone at the next position (see page 65), and then press [ENTER].

Audyssey MultEQ[®] XT performs more measurements. This takes a few minutes.

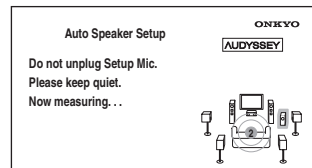

6

When prompted, place the setup microphone at the next position, and repeat step 5.

7

After the 3rd or 7th measurement, the following screen appears.

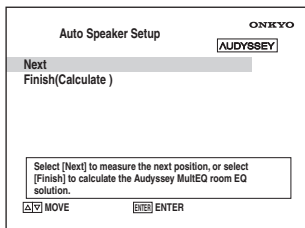
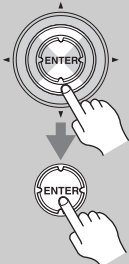

Use the Up and Down [▲]/[▼] buttons to select an option, and then press [ENTER].

Next:

Select “Next” to begin measuring the next measurement position. After the 8th measurement has been taken, the procedure automatically proceeds to step 8.

Finish(Calculate):

Select this if you don’t want to measure any more listening positions and are ready to calculate the results, then go to step 8.

8

When the measurements are complete, the following screen appears.

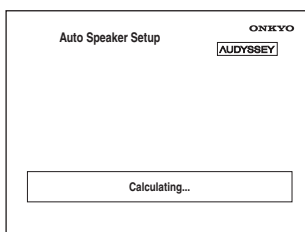

9

When the calculations are complete, the following screen appears.

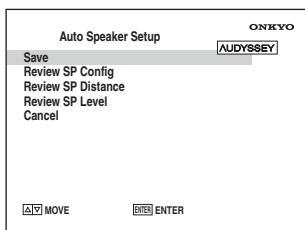
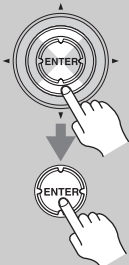

Use the Up and Down [▲]/[▼] buttons to select an option, and then press [ENTER].

Save:

Save the calculated settings and exit the automatic speaker setup.

Review SP Config:

Review the speaker configuration settings (see “Reviewing the Results” on page 69).

Review SP Distance:

Review the speaker distance settings (see “Reviewing the Results” on page 69).

Review SP Level:

Review the speaker level settings (see “Reviewing the Results” on page 69).

Cancel:

Cancel the automatic speaker setup.

10

If you selected “Save”, the results are saved, and the following screen appears.

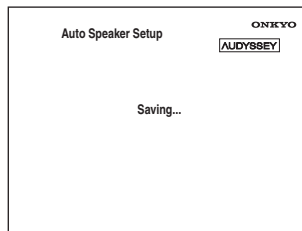

11

Disconnect the setup MIC.

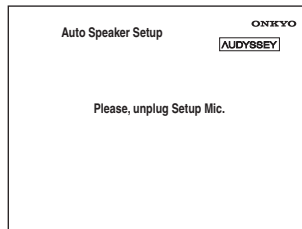

Notes:

- When the automatic speaker setup is complete, the “Equalizer Settings” (page 102) will be set to Audyssey.
- You can cancel the automatic speaker setup at any point in the procedure simply by disconnecting the setup microphone.

Error Messages

While the automatic speaker setup is in progress, one of the following error messages may appear:

❑ Ambient noise is too high

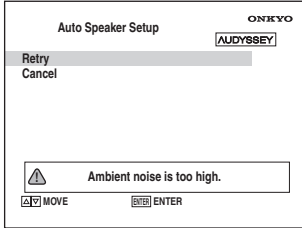

This message appears if the background noise is too loud and the measurements cannot be performed properly.

Remove the source of the noise and try again.

Retry: Return to the measured point immediately before and start set up again.

Cancel: Cancel the automatic speaker setup.

❑ Speaker Detect Error

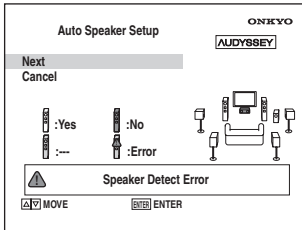

This message appears if a speaker is not detected. “Yes” means that a speaker was detected. “No” means that no speaker was detected. Check your speaker connections and retry, or cancel the automatic speaker setup.

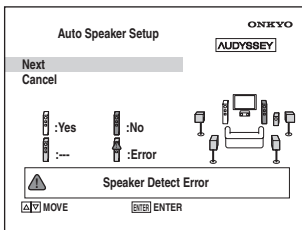

The front right speaker has not been detected.

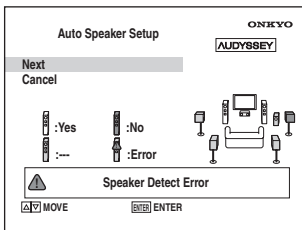

The surround right speaker has not been detected.

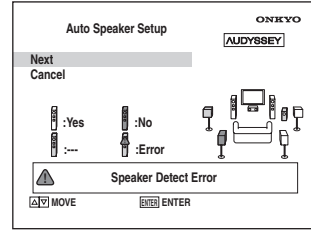

The surround back left speaker has not been detected.

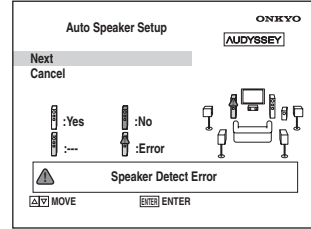

There is a problem with the front left speaker. If the warning triangle (▲) appears for the subwoofer, it may be that the output from the subwoofer is too loud.

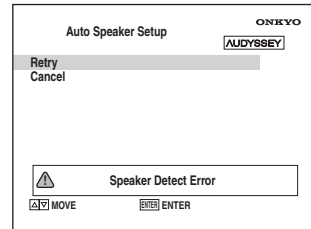

The number of speakers detected on the second or third measurement was different to the number detected on the first measurement.

Make sure speakers that cannot be detected are connected properly.

Retry: Return to step 2 and try again.

Cancel: Cancel the automatic speaker setup.

❑ Writing Error!

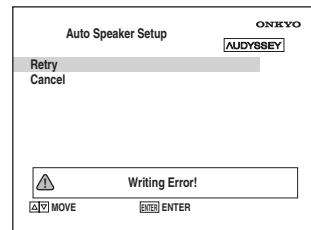

This message appears if saving fails.

Try saving again. If this message appears after 2 or 3 attempts, the AV receiver is probably malfunctioning. Contact your Onkyo dealer.

Retry: Return to step 2 and try again.

Cancel: Cancel the automatic speaker setup.

Reviewing the Results

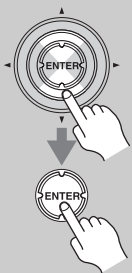

Use the Up and Down [▲]/[▼] buttons to select the settings that you want to review, and then press [ENTER].

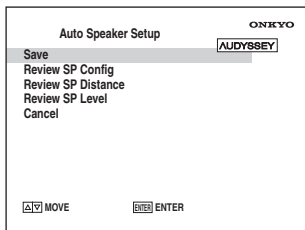

The options are:

Review SP Config

Review the speaker configuration settings.

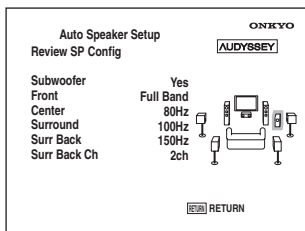

Review SP Distance

Review the speaker distance settings.

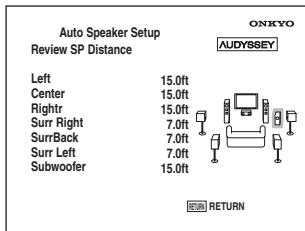

Review SP Level

Review the speaker level settings.

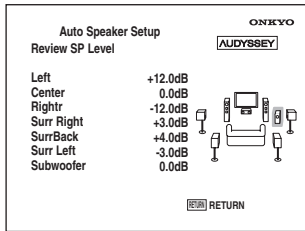

Press [RETURN] to return to the previous screen.

Changing the Speaker Settings Manually

In rare situations, proper measurements taken may not be obtainable by the automatic speaker setup. For example, there may be too much noise in the room. If running the speaker setup a second time is still unsuccessful you will have to set the speaker settings manually. (see pages 95–102).

Notes:

- For THX-certified speakers, the 80 Hz (THX) crossover frequency is recommended. If you use the automatic speaker setup, you'll need to manually select 80 Hz (THX) for each THX-certified speaker (see page 95).
- Because of the complexities of low-frequency sounds and the way they interact with a room, THX recommends setting the subwoofer level and distance manually.

Using a Powered Subwoofer

If you're using a powered subwoofer and it outputs very low-frequency sound at a low volume level, it may not be detected by the automatic speaker setup.

If the "Subwoofer" appears on the "Review SP Config" screen as "No", increase the subwoofer's volume to the half-way point, set it to its highest crossover frequency, and then try running the automatic speaker setup again. Note that if the volume is set too high and the sound distorts, detection issues may occur, so use an appropriate volume level. If the subwoofer has a low-pass filter switch, set it to Off or Direct. Refer to your subwoofer's instruction manual for details.

Basic Operations

Selecting the Input Source

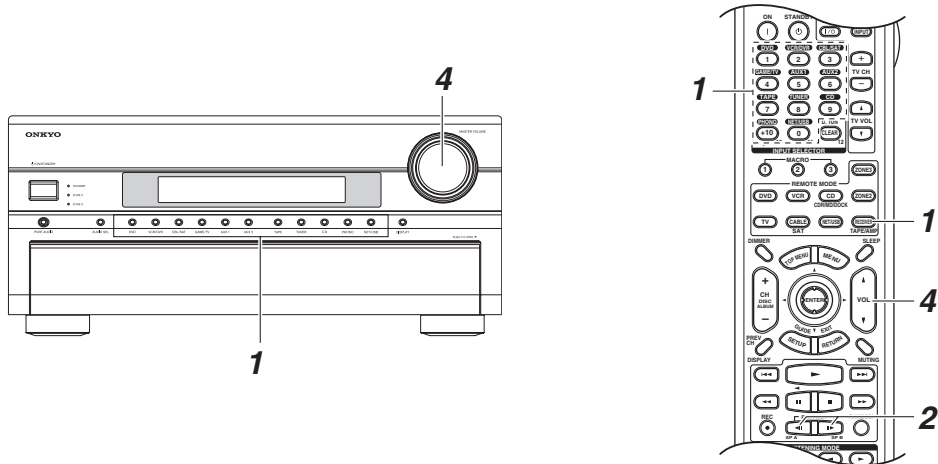

- 1**

Use the AV receiver's input selector buttons to select an input source.

To select an input source with the remote controller, press its [RECEIVER] REMOTE MODE button, and then use its INPUT SELECTOR buttons.
- 2**

To switch between Speakers A and Speakers B, use the remote controller's [SP A] and [SP B] buttons (TX-NR906 only).
- 3**

Start playback on the source component.

When you select DVD or another video component, on your TV, you'll need to select the video input that's connected to the AV receiver's COMPONENT VIDEO MONITOR OUT, HDMI OUT MAIN, HDMI OUT SUB, or MONITOR OUT. On some DVD players, you may need to turn on the digital audio output.
- 4**

To adjust the volume, use the MASTER VOLUME control, or the remote controller's VOL [▲]/[▼] button.

The volume can be set to $-\infty$ dB, -81.5 dB through $+18.0$ dB (relative display). The AV receiver is designed for home theater enjoyment. It has a wide volume range, allowing precise adjustment. The volume level can also be displayed as an absolute value. See "Volume Setup" on page 115.
- 5**

Select a listening mode and enjoy!

See "Using the Listening Modes" on page 81.

Basic Operations—Continued

This section explains functions that can be used with any input source.

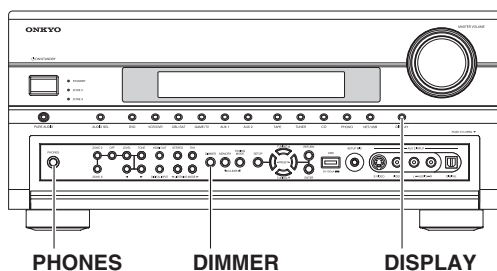
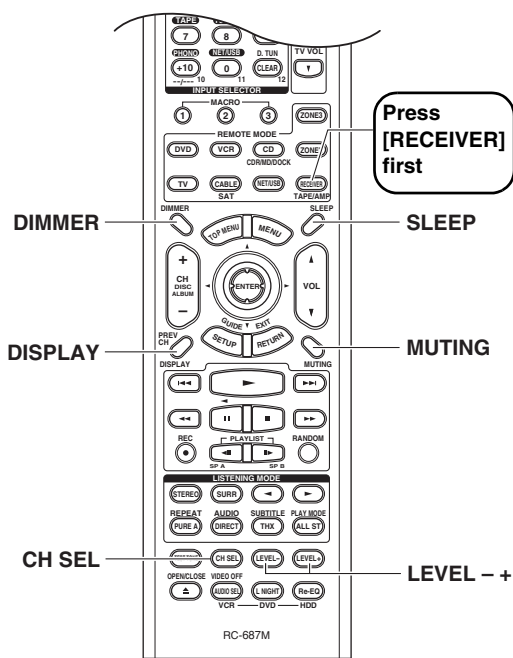

Setting the Display Brightness

You can adjust the brightness of the display.

Remote controller
DIMMER



Press the remote controller's [DIMMER] button repeatedly to select:

- Normal + VOLUME light on.
- Normal + VOLUME light off.
- Dim + VOLUME light off.
- Dimmer + VOLUME light off.

AV receiver
DIMMER



You can also use the AV receiver's [DIMMER] button (not European models).

Adjusting Speaker Levels

You can adjust the volume of each speaker while listening to an input source. These temporary adjustments are cancelled when the AV receiver is set to Standby.



Use the remote controller's [CH SEL] button to select each speaker, and use the [LEVEL-] and [LEVEL+] buttons to adjust the volume.

You can adjust the volume of each speaker from -12 dB to +12 dB (-15 dB to +12 dB for the subwoofer).



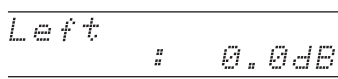

Notes:

- You cannot use this function while the AV receiver is muted.
- Speakers that are set to “No” or “None” in the “Speaker Config” cannot be adjusted (see page 95).

■ Headphones

While a pair of headphones is connected, you can use the [CH SEL], [LEVEL-], and [LEVEL+] buttons to adjust the volume of each headphone speaker (left and right), from -12 dB to +12 dB each.

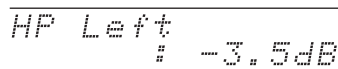

These settings are stored when the AV receiver is set to Standby.

Muting the AV Receiver

You can temporarily mute the output of the AV receiver.



Press the remote controller's [MUTING] button.

The output is muted and the MUTING indicator flashes on the display, as shown.



To unmute the AV receiver, press the [MUTING] button again, or adjust the volume.

The Mute function is cancelled when the AV receiver is set to Standby.

Tip:

- You can specify how much the output is muted with the “Muting Level” setting (see page 115).

Using the Sleep Timer

With the sleep timer, you can set the AV receiver to turn off automatically after a specified period.



Press the [RECEIVER] button, and then press the [SLEEP] button repeatedly to select the required sleep time.

The sleep time can be set from 90 to 10 minutes in 10 minute steps.

The SLEEP indicator appears on the display when the sleep timer has been set. The specified sleep time appears on the display for about five seconds, then the previous display reappears.

If you need to cancel the sleep timer, press the [SLEEP] button repeatedly until the SLEEP indicator disappears.

To check the time remaining until the AV receiver sleeps, press the [SLEEP] button. Note that if you press the [SLEEP] button while the sleep time is being displayed, you'll shorten the sleep time by 10 minutes.

Using Headphones

For private listening, you can connect a pair of stereo headphones (1/4-inch phone plug) to the AV receiver's PHONES jack.

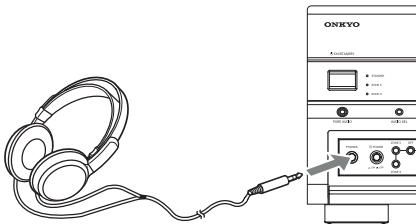

Notes:

- Always turn down the volume before connecting your headphones.
- While the headphones plug is inserted in the PHONES jack, the speakers are turned off and the Headphone indicator lights up. (The Powered Zone 2 speakers are not turned off.)
- When you connect a pair of headphones, the listening mode is set to Stereo, unless it's already set to Stereo, Mono, Direct, or Pure Audio.
- Only the Stereo, Direct, Pure Audio, and Mono listening modes can be used with headphones (the listening modes available also depend on the currently selected input source).
- When the multichannel input is used, only the front left and right audio can be heard in the headphones.

Adjusting the Bass & Treble

You can adjust the bass and treble for the front speakers, except when the Direct, Pure Audio or THX listening mode is selected.



1 Press the AV receiver's [TONE] button repeatedly to select Bass or Treble for Front, Center, Surround, SurrBack, or Subwoofer.

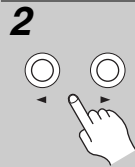

2 Use the Up [▶] and Down [◀] buttons to adjust.

■ Bass

You can boost or cut low-frequency sounds output by the front speakers from -10 dB to +10 dB in 1 dB steps.

■ Treble

You can boost or cut high-frequency sounds output by the front speakers from -10 dB to +10 dB in 1 dB steps.

Notes:

- This setting is not available when the multichannel Analog input is selected.
- The tone can be adjusted for Speakers A or Speakers B. The same values are used for both.
- The tone control settings do not apply to the Direct, Pure Audio, or THX listening modes.

Displaying Source Information

You can display various information about the current input source as follows.

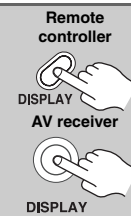

Press the [DISPLAY] button repeatedly to cycle through the available information.

The following information can typically be displayed:



* If the input signal is analog, no format information is displayed. If the input signal is PCM, the sampling frequency is displayed. If the input signal is digital but not PCM, the signal format and the number of channels is displayed. For some digital input signals, including multichannel PCM, the signal format, number of channels, and sampling frequency is displayed. Information is displayed for about three seconds, then the previously displayed information reappears.

Listening to the Radio

Listening to AM/FM Stations

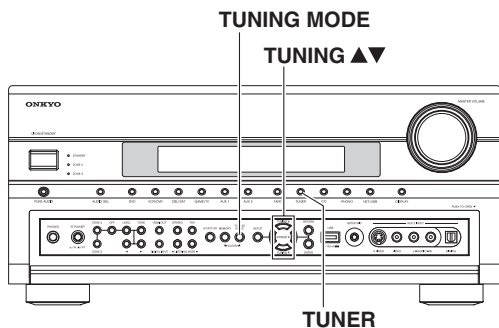

With the built-in tuner, you can enjoy AM and FM radio stations and store your favorite stations as presets for easy selection.



Use the [TUNER] input selector button to select AM or FM.

In this example, FM has been selected.

Band	Frequency
FM	87.5 MHz

(Actual display depends on country.)

Tuning into AM/FM Radio Stations

Auto Tuning Mode

1



Press the [TUNING MODE] button so that the AUTO indicator appears on the display.

2

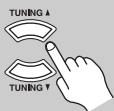

Press the TUNING Up or Down [▲]/[▼] button.

Searching stops when a station is found.

When tuned into a station, the TUNED indicator appears. When tuned into a stereo FM station, the FM STEREO indicator also appears. (The FM STEREO indicator will not appear on models that have HD Radio.)

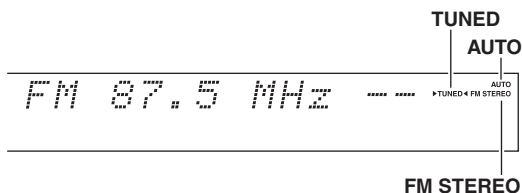

Manual Tuning Mode

1



Press the [TUNING MODE] button so that the AUTO indicator disappears from the display.

2

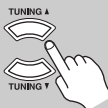

Press and hold the TUNING Up or Down [▲]/[▼] button.

The frequency stops changing when you release the button.

Press the button repeatedly to change the frequency one step at a time.

The North American model changes FM frequency in 0.2 MHz steps, 10 kHz steps for AM. For other models it's 0.05 MHz steps for FM and 9 kHz steps for AM. In Manual Tuning mode, FM stations will be in mono.

Tuning into Weak FM Stereo Stations

If the signal from a stereo FM station is weak, it may be impossible to get good reception. In this case, switch to Manual Tuning mode and listen to the station in mono.

Listening to the Radio—Continued

■ Tuning into Stations by Frequency

You can tune into AM and FM stations directly by entering the appropriate frequency.

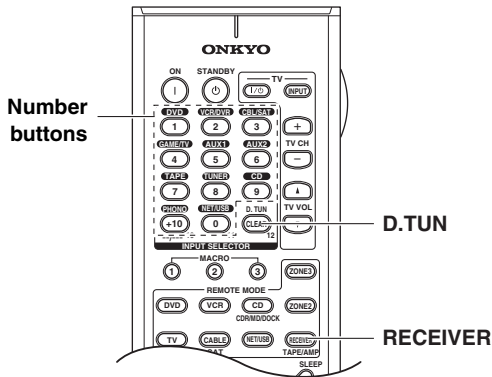

1

Press the [RECEIVER] button, followed by the [D.TUN] button.
The [RECEIVER] button flashes.

(Actual display depends on country.)

2

Within 8 seconds, use the number buttons to enter the frequency of the radio station.
For example, to tune to 87.5 (FM), press 8, 7, 5.

Note:
While the [RECEIVER] button is flashing, you cannot select another input source with the remote controller.

Displaying AM/FM Radio Information

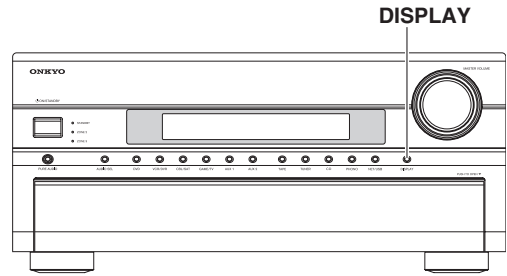

Press the [DISPLAY] button to display the available information.

Band	Frequency	Preset #
FM	87.5 MHz	1
Stereo		

Listening mode



Note:

When you select a preset with a custom name (see page 110), its name is displayed instead of the band and frequency.

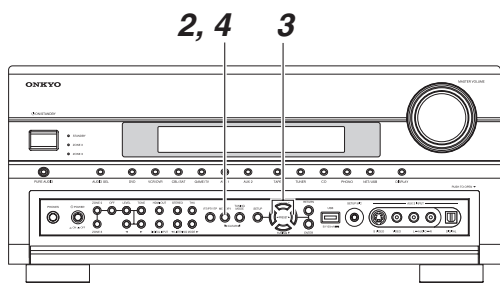
Presetting AM/FM Stations



You can store a combination of up to 40 of your favorite AM and FM radio stations.



- | | |
|---|---|
| 1 | Tune into the AM or FM station you want to store as a preset. |
| 2
MEMORY
 | Press the [MEMORY] button.
The preset number flashes. |
| 3
 | While the preset number is flashing (about 8 seconds), use the PRESET [◀]/[▶] buttons to select a preset from 1 through 40. |
| 4
MEMORY
 | Press the [MEMORY] button again to store the station.
The station is stored and the preset number stops flashing.
Repeat this procedure for all of your favorite stations. |

Note:

You can name your radio presets for easy identification (see page 110).

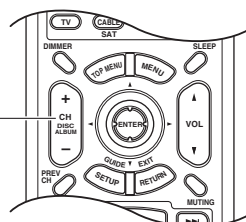
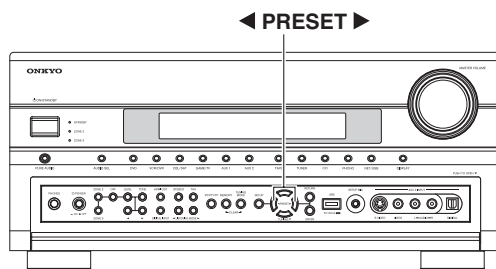
Selecting Presets



- | | |
|--|---|
|  | To select a preset, use the PRESET [◀]/[▶] buttons or the remote controller's CH [+/-] button. |
|  | |

Deleting Presets

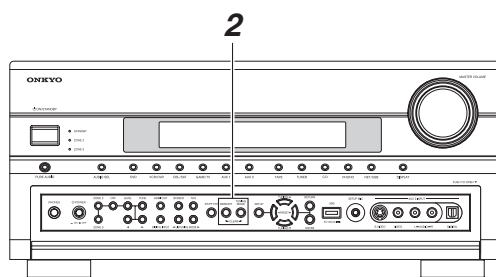

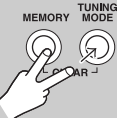
- | | |
|---|---|
| 1 | Select the preset that you want to delete.
See the previous section. |
| 2
MEMORY TUNING MODE
 | While holding down the [MEMORY] button, press the [TUNING MODE] button.
The preset is deleted and its number disappears from the display. |

**Listening to HD Radio™ Stations
(North American model only)**

HD Radio technology brings digital radio to conventional analog AM and FM radio stations, with improved sound quality, better reception, and new data services. HD Radio technology provides CD-quality sound for FM stations and FM-quality sound for AM stations. In addition, FM HD Radio stations can transmit multiple programs on the same frequency by using multicast channels. Text data display includes station name, song title, artist name, and so on.

For more information about HD Radio technology, visit:
www.ibiquity.com
www.hdradio.com

About HD Radio Stations

HD Radio stations broadcast on the same AM and FM frequencies they've always used, and you can receive them by tuning into your favorite station as normal (see page 73). You can store them as presets just like AM and FM stations (see page 75).

If the current AM or FM station supports HD Radio technology, the HD indicator lights up.

While a digital HD Radio transmission is being received, the DIGITAL indicator lights up. While an analog HD Radio transmission is being received, the ANALOG indicator lights up.

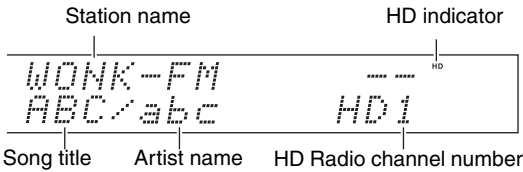

- If the current AM or FM station supports HD Radio technology, the station's name will be displayed instead of the band and frequency.
- When music data is received, song title and artist name information is displayed.
- If the current HD Radio station supports multicast channels, the name of the currently selected multicast channel will be displayed.

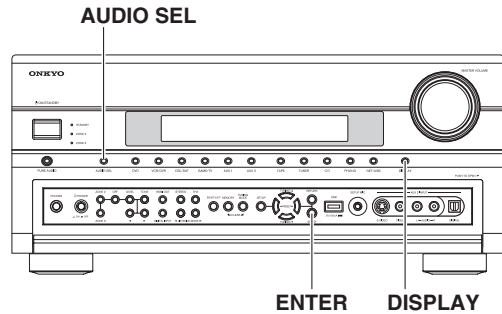
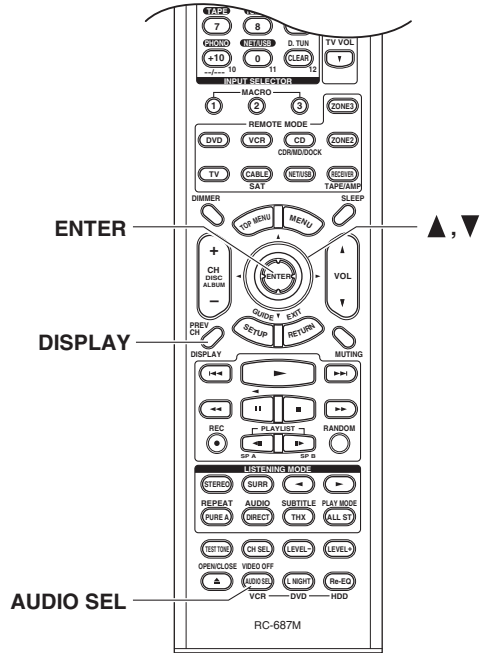

Using RDS

RDS only works in areas where RDS broadcasts are available. When tuned to an RDS station, the RDS indicator appears.

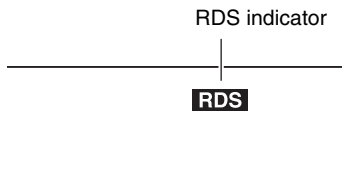

■ What is RDS?

RDS stands for *Radio Data System* and is a method of transmitting data in FM radio signals. It was developed by the European Broadcasting Union (EBU) and is available in most European countries. RDS is approved by the National Radio Systems Committee (NRSC) and is available in North America.

Many FM stations use it these days. In addition to displaying text information, RDS can also help you find radio stations by type (e.g., news, sport, rock, etc.).

The AV receiver supports four types of RDS information:

PS (Program Service)

When tuned to an RDS station that's broadcasting PS information, the station's name will be displayed. Pressing the [DISPLAY] button will display the frequency for 3 seconds.

RT (Radio Text)

When tuned to an RDS station that's broadcasting text information, the text will be shown on the display (see page 78).

PTY (Program Type)

This allows you to search RDS radio stations by type (see page 78).

TP (Traffic Program)

This allows you to search for RDS radio stations that broadcast traffic information (see page 78).

Notes:

- In some cases, the characters displayed on the AV receiver may not be identical to those broadcast by the radio station. Also, unexpected characters may be displayed when unsupported characters are received. This is not a malfunction.
- If the signal from an RDS station is weak, RDS data may be displayed intermittently or not at all.

RDS Program Types (PTY)

Type	Display
None	NONE
News reports	NEWS
Current affairs	AFFAIRS
Information	INFO
Sport	SPORT
Education	EDUCATE
Drama	DRAMA
Culture	CULTURE
Science and technology	SCIENCE
Varied	VARIED
Pop music	POP M
Rock music	ROCK M
Middle of the road music	EASY M
Light classics	LIGHT M
Serious classics	CLASSICS
Other music	OTHER M
Weather	WEATHER
Finance	FINANCE
Children's programmes	CHILDREN
Social affairs	SOCIAL
Religion	RELIGION
Phone in	PHONE IN
Travel	TRAVEL
Leisure	LEISURE
Jazz music	JAZZ
Country music	COUNTRY
National music	NATION M
Oldies music	OLDIES
Folk music	FOLK M
Documentary	DOCUMENT
Alarm test	TEST
Alarm	ALARM

Listening to the Radio—Continued

Displaying Radio Text (RT)

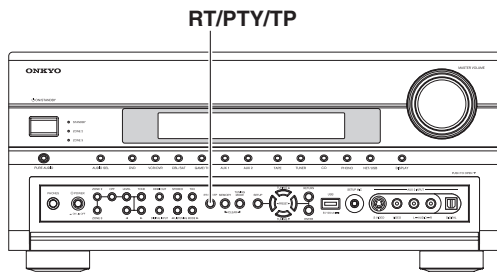

When tuned to an RDS station that's broadcasting text information, the text can be displayed.

RT/PTY/TP



Press the [RT/PTY/TP] button once.

The RT information scrolls across the display.

Notes:

- The message "Waiting" may appear while the AV receiver waits for the RT information.
- If the message "No Text Data" appears on the display, no RT information is available.

Finding Stations by Type (PTY)

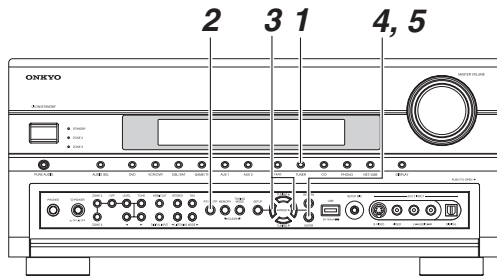

You can search for radio stations by type.

1



TUNER

Use the [TUNER] input selector button to select FM.

2



RT/PTY/TP

Press the [RT/PTY/TP] button twice.

The current program type appears on the display.

3



PRESET

Use the PRESET [◀]/[▶] buttons to select the type of program you want.

See the table on page 77.

4



ENTER

To start the search, press [ENTER].

The AV receiver searches until it finds a station of the type you specified, at which point it stops briefly before continuing with the search.

5



ENTER

When a station you want to listen to is found, press [ENTER].

If no stations are found, the message "Not Found" appears.

Listening to Traffic News (TP)

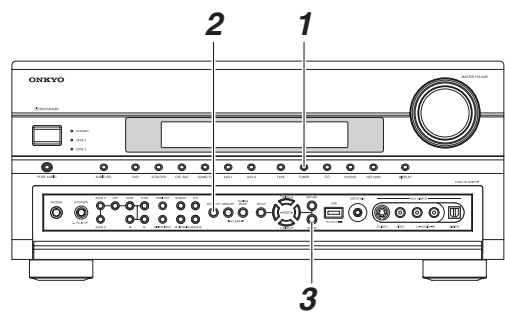

You can search for stations that broadcast traffic news.

1



TUNER

Use the [TUNER] input selector button to select FM.

2



RT/PTY/TP

Press the [RT/PTY/TP] button three times.

If the current radio station is broadcasting TP (Traffic Program), "[TP]" will appear on the display and traffic news will be heard as and when it's broadcast. If "TP" without square brackets appears, this means that the station is not broadcasting TP.

3



ENTER

To locate a station that is broadcasting TP, press [ENTER].

The AV receiver searches until it finds a station that's broadcasting TP. If no stations are found, the message "Not Found" appears.

Listening to the Radio—Continued

Selecting Multicast Channels

FM HD Radio stations can transmit multiple programs on the same frequency by using what are called *multicast channels*. If the current HD Radio station is broadcasting multicast channels, the SPS (secondary program services) indicator lights up.

1



Press [ENTER].

The SPS indicator flashes.

2



Use the Up and Down Arrow [▲]/[▼] buttons to select a multicast channel.

If you select a multicast channel that is not currently broadcasting, a plus [+] symbol will appear, indicating that the channel has been reserved. When broadcasting commences, that channel will be selected automatically.

```
WONK-FM      --
Reserve      +HD4
```

Reserved channel indication
HD Radio channel number

Within 5 seconds, press [ENTER] to set the multicast channel.

Note:

Multicast channels are not available on AM.

Note:

Multicast channels 2 through 8 only carry a digital signal, so to select an audio format, you must select multicast channel #1 first.

Displaying HD Radio Information

Press the [DISPLAY] button repeatedly to cycle through the available information.

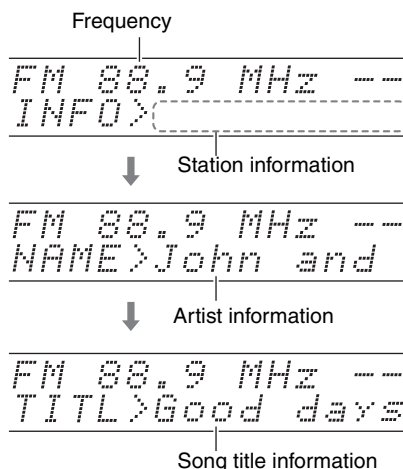

Selecting the Audio Format (Blend Mode)

HD Radio stations transmit both analog and digital versions of their programs and you can choose which one you want to listen to.

Remote controller



AV receiver



AUDIO SEL

Use the [AUDIO SEL] button to select “Auto” or “Analog”.

```
Blend Mode --
# Analog
```



```
Auto
```

Auto: Select to use the digital signal.

Analog: Select to use the analog signal.

Recording

This section explains how to record the input source and how to record audio and video from separate sources.

Notes:

- The surround sound and DSP listening modes cannot be recorded.
- Copy-protected DVDs cannot be recorded.
- Sources connected to the analog multichannel input cannot be recorded.
- Various restrictions apply to digital recording. Refer to the manuals supplied with your digital recording equipment for more details.
- Digital input signals are output by only the digital outputs, and analog input signals are output by only the analog outputs. There is no internal conversion from digital to analog or vice versa.
- DTS signals will be recorded as noise, so don't attempt analog recording of DTS CDs or LDs.
- While the Pure Audio listening mode is selected, the VCR/DVR OUT V and S jacks don't output video signals, so select another mode when recording.

Recording the Input Source

Audio sources can be recorded to a recorder (e.g., cassette deck, CDR, MD) connected to the TAPE OUT or DIGITAL OPTICAL OUT jacks. Video sources can be recorded to a video recorder (e.g., VCR, DVR) connected to the VCR/DVR OUT jacks. See pages 33 to 50 for hookup information.

1

Remote controller

Use the input selector buttons to select the source that you want to record.

See “Which Connections Should I Use?” on page 34 to see which signals can be output and recorded.

You can watch the source while recording it. The AV receiver's MASTER VOLUME control has no effect on recording.

2

On your recorder, start recording.

3

On the source component, start playback.

Recording from Different AV Sources

You can overdub audio onto your video recordings by simultaneously recording audio and video from two separate sources. This is possible because only the audio source is switched when an audio-only input source, such as TAPE, TUNER, or CD, is selected, the video source remains the same.

In the following example, audio from the CD player connected to the CD IN and video from the camcorder connected to the AUX 2 INPUT VIDEO jack are recorded by the VCR connected to the VCR/DVR OUT jacks.

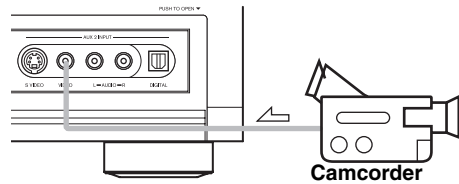

↖ : video signal
↙ : audio signal

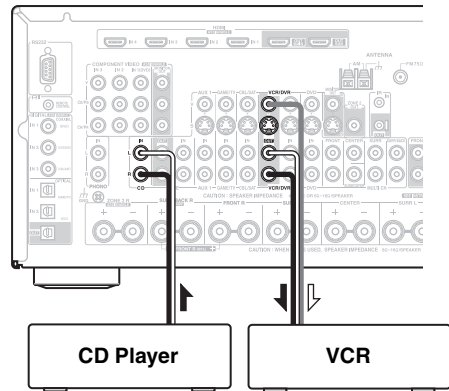

- 1** Prepare the camcorder and CD player for playback.
- 2** Prepare the VCR for recording.
- 3** Press the [AUX 2] input selector button.
- 4** Press the [CD] input selector button.
This selects the CD player as the audio source but leaves the camcorder as the video source.
- 5** Start recording on the VCR, then start playback on the camcorder and CD player.
Video from the camcorder and audio from the CD player are recorded by the VCR.

Note:

If you select a different input source during recording, that input source will be recorded instead.

Using the Listening Modes

Selecting the Listening Modes

For a description of each listening mode, see “About the Listening Modes” on page 88.

- The Dolby Digital and DTS listening modes can only be selected if your DVD player is connected to the AV receiver with a digital audio connection (coaxial, optical, or HDMI).
- The listening modes you can select depends on the format of the input signal. To check the format, see “Displaying Source Information” on page 72.
- While a pair of headphones is connected, you can only select the Pure Audio, Mono, Direct, or Stereo listening mode.

Selecting on the AV Receiver

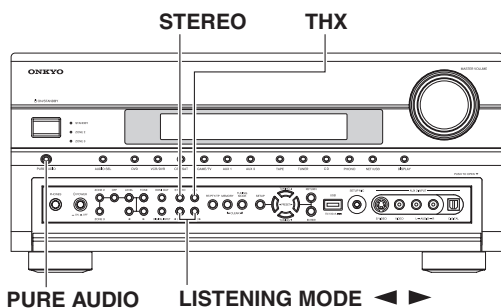

- **[PURE AUDIO] button**
This button selects the Pure Audio listening mode. When this mode is selected, the AV receiver’s display is turned off and only video signals input through HDMI IN can be output. Pressing this button again will select the previous listening mode.
- **[STEREO] button**
This button selects the Stereo listening mode.
- **[THX] button**
This button selects the THX listening modes.
- **LISTENING MODE [◀]/[▶] buttons**
Pressing these buttons repeatedly cycles through all of the listening modes that can be used with the current input source.

Selecting with the Remote Controller

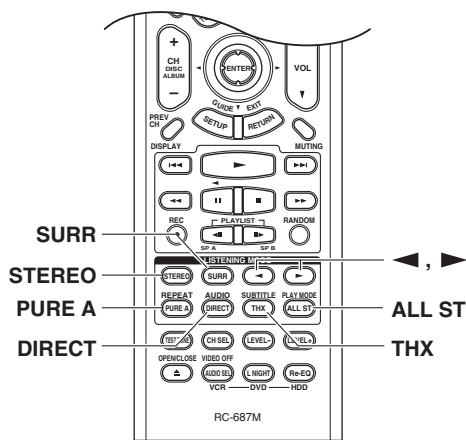

- **[STEREO] button**
This button selects the Stereo listening mode.
- **[SURR] button**
This button selects the Dolby Digital and DTS listening modes.
- **LISTENING MODE [◀]/[▶] buttons**
Pressing these buttons repeatedly cycles through all of the listening modes that can be used with the current input source.
- **[PURE A] button**
This button selects the Pure Audio listening mode. When this mode is selected, the AV receiver’s display is turned off and only video signals input through HDMI IN can be output.
- **[DIRECT] button**
This button selects the Direct listening mode.
- **[THX] button**
This button selects the THX listening modes.
- **[ALL ST] button**
This button selects the All Channel Stereo listening mode.

Using the Listening Modes—Continued

Listening Modes Available for Each Source Format

Analog and PCM Sources

✓: Available Listening Modes

Source format	Analog/PCM		Multi channel Analog	Multichannel PCM					
	32–96 kHz ^{*1}	176.4/192kHz ^{*2}		32–96 kHz ^{*1}			176.4/192 kHz ^{*2}		
				Multi channel	2ch	Mono/Multiplex	Multi channel	2ch	Mono/Multiplex
Media	CD, TV, radio,		DVD	DVD			DVD		
Listening Mode	CD, TV, radio,		DVD	DVD			DVD		
Pure Audio	✓	✓	✓	✓	✓	✓	✓	✓	✓
Direct	✓	✓	✓	✓	✓	✓	✓	✓	✓
Stereo	✓	✓		✓	✓	✓	✓	✓	✓
Mono	✓			✓	✓	✓			
Multichannel			✓	✓			✓		
Neo:6				✓ ^{*4}					
Neural THX				✓ ^{*7}	✓ ^{*5-7}				
Dolby PLII Movie/ Dolby PLIIx Movie ^{*3}	✓			✓ ^{*4}	✓				
Dolby PLII Music/ Dolby PLIIx Music ^{*3}	✓			✓ ^{*4}	✓				
Dolby PLII Game/ Dolby PLIIx Game ^{*3}	✓				✓				
Dolby EX				✓ ^{*4}					
Neo:6 Cinema	✓				✓				
Neo:6 Music	✓				✓				
THX Cinema/Music/Games ^{*5}				✓					
Dolby PLII/Dolby PLIIx Movie + THX Cinema ^{*5}	✓ ^{*3}			✓ ^{*4}	✓ ^{*3}				
Dolby PLII/Dolby PLIIx Music + THX Music ^{*5}	✓ ^{*3}			✓ ^{*4}	✓ ^{*3}				
Dolby PLII/Dolby PLIIx Game + THX Games ^{*5}	✓ ^{*3}				✓ ^{*3}				
Neo:6 Cinema/Music +THX Cinema/Music ^{*5}	✓				✓				
Neo:6 + THX Cinema/Music/Game				✓ ^{*4}					
PLII Game + THX Ultra2 Games	✓				✓				
THX Surround EX				✓ ^{*4}					
THX Ultra2 Cinema/Music/Games				✓ ^{*4}					
Neural THX + THX Cinema/Music/Games ^{*5}	✓			✓ ^{*7}	✓ ^{*7}				
MonoMovie ^{*5-6}	✓			✓	✓	✓			
Orchestra ^{*5-6}	✓			✓	✓	✓			
Unplugged ^{*5-6}	✓			✓	✓	✓			
Studio-Mix ^{*5-6}	✓			✓	✓	✓			
TV Logic ^{*5-6}	✓			✓	✓	✓			
AllChStereo	✓			✓	✓	✓			
FullMono	✓			✓	✓	✓			
T-D ^{*6}	✓			✓	✓	✓			

*1. 32/44.1/48/88.2/96kHz

*2. DVD-Audio discs output multichannel 176.4/192 kHz PCM only via HDMI.

*3. If there are no surround back speakers, or Powered Zone 2 is being used, Dolby Pro Logic II is used.

*4. Cannot be selected with some source formats.

*5. Available only when using surround speakers.

*6. PCM of 88.2kHz and 96kHz are processed at 44.1kHz and 48kHz respectively.

*7. It is possible to select it by the signal of 32-48kHz.

■ : Requires 6.1/7.1 speakers. Not available while Powered Zone 2 is being used.

■ : Requires 7.1 speakers. Not available while Powered Zone 2 is being used.

Using the Listening Modes—Continued

Dolby Digital, and Dolby Digital Plus Sources

✓: Available Listening Modes

Source format	Dolby Digital			Dolby Digital Plus		
	Multichannel	2ch	Mono/Multiplex	Multichannel	2ch	Mono/Multiplex
Media	DVD, DTV, etc.			Blu-ray, HD DVD		
Listening Mode						
Pure Audio	✓	✓	✓	✓	✓	✓
Direct	✓	✓	✓	✓	✓	✓
Stereo	✓	✓	✓	✓	✓	✓
Mono	✓	✓	✓	✓	✓	✓
Neo:6	✓ ^{*3}			✓ ^{*3}		
Neural THX	✓	✓ ^{*4}		✓	✓ ^{*4}	
DolbyDigital	✓					
DolbyDigital Plus				✓ ^{*1}		
Dolby PLII Movie/ Dolby PLIIx Movie ^{*2}	✓ ^{*3}	✓		✓ ^{*3}	✓	
Dolby PLII Music/ Dolby PLIIx Music ^{*2}	✓ ^{*3}	✓		✓ ^{*3}	✓	
Dolby PLII Game/ Dolby PLIIx Game ^{*2}		✓			✓	
Dolby EX	✓ ^{*3}	✓		✓ ^{*3}		
Neo:6 Cinema		✓			✓	
Neo:6 Music		✓			✓	
THX Cinema/Music/Games ^{*4}	✓			✓		
Dolby PLII/Dolby PLIIx Movie + THX Cinema ^{*4}	✓ ^{*3}	✓ ^{*2}		✓ ^{*3}	✓ ^{*2}	
Dolby PLII/Dolby PLIIx Music + THX Music ^{*4}	✓ ^{*3}	✓ ^{*2}		✓ ^{*3}	✓ ^{*2}	
Dolby PLII/Dolby PLIIx Game + THX Games ^{*4}		✓ ^{*2}			✓ ^{*2}	
Neo:6 Cinema/Music + THX Cinema/Music ^{*4}		✓			✓	
Neo:6 + THX Cinema/Music/Game	✓ ^{*3}			✓ ^{*3}		
PLII Game + THX Ultra2 Games		✓			✓	
THX Surround EX	✓ ^{*3}			✓ ^{*3}		
THX Ultra2 Cinema/Music/Games	✓ ^{*3}			✓ ^{*3}		
Neural THX + THX Cinema/Music/Games ^{*4}	✓	✓		✓	✓	
MonoMovie ^{*4}	✓	✓	✓	✓	✓	✓
Orchestra ^{*4}	✓	✓	✓	✓	✓	✓
Unplugged ^{*4}	✓	✓	✓	✓	✓	✓
Studio-Mix ^{*4}	✓	✓	✓	✓	✓	✓
TV Logic ^{*4}	✓	✓	✓	✓	✓	✓
AllChStereo	✓	✓	✓	✓	✓	✓
FullMono	✓	✓	✓	✓	✓	✓
T-D	✓	✓	✓	✓	✓	✓

*1. If there are no surround back speakers, depending on the input signal, Dolby Digital may be used.

*2. If there are no surround back speakers, or Powered Zone 2 is being used, Dolby Pro Logic II is used.

*3. Cannot be selected with some source formats.

*4. Available only when using surround speakers.

■ : Requires 6.1/7.1 speakers. Not available while Powered Zone 2 is being used.

■ : Requires 7.1 speakers. Not available while Powered Zone 2 is being used.

Note:

With some HD DVD and Blu-ray discs, a noise may be heard during playback. This may occur when the audio format changes during playback. It is not a malfunction.

Using the Listening Modes—Continued

DTS Sources

✓: Available Listening Modes

Source format	DTS, DTS96/24			DTS-ES Discrete/Matrix
	Multichannel	2ch	Mono	
Media	DVD, CD, etc.			DVD, CD, etc.
Listening Mode	DVD, CD, etc.			DVD, CD, etc.
Pure Audio	✓	✓	✓	✓
Direct	✓	✓	✓	✓
Stereo	✓	✓	✓	✓
Mono	✓	✓	✓	✓
DTS, DTS 96/24	✓			✓
DTS-ES Discrete/Matrix				✓ ^{*1}
Neo:6	✓ ^{*3}			
Neural THX	✓ ^{*5}	✓ ^{*4*5}		
Dolby PLII Movie/ Dolby PLIIx Movie ^{*2}	✓ ^{*3}	✓		
Dolby PLII Music/ Dolby PLIIx Music ^{*2}	✓ ^{*3}	✓		
Dolby PLII Game/ Dolby PLIIx Game ^{*2}		✓		
Dolby EX	✓ ^{*3}			
Neo:6 Cinema	✓	✓		
Neo:6 Music	✓	✓		
THX Cinema/Music/Games ^{*4}	✓			
DTS-ES Discrete/Matrix ^{*4} + THX Cinema/Music/Games				✓ ^{*1}
Dolby PLII/Dolby PLIIx Movie + THX Cinema/Music ^{*4}	✓ ^{*3}	✓ ^{*2}		
Dolby PLII/Dolby PLIIx Music + THX Music ^{*4}		✓ ^{*2}		
Dolby PLII/Dolby PLIIx Game + THX Games ^{*4}		✓ ^{*2}		
Neo:6 Cinema/Music + THX Cinema/Music ^{*4}		✓		
Neo:6 + THX Cinema/Music/Game	✓ ^{*3}			
PLII Game + THX Ultra2 Games		✓		
THX Surround EX	✓ ^{*3}			
THX Ultra2 Cinema/Music/Games	✓ ^{*3}			
Neural THX + THX Cinema/Music/Games ^{*4}	✓ ^{*5}	✓ ^{*5}		
MonoMovie ^{*4*5}	✓	✓	✓	✓
Orchestra ^{*4*5}	✓	✓	✓	✓
Unplugged ^{*4*5}	✓	✓	✓	✓
Studio-Mix ^{*4*5}	✓	✓	✓	✓
TV Logic ^{*4*5}	✓	✓	✓	✓
AllChStereo	✓	✓	✓	✓
FullMono	✓	✓	✓	✓
T-D ^{*5}	✓	✓	✓	✓

*1. If there are no surround back speakers, or Powered Zone 2 is being used, DTS is used.

*2. If there are no surround back speakers, or Powered Zone 2 is being used, Dolby Pro Logic II is used.

*3. Cannot be selected with some source formats.

*4. Available only when using surround speakers.

*5. DTS 96/24 is processed as DTS.

■ : Requires 6.1/7.1 speakers. Not available while Powered Zone 2 is being used.

■ : Requires 7.1 speakers. Not available while Powered Zone 2 is being used.

Using the Listening Modes—Continued

TrueHD Sources

✔: Available Listening Modes

Source format	TrueHD			TrueHD 192kHz		
	Multichannel	2ch	Mono/Multiplex	Multichannel	2ch	Mono/Multiplex
Media	Blu-ray, HD DVD			Blu-ray, HD DVD		
Listening Mode	Blu-ray, HD DVD			Blu-ray, HD DVD		
Pure Audio	✔	✔	✔	✔	✔	
Direct	✔	✔	✔	✔	✔	
Stereo	✔	✔	✔	✔	✔	
Mono	✔	✔	✔			
TrueHD	✔			✔		
Neo:6	✔ ^{*2}					
Neural THX	✔ ^{*4}	✔ ^{*3*4}				
Dolby PLII Movie/ Dolby PLIIx Movie ^{*1}	✔ ^{*2}	✔				
Dolby PLII Music/ Dolby PLIIx Music ^{*1}	✔ ^{*2}	✔				
Dolby PLII Game/ Dolby PLIIx Game ^{*1}		✔				
Dolby EX	✔ ^{*2}					
Neo:6 Cinema		✔				
Neo:6 Music		✔				
THX Cinema/Music/Games ^{*3}	✔					
Dolby PLII/Dolby PLIIx Movie + THX Cinema ^{*3}	✔ ^{*2}	✔ ^{*1}				
Dolby PLII/Dolby PLIIx Music + THX Music ^{*3}	✔ ^{*2}	✔ ^{*1}				
Dolby PLII/Dolby PLIIx Game + THX Games ^{*3}		✔ ^{*1}				
Neo:6 Cinema/Music + THX Cinema/Music ^{*3}		✔				
Neo:6 + THX Cinema/Music/Game	✔ ^{*2}					
PLII Game + THX Ultra2 Cinema		✔				
THX Surround EX	✔ ^{*2}					
THX Ultra2 Cinema/Music/Games	✔ ^{*2}					
Neural THX + THX Cinema/Music/Games ^{*3}	✔ ^{*4}	✔ ^{*4}				
MonoMovie ^{*3}	✔	✔	✔			
Orchestra ^{*3}	✔	✔	✔			
Unplugged ^{*3}	✔	✔	✔			
Studio-Mix ^{*3}	✔	✔	✔			
TV Logic ^{*3}	✔	✔	✔			
AllChStereo	✔	✔	✔			
FullMono	✔	✔	✔			
T-D	✔	✔	✔			

*1. If there are no surround back speakers, or Powered Zone 2 is being used, Dolby Pro Logic II is used.

*2. Cannot be selected with some source formats.

*3. Available only when using surround speakers.

*4. It is possible to select it by the signal of 32-48kHz.

■ : Requires 6.1/7.1 speakers. Not available while Powered Zone 2 is being used.

■ : Requires 7.1 speakers. Not available while Powered Zone 2 is being used.

Note:

With some HD DVD and Blu-ray discs, a noise may be heard during playback. This may occur when the audio format changes during playback. It is not a malfunction.

Using the Listening Modes—Continued

DTS-HD Sources

✓: Available Listening Modes

Source format	DTS-HD High Resolution			DTS-HD Master Audio			DTS-HD Master Audio 192kHz		
	Multi channel	2ch	Mono	Multi channel	2ch	Mono	Multi channel	2ch	Mono
Media	Blu-ray, HD DVD			Blu-ray, HD DVD			Blu-ray, HD DVD		
Listening Mode	Blu-ray, HD DVD			Blu-ray, HD DVD			Blu-ray, HD DVD		
Pure Audio	✓	✓	✓	✓	✓	✓	✓	✓	
Direct	✓	✓	✓	✓	✓	✓	✓	✓	
Stereo	✓	✓	✓	✓	✓	✓	✓	✓	
Mono	✓	✓	✓	✓	✓	✓			
DTS-HD High Resolution	✓								
DTS-HD Master Audio				✓			✓		
Neo:6	✓ ^{*2}			✓ ^{*2}					
Neural THX	✓ ^{*4}	✓ ^{*3*4}		✓ ^{*4}	✓ ^{*3*4}				
Dolby PLII Movie/ Dolby PLIIx Movie ^{*1}	✓ ^{*2}	✓		✓ ^{*2}	✓				
Dolby PLII Music/ Dolby PLIIx Music ^{*1}	✓ ^{*2}	✓		✓ ^{*2}	✓				
Dolby PLII Game/ Dolby PLIIx Game ^{*1}		✓			✓				
Dolby EX	✓ ^{*2}			✓ ^{*2}					
Neo:6 Cinema		✓			✓				
Neo:6 Music		✓			✓				
THX Cinema/Music/Games ^{*3}	✓			✓					
Dolby PLII/Dolby PLIIx Movie + THX Cinema ^{*3}	✓ ^{*2}	✓ ^{*1}		✓ ^{*2}	✓ ^{*1}				
Dolby PLII/Dolby PLIIx Music + THX Music ^{*3}	✓ ^{*2}	✓ ^{*1}		✓ ^{*2}	✓ ^{*1}				
Dolby PLII/Dolby PLIIx Game + THX Games ^{*3}		✓ ^{*1}			✓ ^{*1}				
Neo:6 Cinema/Music + THX Cinema/Music ^{*3}		✓			✓				
Neo:6 + THX Cinema/Music/Game	✓ ^{*2}			✓ ^{*2}					
PLII Game + THX Ultra2 Games		✓			✓				
THX Surround EX	✓ ^{*2}			✓ ^{*2}					
THX Ultra2 Cinema/Music/Games	✓ ^{*2}			✓ ^{*2}					
Neural THX + THX Cinema/Music/Games ^{*3}	✓ ^{*4}	✓ ^{*4}		✓ ^{*4}	✓ ^{*4}				
MonoMovie ^{*3}	✓	✓	✓	✓	✓	✓			
Orchestra ^{*3}	✓	✓	✓	✓	✓	✓			
Unplugged ^{*3}	✓	✓	✓	✓	✓	✓			
Studio-Mix ^{*3}	✓	✓	✓	✓	✓	✓			
TV Logic ^{*3}	✓	✓	✓	✓	✓	✓			
AllChStereo	✓	✓	✓	✓	✓	✓			
FullMono	✓	✓	✓	✓	✓	✓			
T-D	✓	✓	✓	✓	✓	✓			

*1. If there are no surround back speakers, or Powered Zone 2 is being used, Dolby Pro Logic II is used.

*2. Cannot be selected with some source formats.

*3. Available only when using surround speakers.

*4. It is possible to select it by the signal of 32-48kHz.

■ : Requires 6.1/7.1 speakers. Not available while Powered Zone 2 is being used.

■ : Requires 7.1 speakers. Not available while Powered Zone 2 is being used.

Note:

With some HD DVD and Blu-ray discs, a noise may be heard during playback. This may occur when the audio format changes during playback. It is not a malfunction.

Using the Listening Modes—Continued

DTS Express and DSD Sources

✓: Available Listening Modes

Source format	DTS Express			DSD ^{*1}	
	Multichannel	2ch	Mono	Multichannel (3/2.1)	2ch
Media	Blu-ray, HD DVD			SACD	
Listening Mode					
Pure Audio	✓	✓	✓	✓	✓
Direct	✓	✓	✓	✓	✓
Stereo	✓	✓	✓	✓	✓
Mono	✓	✓	✓	✓	✓
DTS Express	✓				
DSD				✓	
Neo:6	✓ ^{*3}			✓	
Neural THX	✓	✓ ^{*4}		✓	✓ ^{*4}
Dolby PLII Movie/ Dolby PLIIx Movie ^{*2}	✓ ^{*3}	✓		✓	✓
Dolby PLII Music/ Dolby PLIIx Music ^{*2}	✓ ^{*3}	✓		✓	✓
Dolby PLII Game/ Dolby PLIIx Game ^{*2}		✓			✓
Dolby EX	✓ ^{*3}			✓	
Neo:6 Cinema		✓			✓
Neo:6 Music		✓			✓
THX Cinema/Music/Games ^{*4}	✓			✓	
Dolby PLII/Dolby PLIIx Movie + THX Cinema ^{*4}	✓ ^{*3}	✓ ^{*2}		✓	✓ ^{*2}
Dolby PLII/Dolby PLIIx Music + THX Music ^{*4}	✓ ^{*3}	✓ ^{*2}		✓	✓ ^{*2}
Dolby PLII/Dolby PLIIx Game + THX Games ^{*4}		✓ ^{*2}			✓ ^{*2}
Neo:6 Cinema/Music + THX Cinema/Music ^{*4}		✓			✓
Neo:6 + THX Cinema/Music/Game	✓ ^{*3}			✓	
PLII Game + THX Ultra2 Games		✓			✓
THX Surround EX	✓ ^{*3}			✓	
THX Ultra2 Cinema/Music/Games	✓ ^{*3}			✓	
Neural THX + THX Cinema/Music/Games ^{*4}	✓	✓		✓	✓
MonoMovie ^{*4}	✓	✓	✓	✓	✓
Orchestra ^{*4}	✓	✓	✓	✓	✓
Unplugged ^{*4}	✓	✓	✓	✓	✓
Studio-Mix ^{*4}	✓	✓	✓	✓	✓
TV Logic ^{*4}	✓	✓	✓	✓	✓
AllChStereo	✓	✓	✓	✓	✓
FullMono	✓	✓	✓	✓	✓
T-D	✓	✓	✓	✓	✓

*1. DSD sources are converted and handled as PCM.

*2. If there are no surround back speakers, or Powered Zone 2 is being used, Dolby Pro Logic II is used.

*3. Cannot be selected with some source formats.

*4. Available only when using surround speakers.

■ : Requires 6.1/7.1 speakers. Not available while Powered Zone 2 is being used.

■ : Requires 7.1 speakers. Not available while Powered Zone 2 is being used.



If you can select PCM or DSD output on your SACD player, in some cases, selecting PCM will provide the best sound quality.

Note:

With some HD DVD and Blu-ray discs, a noise may be heard during playback. This may occur when the audio format changes during playback. It is not a malfunction.

About the Listening Modes

The AV receiver's listening modes can transform your listening room into a movie theater or concert hall, with high fidelity and stunning surround sound.

The LISTENING MODE button illustration shows that listening modes can be selected.

Button: 

The LISTENING MODE button illustration shows the remote controller buttons with the exception of the [PURE A] button (All buttons with the exception of the [PURE A] button are on both the AV receiver and the remote controller).

See “Selecting the Listening Modes” on page 81 for information on the use of the LISTENING MODE buttons.

Pure Audio

Button:  

In this mode, the display and video circuitry are turned off, minimizing possible noise sources for the ultimate in high-fidelity reproduction. (As the video circuitry is turned off, only video signals input through HDMI IN can be output.)

Note:

- The Pure Audio listening mode cannot be selected while Zone 2 is on.

Direct

Button: 

In this mode, audio from the input source is output directly with minimal processing, providing high-fidelity reproduction. All of the source's audio channels are output as they are.

Stereo

Button: 

Sound is output by the front left and right speakers and subwoofer.

Mono

Use this mode when watching an old movie with a mono soundtrack, or use it with the foreign language soundtracks recorded in the left and right channels of some movies. It can also be used with DVDs or other sources containing multiplexed audio, such as karaoke DVDs.

Multichannel

This mode is for use with analog or PCM multichannel sources.

Dolby Pro Logic IIx

Dolby Pro Logic II

Dolby Pro Logic IIx expands any 2-channel source for 7.1-channel playback. It provides a very natural and seamless surround-sound experience that fully envelops the listener. As well as music and movies, video games can also benefit from the dramatic spatial effects and vivid imaging. If you're not using any surround back speakers, **Dolby Pro Logic II** will be used instead of Dolby Pro Logic IIx.

- **Dolby PLIIx Movie**

Use this mode with any stereo or Dolby Surround (Pro Logic) movie (e.g., TV, DVD, VHS).

- **Dolby PLIIx Music**

Use this mode with any stereo or Dolby Surround (Pro Logic) music source (e.g., CD, radio, cassette, TV, VHS, DVD).

- **Dolby PLIIx Game**

Use this mode with video games, especially those that bear the Dolby Pro Logic II logo.

Dolby Digital

Use this mode with DVDs that bear the Dolby Digital logo, and Dolby Digital TV broadcasts. This is the most common digital surround-sound format, and it'll put you right in the middle of the action, just like being in a movie theater or concert hall.

5.1-channel source + Dolby EX

These modes expand 5.1-channel sources for 6.1/7.1-channel playback. They're especially suited to Dolby EX soundtracks that include a matrix-encoded surround back channel. The additional channel adds an extra dimension and provides an enveloping surround sound experience, perfect for rotating and fly-by sound effects.

Dolby Digital Plus

Developed for use with HDTV, including the new video disc formats Blu-ray and HD DVD, this is the latest multichannel audio format from Dolby. It supports up to 7.1 channels with 48 kHz sampling rate.

Dolby TrueHD

Designed to take full advantage of the additional storage space offered by the new Blu-ray and HD DVD disc formats, this new Dolby format offers up to 7.1 discrete channels of digital audio with 48/96 kHz, up to 5.1-channels with 192 kHz sampling rate.

For the signals supported by the AV receiver, see page 84.

5.1-channel source + Dolby PLIIx Music

These modes use the Dolby Pro Logic IIx Music mode to expand 5.1-channel sources for 6.1/7.1-channel playback.

5.1-channel source + Dolby PLIIx Movie

These modes use the Dolby Pro Logic IIx Movie mode to expand 5.1-channel sources for 7.1-channel playback.

DTS

The DTS digital surround-sound format supports up to 5.1 discrete channels and uses less compression for high-fidelity reproduction. Use it with DVDs and CDs that bear the DTS logo.

DTS 96/24

This mode is for use with DTS 96/24 sources. This is high-resolution DTS with a 96 kHz sampling rate and 24-bit resolution, providing superior fidelity. Use it with DVDs that bear the DTS 96/24 logo.

DTS-ES Discrete

This mode is for use with DTS-ES Discrete soundtracks, which use a discrete surround back channel for true 6.1/7.1-channel playback. The seven totally separate audio channels provide better spatial imaging and 360-degree sound localization, perfect for sounds that pan across the surround channels. Use it with DVDs that bear the DTS-ES logo, especially those with a DTS-ES Discrete soundtrack.

DTS-ES Matrix

This mode is for use with DTS-ES Matrix soundtracks, which use a matrix-encoded back-channel for 6.1/7.1-channel playback. Use it with DVDs that bear the DTS-ES logo, especially those with a DTS-ES Matrix soundtrack.

DTS Neo:6

This mode expands any 2-channel source for up to 7.1-channel playback. It uses seven full-bandwidth channels of matrix decoding for matrix-encoded material, providing a very natural and seamless surround sound experience that fully envelops the listener.

- **Neo:6 Cinema**

Use this mode with any stereo movie (e.g., TV, DVD, VHS).

- **Neo:6 Music**

Use this mode with any stereo music source (e.g., CD, radio, cassette, TV, VHS, DVD).

5.1-channel source + Neo:6

This mode uses Neo:6 to expand 5.1-channel sources for 6.1/7.1-channel playback.

DTS-HD High Resolution Audio

Developed for use with HDTV, including the new video disc formats Blu-ray and HD DVD, this is the latest multichannel audio format from DTS. It supports up to 7.1 channels with 96 kHz sampling rate.

DTS-HD Master Audio

Designed to take full advantage of the additional storage space offered by the new Blu-ray and HD DVD disc formats, this new DTS format offers up to 7.1 discrete channels of digital audio with 48/96 kHz, up to 5.1-channels with 192 kHz sampling rate.

For the signals supported by the AV receiver, see page 86.

DTS Express

This format supports up to 5.1 channels and a lower sampling rate of 48 kHz. Applications include interactive audio and commentary encoding for HD DVD Sub Audio and Blu-ray Secondary Audio. Also broadcast and media servers.

Neural THX 5.1/7.1

Neural-THX Surround employs psychoacoustic frequency domain processing, which allows delivery of a more detailed sound stage, with superior channel separation and localization of audio elements. The Neural THX 5.1 and Neural THX 7.1 modes can expand any 2-channel stereo source for 5.1- or 7.1-channel playback, respectively. Use them with CD, radio, cassette, TV, VHS, DVD, and other 2-channel stereo sources, including video games. Neural-THX Surround can also be used by broadcasters to encode and transmit surround-sound content over a stereo signal, which listeners can enjoy as either surround sound or normal stereo. XM Satellite Radio, for example, is using Neural-THX Surround on select channels, which the AV receiver can expand from 5.1 channels to 7.1 channels.

DSD

DSD stands for *Direct Stream Digital* and is the format used to store digital audio on Super Audio CDs (SACD). This mode can be used with SACDs that feature multichannel audio.

THX

Founded by George Lucas, THX develops stringent standards that ensure movies are reproduced in movie theaters and home theaters just as the director intended.

THX Modes carefully optimize the tonal and spatial characteristics of the soundtrack for reproduction in the home-theater environment. They can be used with 2-channel matrixed and multichannel sources.

Surround back speaker output depends on the source material and the selected listening mode.

- **THX Cinema**

THX Cinema mode corrects theatrical soundtracks for playback in a home theater environment. In this mode, THX Loudness Plus is configured for cinema levels and Re-EQ, Timbre Matching, and Adaptive Decorrelation are active.

- **THX Music**

THX Music mode is tailored for listening to music, which is typically mastered at significantly higher levels than movies. In this mode, THX Loudness Plus is configured for music playback and only Timbre Matching is active.

- **THX Games**

THX Games mode is meant for spatially accurate playback of game audio, which is often mixed similarly to movies but in a smaller environment. THX Loudness Plus is configured for game audio levels, with Timbre Matching active.

- **THX Ultra2 Cinema**

This mode expands 5.1-channel sources for 7.1-channel playback. It does this by analyzing the composition of the surround source, optimizing the ambient and directional sounds to produce the surround back channel output.

- **THX Ultra2 Music**

This mode is designed for use with music. It expands 5.1-channel sources for 7.1-channel playback.

- **THX Ultra2 Games**

This mode is designed for use with video games. It can expand 5.1-channel sources for 6.1/7.1-channel playback.

- **THX Surround EX**

This mode expands 5.1-channel sources for 6.1/7.1-channel playback. It's especially suited to Dolby Digital EX sources. THX Surround EX, also known as Dolby Digital Surround EX, is a joint development between Dolby Laboratories and THX Ltd.

Onkyo Original DSP Modes

Mono Movie

This mode is suitable for old movies and other mono sources. The center speaker outputs the sound as it is, while reverb is applied to the sound output by the other speakers, giving presence to even mono material.

Orchestra

Suitable for classical or operatic music, this mode emphasizes the surround channels in order to widen the stereo image, and simulates the natural reverberation of a large hall.

Unplugged

Suitable for acoustic instruments, vocals, and jazz, this mode emphasizes the front stereo image, giving the impression of being right in front of the stage.

Studio-Mix

Suitable for rock or pop music, listening to music in this mode creates a lively sound field with a powerful acoustic image, like being at a club or rock concert.

TV Logic

This mode adds realistic acoustics to TV shows produced in a TV studio, surround effects to the entire sound, and clarity to voices.

All Ch Stereo

Ideal for background music, this mode fills the entire listening area with stereo sound from the front, surround, and surround back speakers.

Full Mono

In this mode, all speakers output the same sound in mono, so the sound you hear is the same regardless of where you are within the listening room.

T-D (Theater-Dimensional)

With this mode you can enjoy a virtual 5.1 surround sound even with only two or three speakers. This works by controlling how sounds reach the listener's left and right ears. Good results may not be possible if there's too much reverb, so we recommend that you use this mode in an environment with little or no natural reverb.

Advanced Setup

The onscreen setup menus appear on the connected TV and provide a convenient way to change the AV receiver's various settings. Settings are organized into eight categories on the **main menu**, most containing a **submenu**.

The onscreen menus shown in this manual may be slightly different from what you see on your TV.

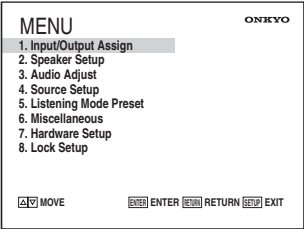

Menu Map

The following map shows how the setup menus are organized. Use the page numbers to locate information about items.

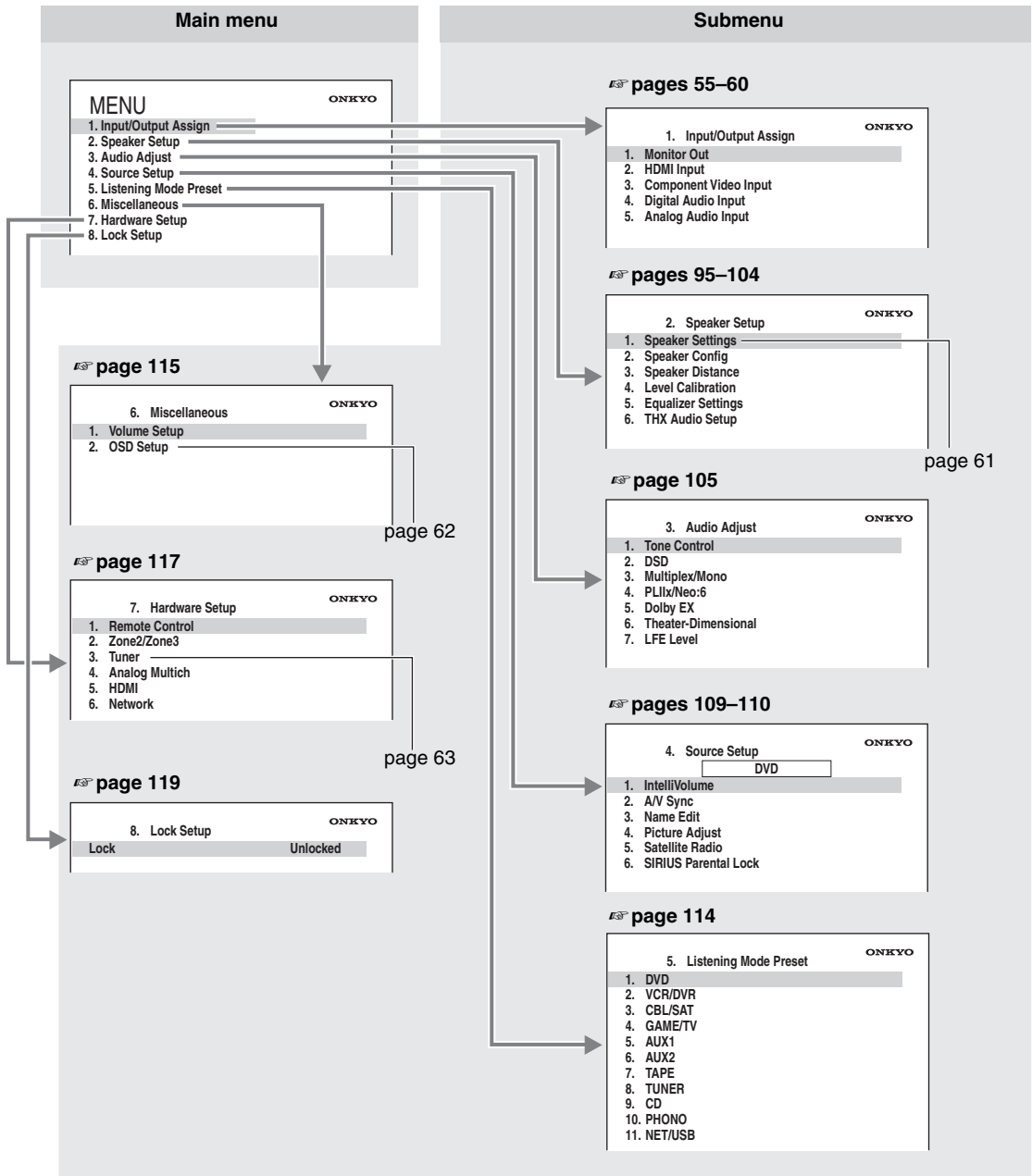

Monitor Out Setup

This section explains items on the “Input/Output Assign” menu.

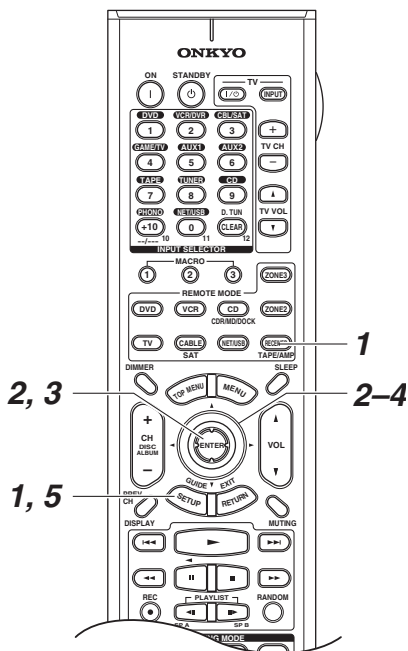

1

Press the [RECEIVER] button, followed by the [SETUP] button.

The main menu appears onscreen.

If the main menu doesn't appear, make sure the appropriate external input is selected on your TV.



2

Use the Up and Down [▲]/[▼] buttons to select “1. Input/Output Assign”, and then press [ENTER].

The “Input/Output Assign” menu appears.

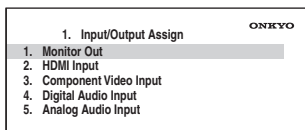
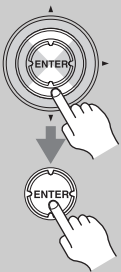

3

Use the Up and Down [▲]/[▼] buttons to select an item, and then press [ENTER].

The screen for that item appears.



4

Use the Up and Down [▲]/[▼] buttons to select an item, and use the Left and Right [◀]/[▶] buttons to change it.

The items are explained below.

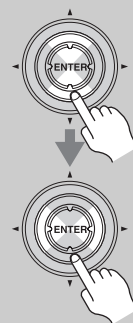

5

When you've finished, press the [SETUP] button.

Setup closes.



Note:

This procedure can also be performed on the AV receiver by using its [SETUP] button, arrow buttons, and [ENTER] button.

Monitor Out

Resolution

You can specify the output resolution for the HDMI outputs and have the AV receiver upconvert the picture resolution as necessary to match the resolution supported by your TV.

Through: Select this to pass video through the AV receiver at the same resolution and with no conversion (default).

Auto: Select this to have the AV receiver automatically convert video at resolutions not supported by your TV.
(Not available when the “Monitor Out” setting is set to “Analog”.)

480p (480/576p):

Select this for 480p or 576p output and video conversion as necessary.

720p: Select this for 720p output and video conversion as necessary.

1080i: Select this for 1080i output and video conversion as necessary.

1080p: Select this for 1080p output and video conversion as necessary.
(Not available when the “Monitor Out” setting is set to “Analog”.)

Source: Output will be according to the resolution level which was set with Resolution inside Source: 4-4. Picture Adjust. (Setting for each Source becomes possible.)

Brightness

With this setting you can adjust the picture brightness. Can be adjusted from –50 to +50 in steps of 1 (default is 0).

“–50” is the darkest.

“+50” is the brightest.

Contrast

With this setting you can adjust Contrast. Can be adjusted from –50 to +50 in steps of 1 (default is 0).

“–50” is the least.

“+50” is the greatest.

Hue

With this setting you can adjust the red/green balance. Can be adjusted from –20 to +20 in steps of 1 (default is 0).

“–20” is the strongest green.

“+20” is the strongest red.

Saturation

With this setting you can adjust saturation. Can be adjusted from –50 to +50 in steps of 1 (default is 0).

“–50” is the weakest color.

“+50” is the strongest color.

Gamma

Adjust the balance of incoming picture R (red), G (green), and B (blue) color data signal to the output color data signal.

Can be adjusted from –3 to +3 in steps of 1 (default is 0).

R Brightness

With this setting you can adjust the picture red brightness.

Can be adjusted from –50 to +50 in steps of 1 (default is 0).

“–50” is the darkest.

“+50” is the brightest.

R Contrast

With this setting you can adjust red Contrast.

Can be adjusted from –50 to +50 in steps of 1 (default is 0).

“–50” is the least.

“+50” is the greatest.

G Brightness

With this setting you can adjust the picture green brightness.

Can be adjusted from –50 to +50 in steps of 1 (default is 0).

“–50” is the darkest.

“+50” is the brightest.

G Contrast

With this setting you can adjust green Contrast.

Can be adjusted from –50 to +50 in steps of 1 (default is 0).

“–50” is the least.

“+50” is the greatest.

B Brightness

With this setting you can adjust the picture blue brightness.

Can be adjusted from –50 to +50 in steps of 1 (default is 0).

“–50” is the darkest.

“+50” is the brightest.

B Contrast

With this setting you can adjust blue Contrast.

Can be adjusted from –50 to +50 in steps of 1 (default is 0).

“–50” is the least.

“+50” is the greatest.

Speaker Setup

This section explains items on the “Speaker Setup” menu.

Some of the speaker settings are set automatically by the Automatic Speaker Setup function (see page 64).

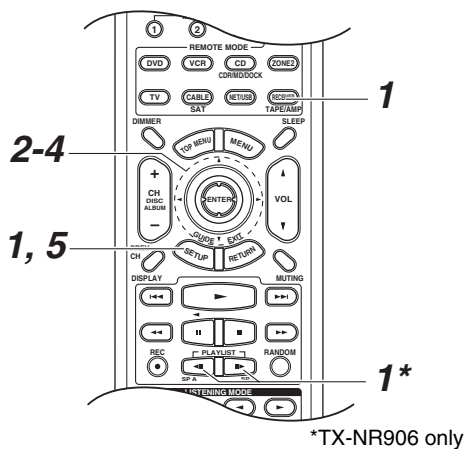

*TX-NR906 only

Speaker Settings

See “Speaker Settings” on page 61.

Speaker Configuration

These settings are set automatically by the Automatic Speaker Setup function (see page 64).

With the Speaker Configuration settings, you can specify which speakers are connected and a crossover frequency, distance, and level for each speaker.

You can choose which of the speakers you want to use with the Speakers A and Speakers B configurations, and set the crossover frequencies, distances, and levels of the front Speakers A and front Speakers B independently. The other speakers (i.e., subwoofer, center, surround, and surround back) use the same crossover frequencies, distances, and levels for Speakers A and Speakers B.

The following crossover frequencies can be specified: Full Band, 40 Hz, 50 Hz, 60 Hz, 70 Hz, 80 Hz (THX), 90 Hz, 100 Hz, 110 Hz, 120 Hz, 130 Hz, 150 Hz, or 200 Hz.

Specify Full Band for speakers that can output low-frequency bass sounds adequately, for example, speakers with a good sized woofer. For smaller speakers, specify a crossover frequency. Sounds below the crossover frequency will then be output by the subwoofer instead of the speaker. Refer to your speakers’ manuals to determine the optimum crossover frequencies.

If you’re using THX-certified speakers, specify 80 Hz (THX) for all speakers.

1

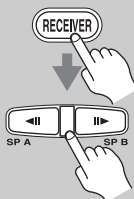

Press the [RECEIVER] REMOTE MODE button, and then use the remote controller’s [SP A] or [SP B] button to select Speakers A or Speakers B, respectively (TX-NR906 only).

Note:

- Speakers B cannot be selected if “Speaker Type: Front(Speaker B)” is set to “Not Use”.
- TX-SR876 continue with step 2 after press the [RECEIVER] REMOTE MODE button.

2



Press the [SETUP] button. The main menu appears onscreen.

3



Use the Up and Down [▲]/[▼] buttons to select “2. Speaker Setup”, and then press [ENTER]. The “Speaker Setup” menu appears.

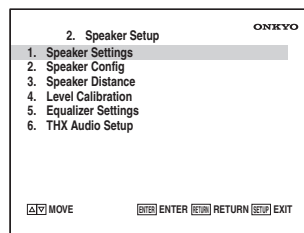

4

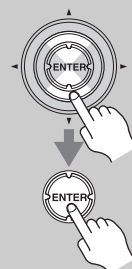

Use the Up and Down [▲]/[▼] buttons to select “2. Speaker Config”, and then press [ENTER]. The “Speaker Config” screen appears.

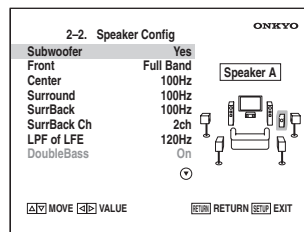

5

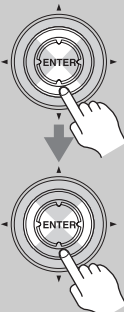

Use the Up and Down [▲]/[▼] buttons to select “Subwoofer”, and then use the Left and Right [◀]/[▶] buttons to select:

Yes: Select if a subwoofer is connected.

No: Select if no subwoofer is connected.

Note:
The same setting is used for Speakers A and Speakers B.

6

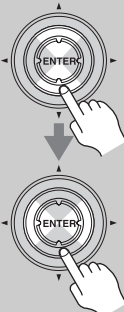

Use the Up and Down [▲]/[▼] buttons to select “Front”, and then use the Left and Right [◀]/[▶] buttons to select a crossover frequency.

Notes:

- This setting can be set independently for front Speakers A and front Speakers B.
- Fixed at “Full Band” if “Subwoofer” (step 5) is set to “No”.

7

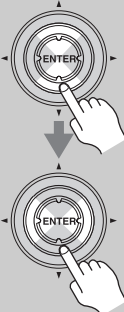

Use the Up and Down [▲]/[▼] buttons to select “Center”, and then use the Left and Right [◀]/[▶] buttons to select a crossover frequency.

If no center speaker is connected, select None.

Notes:

- The same setting is used for Speakers A and Speakers B.
- Can be set if the currently selected speakers (Speakers A or Speakers B) is set to “BTL” (page 61).
- Cannot select “Full Band” if “Front” (step 6) is set to anything other than “Full Band”.
- For Speakers B, if any channel is set to “Full Band”, “Center” is fixed at “Full Band”.

8

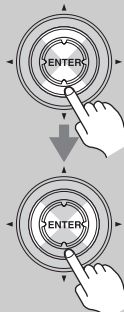

Use the Up and Down [▲]/[▼] buttons to select “Surround”, and then use the Left and Right [◀]/[▶] buttons to select a crossover frequency.

If no surround left and right speakers are connected, select “None”.

Notes:

- The same setting is used for Speakers A and Speakers B.
- Can be set if the currently selected speakers (Speakers A or Speakers B) is set to “BTL” (page 61).
- Cannot select “Full Band” if “Front” (step 6) is set to anything other than “Full Band”.

9



Use the Up and Down [▲]/[▼] buttons to select “SurrBack”, and then use the Left and Right [◀]/[▶] buttons to select a crossover frequency.

If no surround back speakers are connected, select “None”.

Notes:

- The same setting is used for Speakers A and Speakers B.
- Cannot be set if “Speaker Type: Front(Speaker A) or Front(Speaker B)” is set to “Bi-Amp” or “BTL” (page 61), “Surround” is set to “None” (step 8), or “Powered Zone2” is being used (page 132).
- Cannot select “Full Band” if “Surround” (step 8) is set to anything other than “Full Band”.

10



Use the Up and Down [▲]/[▼] buttons to select “SurrBack Ch”, and then use the Left and Right [◀]/[▶] buttons to select:

1ch: Select if one surround back speaker is connected.

2ch: Select if two (left and right) surround back speakers are connected.

Notes:

- The same setting is used for Speakers A and Speakers B.
- Cannot be set if “Speaker Type: Front(Speaker A) or Front(Speaker B)” is set to “Bi-Amp” or “BTL” (page 61), “SurrBack” is set to “None” (step 9), or “Powered Zone2” is being used (page 132).

Continue with step 11 on the next page.

Low-Pass Filter for the LFE Channel

This setting is *not* set automatically by the Automatic Speaker Setup function (see page 64).

With this setting, you can specify the cutoff frequency of the LFE channel's low-pass filter (LPF), which can be used to filter out unwanted hum. The LPF only applies to sources that use the LFE channel.

*If you're using THX-certified speakers, select "80Hz(THX)".

11

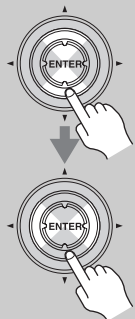

Use the Up and Down [▲]/[▼] buttons to select "LPF of LFE", and then use the Left and Right [◀]/[▶] buttons to select a low-pass filter frequency.

The following low-pass filter frequencies can be selected: "80Hz(THX)", "90Hz", "100Hz", "110Hz", or "120Hz".

Note:

The same setting is used for Speakers A and Speakers B.

Continue with step 12 in the next column.

Double Bass

This setting is *not* set automatically by the Automatic Speaker Setup function (see page 64).

With this setting, you can boost bass output by feeding front left and right channel bass sounds to the subwoofer. This setting can only be made if the "Subwoofer" setting in step 4 is set to "Yes", and the "Front" setting in step 5 is set to "Full Band".

*If you're using THX-certified speakers, select "Off(THX)".

12

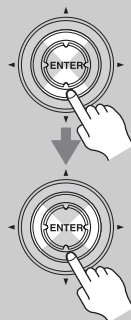

Use the Up and Down [▲]/[▼] buttons to select "DoubleBass", and then use the Left and Right [◀]/[▶] buttons to select:

Off(THX):

The subwoofer only outputs the LFE channel.

On:

In addition to LFE channel sounds, the subwoofer outputs front left and right channel bass sounds.

Note:

- The same setting is used for Speakers A and Speakers B.

Continue with step 13 on the next page (TX-NR906 only).

TX-SR876 continue with step 18 on page 99.

**Setting Speakers A and Speakers B
(TX-NR906 only)**

These settings are *not* set automatically by the Automatic Speaker Setup function (see page 64).

If you're using Speakers B, you can choose whether or not to use the subwoofer, center, surround, and surround back speakers with the Speakers A and Speakers B configurations independently. You cannot choose whether or not to use the front speakers.

Use the remote controller's [SPA] or [SPB] button to select Speakers A or Speakers B, respectively.

13



Press the Down [▼] button to display the bottom half of the “Speaker Config” screen.

2-2. Speaker Config ONKYO

Subwoofer	Not Use	Speaker A
Front	Use	
Center	Not Use	
Surround	Use	
SurrBack	Use	

⏪ MOVE ⏩ VALUE ⏴ RETURN ⏵ EXIT

Notes:

- The bottom half of the “Speaker Config” screen can only be displayed when the “Speaker Type: Front(Speaker B)” setting is set to something other than “Not Use” (page 61).
- You can switch between the Speakers A and Speakers B settings on either half of the “Speaker Config” screen.

14

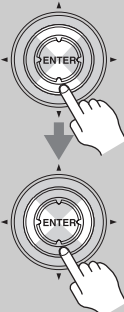

Use the Up and Down [▲]/[▼] buttons to select “Subwoofer”, and then use the Left and Right [◀]/[▶] buttons to select:

Not Use: Select if you don't want to use the subwoofer with Speakers A or Speakers B.

Use: Select if you do want to use the subwoofer with Speakers A or Speakers B.

Note:
Cannot be set if “Subwoofer” (step 5) is set to “No”.

15

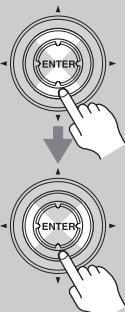

Use the Up and Down [▲]/[▼] buttons to select “Center”, and then use the Left and Right [◀]/[▶] buttons to select:

Not Use: Select if you don't want to use the center speaker with Speakers A or Speakers B.

Use: Select if you do want to use the center speaker with Speakers A or Speakers B.

Note:
Cannot be set if the “Center” (step 7) is set to “None”.

16



Use the Up and Down [▲]/[▼] buttons to select “Surround”, and then use the Left and Right [◀]/[▶] buttons to select:

Not Use: Select if you don't want to use the surround speakers with Speakers A or Speakers B.

Use: Select if you do want to use the surround speakers with Speakers A or Speakers B.

Note:
Cannot be set if the “Center” (step 8) is set to “None”.

17

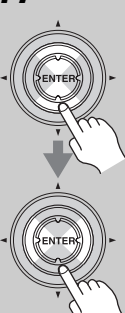

Use the Up and Down [▲]/[▼] buttons to select “SurrBack”, and then use the Left and Right [◀]/[▶] buttons to select:

Not Use: Select if you don't want to use the surr back speakers with Speakers A or Speakers B.

Use: Select if you do want to use the surr back speakers with Speakers A or Speakers B.

Note:

- Fixed at “Not Use” if “Surround” (step 16) is set to “Not Use”.
- Cannot be set if “Speaker Type: Front(Speaker B)” is set to “Bi-Amp” or “BTL” (page 61), “SurrBack” is set to “None” (step 9), or “Powered Zone2” is being used (page 132).

18

Press the [SETUP] button.
Setup closes.



Note:

This procedure can also be performed on the AV receiver by using its [SETUP] button, arrow buttons, and [ENTER] button.

Speaker Distance

These settings are set automatically by the Automatic Speaker Setup function (see page 64).

With the “Speaker Distance” settings, you can specify the distance from each speaker to the listening position. You can set the distances for front Speakers A and front Speakers B independently. The other speakers (i.e., subwoofer, center, surround, and surround back) use the same distance settings for Speakers A and Speakers B.

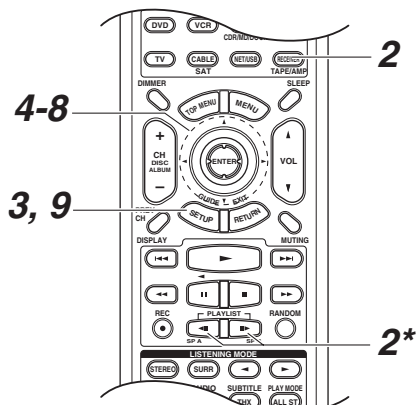

*TX-NR906 only

1

Measure and make a note of the distance from each speaker to the listening position.

2

Press the [RECEIVER] REMOTE MODE button, and then use the remote controller’s [SP A] or [SP B] button to select Speakers A or Speakers B, respectively (TX-NR906 only).

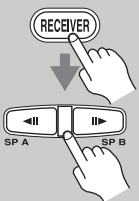

Note:

- Speakers B cannot be selected if “Speaker Type: Front(Speaker B)” is set to “Not Use”.
- TX-SR876 continue with step 3 after press the [RECEIVER] REMOTE MODE button.

3

Press the [SETUP] button.
The main menu appears onscreen.



4

Use the Up and Down [▲]/[▼] buttons to select “2. Speaker Setup”, and then press [ENTER].
The “Speaker Setup” menu appears.

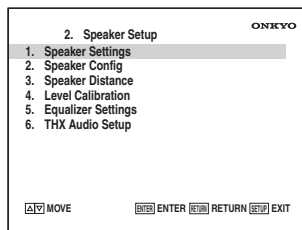
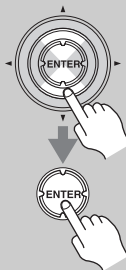

5

Use the Up and Down [▲]/[▼] buttons to select “3. Speaker Distance”, and then press [ENTER].
The “Speaker Distance” screen appears.

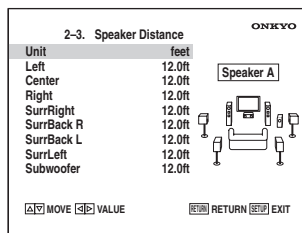
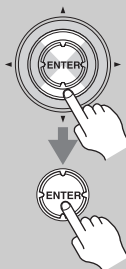

Note:

Speakers that you set to “No” or “None” in the Speaker Configuration (page 95) cannot be selected.

6

Use the Up and Down [▲]/[▼] buttons to select “Unit”, and then use the Left and Right [◀]/[▶] buttons to select:

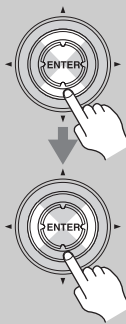

feet: Select if you want to enter distances in feet. Can be set from 0.5 to 30 feet in 0.5-foot steps.

meters: Select if you want to enter distances in meters. Can be set from 0.15 to 9 meters in 0.15-meter steps.

7	<p>Use the Up and Down [▲]/[▼] buttons to select a speaker, and use the Left and Right [◀]/[▶] buttons to specify the distance.</p> <p>Specify the distance from the speaker to your listening position.</p> <p>Notes:</p> <ul style="list-style-type: none"> You can specify different distances for front Speakers A and front Speakers B, but not the other speakers (i.e., subwoofer, center, surround, and surround back). The “Center” distance cannot be set if the “Center” is set to “None” (page 95) or “Not Use” (page 98). The “SurrRight” and “SurrLeft” distances cannot be set if the “Surround” is set to “None” (page 95) or “Not Use” (page 98). The “SurrBack R” and “SurrBack L” distances cannot be set if “Speaker Type: Front(Speaker A) or Front(Speaker B)” is set to “Bi-Amp” or “BTL” (page 61), “SurrBack” is set to “None” (page 95) or “Not Use” (page 98), or “Powered Zone2” is being used (page 132). The “Subwoofer” distance cannot be set if “Subwoofer” is set to “No” (page 96).
8	<p>Repeat step 7 for each speaker.</p>
9	<p>Press the [SETUP] button.</p> <p>Setup closes.</p>

Note:
This procedure can also be performed on the AV receiver by using its [SETUP] button, arrow buttons, and [ENTER] button.

Speaker Level Calibration

These settings are set automatically by the Automatic Speaker Setup function (see page 64).

With the “Level Calibration” settings, you can adjust the level of each speaker while listening to the test tone so that the volume of each speaker is the same at the listening position. You can adjust the levels of front Speakers A and front Speakers B independently. The other speakers (i.e., subwoofer, center, surround, and surround back) use the same level settings for Speakers A and Speakers B.

- Notes:**
- The speakers cannot be calibrated while the output of the AV receiver is muted.
 - The test tone is output at the standard level for THX, which is 0 dB (absolute volume setting 82). If you normally listen at volume settings below this, be careful because the test tone will be much louder.

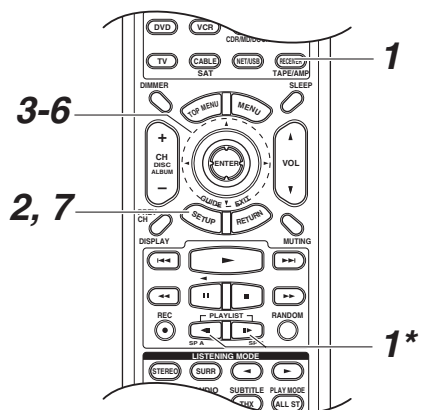

*TX-NR906 only

1	<p>Press the [RECEIVER] REMOTE MODE button, and then use the remote controller's [SP A] or [SP B] button to select Speakers A or Speakers B, respectively (TX-NR906 only).</p> <p>Notes:</p> <ul style="list-style-type: none"> Speakers B cannot be selected if “Speaker Type: Front(Speaker B)” is set to “Not Use”. TX-SR876 continue with step 2 after press the [RECEIVER] REMOTE MODE button.
2	<p>Press the [SETUP] button.</p> <p>The main menu appears onscreen.</p>

3

Use the Up and Down [▲]/[▼] buttons to select “2. Speaker Setup”, and then press [ENTER].

The “Speaker Setup” menu appears.

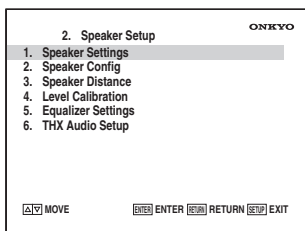
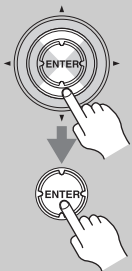

4

Use the Up and Down [▲]/[▼] buttons to select “4. Level Calibration”, and then press [ENTER].

The “Level Calibration” screen appears and the pink noise test tone is output by the front left speaker.

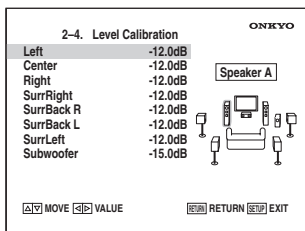
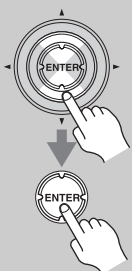

Note:

Levels cannot be adjusted for speakers set to “No” or “None” in the Speaker Configuration (page 95).

5

Use the Up and Down [▲]/[▼] buttons to select a speaker, and use the Left and Right [◀]/[▶] buttons to adjust the level.

Levels can be adjusted from –12 to +12 dB in 0.5 dB steps (–15 to +12 dB for the subwoofer).

Notes:

- You can set different levels for front Speakers A and front Speakers B, but not the other speakers (i.e., subwoofer, center, surround, and surround back).
- The “Center” level cannot be set if the “Center” is set to “None” (page 95) or “Not Use” (page 98).
- The “SurrRight” and “SurrLeft” levels cannot be set if the “Surround” is set to “None” (page 95) or “Not Use” (page 98).
- The “SurrBack R” and “SurrBack L” levels cannot be set if “Speaker Type: Front(Speaker A) or Front(Speaker B)” is set to “Bi-Amp” or “BTL” (page 61), “SurrBack” is set to “None” (page 95) or “Not Use” (page 98), or “Powered Zone2” is being used (page 132).
- The “Subwoofer” levels cannot be set if “Subwoofer” is set to “No” (page 96).

6

Repeat step 5 until the volume of the test tone from each speaker is the same.

If you’re using a handheld sound level meter, adjust the level of each speaker so that it reads 75 dB SPL at the listening position, measured with C-weighting and slow reading.

7

Press the [SETUP] button.

Setup closes.



Notes:

- Speaker levels can also be adjusted by using the dedicated buttons on the remote controller. Press the [TEST TONE] button to output the test tone. Use the [CH SEL] button to select each speaker, and use the [LEVEL–] and [LEVEL+] buttons to adjust the level.
- This procedure can also be performed on the AV receiver by using its [SETUP] button, arrow buttons, and [ENTER] button.

Equalizer Settings

These settings are set automatically by the Automatic Speaker Setup function (see page 64).

With the Equalizer settings, you can adjust the tone of speakers individually with a 7-band equalizer. The volume of each speaker can be set on page 100. The Equalizer settings only apply to Speakers A and cannot be adjusted while Speakers B is selected.

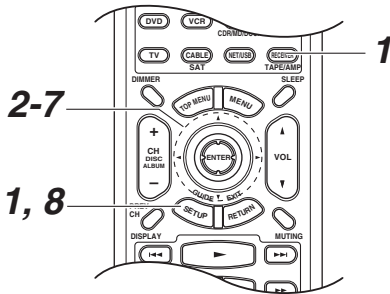

1 Press the [RECEIVER] REMOTE MODE button, followed by the [SETUP] button.

The main menu appears onscreen. If the main menu doesn't appear, make sure the appropriate external input is selected on your TV.

2 Use the Up and Down [▲]/[▼] buttons to select "2. Speaker Setup", and then press [ENTER].

The "Speaker Setup" menu appears.

2. Speaker Setup	
ONKYO	
1. Speaker Settings	
2. Speaker Config	
3. Speaker Distance	
4. Level Calibration	
5. Equalizer Settings	
6. THX Audio Setup	
[F4] MOVE [F5] ENTER [F6] RETURN [F7] EXIT	

3 Use the Up and Down [▲]/[▼] buttons to select "5. Equalizer Settings", and then press [ENTER].

The "Equalizer Settings" screen appears.

2-5. Equalizer Settings	
ONKYO	
Equalizer	Manual
Channel	Front
63Hz	0dB
160Hz	0dB
400Hz	0dB
1000Hz	0dB
2500Hz	0dB
6300Hz	0dB
16000Hz	0dB
[F4] MOVE [F5] VALUE [F6] RETURN [F7] EXIT	

4 Use the Left and Right [◀]/[▶] buttons to set the "Equalizer" option to:

- ➔ **Off:** Equalizer off, flat response.
- ↕
- ➔ **Manual:** The equalizer for each speaker can be set manually.
- ↕
- ➔ **MultEQ XT^{*1}**
- ↕
- ➔ **Dynamic EQ^{*1}**
- ↕
- ➔ **Dynamic Vol(Light)^{*1}**
- ↕
- ➔ **Dynamic Vol(Heavy)^{*1}**

*1 These setting can be selected after having performed the Automatic Speaker Setup. As soon as the Automatic Speaker Setup is complete, it will automatically be set to Dynamic EQ™.

When "Dynamic EQ" is selected, "MultEQ[®] XT" and "Dynamic EQ" become available.

When "Dynamic Vol(Light)" or "Dynamic Vol(Heavy)" is selected, "MultEQ XT", "Dynamic EQ", and "Dynamic Volume™" become available.

If you selected "Manual", continue with the next step. If you selected "Off" go to step 8.

- MultEQ XT**

Audyssey MultEQ XT correction is active (see page 64).
- Dynamic EQ**

"Audyssey MultEQ XT" and "Dynamic EQ" becomes active (see page 64).
- Dynamic Vol(Light)**

"Audyssey MultEQ XT", "Dynamic EQ", and "Dynamic Volume (Light Compression Mode)" becomes active (see page 64).

This setting prevents loud and soft sounds from being much louder and softer respectively than average sounds.
- Dynamic Vol(Heavy)**

"Audyssey MultEQ XT", "Dynamic EQ", and "Dynamic Volume (Heavy Compression Mode)" becomes active.

This setting affects volume the most, causing all sounds to be of equal loudness.

5

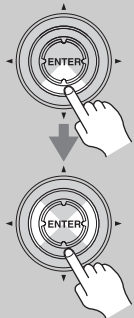

Use the Down [▼] button to select “Channel”, and then use the Left and Right [◀]/[▶] buttons to select a speaker.

You can select: “Front”, “Center”, “Surround”, “SurrBack”, or “Subwoofer”.

2-5. Equalizer Settings		ONKYO
Equalizer	Manual	
Channel	Front	
63Hz	0dB	
160Hz	0dB	
400Hz	0dB	
1000Hz	0dB	
2500Hz	0dB	
6300Hz	0dB	
16000Hz	0dB	

MOVE VALUE RETURN EXIT

- The Equalizer settings have no effect on 176.4/192 kHz input signals.
- This procedure can also be performed on the AV receiver by using its [SETUP] button, arrow buttons, and [ENTER] button.

6

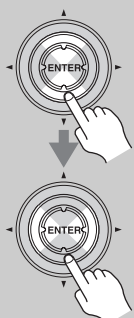

Use the Up and Down [▲]/[▼] buttons to select a frequency, and then use the Left and Right [◀]/[▶] buttons to adjust the level at that frequency.

You can select: “63Hz”, “160Hz”, “400Hz”, “1000Hz”, “2500Hz”, “6300Hz”, or “16000Hz”. And for the subwoofer, “25Hz”, “40Hz”, “63Hz”, “100Hz”, or “160Hz”.

The volume at each frequency can be adjusted from -6 to +6 dB in 1 dB steps.

Tip:

Low frequencies (e.g., 160Hz) affect bass sounds; high frequencies (e.g., 6300Hz) affect treble sounds.

7

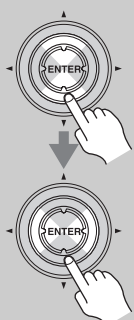

Use the Up and Down [▲]/[▼] buttons to select “Channel”, and then use the Left and Right [◀]/[▶] buttons to select another speaker.

Repeat steps 6 and 7 for each speaker.

8



Press the [SETUP] button.

The setup menu closes.

Notes:

- When the listening mode is set to Direct or Pure Audio, no effect will be produced.

THX Audio Setup

These settings are **not** set automatically by the Automatic Speaker Setup function (see page 64).

With the “SurrBack Sp Spacing” setting, you can specify the distance between your surround back speakers. This setting is used by Speakers A and Speakers B.

If you’re using a THX-certified subwoofer, set the “THX Subwoofer” setting to “Yes”. You can then apply THX’s Boundary Gain Compensation (BGC) to compensate the perceived exaggeration of low frequencies for listeners sitting very close to a room boundary (i.e., wall).

You can also set the THX Loudness Plus feature “On” or “Off”. When the “Loudness Plus” is set to “On”, it is possible to enjoy even subtle nuances of audio expression at low volume.

This result is only available when the THX listening mode is selected.



1 Press the [RECEIVER] REMOTE MODE button, followed by the [SETUP] button.

The main menu appears onscreen.

If the main menu doesn’t appear, make sure the appropriate external input is selected on your TV.

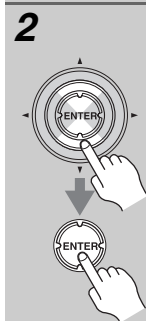

2 Use the Up and Down [▲]/[▼] buttons to select “2. Speaker Setup”, and then press [ENTER].

The “Speaker Setup” menu appears.

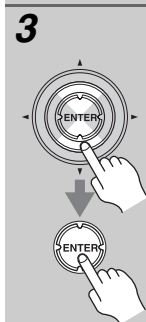
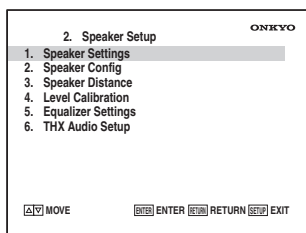

3 Use the Up and Down [▲]/[▼] buttons to select “6. THX Audio Setup”, and then press [ENTER].

The “THX Audio Setup” screen appears.

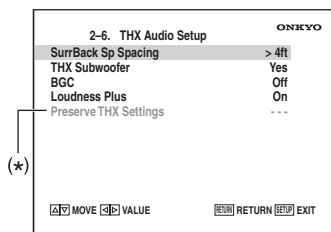

When “Loudness Plus” is set to “Off”, the “Preserve THX settings” can be selected.

4



Use the Up and Down [▲]/[▼] buttons to select “SurrBack Sp Spacing”, and use the Left and Right [◀]/[▶] buttons to specify the distance between your surround back speakers:

> 4ft (>1.2m) (Default): Select this if your surround back speakers are more than 4 feet (1.2 m) apart.

< 1ft (< 0.3m): Select this if your surround back speakers are between 0 and 1 foot (0–30 cm) apart.

1ft– 4ft (0.3m–1.2m): Select this if your surround back speakers are between 1 and 4 feet (0.3–1.2 m) apart.

Note:

Cannot be set if “SurrBack Ch” is set to “2ch” (page 96), “Speaker Type: Front(Speaker A) or Front(Speaker B)” is set to “Bi-Amp” or “BTL” (page 61), “SurrBack” is set to “None” (page 96) or “Not Use” (page 98), or “Powered Zone2” is being used (page 132).

5



Use the Up and Down [▲]/[▼] buttons to select “THX Subwoofer”, and use the Left and Right [◀]/[▶] buttons to select:

No: Select this if you do not have a THX-certified subwoofer.

Yes: Select this if you have a THX-certified subwoofer.

6



Use the Up and Down [▲]/[▼] buttons to select “BGC”, and use the Left and Right [◀]/[▶] buttons to select:

Off: Select this to turn off BGC.

On: Select this to turn on BGC.

Note:

This setting is only available if “THX Subwoofer” is set to “Yes” (step 5).

7

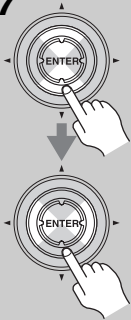

Use the Up and Down [▲]/[▼] buttons to select “Loudness Plus”, and use the Left and Right [◀]/[▶] buttons to select:

Off: Select this to turn off Loudness Plus.

On: Select this to turn on Loudness Plus (default).

When “Loudness Plus” is set to “Off”, the “Preserve THX settings” selection will appear under “Loudness Plus” (Step 8).

8

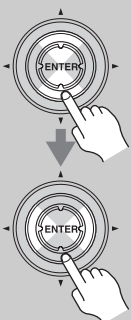

Use the Up and Down [▲]/[▼] buttons to select “Preserve THX settings”, and use the Left and Right [◀]/[▶] buttons to select:

Yes: When Yes is selected, Audyssey Dynamic EQ™ / Audyssey Dynamic Volume™ will not be active.

No: When No is selected, Audyssey Dynamic EQ / Audyssey Dynamic Volume will be active in THX listening mode depending on the setting.

Note:

This setting is only available if “Loudness Plus” is set to “Off” (step 7).

9



Press the [SETUP] button.

The setup menu closes.

Note:

This procedure can also be performed on the AV receiver by using its [SETUP] button, arrow buttons, and [ENTER] button.

THX Loudness Plus

THX Loudness Plus is a new volume control technology featured in THX Ultra2 Plus™ and THX Select2 Plus™ Certified receivers. With THX Loudness Plus, home theater audiences can now experience the rich details in a surround mix at any volume level. A consequence of turning the volume below Reference Level is that certain sound elements can be lost or perceived differently by the listener. THX Loudness Plus compensates for the tonal and spatial shifts that occur when the volume is reduced by intelligently adjusting ambient surround channel levels and frequency response. This enables users to experience the true impact of soundtracks regardless of the volume setting. THX Loudness Plus is automatically applied when listening in any THX listening mode. The new THX Cinema, THX Music, and THX Games modes are tailored to apply the proper THX Loudness Plus settings for each type of content.

Audio Adjust

Here you can set listening mode-related settings and functions.

1



Press the [RECEIVER] REMOTE MODE button, followed by the [SETUP] button.

The main menu appears onscreen.

If the main menu doesn't appear, make sure the appropriate external input is selected on your TV.

2



Use the Up and Down [▲]/[▼] buttons to select “3. Audio Adjust”, and then press [ENTER].

The “Audio Adjust” menu appears.

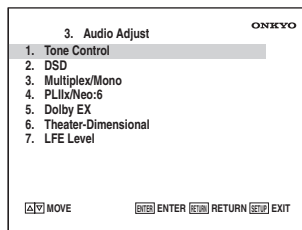

3



Use the Up and Down [▲]/[▼] buttons to select an item, and then press [ENTER].

The function menu you selected appears.

4



Use the Up and Down [▲]/[▼] buttons to select the settings, and use the Left and Right [◀]/[▶] buttons to set them.

The settings are explained below.

5



When you've finished, press the [SETUP] button.

The setup menu closes.

Note:

This procedure can also be performed on the AV receiver by using its [SETUP] button, arrow buttons, and [ENTER] button.

Tone Control Settings

You can adjust the tone (bass and treble) of the front, center, surround, and surround back speakers individually. For the subwoofer, you can adjust the bass.

■ **Bass**

You can boost or cut low-frequency sounds from -10 dB to +10 dB in 1 dB steps.

■ **Treble**

You can boost or cut high-frequency sounds from -10 dB to +10 dB in 1 dB steps.

Notes:

- The tone control circuits are bypassed when the Direct, Pure Audio or THX listening mode is selected.
- This setting is not available when the multichannel Analog input is selected.
- This procedure can also be performed on the AV receiver by using its [TONE], [◀], and [▶] buttons (see page 72).

DSD Setting

■ **DAC Direct**

This setting determines whether or not DSD (SACD) audio signals are passed through the DSP for A/V Sync, delay, etc., processing when the Pure Audio or Direct listening mode is selected.

No: DSD signals are processed by the DSP (default).

Yes: DSD signals are not processed by the DSP.

Multiplex/Mono Settings

Multiplex

■ **Input Ch(Mux)**

This setting determines which channel of a stereo multiplex source is output. Use it to select audio channels or languages with multiplex sources, multilingual TV broadcasts, and so on.

Main: The main channel is output (default).

Sub: The sub channel is output.

Main/Sub: Both the main and sub channels are output.

Mono

■ **Input Ch(Mono)**

This setting specifies the channel to be used for playing any 2-channel digital source such as Dolby Digital, or 2-channel analog/PCM source in the Mono listening mode.

L+R: Both the left and right channels are output (default).

L: Only the left channel is output.

R: Only the right channel is output.

■ **Output Speaker**

This setting determines which speakers output mono audio when the Mono listening mode is selected.

C: Mono audio is output by the center speaker (default).

L/R: Mono audio is output by the front left and right speakers.

PLIIx/Neo:6 Settings

PLIIx Music(2ch Input)

These settings apply to only 2-channel stereo sources.

If you're not using any surround back speakers, these settings apply to Dolby Pro Logic II, not Dolby Pro Logic IIx.

■ **Panorama**

With this setting, you can broaden the width of the front stereo image when using the Dolby Pro Logic IIx Music listening mode.

On: Panorama function on.

Off: Panorama function off (default).

■ Dimension

With this setting, you can move the sound field forward or backward when using the Dolby Pro Logic Ix Music listening mode. It can be adjusted from -3 to $+3$. The default value is 0 . Lower settings move the sound field forward. Higher settings move it backward.

If the stereo image feels too wide, or there's too much surround sound, move the sound field forward to improve the balance. Conversely, if the stereo image feels like it's in mono, or there's not enough surround sound, move it backward.

■ Center Width

With this setting, you can adjust the width of the sound from the center speaker when using the Dolby Pro Logic Ix Music listening mode. Normally, if you're using a center speaker, the center channel sound is output by only the center speaker. (If you're not using a center speaker, the center channel sound will be distributed to the front left and right speakers to create a phantom center). This setting controls the front left, right, and center mix, allowing you to adjust the weight of the center channel sound. It can be adjusted from 0 to 7 . The default value is 3 .

Neo:6 Music

■ Center Image

The DTS Neo:6 Music listening mode creates 6-channel surround sound from 2-channel stereo sources. With this setting, you can specify by how much the front left and right channel output is attenuated in order to create the center channel. It can be adjusted from 0 to 5 . The default value is 2 .

When set to 0 , the front left and right channel output is attenuated by half (-6 dB), giving the impression that the sound is located centrally. This setting works well when the listening position is considerably off center. When set to 5 , the front left and right channels are not attenuated, maintaining the original stereo balance.

Dolby EX Settings

■ Dolby EX

This setting determines how Dolby EX signals are handled.

Auto: When the source is Dolby EX, you can select the Dolby EX or THX Surround EX listening mode (default).

Manual: When the source is Dolby EX, you can select any of the listening modes compatible with this format (e.g., Dolby EX, Dolby Pro Logic Ix, etc.).

Theater-Dimensional (T-D) Setting

■ Listening Angle

With this setting, you can optimize the Theater-Dimensional listening mode by specifying the angle of the front left and right speakers relative to the listening position. Ideally, the front left and right speakers should be equidistant from the listening position and at an angle close to one of the two available settings.

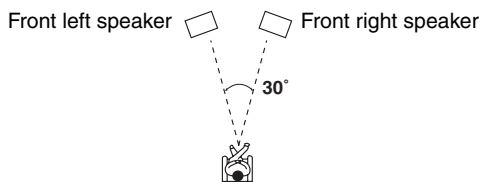

Wide: Select if the angle is greater than 30 degrees (default).

Narrow: Select if the angle is less than 30 degrees.

LFE Level Settings

With these settings, you can set the level of the LFE (Low Frequency Effects) channel individually for Dolby Digital, DTS, and multichannel PCM sources. The level can be set to $-\infty$, -20 dB, -10 dB, or 0 dB (default).

If you find that low-frequency effects are too loud when using one of these sources, change the setting to -20 dB or $-\infty$ dB.

■ Dolby Digital

Sets the level of the LFE channel for Dolby Digital and Dolby Digital Plus sources.

■ DTS

Sets the level of the LFE channel for DTS and DTS-HD High Resolution sources.

■ Multich PCM

Sets the level of the LFE channel for multichannel PCM sources. (Multichannel PCM is input via HDMI.)

■ Dolby TrueHD

Sets the level of the LFE channel for Dolby TrueHD sources.

■ DTS-HD Master Audio

Sets the level of the LFE channel for DTS-HD Master Audio sources.

■ DSD

Sets the level of the LFE channel for DSD sources.

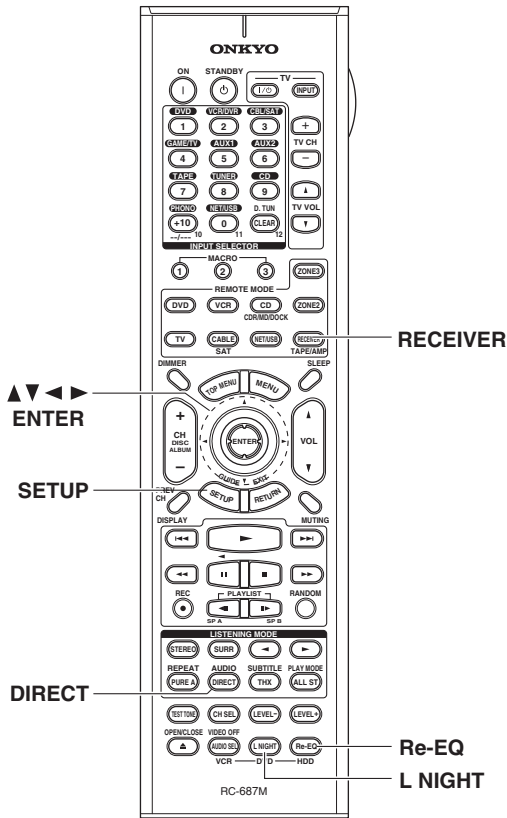

Adjust Using the Direct Button

You can change various audio settings by pressing the [DIRECT] button.

1

Remote controller

Press the [RECEIVER] REMOTE MODE button, press and hold down the [DIRECT] button.

The setting item appears on the display.

2

Use the Up and Down [▲]/[▼] buttons to select an item.

3

Use the Left and Right [◀]/[▶] buttons to change the setting.

Repeat this step for the other settings.

Music Optimizer

Optimizer

The Music Optimizer function enhances the sound quality of compressed music files. Use it with music files that use “lossy” compression, such as MP3.

- Off:** Music Optimizer off (default).
- On:** Music Optimizer on.

Note:

The Music Optimizer function only works with PCM digital audio input signals with a sampling rate below 48 kHz and analog audio input signals. The Music Optimizer is disabled when the Pure Audio or Direct listening mode is selected.

Using the Re-EQ Function

With the Re-EQ function, you can compensate a soundtrack whose high-frequency content is too harsh, making it more suitable for home theater viewing.

This function can be used with the following listening modes: Dolby Digital, Dolby Digital EX, Dolby Pro Logic II Movie, Dolby Pro Logic IIx Movie, DTS, DTS-ES, DTS Neo:6 Cinema, DTS 96/24, THX Cinema, THX Surround EX, THX Ultra2 Cinema, Neural THX, and Multichannel.

Press the [RECEIVER] REMOTE MODE button, followed by the [Re-EQ] button.

Press the [Re-EQ] button again to turn off the Re-EQ function.

Using the Late Night Function

With the Late Night function, you can reduce the dynamic range of Dolby Digital material so that you can still hear quiet parts even when listening at low volume levels—ideal for watching movies late at night when you don't want to disturb anyone.



Press the **[RECEIVER] REMOTE MODE** button, and then press the **[L NIGHT]** button repeatedly.

For Dolby Digital and Dolby Digital Plus sources, the options are:

- Off:** Late Night function off (default).
- Low:** Small reduction in dynamic range.
- High:** Large reduction in dynamic range.

For Dolby TrueHD sources, the options are:

- Auto:** The dynamic range is controlled automatically based on the source material and the current volume setting (default).
- Off:** Late Night function off.
- On:** Late Night function on.

Notes:

- The Late Night function can be used only when the input source is Dolby Digital, Dolby Digital Plus, or Dolby TrueHD.
- The effect of the Late Night function depends on the material that you are playing and the intention of the original sound designer, and with some material there will be little or no effect when you select the different options.
- The Late Night function is set to “Off” when the AV receiver is set to Standby. For Dolby TrueHD sources, it will be set to “Auto”.

Source Setup

This section explains items on the “Source Setup” menu. Items can be set individually for each input selector.

1



Press the **[RECEIVER] REMOTE MODE** button, and then use the input selector buttons to select an input source.

2



Press the **[SETUP]** button. The main menu appears onscreen.

3

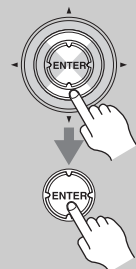

Use the Up and Down **[▲]/[▼]** buttons to select “4. Source Setup”, and then press **[ENTER]**.

The “Source Setup” menu appears. The name of the currently selected input selector is displayed in a box.

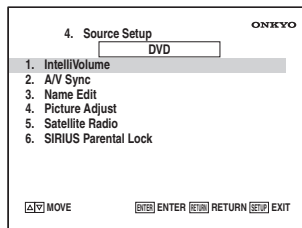

4

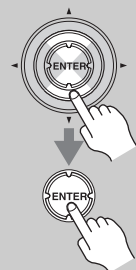

Use the Up and Down **[▲]/[▼]** buttons to select an item, and then press **[ENTER]**.

The screen for that item appears.

5

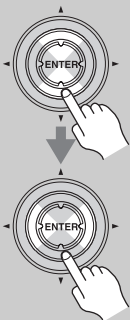

Use the Up and Down [▲]/[▼] buttons to select an option, and use the Left and Right [◀]/[▶] buttons to change it.

The “Source Setup” menu items are explained below.

6



When you’ve finished, press the [SETUP] button.

Setup closes.

IntelliVolume

With IntelliVolume, you can set the input level for each input selector individually. This is useful if one of your source components is louder or quieter than the others.

Use the Left and Right [◀]/[▶] buttons to set the level.

If a component is noticeably louder than the others, use the Left [◀] button to reduce its input level. If it’s noticeably quieter, use the Right [▶] button to increase its input level. The input level can be adjusted from –12 dB to +12 dB in 1 dB steps.

Note:

IntelliVolume does not apply for Zone 2 or Zone 3.

A/V Sync

When using your DVD player’s progressive scanning function, you may find that the picture and sound are out of sync. With the “A/V Sync” setting, you can correct this by applying a delay to the audio signal. The delay can be set from 0 to 250 milliseconds (msec) in 5 millisecond steps.

Use the Up and Down [▲]/[▼] buttons to select an input selector, and use the Left and Right [◀]/[▶] buttons to set the delay.

To view the TV picture while setting the delay, press [ENTER].

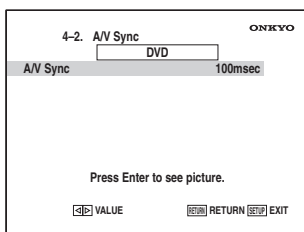

If HDMI Lip Sync is enabled (see page 118), and your TV or display supports HDMI Lip Sync, the displayed delay time will be the A/V Sync delay time. The HDMI Lip Sync delay time is displayed underneath in parentheses.

Note:

A/V Sync cannot be set when the Pure Audio listening mode is selected, or when the Direct listening mode is used with an analog input source.

Name Edit

You can enter a custom name for each individual input selector and radio preset for easy identification. When entered, the custom name will appear on the display.

The custom name is edited using the character input screen.

1. Use the arrow [▲]/[▼]/[◀]/[▶] buttons to select a character, and then press [ENTER].
Repeat this step to enter up to 10 characters.
2. When you’ve finished, to store a name, be sure to use the arrow [▲]/[▼]/[◀]/[▶] buttons to select “OK”, and then press [ENTER]. Otherwise it will not be saved.

Name input area

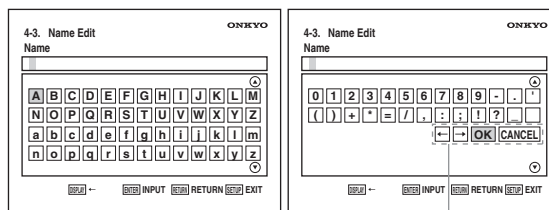

← (Left)/ → (Right):

Selected when the cursor is moved within the Name input area.

OK:

Selects when the entry is complete.

CANCEL:

Selects when you want to cancel the name entry.

To correct a character:

1. Use the arrow [▲]/[▼]/[◀]/[▶] buttons to select “←”(Left) or “→”(Right) and then press [ENTER].
2. Press [ENTER] several times to select the incorrect character (The cursor moves one letter each time [ENTER] is pressed).
3. Use the arrow [▲]/[▼]/[◀]/[▶] buttons to select the correct character, and then press [ENTER].

Notes:

- To name a radio preset, use the [TUNER] button to select AM or FM, and then select the preset (see step 1 on page 109).
- You cannot enter a custom name for XM or SIRIUS radio presets.
- To restore a custom name to the default, erase the custom name by entering an empty white space for each letter.
- This procedure can also be performed on the AV receiver by using its [SETUP], [ENTER], and arrow buttons.

Picture Adjust

The new “4-4. Picture Adjust” item has been added to the “1. Input/Output Assign” menu. This menu and its settings can be accessed just like the other menus. The settings are explained below.

■ Game Mode

If video signal delay occurs during play on a video component, such as a Game console, connected to the AV receiver, select “Game Mode” on the input selector connected to the component and set it to “On”.

Use the Left and Right [◀]/[▶] buttons to select:

Off: Game Mode off (default).

On: Game Mode on.

■ Zoom Mode

This setting determines the aspect ratio.

Normal:

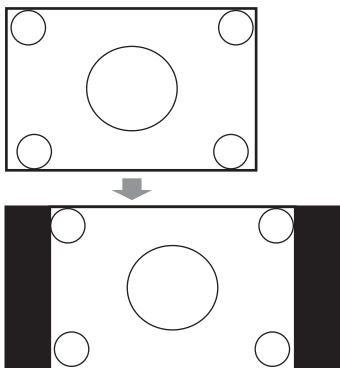

Full: (default)

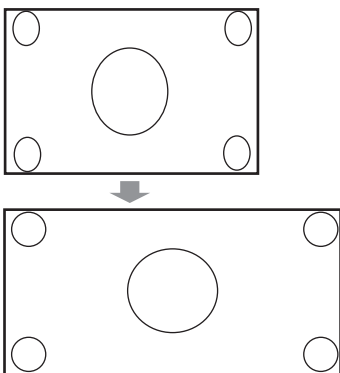

Zoom:

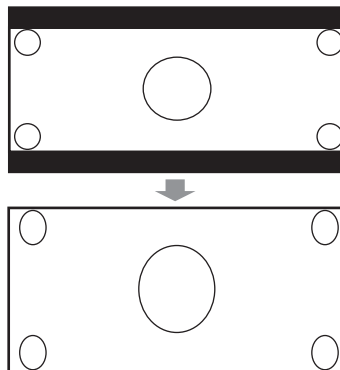

WideZoom:

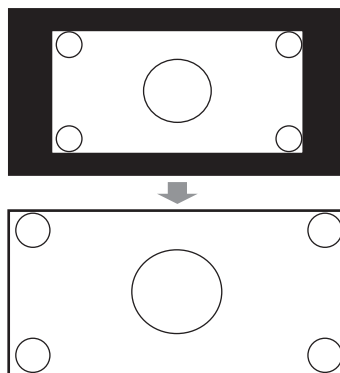

Note:

The “Zoom Mode” can also be set using the [DISPLAY] button on the remote controller.

1. Press and hold the [DISPLAY] button until the setting item appears on the display.
2. Use the Up and Down [▲]/[▼] buttons to select “Zoom Mode”, and use the Left and Right [◀]/[▶] buttons to change the setting.

■ ISF Mode

The receiver has been designed to incorporate setup and calibration standards established by the Imaging Science Foundation (ISF). The ISF has developed carefully crafted, industry-recognized standards for optimal video performance and has implemented a training program for technicians and installers to use these standards to obtain optimal picture quality from the receiver. Accordingly, Onkyo recommends that setup and calibration be performed by an ISF Certified installation technician.

Custom: User setting (All items can be freely set.)

Day: Setting when a room is bright.

Night: Setting when a room is dark.

Note:

When “ISF Mode” is selected, the setting from “Resolution” to “B Contrast” is changed.

Resolution

You can specify the output resolution for the HDMI outputs and have the AV receiver upconvert the picture resolution as necessary to match the resolution supported by your TV.

Available only when Source has been selected under the “1-1. Monitor Out” setting.

Through: Select this to pass video through the AV receiver at the same resolution and with no conversion (default).

Auto: Select this to have the AV receiver automatically convert video at resolutions not supported by your TV.
When the “Monitor Out” is set to “Analog”, it will operate as “Through”.

480p (480/576p):
Select this for 480p or 576p output and video conversion as necessary.

720p: Select this for 720p output and video conversion as necessary.

1080i: Select this for 1080i output and video conversion as necessary.

1080p: Select this for 1080p output and video conversion as necessary.
When the “Monitor Out” is set to “Analog”, it will operate as “1080i”.

Source: Output will be according to the resolution level which was set with Resolution inside Source: 4-4. Picture Adjust. (Setting for each Source becomes possible.)

Brightness

With this setting you can adjust the picture brightness. Can be adjusted from -50 to +50 in steps of 1 (default is 0).

“-50” is the darkest.

“+50” is the brightest.

Contrast

With this setting you can adjust Contrast. Can be adjusted from -50 to +50 in steps of 1 (default is 0).

“-50” is the least.

“+50” is the greatest.

Hue

With this setting you can adjust the red/green balance. Can be adjusted from -20 to +20 in steps of 1 (default is 0).

“-20” is the strongest green.

“+20” is the strongest red.

Saturation

With this setting you can adjust saturation. Can be adjusted from -50 to +50 in steps of 1 (default is 0).

“-50” is the weakest color.

“+50” is the strongest color.

Picture Mode

DVD-Video disc content originates from either film (recorded at 24 frames per second) or video intended for TV (recorded at 30 frames per second). With the default Picture Mode setting of Auto, the AV receiver automatically detects the type of content and processes it accordingly to achieve the best picture quality. If the AV receiver detects the type of content incorrectly due to characteristics of the disc, you can select Video or Film manually.

Auto: The type of content is detected automatically and processed accordingly (default).

Video: Select when playing a DVD-Video disc whose content originates from video.

Film: Select when playing a DVD-Video disc whose content originates from film.

Edge Enhancement

With Edge Enhancement, you can make the picture appear sharper.

Off: Edge enhancement off (default).

Low: Low edge enhancement.

Medium: Medium edge enhancement.

High: High edge enhancement.

Mosquito NR

With Mosquito Noise Reduction, you can remove the shimmering or haziness that sometimes appears around objects in the picture. Mosquito noise can be an issue with overly compressed MPEG content.

Off: Mosquito noise reduction off (default).

Low: Low mosquito noise reduction.

Medium: Medium mosquito noise reduction.

High: High mosquito noise reduction.

Random NR

With Random Noise Reduction, you can remove indiscriminate picture noise, such as film grain.

Off: Random noise reduction off (default).

Low: Low random noise reduction.

Medium: Medium random noise reduction.

High: High random noise reduction.

Block NR

With Block Noise Reduction, you can remove the block distortion that sometimes appears in the picture. Block noise can be an issue with overly compressed MPEG content.

Off: Block noise reduction off (default).

On: Block noise reduction on.

Gamma

Adjust the balance of incoming picture R (red), G (green), and B (blue) color data signal to the output color data signal.

Can be adjusted from -3 to +3 in steps of 1 (default is 0).

R Brightness:

With this setting you can adjust the picture red brightness.

Can be adjusted from -50 to +50 in steps of 1 (default is 0).

“-50” is the darkest.

“+50” is the brightest.

R Contrast:

With this setting you can adjust red Contrast.

Can be adjusted from -50 to +50 in steps of 1 (default is 0).

“-50” is the least.

“+50” is the greatest.

G Brightness:

With this setting you can adjust the picture green brightness.

Can be adjusted from -50 to +50 in steps of 1 (default is 0).

“-50” is the darkest.

“+50” is the brightest.

G Contrast:

With this setting you can adjust green Contrast.

Can be adjusted from -50 to +50 in steps of 1 (default is 0).

“-50” is the least.

“+50” is the greatest.

B Brightness:

With this setting you can adjust the picture blue brightness.

Can be adjusted from -50 to +50 in steps of 1 (default is 0).

“-50” is the darkest.

“+50” is the brightest.

B Contrast:

With this setting you can adjust blue Contrast.

Can be adjusted from -50 to +50 in steps of 1 (default is 0).

“-50” is the least.

“+50” is the greatest.

Satellite Radio

This item is for use with satellite radio. It's not available if “Satellite Radio” is set to None (see page 118). See the separate Satellite Radio Guide for more information.

SIRIUS Parental Lock

This item is for use with SIRIUS Satellite Radio. It's not available if “Satellite Radio” is set to None or XM (see page 118). See the separate Satellite Radio Guide for more information.

Listening Mode Presets

On the “Listening Mode Preset” menu, you can specify a default listening mode for each of the audio formats supported by each input selector. The AV receiver will then select the listening mode automatically depending on the format of the input signal. You can still select the other listening modes, although the default listening mode will be used the next time you turn on the AV receiver.

1



Press the [RECEIVER] REMOTE MODE button, followed by the [SETUP] button.

The main menu appears onscreen. If the main menu doesn't appear, make sure the appropriate external input is selected on your TV.

2

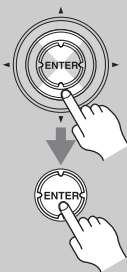

Use the Up and Down [▲]/[▼] buttons to select “5. Listening Mode Preset”, and then press [ENTER].

The “Listening Mode Preset” menu appears.

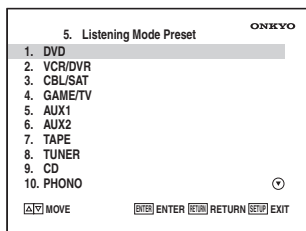

3



Use the Up and Down [▲]/[▼] buttons to select an input selector, and then press [ENTER].

The audio formats supported by that input selector appear.

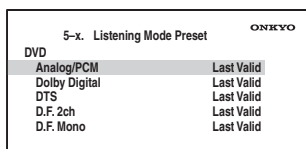

If the input selector is assigned to an HDMI IN, use the Down [▼] button to select the audio formats shown on the following screen.

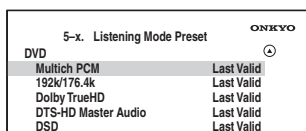

For the “TUNER” input selector, “Analog” is the only format available.

4

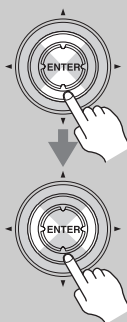

Use the Up and Down [▲]/[▼] buttons to select an audio format, and use the Left and Right [◀]/[▶] buttons to select a listening mode.

Only listening modes compatible with the audio format can be selected (see page 82).

Analog/PCM: Specifies the default listening mode for analog and PCM sources.

Dolby Digital: Specifies the default listening mode for Dolby Digital and Dolby Digital plus sources.

DTS: Specifies the default listening mode for DTS and DTS-HD High Resolution sources.

D.F. 2ch: Specifies the default listening mode for 2-channel (2/0) stereo sources in a digital format, such as Dolby Digital or DTS.

D.F. Mono: Specifies the default listening mode for mono sources in a digital format, such as Dolby Digital or DTS.

Multichannel PCM: Specifies the default listening mode for multichannel PCM sources, such as DVD-Audio.

192k/176.4k: Specifies the default listening mode for high resolution 192 kHz and 176.4 kHz digital sources, such as DVD-Audio. (input via HDMI)

Dolby TrueHD: Specifies the default listening mode for Dolby TrueHD sources, such as Blu-ray or HD DVD (input via HDMI).

DTS-HD Master Audio: Specifies the default listening mode for DTS-HD Master Audio sources, such as Blu-ray or HD DVD (input via HDMI).

DSD: Specifies the default listening mode for DSD multichannel sources, such as SACD (input via HDMI).

5



When you've finished, press the [SETUP] button.

Setup closes.

Note:

This procedure can also be performed on the AV receiver by using its [SETUP] button, arrow buttons, and [ENTER] button.

Miscellaneous Setup

This section explains items on the “Miscellaneous” menu.

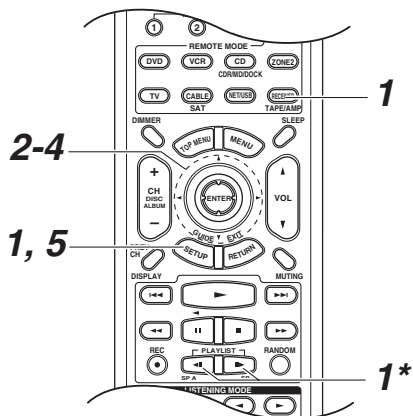

4 Use the Up and Down [▲]/[▼] buttons to select an item, and use the Left and Right [◀]/[▶] buttons to change it.

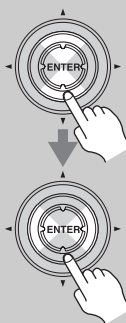

The items are explained below.

5 When you've finished, press the [SETUP] button.



Setup closes.

1 Press the [RECEIVER] REMOTE MODE button, followed by the [SETUP] button.



The main menu appears onscreen.

If the main menu doesn't appear, make sure the appropriate external input is selected on your TV.

2 Use the Up and Down [▲]/[▼] buttons to select “6. Miscellaneous”, and then press [ENTER].

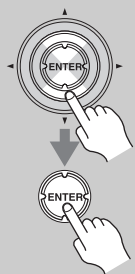

The “Miscellaneous” menu appears.

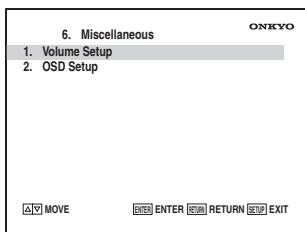

3 Use the Up and Down [▲]/[▼] buttons to select an item, and then press [ENTER].

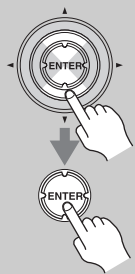

The screen for that item appears.

Note:

This procedure can also be performed on the AV receiver by using its [SETUP] button, arrow buttons, and [ENTER] button.

Volume Setup

■ Volume Display

With this setting, you can choose how the volume level is displayed.

Absolute: Display range is “Min”, 0.5 through 99.5, “Max”.

Relative: Display range is $-\infty$ dB, -81.5 dB through $+18.0$ dB.

The absolute value 82 is equivalent to the relative value 0 dB.

■ Muting Level

This setting determines how much the output is muted when the Muting function is used (see page 71). It can be set to $-\infty$ dB (fully muted) or from -50 dB to -10 dB in 10 dB steps.

■ Maximum Volume

With this setting, you can limit the maximum volume.

When the “Volume Display” setting is set to “Absolute”, the “Maximum Volume” range is “Off”, 99 to 50. When it's set to “Relative”, the range is “Off”, $+17$ dB to -32 dB. To disable this setting, select “Off”.

■ Power On Volume

This setting determines what the volume will be each time the AV receiver is turned on.

When the “Volume Display” preference is set to “Absolute”, the range is “Last”, “Min”, 1 to “Max”. When it’s set to “Relative”, the range is “Last”, $-\infty$ dB, -81 dB to $+18$ dB.

To use the same volume level as when the AV receiver was last turned off, select “Last”.

Note:

The “Power On Volume” setting cannot be set higher than the “Maximum Volume” setting.

■ Headphone Level

With this setting, you can offset the headphone volume relative to the main volume. This is useful if your headphones are too loud or too quiet at the volume setting you usually use when listening through your speakers. The headphone level can be set from -12 dB to $+12$ dB.

■ Zone2 Maximum Volume

With this setting, you can limit the maximum volume for Zone 2.

When the “Volume Display” setting is set to “Absolute”, the “Maximum Volume” range is “Off”, 99 to 50. When it’s set to “Relative”, the range is “Off”, $+17$ dB to -32 dB. To disable this setting, select “Off”.

■ Zone2 Power On Volume

This setting determines what the volume will be for Zone 2 each time the AV receiver is turned on.

When the “Volume Display” preference is set to “Absolute”, the range is “Last”, “Min”, 1 to “Max”. When it’s set to “Relative”, the range is “Last”, $-\infty$ dB, -81 dB to $+18$ dB.

To use the same volume level as when the AV receiver was last turned off, select “Last”.

■ Zone3 Maximum Volume

With this setting, you can limit the maximum volume for Zone 3.

When the “Volume Display” setting is set to “Absolute”, the “Maximum Volume” range is “Off”, 99 to 50. When it’s set to “Relative”, the range is “Off”, $+17$ dB to -32 dB. To disable this setting, select “Off”.

■ Zone3 Power On Volume

This setting determines what the volume will be for Zone 3 each time the AV receiver is turned on.

When the “Volume Display” preference is set to “Absolute”, the range is “Last”, “Min”, 1 to “Max”. When it’s set to “Relative”, the range is “Last”, $-\infty$ dB, -81 dB to $+18$ dB.

To use the same volume level as when the AV receiver was last turned off, select “Last”.

OSD Setup

■ Immediate Display

This setting determines whether operation details are displayed onscreen immediately after an AV receiver function is used.

On: Displayed (default).

Off: Not displayed.

Even when “On” is selected, operation details may not be output if the input source is connected to a COMPONENT VIDEO IN or HDMI IN.

For optimal video performance, THX recommends that “Immediate Display” be turned off.

■ Monitor Type

With this setting, you can specify the aspect ratio of your TV so that menus are displayed properly.

4:3: Select if your TV is 4:3.

16:9: Select if your TV is 16:9 (default).

■ Display Position

This setting determines where on the screen operation details are displayed.

Bottom: Bottom of the screen (default).

Top: Top of the screen.

■ TV Format (not North American models)

See “TV Format Setup (not North American models)” on page 62.

■ Language

This setting determines the language used for the onscreen setup menus. You can select: English, German, French, Spanish, Italian, Dutch, Swedish, or Japanese.

Hardware Setup

This section explains items on the Hardware menu.

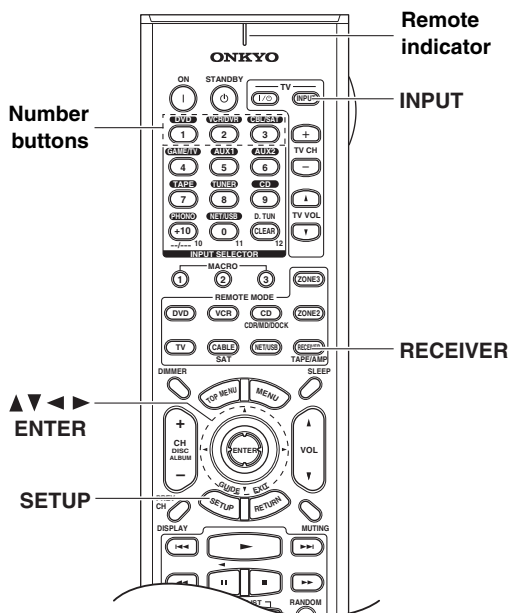

1

Press the [RECEIVER] REMOTE MODE button, followed by the [SETUP] button.

The main menu appears onscreen.

If the main menu doesn't appear, make sure the appropriate external input is selected on your TV.



2

Use the Up and Down [▲]/[▼] buttons to select "7. Hardware Setup", and then press [ENTER].

The "Hardware Setup" menu appears.

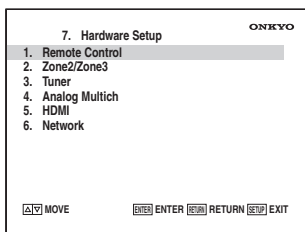
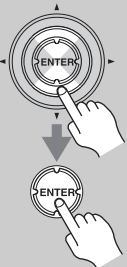

3

Use the Up and Down [▲]/[▼] buttons to select an item, and then press [ENTER].

The screen for that item appears.



4

Use the Up and Down [▲]/[▼] buttons to select an item, and use the Left and Right [◀]/[▶] buttons to change it.

The items are explained below.



5

When you've finished, press the [SETUP] button.

Setup closes.



Note:

This procedure can also be performed on the AV receiver by using its [SETUP] button, arrow buttons, and [ENTER] button.

Remote Control

Remote ID

When several Onkyo components are used in the same room, their remote ID codes may overlap. To differentiate the AV receiver from the other components, you can change its remote ID from 1, the default, to 2 or 3.

Note:

If you do change the AV receiver's remote ID, be sure to change the remote controller to the same ID (see below), otherwise, you won't be able to control it with the remote controller.

Changing the Remote Controller's ID

1

While holding down the [RECEIVER] REMOTE MODE button, press the TV [INPUT] button.

The Remote indicator flashes four times.



2

Use the number buttons to enter ID 1, 2, or 3.

The Remote indicator flashes twice.

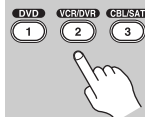

Zone2/Zone3

See "Zone 2 and Zone 3" on page 130.

Tuner

■ AM Freq Step (on some models)

See “AM Frequency Step Setup (on some models)” on page 63.

■ Satellite Radio (on North American model)

If you connect an XM Satellite Radio antenna or SIRIUS Satellite Radio antenna to the AV receiver (both sold separately), set this setting to XM or SIRIUS respectively. If you connect both types of antenna, select XM/SIRIUS. Otherwise, select None. See the separate Satellite Radio Guide for more information.

Analog Multich

■ Subwoofer Input Sensitivity

Some DVD players output the LFE channel from their analog subwoofer output at 15 dB higher than normal. With this setting, you can change the AV receiver’s subwoofer sensitivity to match your DVD player. Note that this setting only affects signals connected to the AV receiver’s MULTI CH: SUBWOOFER jack.

You can select 0 dB, 5 dB, 10 dB, or 15 dB.

If you find that your subwoofer is too loud, try the 10 dB or 15 dB setting.

HDMI

■ Audio TV Out

This setting determines whether audio received by an HDMI input is output by the HDMI outputs. You may want to change this setting to “On” if your TV is connected to an HDMI output and you want to listen to audio from an HDMI component through your TV’s speakers. Normally, it should be set to “Off”.

Off: HDMI audio is not output (default).

On: HDMI audio is output.

Notes:

- If “On” is selected and the signal can be output by the TV, the AV receiver will output no sound through its speakers.
- When “TV Control” is enabled, this setting is set to “Auto”.
- With some TVs and input signals, no sound may be output even if “On” is selected.
- When the “Audio TV Out” setting is set to “On”, or “TV Control” is set to “Enable” and you’re listening through your TV’s speakers (see page 43), if you turn up the AV receiver’s volume control, the sound will be output by the AV receiver’s speakers. To stop the AV receiver’s speakers producing sound, change the settings, change your TV’s settings, or turn down the AV receiver’s volume.

■ Lip Sync

The Lip Sync function can automatically synchronize HDMI audio and video that’s gotten out of sync due to the complex digital video processing being performed by your HDMI-compatible TV. With HDMI Lip Sync, the audio delay required to synchronize the audio and video is calculated and applied automatically by the AV receiver.

Disable: HDMI lip sync disabled (default).

Enable: HDMI lip sync enabled.

Notes:

- This function works only if your HDMI-compatible TV supports HDMI Lip Sync.
- You can check the amount of delay being applied by the HDMI Lip Sync function on the “A/V Sync” screen (see page 110).

■ x.v.Color

If your HDMI source and HDMI-compatible TV both support the “x.v.Color”, you can enable “x.v.Color” on the AV receiver with this setting.

Disable: “x.v.Color” disabled (default).

Enable: “x.v.Color” enabled.

Notes:

- If the color is unnatural when “x.v.Color” is set to “Enable”, change the setting to “Disable”.
- Refer to the connected component’s instruction manual for details.

■ Control

This function allows **RiHD**-compatible components connected via HDMI to be controlled with the AV receiver.

Disable: **RiHD** disabled (default).

Enable: **RiHD** enabled.

Notes:

- **RiHD**, which stands for Remote Interactive over HDMI, is the name of the system control function found on Onkyo components. The AV receiver can be used with CEC (Consumer Electronics Control), which allows system control over HDMI and is part of the HDMI standard. CEC provides interoperability between various components, however, operation with components other than **RiHD**-compatible components cannot be guaranteed.
- Set to “Disable” when a connected piece of equipment is not compatible or it is unclear whether the equipment is compatible or not.
- If movement is unnatural when set to “Enable”, change the setting to “Disable”.
- Refer to the connected component’s instruction manual for details.

Advanced Setup—Continued

Power Control

To link the power functions of **RIHD**-compatible components connected via HDMI, select “Enable”.

Disable: Power Control disabled.

Enable: Power Control enabled.

Notes:

- The “Power Control” setting can be set only when the above “Control” setting is set to “Enable”.
- HDMI power control only works with **RIHD**-compatible components that support it and may not work properly with some components due to their settings or compatibility.
- When set to “Enable”, power consumption will increase.
- Refer to the connected component’s instruction manual for details.

TV Control

Set to “Enable” when you want to control the AV receiver from an **RIHD**-compatible TV that is connected to HDMI.

Disable: TV Control disabled.

Enable: TV Control enabled.

Notes:

- Set to “Disable” when the TV is not compatible or when it is unclear whether the TV is compatible or not.
- The “TV Control” setting can be set only when the above “Control” and “Power Control” settings are both set to “Enable”.
- Refer to the connected component’s instruction manual for details.

Note:

After changing the settings of the “Control”, “Power Control”, or “TV Control”, turn off the power to all connected pieces of equipment and then turn on again. Refer to the User’s Manuals for all connected pieces of equipment.

When linking to a TV that conforms to the CEC standard, the “Monitor Out” setting must be set to “HDMI Main”.

Lock Setup

Lock

With this setting, you can protect your settings by locking the setup menus.

Locked: Setup menus locked.

Unlocked: Setup menus unlocked (default).

When Locked is selected, only this “Lock Setup” item can be accessed.

Network

See “Network Settings” on page 128.

Selecting Audio Inputs

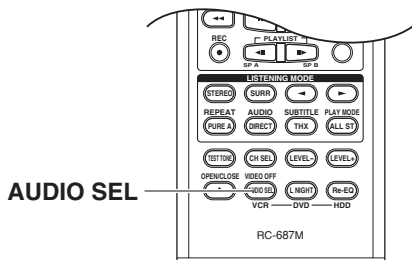

If you connect a component to more than one audio input, such as a DVD player connected to analog, digital, multichannel, and HDMI inputs, you can use the [AUDIO SEL] button to select which audio input you want to use to listen to that component.



Press the [AUDIO SEL] button repeatedly to select an audio input: HDMI > Auto > Multich > Analog.

HDMI:

Selects the assigned HDMI IN, and the HDMI indicator appears on the display. (The HDMI IN must already be assigned to the current input selector. See page 56.)

Auto:

Selects the assigned COAXIAL or OPTICAL DIGITAL IN, and the DIGITAL indicator appears on the display. (The DIGITAL IN must already be assigned to the current input selector. See page 59.) If there is no digital signal, the analog input is used instead.

Multich:

Selects the multichannel input, and the ANALOG indicator appears on the display. (The multichannel input must already be assigned to the current input selector. See page 60.)

Analog:

Selects the analog input, and the ANALOG indicator appears on the display.

Specifying the Digital Signal Format

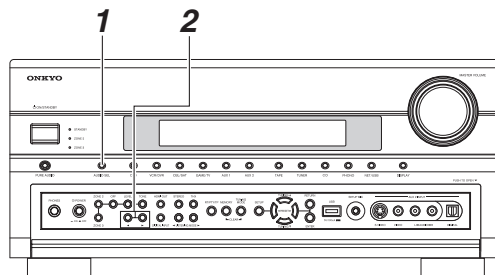

Normally, the AV receiver detects the format of digital input signals automatically. However, if you experience either of the following issues when playing PCM or DTS sources, you can specify the signal format manually.

- If the beginnings of tracks from a PCM source are cut off, try the PCM setting.
- If noise is produced when fast forwarding or rewinding a DTS CD, try the DTS setting.

1



Press the [AUDIO SEL] button repeatedly to select “Auto”.

2

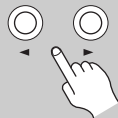

While “Auto” is shown on the display, use the Left and Right [◀]/[▶] buttons to select:

PCM:

Only 2-channel PCM format input signals will be heard. If the input signal is not PCM, the PCM indicator will flash and noise may also be produced.

DTS:

Only DTS (but not DTS-HD) format input signals will be heard. If the input signal is not DTS, the DTS indicator will flash and there will be no sound.

Auto (default):

The format is detected automatically. If no digital input signal is present, the analog input is used instead.

NET/USB (TX-NR906 only)

About NET/USB

The AV receiver is *network-ready*, which means you can hook it up to your home network with a standard Ethernet cable and enjoy the music files stored on your computer or media server. If your network is connected to the Internet, you can also enjoy Internet radio.

NET/USB can also be used to play music files stored on USB mass storage devices (e.g., USB flash drives and MP3 players), which can be plugged into the AV receiver's front panel USB port.

Internet Radio

With Internet radio you can:

- Corresponds to M3U, PLS and Podcast playlists and the streaming of the corresponding audio format noted below.
- Select stations by entering the appropriate URL with the remote controller, or connect to the AV receiver from your computer and select stations in your Web browser.
- Preset up to 20 Internet radio stations.

■ vTuner Internet Radio

- This unit includes the full vTuner Internet Radio Service at no additional charge. Once you have connected your unit to the Internet you can select vTuner Internet Radio to search for and play Internet radio stations and podcasts at any time. To enhance your Internet radio experience, the <http://onkyo.vtuner.com/> portal is available to you as an easy way to browse to find stations, set up/organize your favorites, add your own stations, get help, etc. After the first time you try Internet radio/vTuner on your unit you can use the MAC Address of your unit to create a member login account (email address and password) on the <http://onkyo.vtuner.com/> portal. To verify your MAC Address, please see Network Settings (page 128).

Supported Audio File Formats

For server and USB mass storage device playback, the AV receiver supports the following music file formats: MP3, WMA, WAV, and AAC. It also supports Microsoft's PlaysForSure technology.

■ MP3

- MP3 files must be MPEG-2 Audio Layer 3 format with a sampling rate of 32 kHz, 44.1 kHz, and 48 kHz and a bit-rate of between 32 kbps and 320 kbps. Incompatible files cannot be played.
- Variable bit-rate (VBR) MP3 files are supported. (Playing times may not display correctly.)
- MP3 files must have a ".mp3" or ".MP3" filename extension.

■ WMA

WMA stands for Windows Media Audio and is an audio compression technology developed by Microsoft Corporation. Audio can be encoded in WMA format by using Windows Media® Player.

- WMA files must have the copyright option turned off.
- Sampling rates of 32 kHz, 44.1 kHz, and 48 kHz and bitrates of between 48 kbps and 320 kbps, and lossless DRM are supported. Incompatible files cannot be played.
- Variable bit-rates (VBR) are supported. (Playing times may display incorrectly with VBR.)
- WMA files must have a ".wma" or ".WMA" filename extension.

■ WAV

WAV files contain uncompressed PCM digital audio.

- Sampling rates of 32 kHz, 44.1 kHz and 48 kHz and bitrates of 16 kbps are supported. Incompatible files cannot be played.
- WAV files must have a ".wav" or ".WAV" filename extension.

■ AAC

AAC stands for MPEG-4 Audio.

- Sampling rates of 32 kHz, 44.1 kHz and 48 kHz and bitrates of between 16 and 320 kbps, are supported. Incompatible files cannot be played.
- Variable bit-rate (VBR) files are supported. (Playing times may not display correctly.)
- M4A files must have a ".m4a" or ".M4A" filename extension.

USB Mass Storage Device Requirements

- The AV receiver supports USB devices that support the USB mass storage device class.
- Playback may not be possible with some USB devices even if they conform to the USB mass storage device class.
- USB devices formatted with the FAT16 or FAT32 file system are supported.
- If the storage device has been partitioned, only music files in the first partition can be played.
- Each folder may contain up to 500 music files, and folders may be nested up to eight levels deep.
- Digital audio signals are not output by the digital outputs when playing music files.
- USB hubs and USB devices with hub functions are not supported.

Server Requirements

The AV receiver can play digital music files stored on a computer or media server and supports the following technologies:

- Windows Media Player 11
- Windows Media Connect 2.0
- UPnP AV-compatible media server
- DLNA-compatible media server

Windows Media Player 11 and Windows Media Connect 2.0 can be downloaded for free from the Microsoft Web site.

- The computer or media server must be on the same network as the AV receiver.
- Each folder may contain up to 500 music files, and folders may be nested up to eight levels deep.
- Digital audio signals are not output by the digital outputs when playing music files.

Minimum system requirements for Windows Media Player 11 (for Windows XP)

Operating system

Windows XP Home Edition (SP2), Windows XP Professional (SP2), Windows XP Tablet PC Edition (SP2), Update Rollup 2 for Windows XP Media Center Edition 2005 (KB900325), October 2006 Update Rollup for Windows XP Media Center Edition (KB925766)

Processor: 233 MHz Intel Pentium II, Advanced Micro Devices (AMD), etc.

Memory: 64 MB

Hard disk: 200 MB of free space

Drive: CD or DVD drive

Modem: 28.8 kbps

Sound card: 16-bit sound card

Monitor: Super VGA (800 x 600)

Video card: 64 MB VRAM, DirectX 9.0b

Software: Microsoft ActiveSync (only when using a Windows Mobile-based Pocket PC or smartphone)

Web browser: Microsoft Internet Explorer 6 or Netscape 7.1

Network Requirements

■ Ethernet Network

The AV receiver's Ethernet port supports 10Base-T. For best results, a 100Base-TX switched Ethernet network is recommended. Although it's possible to play music on a computer that's connected to the network wirelessly, playback may be unreliable, so wired connections are recommended.

■ Ethernet Router

A router manages the network, routing data and supplying IP addresses. Your router must support the following:

- NAT (Network Address Translation). NAT allows several networked computers to access the Internet simultaneously via a single Internet connection. The AV receiver needs Internet access for Internet radio.
- DHCP (Dynamic Host Configuration Protocol). DHCP supplies IP addresses to network devices, allowing them to configure themselves automatically.
- A router with a 100Base-TX switch built-in is recommended.

Some routers have a modem built-in, and some ISPs require you to use specific routers. Please consult your ISP or computer dealer if you're unsure.

■ CAT5 Ethernet cable

Use a shielded CAT5 Ethernet cable (straight-type) to connect the AV receiver to your home network.

■ Internet Access (for Internet radio)

To receive Internet radio, your Ethernet network must have Internet access. A narrowband Internet connection (e.g., 56K modem, ISDN) will not provide satisfactory results, so a broadband connection is strongly recommended (e.g., cable modem, xDSL modem, etc). Please consult your ISP or computer dealer if you're unsure.

Notes:

- To receive Internet radio with the AV receiver, your broadband Internet connection must be working and able to access the Web. Consult your ISP if you have any problems with your Internet connection.
- The AV receiver uses DHCP to configure its network settings automatically. If you want to configure these settings manually, see page 128.
- The AV receiver does not support PPPoE settings, so if you have a PPPoE-type Internet connection, you must use a PPPoE-compatible router.
- Depending on your ISP, you may need to specify a proxy server to use Internet radio. If your computer is configured to use a proxy server, use the same settings for the AV receiver (see page 128).

Connecting the AV Receiver

To connect the AV receiver to your home network, plug one end of a shielded CAT5 Ethernet cable into the AV receiver's ETHERNET port, and plug the other end into a LAN port on your router or switch.

The following diagram shows how you can connect the AV receiver to your home network. In this example, it's connected to a LAN port on a router, which has a 4-port 100Base-TX switch built-in.

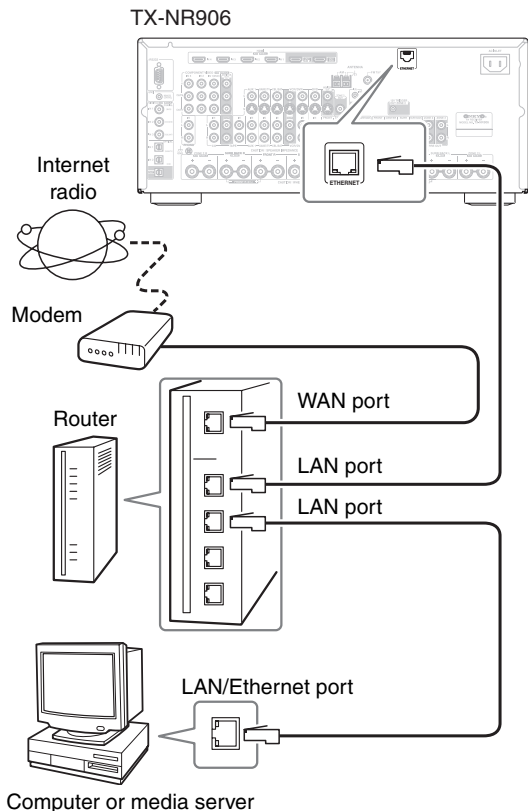

Playing Music Files on a Server

This section explains how to play music files on a computer or media server through the AV receiver. See page 121 for details on supported music servers and music file formats.

- 1 Start your computer or media server.**
- 2 Press the [NET/USB] INPUT SELECTOR button to select the Server screen.**

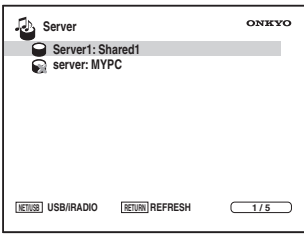
The NETWORK indicator lights up if the AV receiver is able to establish a connection to the server. It flashes if a connection cannot be established.
- 3 Press the [NET/USB] REMOTE MODE button to select the NET/USB remote controller mode.**

- 4 Use the Up and Down [▲]/[▼] buttons to select a server, and then press [ENTER].**

A list of items on the server appears.

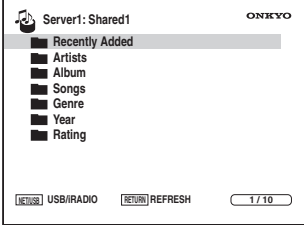

- 5 Use the Up and Down [▲]/[▼] buttons to select an item, and then press [ENTER].**

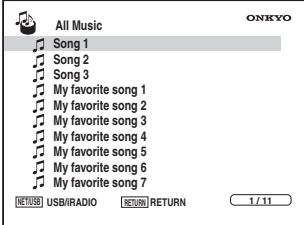
A list of music files appears.

6



Use the Up and Down [▲]/[▼] buttons to select a music file, and press the [ENTER] or Play [▶] button to start playback. Playback starts and the following screen appears.

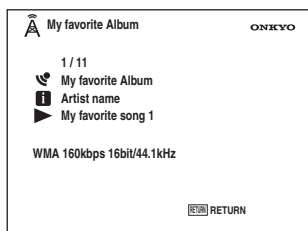

To return to the previous menu during playback, press the [Return] button.
 To stop playback, press the Stop [■] button.
 To select the next song, press the Next [▶▶] button. To select the beginning of the current song, press the Previous [◀◀] button. To select the previous song, press the Previous [◀◀] button twice.

Random Playback

To play songs in random order, while the list of songs is displayed, press the [RANDOM] button. All of the songs in the current folder will be played in random order. When all of the songs in the folder have been played once, they'll all be played again in a different random order. To cancel random playback, press the [RANDOM] button again.

Random playback supports up to 9,999 songs per folder. If a folder contains more than this, songs over 9,999 are not included in random playback.

Repeat Playback

The Repeat function can only be set while the PLAY screen is displayed.

To play songs repeatedly, during playback (or while playback is paused or stopped), press the [REPEAT] button repeatedly to select: Repeat1, Repeat, All, or Off.

In Repeat1 mode, the current song is played repeatedly.

In Repeat mode, all of the songs in the current folder are played repeatedly.

In All mode, all of the songs on the current server are played repeatedly.

To cancel repeat playback, press the [REPEAT] button repeatedly to select Off.

Note:

If the message “No item” appears, this means that no information can be retrieved from the server. In this case, check your server, network, and AV receiver connections.

Windows Media Player 11 Setup

This section explains how to configure Windows Media Player 11 so that the AV receiver can play the music files stored on your computer.

- 1 Start Windows Media Player 11.**
- 2 On the Library menu, select Media Sharing.**
The Media Sharing dialog box appears.
- 3 Select the Share my media check box, and then click OK.**
A list of devices that support PlaysForSure appears.
- 4 Select the AV receiver in the list, and then click Allow.**
- 5 Click OK to close the dialog box.**
This completes the Windows Media Player 11 configuration.
You can now play the music files in your Windows Media Player 11 library through the AV receiver (see page 123).

Note:

Windows Media Player 11 can be downloaded for free from the Microsoft Web site.

Playing Music Files on a USB Device

This section explains how to play music files on a USB mass storage device. See page 121 for details on supported USB mass storage devices and music file formats.

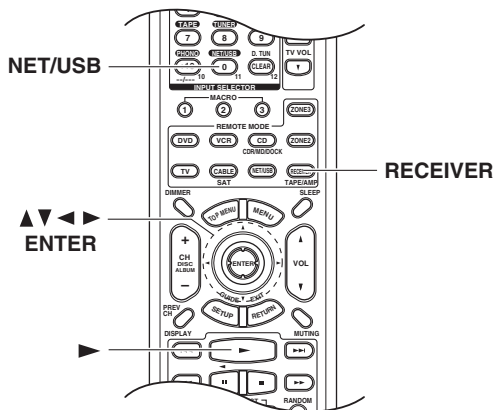

- 1** Plug your USB mass storage device into the AV receiver's USB port.
- 2** Press the [NET/USB] INPUT SELECTOR button repeatedly to select the USB screen.

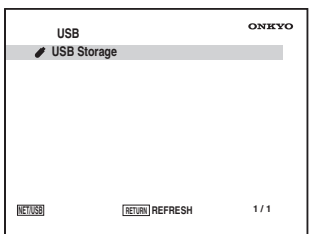



The USB indicator lights up if the AV receiver is able to read the USB mass storage device. It flashes if it cannot read it.
- 3** Press the [NET/USB] REMOTE MODE button to select the NET/USB remote controller mode.

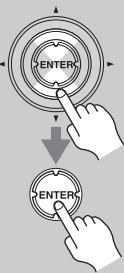
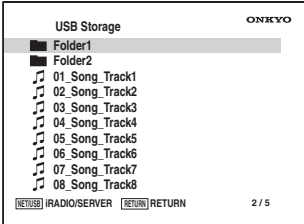

4 Use the Up and Down [▲]/[▼] buttons to select a USB mass storage device, and then press [ENTER].

A list of the device's contents appears.

To open a folder, use the Up and Down [▲]/[▼] buttons to select it, and then press [ENTER].

5 Use the Up and Down [▲]/[▼] buttons to select a music file, and press the [ENTER] or Play [▶] button to start playback.

Playback starts and the following screen appears.

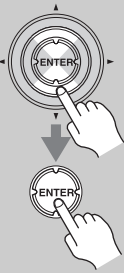

or

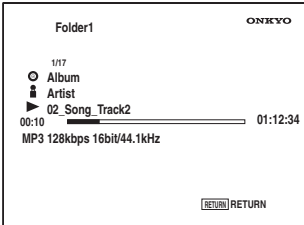
To return to the previous menu during playback, press the [RETURN] button. To stop or pause playback, press the Stop [■] or Pause [⏸] button, respectively.

To select the next song, press the Next [▶▶] button. To select the beginning of the current song, press the Previous [◀◀] button. To select the previous song, press the Previous [◀◀] button twice.

Random Playback

To play songs in random order, while the list of songs is displayed, press the [RANDOM] button. All of the songs in the current folder will be played in random order.

When all of the songs in the folder have been played once, they'll all be played again in a different random order. To cancel random playback, press the [RANDOM] button again.

Random playback supports up to 9,999 songs per folder. If a folder contains more than this, songs over 9,999 are not included in random playback.

Repeat Playback

The Repeat function can only be set while the PLAY screen is displayed.

To play songs repeatedly, during playback (or while playback is paused or stopped), press the [REPEAT] button repeatedly to select: Repeat1, Repeat, All, or Off.

In Repeat1 mode, the current song is played repeatedly.

In Repeat mode, all of the songs in the current folder are played repeatedly.

In All mode, all of the songs on the USB mass storage device (in the same partition) are played repeatedly.

To cancel repeat playback, press the [REPEAT] button repeatedly to select Off.

Notes:

- If you connect a USB hard disk drive to the AV receiver's USB port, we recommend that you use its AC adapter to power it.
- Do not connect the AV receiver's USB port to a USB port on your computer. Music on your computer cannot be played through the AV receiver in this way.
- The AV receiver supports USB MP3 players that support the USB Mass Storage Class standard, which allows USB storage devices to be connected to computers without the need for special drivers or software. Note that not all USB MP3 players support the USB Mass Storage Class standard. Refer your USB MP3 player's instruction manual for details.
- Protected WMA music files on an MP3 player cannot be played.
- Onkyo accepts no responsibility whatsoever for the loss or damage to data stored on a USB mass storage device when that device is used with the AV receiver. We recommend that you back up your important music files beforehand.
- MP3 players containing music files that are managed with special music software, and iPods containing music files managed with iTunes are not supported.
- Operation with all USB mass storage devices including the ability to power them is not guaranteed.
- Do not connect your USB mass storage device via a USB hub. The USB mass storage device must be connected directly to the AV receiver's USB port.
- If the USB mass storage device contains a lot of data, the AV receiver may take a while to read it.

Listening to Internet Radio

To receive Internet radio, you must connect the AV receiver to a network with Internet access (see page 123).

You can select Internet radio stations by entering the appropriate URL with the remote controller, or by connecting to the AV receiver from your computer and selecting stations in your Web browser.

Internet radio URLs in the following formats are supported: PLS, M3U, and podcast (RSS). However, depending on the type of data or audio format used by the Internet radio station, you may not be able to listen to some stations.

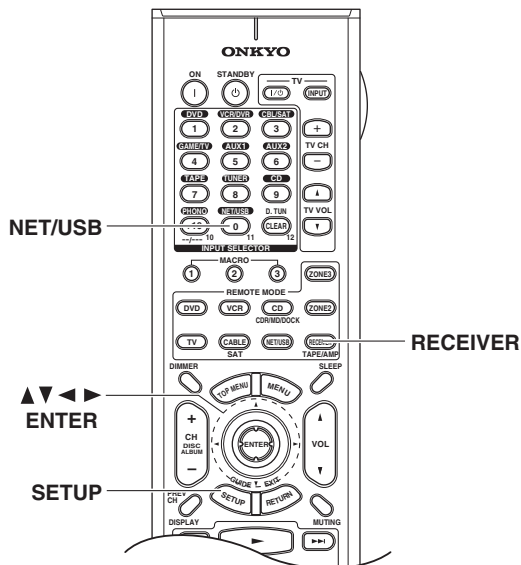

1 Press the [NET/USB] INPUT SELECTOR button repeatedly to select the Internet Radio screen.

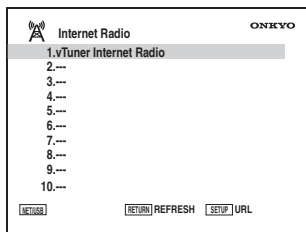

The NETWORK indicator lights up if the AV receiver is able to establish a connection to the network. It flashes if a connection cannot be established. When the program setting is finished, go to Procedure 5.

2 Press the [NET/USB] REMOTE MODE button to select the NET/USB remote controller mode.



3 Use the Up and Down [▲]/[▼] buttons to select an empty item, and then press the [SETUP] button. The URL Input screen appears.



4 Use the remote controller to enter the URL of the Internet radio station you want to listen to.

Use the same method as for the “Name Edit” function on page 110 to enter a URL.

When you’ve finished, select “OK”, and then press [ENTER].

The station appears in the list.

To update the station list, press the [RETURN] button.

OR:

On your computer, start your Web browser and enter the AV receiver’s IP address in the browser’s Internet address (URL) field.

The browser connects to the AV receiver and displays the same screen as the AV receiver.

Select the Internet radio station with your browser.

Notes:

- The AV receiver’s IP address is shown on the “Network” screen (see page 128).
- If you’re using DHCP, your router may not always allocate the same IP address to the AV receiver, so if you find that you can’t connect to the AV receiver, recheck the AV receiver’s IP address on “Network” screen.

5



Press [ENTER].

The station's programs are displayed.

6



Use the Up and Down [▲]/[▼] buttons to select a program, and then press [ENTER].

Playback starts and the following screen appears.

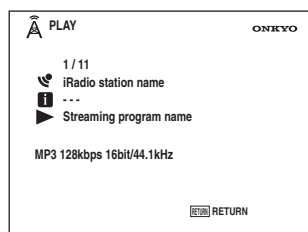

Refer to page 121 for the Internet Radio.

Once you've added a station to the list, simply select it on the Internet Radio screen, and then press [ENTER] to start playback.

Notes:

- When you try the connection after the user preset, if “[?]” is displayed in the list, URL may be entered incorrectly. Check the URL again.
- Even if the entered URL is improper (not the applicable playlist format), some contents may be displayed. In that case, [?] is displayed.
- When connected to an Internet radio station that uses the MP3 streaming format, the MP3 indicator lights up. When connected to an Internet radio station that uses the WMA streaming format, the WMA indicator lights up.
- If you're using a narrowband Internet connection (e.g., 56K modem or ISDN), depending on the station, Internet radio may not work satisfactorily. For best results, use a broadband connection (e.g., cable modem, xDSL modem, etc).

Network Settings

Note:

When modifying network settings, after modifying it is necessary to execute → Save Settings.

This section explains how to configure the AV receiver's network settings manually.

If your router's DHCP server is enabled, you don't need to change any of these settings, as the AV receiver is set use DHCP to configure itself automatically by default (i.e., DHCP is set to Enable). If, however, your router's DHCP server is disabled, for example, you're using static IP addresses, you'll need to configure these settings yourself, in which case, a knowledge of Ethernet networking is essential.

What's DHCP?

DHCP (Dynamic Host Configuration Protocol) is used by routers, computers, the AV receiver, and other devices to automatically configure themselves on a network.

What's DNS?

The DNS (Domain Name System) translates domain names into IP addresses. For example, when you enter a domain name such as *www.onkyousa.com* in your Web browser, before accessing the site, your browser uses DNS to translate this into an IP address, in this case 63.148.251.142.

1



Press the [RECEIVER] REMOTE MODE button, followed by the [SETUP] button.

The main menu appears onscreen.

2

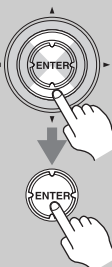

Use the Up and Down [▲]/[▼] buttons to select “7. Hardware Setup”, and then press [ENTER].

The “Hardware Setup” menu appears.

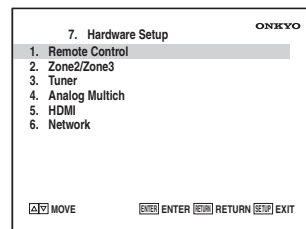

3

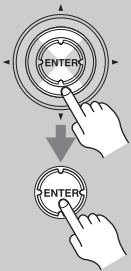

Use the Up and Down [▲]/[▼] buttons to select “6. Network”, and then press [ENTER].

The “Network” screen appears.

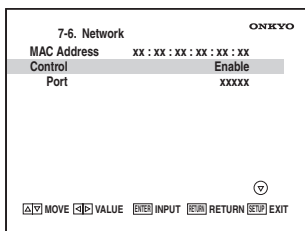

4



Use the Up and Down [▲]/[▼] buttons to select the settings, and use the Left and Right [◀]/[▶] buttons to set them.

To enter an IP address, select the setting, and then press [ENTER]. The arrow [▲]/[▼]/[◀]/[▶] buttons can then be used to enter numbers. Press [ENTER] again to set the number. The settings are explained on the next page.

5

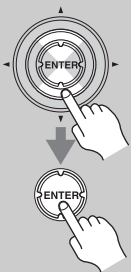

When you’ve finished, press the Up and Down [▲]/[▼] buttons to select “→ Save Settings”, and then press [ENTER].

Setup closes.

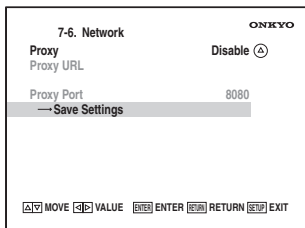

When modifying network settings, after modifying it is necessary to execute “→ Save Settings”.

6



When you’ve finished, press the [SETUP] button.

Setup closes.

Note:

This procedure can also be performed on the AV receiver by using its [SETUP] button, arrow buttons, and [ENTER] button.

Mac Address

This is the AV receiver’s MAC (Media Access Control) address. This address cannot be changed.

Control

This setting enables or disables control over the network.

Enable: Control over the network enabled.

Disable: Control over the network disabled.

■ **Port**

This is the network port used for control over the network.

DHCP

This setting determines whether or not the AV receiver uses DHCP to automatically configure its IP Address, Subnet Mask, Gateway, and DNS Server settings.

Enable: DHCP enabled.

Disable: DHCP disabled.

If you select “Disable”, you must configure the “IP Address”, “Subnet Mask”, “Gateway”, and “DNS Server” settings yourself.

IP Address

If you set the “DHCP” setting to “Disable”, you must specify an IP address. Enter a static IP address provided by your ISP.

The IP address must be within the following ranges.

Class A: 10.0.0.0 to 10.255.255.255

Class B: 172.16.0.0 to 172.31.255.255

Class C: 192.168.0.0 to 192.168.255.255

Most routers use Class C IP addresses.

Subnet Mask

If you set the “DHCP” setting to “Disable”, you must specify a subnet mask address.

Enter the subnet mask address provided by your ISP (typically: 255.255.255.0).

Gateway

If you set the “DHCP” setting to “Disable”, you must specify a gateway address.

Enter the gateway address provided by your ISP.

DNS Server

If you set the “DHCP” setting to “Disable”, you must specify a DNS server.

Enter the DNS server addresses provided by your ISP.

Proxy URL

To use a Web proxy, enter its URL here.

Proxy Port

If you’re using a Web proxy, enter a proxy port number here.

Zone 2 and Zone 3

In addition to your main listening room, you can also enjoy playback in two other rooms, or as we call them, Zone 2 and Zone 3. And, you can select a different source for each room.

Connecting Zone 2

There are two ways you can connect Zone 2 speakers:

1. Connect them directly to the AV receiver.
2. Connect them to an amp in Zone 2.

Connecting Your Zone 2 Speakers Directly to the AV receiver

This setup allows 5.1-channel playback in your main room and 2-channel stereo playback in Zone 2, with a different source in each room. This is called Powered Zone 2, as the Zone 2 speakers are powered by the AV receiver. Note that when Powered Zone 2 is turned off, you can enjoy 7.1-channel playback in your main room.

To use this setup, you must set the “Speaker Type: Front(Speaker B)” setting to “Not Use” (see page 61), and set the “Powered Zone 2” setting to “Act” (see page 132).

Hookup

- Connect your Zone 2 speakers to the AV receiver’s ZONE 2 L/R speaker terminals.

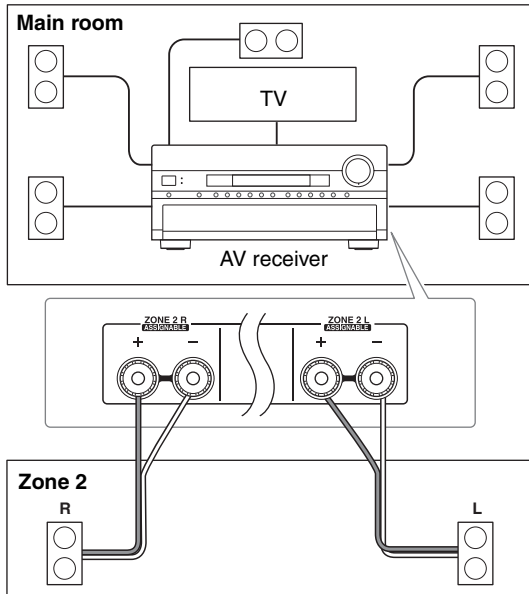

Notes:

- With this setup, the Zone 2 volume is controlled by the AV receiver.
- Powered Zone 2 cannot be used if “Speaker Type: Front(Speaker A)” is set to “Bi-Amp” or “BTL”, or “Speaker Type: Front(Speaker B)” is set to “Normal”, “Bi-Amp”, or “BTL” (page 61).

Connecting Your Zone 2 Speakers to an Amp in Zone 2

This setup allows 7.1-channel playback in your main listening room and 2-channel stereo playback in Zone 2, with a different source in each room.

Hookup

- Use an RCA audio cable to connect the AV receiver’s ZONE 2 PRE OUT L/R jacks to an analog audio input on your Zone 2 amp.
- Connect your Zone 2 speakers to the speaker terminals on your Zone 2 amp.

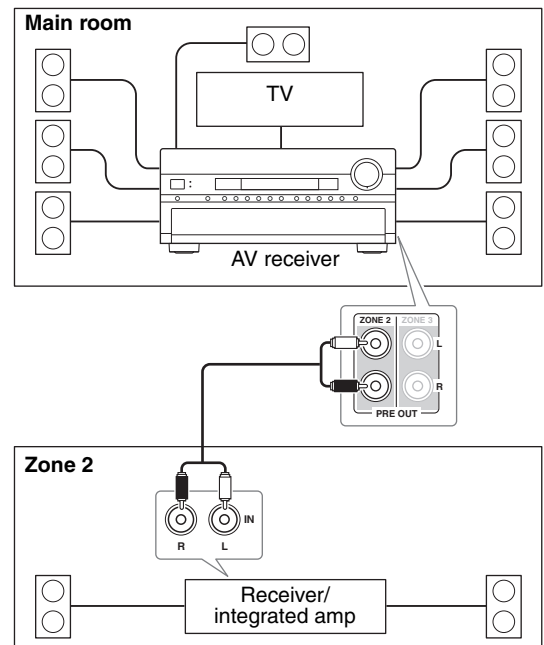

Note:

With the default settings, the Zone 2 volume must be set on the Zone 2 amp. If your Zone 2 amp has no volume control, set the “Zone2 Out” setting to “Variable” so that you can set the Zone 2 volume on the AV receiver (see page 133).

Zone 2 and Zone 3—Continued

Zone 2 Video Output

The AV receiver features a composite video output for connection to a TV in Zone 2, so you can enjoy both audio and video in that zone.

Hookup

- Use a composite video cable to connect the AV receiver's ZONE 2 OUT V jack to a composite video input on your Zone 2 TV.

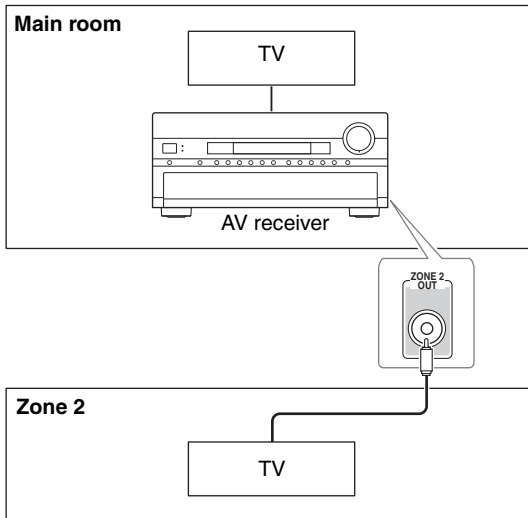

Note:

The ZONE 2 OUT V jack outputs video from components connected to composite video inputs and S-Video inputs.

Zone 2 12V Trigger

When Zone 2 is turned on, the output from the 12V TRIGGER OUT ZONE 2 goes high (+12 volts, 100 milliamperes max). Connecting this jack to a 12-volt trigger input on a component in Zone 2 will make that component turn on or off as and when Zone 2 is turned on or off on the AV receiver.

Connecting Zone 3

Zone 3 speakers must be connected to an amp in Zone 3.

Connecting Your Zone 3 Speakers

You can enjoy 2-channel stereo playback in Zone 3 and a different source to those selected for your main room and Zone 2.

Hookup

- Use an RCA audio cable to connect the AV receiver's ZONE 3 PRE OUT L/R jacks to an analog audio input on your Zone 3 amp.
- Connect your Zone 3 speakers to the speaker terminals on your Zone 3 amp.

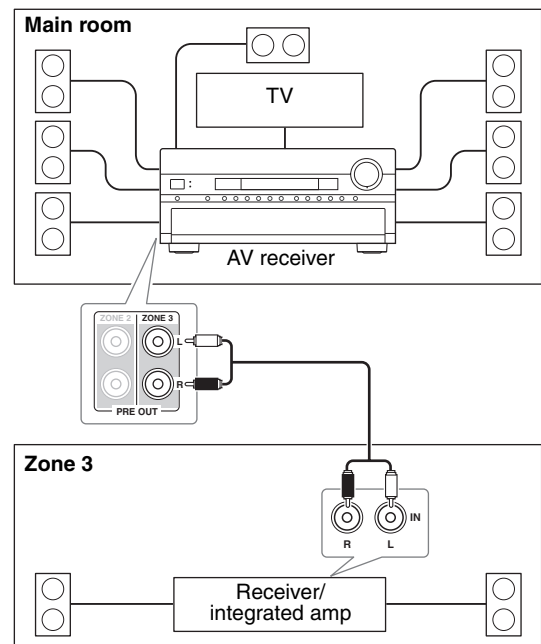

Note:

With the default settings, the Zone 3 volume must be set on the Zone 3 amp. If your Zone 3 amp has no volume control, set the "Zone3 Out" setting to "Variable" so that you can set the Zone 3 volume on the AV receiver (see page 133).

Powered Zone2 Setting

If you've connected your Zone 2 speakers to the AV receiver, as explained in "Connecting Your Zone 2 Speakers Directly to the AV receiver" on page 130, you must set the "Powered Zone2" setting to "Act" (Activated).

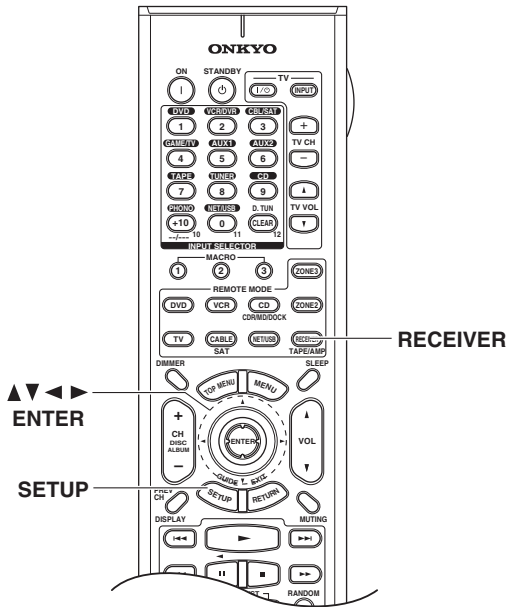

1 Press the [RECEIVER] REMOTE MODE button, followed by the [SETUP] button. The main menu appears onscreen. If the main menu doesn't appear, make sure the appropriate external input is selected on your TV.

2 Use the Up and Down [▲]/[▼] buttons to select "7. Hardware Setup", and then press [ENTER]. The "Hardware Setup" menu appears.

3 Use the Up and Down [▲]/[▼] buttons to select "2. Zone2/Zone3", and then press [ENTER]. The "Zone2/Zone3" screen appears.

ONKYO	
7-2. Zone2/Zone3	
Powered Zone2	Not Act
Zone2 Out	Fixed
Zone3 Out	Fixed
▲▼ MOVE ◀▶ VALUE ◻ RETURN ◻ EXIT	

4 Use the Up and Down [▲]/[▼] buttons to select "Powered Zone2", and use the Left and Right [◀]/[▶] buttons to select:
Not Act: ZONE 2 L/R speaker terminals not activated (Powered Zone 2 disabled).
Act: ZONE 2 L/R speaker terminals activated (Powered Zone 2 enabled).

5 Press the [SETUP] button. Setup closes.

- Notes:**
- When "Act" is selected and Zone 2 turned on, the Zone 2 speakers connected to the ZONE 2 L/R speaker terminals output sound, but the surround back speakers connected to the SURR BACK L/R speaker terminals do not. When "Act" is selected and Zone 2 turned off, the surround back speakers output sound as normal.
 - Powered Zone 2 cannot be used if "Speaker Type: Front(Speaker A)" is set to "Bi-Amp" or "BTL", or "Speaker Type: Front(Speaker B)" is set to "Normal", "Bi-Amp", or "BTL" (page 61).
 - This procedure can also be performed on the AV receiver by using its [SETUP] button, arrow buttons, and [ENTER] button.

Zone 2/Zone 3 Out Settings

If you've connected your Zone 2 or Zone 3 speakers to an amp with no volume control, set the "Zone2 Out" or "Zone3 Out" setting, respectively, to "Variable" so that you can set the zone's volume, balance, and tone on the AV receiver.

1 Press the [RECEIVER] REMOTE MODE button, followed by the [SETUP] button.



The main menu appears onscreen. If the main menu doesn't appear, make sure the appropriate external input is selected on your TV.

2 Use the Up and Down [▲]/[▼] buttons to select "7. Hardware Setup", and then press [ENTER].

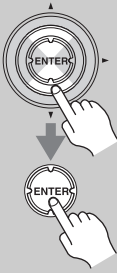

The "Hardware Setup" menu appears.

3 Use the Up and Down [▲]/[▼] buttons to select "2. Zone2/Zone3", and then press [ENTER].



The "Zone2/Zone3" screen appears.

7-2. Zone2/Zone3		ONKYO
Powered Zone2	Not Act	
Zone2 Out	Fixed	
Zone3 Out	Fixed	
MOVE VALUE		RETURN EXIT

4 Use the Up and Down [▲]/[▼] buttons to select "Zone2 Out" or "Zone3 Out", and use the Left and Right [◀]/[▶] buttons to select:

Fixed:
The Zone 2 or Zone 3 volume must be set on the amp in that zone.

Variable:
The Zone 2 or Zone 3 volume can be set on the AV receiver.



5 Press the [SETUP] button. Setup closes.



Note:
This procedure can also be performed on the AV receiver by using its [SETUP] button, arrow buttons, and [ENTER] button.

Using Zone 2 and Zone 3

This section explains how to use Zone 2 and Zone 3.

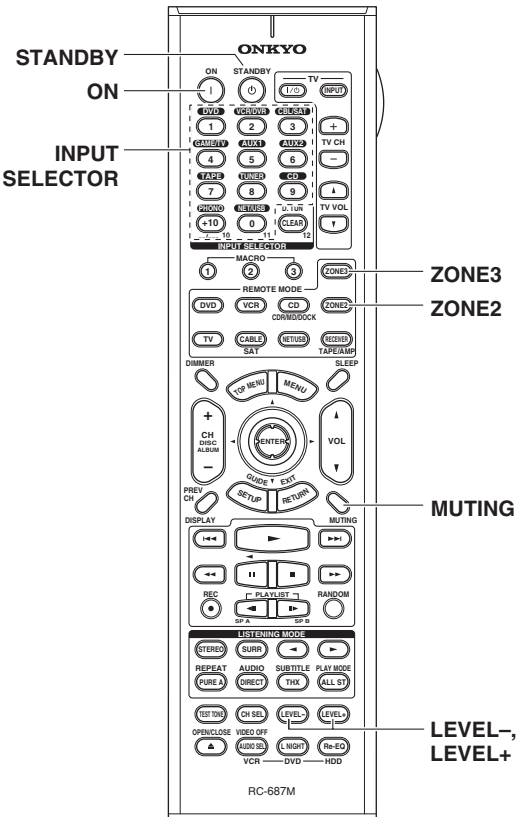
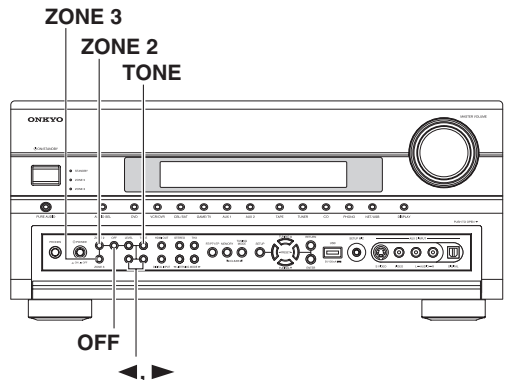

Selecting an Input Source for Zones

1

Remote controller

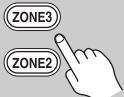

On the remote controller, press the [ZONE2] or [ZONE3] REMOTE MODE button.

AV receiver

ZONE 2



ZONE 3

On the AV receiver, press the [ZONE 2] or [ZONE 3] button.

The ZONE 2 or ZONE 3 indicator flashes, and the input selector currently selected for the zone appears on the display.

2

Remote controller



On the remote controller, use the INPUT SELECTOR buttons.

On the AV receiver, use the input selector buttons, or press the [ZONE 2] or [ZONE 3] button repeatedly.

The input source is selected, the zone is turned on, the name of the input selector appears on the display, and the ZONE 2 or ZONE 3 indicator lights continuously.

or

AV receiver

ZONE 2



ZONE 3

You can also use the AV receiver's INPUT SELECTOR buttons.

Notes:

- To select AM or FM, press the [TUNER] input selector button repeatedly. On the North American model, you can also select XM or SIRIUS.
- Only analog input sources are output by the ZONE 2 PRE OUT, ZONE 3 PRE OUT and ZONE 2 L/R speaker terminals. Digital input sources are not output. If no sound is heard when an input source is selected, check if it's connected to an analog input.
- While Powered Zone 2 is being used, listening modes that need surround back speakers (i.e., Dolby Digital EX, DTS-ES, and THX Ultra2 Cinema) are unavailable.
- When Zone2 is on, Pure Audio cannot be selected.
- When Zone 2 is turned on, the output from the 12V TRIGGER OUT ZONE 2 goes high (+12 volts).
- While Zone 2 or Zone 3 is on, the Auto Power On/Standby and Direct Change **RI** functions do not work.
- You cannot select different AM or FM radio stations for your main room, Zone 2, and Zone 3. The same AM/FM radio station will be heard in each room.
- On the North American model, you can select a different radio source for each room. For example, XM for

your main room, SIRIUS for Zone 2, and AM/FM for Zone 3.

Turning Off Zones

1

Remote controller



On the remote controller, press the [ZONE2] or [ZONE3] REMOTE MODE button.

On the AV receiver, press the [ZONE 2] or [ZONE 3] button.

The ZONE 2 or ZONE 3 indicator flashes.

2

Remote controller

STANDBY



On the remote controller, press the [STANDBY] button.

On the AV receiver, press the [OFF] button.

The zone is turned off, and the ZONE 2 or ZONE 3 indicator goes off.

AV receiver

OFF



Note:

When Zone 2 is turned off, the output from the 12V TRIGGER OUT ZONE 2 goes low (0 volts).

Adjusting the Volume of Zones

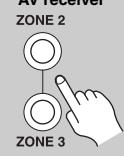
<p>1</p>  <p>Remote controller</p> <p>AV receiver</p> <p>ZONE 2</p> <p>ZONE 3</p>	<p>On the remote controller, press the [ZONE2] or [ZONE3] REMOTE MODE button.</p> <p>On the AV receiver, press the [ZONE 2] or [ZONE 3] button.</p> <p>The ZONE 2 or ZONE 3 indicator flashes.</p>
<p>2</p>  <p>Remote controller</p> <p>LEVEL- LEVEL+</p> <p>AV receiver</p>	<p>On the remote controller, press the [LEVEL-] and [LEVEL+] button.</p> <p>On the AV receiver, press Up [▶] and Down [◀] button.</p>



Note:

Zones can also be unmuted by adjusting the volume.

Muting Zones

 <p>Remote controller</p> <p>MUTING</p>	<p>On the remote controller, press the [ZONE2] or [ZONE3] REMOTE MODE button, and then press the [MUTING] button.</p> <p>To unmute a zone, on the remote controller, press the [ZONE2] or [ZONE3] REMOTE MODE button, and then press the [MUTING] button again.</p>
--	---

Adjusting the Tone and Balance of Zones

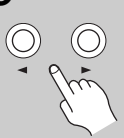
<p>1</p>  <p>AV receiver</p> <p>ZONE 2</p> <p>ZONE 3</p>	<p>On the AV receiver, press the [ZONE 2] or [ZONE 3] button.</p>
<p>2</p>  <p>TONE</p>	<p>Press the AV receiver's [TONE] button repeatedly to select "Bass" "Treble" or "Balance".</p>
<p>3</p> 	<p>Use the Up [▶] and Down [◀] buttons to adjust the Bass, Treble or Balance.</p> <ul style="list-style-type: none"> You can boost or cut the Bass or Treble from -10 dB to +10 dB in 2 dB steps. You can adjust the balance from 0 in the center to +10 dB to the right or +10 dB to the left in 2 dB steps.

Notes:

- The tone cannot be adjusted for Zone 3.
- The Zone 2 level, balance, and tone functions have no effect on the ZONE 2 PRE OUT when the "Zone2 Out" setting is set to "Fixed" (page 133).
- The Zone 3 level and balance functions have no effect on the ZONE 3 PRE OUT when the "Zone3 Out" setting is set to "Fixed" (page 133).

Using the Remote Controller in Zone 2/3 and Multiroom Control Kits

To control the AV receiver with the remote controller while you're in Zone 2 or Zone 3, you'll need a commercially available multiroom remote control kit for each zone.

- Multiroom kits are made by Niles and Xantech. These kits can also be used when there isn't a clear line of sight to the AV receiver's remote sensor, such as when it's installed inside a cabinet.

Using a Multiroom Kit with Zone 2/3

In this setup, the IR receiver in Zone 2/3 picks up the infrared signals from the remote controller and feeds them through to the AV receiver in the main room via the connecting block.

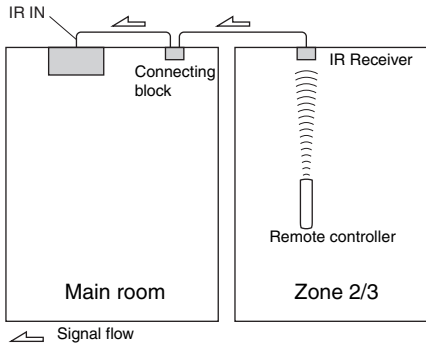

The miniplug cable from the connecting block should be connected to the AV receiver's IR IN jack, as shown below.

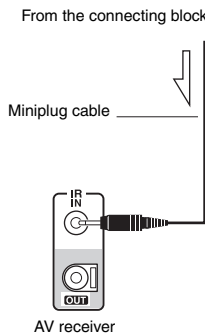

Using a Multiroom Kit with a Cabinet

In this setup, the IR receiver picks up the infrared signals from the remote controller and feeds them to the AV receiver located in the cabinet via the connecting block.

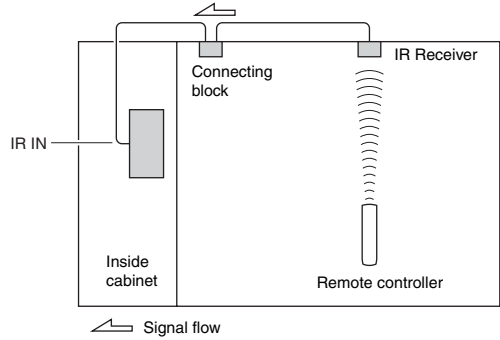

Using a Multiroom Kit with Other Components

In this setup, an IR emitter is connected to the AV receiver's IR OUT jack and placed in front of the other component's remote control sensor. Infrared signals received at the AV receiver's IR IN jack are fed through to the other component via the IR emitter. Signals picked up by the AV receiver's remote control sensor are not output.

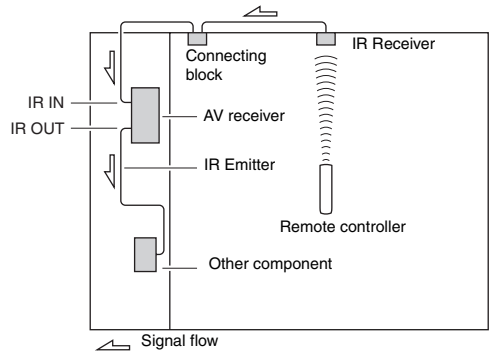

The IR emitter should be connected to the AV receiver's IR OUT jack, as shown below.

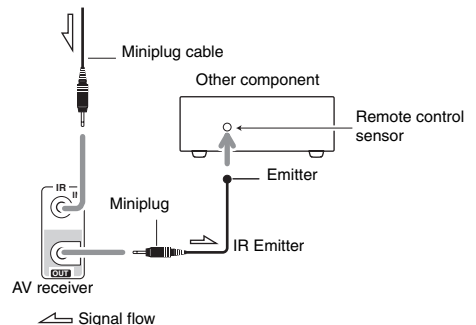

Controlling Other Components

You can control your other components, including those made by other manufacturers, with the remote controller. This section explains how to:

- Enter the remote control code for a component that you want to control: DVD, TV, VCR, etc.
- Learn commands directly from another component's remote controller (see page 140).
- Program the MACRO buttons to perform a sequence of up to eight remote control actions (see page 141).

Entering Remote Control Codes

To control another component, you must first enter that component's remote control code to a REMOTE MODE button. You'll need to enter a code for each component that you want to control.

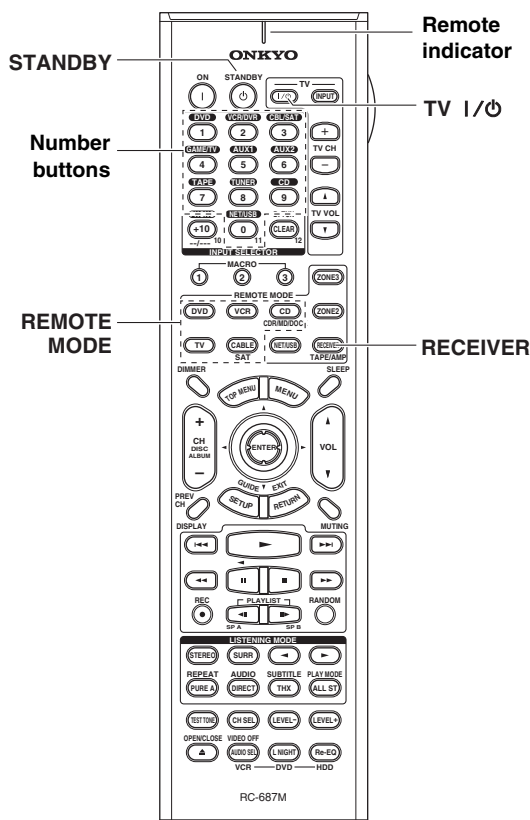

- 1 Look up the component's remote control code in the separate Remote Control Codes list.**
The codes are organized by category.

- 2 While holding down the REMOTE MODE button to which you want to enter the code, press the [STANDBY] button.**
The Remote indicator lights up.
- 3 Within 30 seconds, use the number buttons to enter the 4-digit remote control code.**
The Remote indicator flashes twice.
- 4 Press the REMOTE MODE button again to select the remote controller mode, point the remote controller at the component, and check the operation.**
If the remote controller doesn't work as expected, and several remote codes are listed, try each one in turn and use the one that works best.

Notes:

- Remote control codes cannot be entered for the [RECEIVER], [ZONE 2], [ZONE 3], and [NET/USB] REMOTE MODE buttons.
- The remote control codes provided are correct at the time of printing but subject to change.

- The [DVD] and [CD] REMOTE MODE buttons are preprogrammed for use with Onkyo DVD players and CD players, respectively.
- To control another manufacturer's CD recorder, MD recorder or Onkyo RI Dock, enter the appropriate remote control code to the [CD] REMOTE MODE button.

Remote Control Codes for Onkyo Components Connected via RI

Onkyo components that are connected via **RI** are controlled by pointing the remote controller at the **AV** receiver, not the component. This allows you to control components that are out of view, in a rack, for example.

1 Make sure the Onkyo component is connected with an **RI** cable and an analog audio cable (**RCA**).

See page 50 for details.

2 Enter the appropriate remote control code to the **REMOTE MODE** button.

- [DVD] **REMOTE MODE** button
5002: Onkyo DVD player with **RI**
- [CD] **REMOTE MODE** button
6002: Onkyo CD player with **RI**
- [MD] **REMOTE MODE** button
6008: Onkyo MD recorder with **RI**
- [CDR] **REMOTE MODE** button
6006: Onkyo CD recorder with **RI**
- [DOCK] **REMOTE MODE** button
6004: Onkyo RI Dock with **RI**

See the previous page for how to enter remote control codes.

3 Press the **REMOTE MODE** button, point the remote controller at the **AV** receiver, and operate the component.

If you want to control an Onkyo component by pointing the remote controller directly at it, or you want to control an Onkyo component that's not connected via **RI**, use the following remote control codes:

- [DVD] **REMOTE MODE** button
5001: Onkyo DVD player without **RI** (default)
- [CD] **REMOTE MODE** button
6001: Onkyo CD player without **RI** (default)
- [MD] **REMOTE MODE** button
6007: Onkyo MD recorder without **RI**
- [CDR] **REMOTE MODE** button
6005: Onkyo CD recorder without **RI**
- [DOCK] **REMOTE MODE** button
6003: Onkyo RI Dock without **RI**

Note:

If you connect an **RI**-capable Onkyo MiniDisc recorder, CD recorder, or RI Dock to the TAPE IN/OUT jacks, or connect an RI Dock to the AUX 1 jacks, for **RI** to work properly, you must set the Input Display accordingly (see page 63).

Resetting the **REMOTE MODE** Buttons

You can reset a **REMOTE MODE** button to its default remote control code.

<p>1</p>	<p>While holding down the REMOTE MODE button that you want to reset, press the TV [I/O] button.</p> <p>The Remote indicator flashes three times.</p>
<p>2</p>	<p>Press the REMOTE MODE button again.</p> <p>The Remote indicator flashes twice, indicating that the button has been reset.</p> <p>The [DVD] and [CD] REMOTE MODE buttons are preprogrammed with remote control codes for controlling Onkyo DVD players and CD players, respectively. When these buttons are reset, the preprogrammed codes are restored.</p>

Resetting the Remote Controller

You can reset the remote controller to its default settings.

<p>1</p>	<p>While holding down the [RECEIVER] REMOTE MODE button, press the [STANDBY] button.</p> <p>The Remote indicator flashes five times.</p>
<p>2</p>	<p>Press the [RECEIVER] REMOTE MODE button again.</p> <p>The Remote indicator flashes twice, indicating that the remote controller has been reset.</p>

Controlling Other Components—Continued

To control another component, point the remote controller at it and use the buttons explained below. (You must select the appropriate remote controller mode with the REMOTE MODE buttons first.) With some components, certain buttons may not work as expected, and some may not work at all.

■ Controlling a TV

Press [TV] first

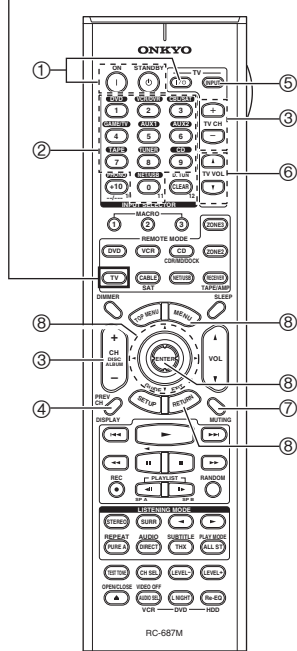

- ① [ON], [STANDBY], TV [I/⏻]*
Set the TV to On or Standby.
- ② **Number buttons**
Enter numbers.
- ③ [CH +/-], TV CH [+]/[-]*
Select channels on the TV.
- ④ [PREV CH]
Selects the previous channel.
- ⑤ [TV INPUT]*
Selects the TV's external inputs.
- ⑥ TV VOL [▲]/[▼]*
Adjust the TV's volume.
- ⑦ [MUTING]
Mutes the TV.
- ⑧ [▲]/[▼]/[◀]/[▶]/[MENU]/[ENTER]/[RETURN]
Navigate menus on the TV.

■ Controlling a VCR

Press [VCR] first

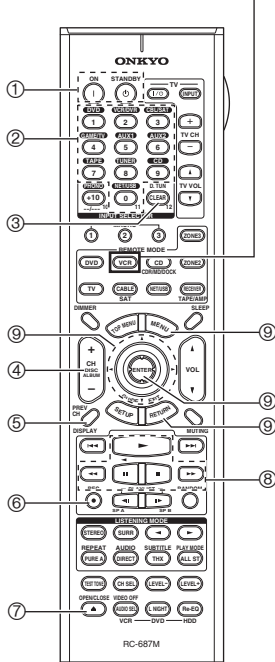

- ① [ON], [STANDBY]
Set the VCR to On or Standby.
- ② **Number buttons**
Enter numbers.
- ③ [CLEAR]
Cancels functions.
- ④ [CH +/-]
Selects channels on the VCR.
- ⑤ [PREV CH]
Selects the previous channel.
- ⑥ REC [●]
Starts recording.
- ⑦ Eject [▲]
Ejects the videocassette.
- ⑧ [▶], [⏸], [■], [◀◀], [▶▶]
Play, Pause, Stop, Rewind, and Fast forward.
- ⑨ [▲]/[▼]/[◀]/[▶]/[MENU]/[ENTER]/[RETURN]
Navigate menus on the VCR.

■ Controlling a Satellite or Cable Receiver

Press [CABLE] (SAT) first

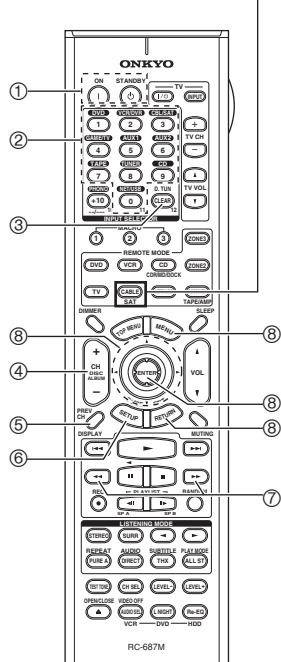

- ① [ON], [STANDBY]
Set the satellite/cable receiver to On or Standby.
- ② **Number buttons**
Enter numbers.
- ③ [CLEAR]
Cancels functions.
- ④ [CH +/-]
Selects satellite/cable channels.
- ⑤ [PREV CH]
Selects the previous channel.
- ⑥ [GUIDE]
Displays the program guide.
- ⑦ [◀◀], [▶▶]
Fast Reverse and Fast forward.
- ⑧ [▲]/[▼]/[◀]/[▶]/[MENU]/[ENTER]/[RETURN]
Navigate menus on the satellite/cable receiver.

Buttons marked with an asterisk () are exclusively for controlling a TV and can be used at any time, regardless of the currently selected remote controller mode.

Learning Commands

The AV receiver's remote controller can learn the commands of other remote controllers. By transmitting, for example, the Play command from your CD player's remote controller, the remote controller can learn it, and then transmit the exact same command when its Play [▶] button is pressed in the CD remote mode.

This is useful when you've entered the appropriate remote control code (page 137) but some buttons don't work as expected.

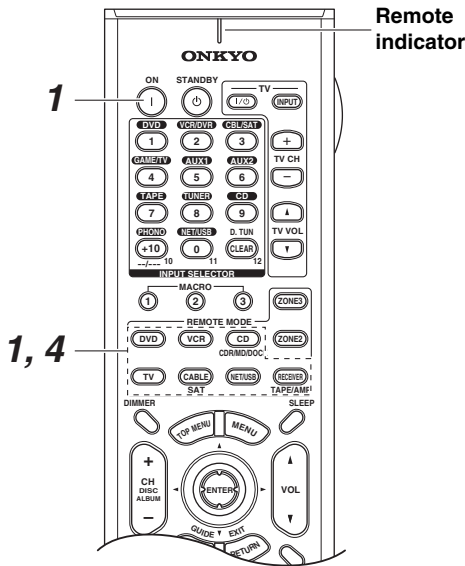

1 While holding down the **REMOTE MODE** button for the mode in which you want to use the command, press the **[ON]** button. The Remote indicator lights up.

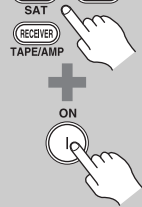

2 Press the button you want to learn the new command.

3 Point the remote controllers at each other, about 2 to 6 inches (5–15 cm) apart, and then press and hold the button whose command you want to learn until the Remote indicator flashes.

If the command is learned successfully, the Remote indicator flashes twice.

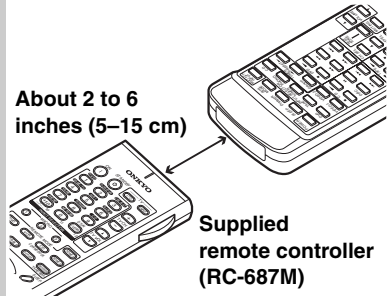

4 To learn more commands, repeat steps 2 and 3.

Press any REMOTE MODE button when you've finished.

Notes:

- The following buttons cannot learn new commands: REMOTE MODE, MACRO [1], [2], [3], TV CH [+]/[-], Re-EQ, LIGHT.
- When you want to learn the command from your TV's Power button, select the TV remote control mode and use the remote controller's [STANDBY] button to learn the command. In the TV remote control mode, the remote controller's [STANDBY] and TV [I/⊕] buttons are linked, so using the [STANDBY] button to learn the command will mean that you can also use the TV [I/⊕] button to turn your TV on or off in TV remote control mode.
- When you want to learn the commands from your TV's Channel Up and Down buttons, select the TV remote control mode and use the remote controller's CH [+/-] button (left to the [ENTER] button) to learn the commands. In the TV remote control mode, the remote controller's CH [+/-] and TV CH [+]/[-] buttons are linked, so using the CH [+/-] button to learn these commands will mean that you can also use the TV CH [+]/[-] buttons to change channels in TV remote control mode.
- The remote controller can learn approximately 70 to 90 commands, although this will be less if commands that use a lot of memory are learned.
- Remote controller buttons such as Play, Stop, Pause, and so on are preprogrammed with commands for controlling Onkyo CD players, cassette decks, and DVD players. However, they can learn new commands, and you can restore the preprogrammed commands at any time by resetting the remote controller (see page 138).
- To overwrite a previously learned command, repeat this procedure.
- Only commands from infrared remote controllers can be learned.
- When the remote controller's batteries expire, all learned commands will be lost and will have to be learned all over again, so don't discard your other remote controllers.

Using Macros

You can program the remote controller's MACRO buttons to perform a sequence of remote control actions.

Example:

To play a CD you typically need to perform the following actions:

1. Press the [RECEIVER] REMOTE MODE button to select the Receiver remote controller mode.
2. Press the [ON] button to turn on the AV receiver.
3. Press the [CD] INPUT SELECTOR button to select the CD input source.
4. Press the [CD] REMOTE MODE button to select the CD remote controller mode.
5. Press the Play [▶] button to start playback on the CD player.

You can program a MACRO button so that all five actions are performed with just one button press.

Making Macros

Each MACRO button can store one macro, and each macro can contain up to eight commands.

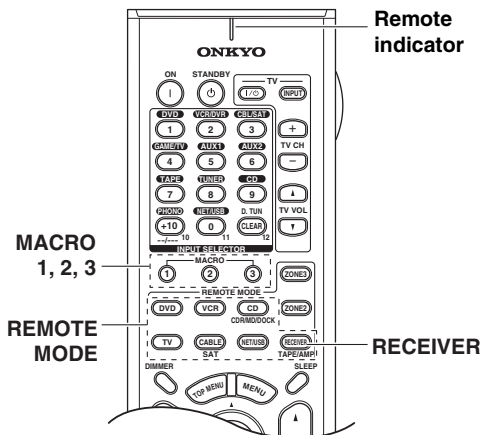

1

While holding down the REMOTE MODE button of the remote controller mode you want to use at the start of the macro, press MACRO button [1], [2], or [3].

The Remote indicator lights up.

For the CD example in the left column, you'd press and hold the [RECEIVER] REMOTE MODE button, and then press MACRO button [1], [2], or [3].

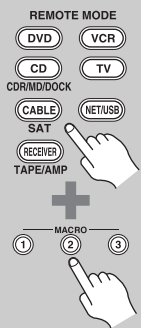

2

Press the buttons whose actions you want to program into the macro in the order you want them performed.

For the CD example in the left column, you'd press the following buttons: [ON], [CD] INPUT SELECTOR, [CD] REMOTE MODE, Play [▶].

3

When you've finished, press the MACRO button again.

The Remote indicator flashes twice. If you enter eight commands, the process will finish automatically.



Note:

If any of the buttons you used to make a macro are taught new commands, the macro will no longer work properly and will have to be made again.

Running Macros



Press the MACRO [1], [2], or [3] button.

The commands in the macro are transmitted in the order in which they were programmed. Keep the remote controller pointed at the AV receiver until all of the commands have been transmitted.

Macros can be run at any time, regardless of the current remote controller mode.

Deleting Macros

1

While holding down the [RECEIVER] REMOTE MODE button, press the MACRO button whose macro you want to delete.



2

Press the MACRO button again.



Troubleshooting

If you have any trouble using the AV receiver, look for a solution in this section. If you can't resolve the issue yourself, contact your Onkyo dealer.

If you can't resolve the issue yourself, try resetting the AV receiver before contacting your Onkyo dealer.

To reset the AV receiver to its factory defaults, turn it on and, while holding down the [VCR/DVR] button, press the [ON/STANDBY] button. "Clear" will appear on the display and the AV receiver will enter Standby mode.

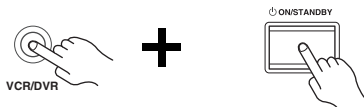

Note that resetting the AV receiver will delete your radio presets and custom settings.

Power

Can't turn on the AV receiver

- Make sure that the power cord is properly plugged into the wall outlet.
- Unplug the power cord from the wall outlet, wait 5 seconds or more, then plug it in again.

The AV receiver turns off as soon as it's turned on

- The amp protection circuit has been activated. Remove the power cord from the wall outlet immediately. Disconnect all speaker cables and input sources, and leave the AV receiver with its power cord disconnected for 1 hour. After that, reconnect the power cord and set the volume to maximum. If the AV receiver stays on, set the volume to minimum, disconnect the power cord, and reconnect your speakers and input sources. If the AV receiver turns off when you set the volume to maximum, disconnect the power cord, and contact your Onkyo dealer.

Audio

There's no sound or it's very quiet

- Make sure that the digital input source is selected properly (page 59).
- Make sure that the correct audio input is selected (page 120).
- Make sure that all audio connecting plugs are pushed in all the way (page 33).
- Make sure that the polarity of the speaker cables is correct, and that the bare wires are in contact with the metal part of each speaker terminal (page 23).
- Make sure that the speaker cables are not shorting.
- Check the volume. It can be set to $-\infty$ dB, -81.5 dB through $+18.0$ dB (page 70). The AV receiver is designed for home theater enjoyment. It has a wide volume range, allowing precise adjustment.

- If the MUTING indicator is flashing on the display, press the remote controller's [MUTING] button to unmute the AV receiver (page 71).
- While a pair of headphones is connected to the PHONES jack, no sound is output by the speakers (page 72).
- Check the digital audio output setting on the connected device. On some game consoles, such as those that support DVD, the default setting is off.
- With some DVD-Video discs, you need to select an audio output format from a menu.
- If your turntable uses an MC cartridge, you must use an MC head amp or MC transformer (page 46).
- Check the speaker settings (pages 95–102).
- The input signal format is set to PCM or DTS. Set it to "Auto" (page 120).
- If there's no sound from a DVD player connected to an HDMI IN, check the DVD player's output settings, and be sure to select a supported audio format.
- Make sure that none of the connecting cables are bent, twisted, or damaged.

Only the front speakers produce sound

- When the Stereo listening mode is selected, only the front speakers and subwoofer produce sound.
- In the Mono listening mode, only the front speakers output sound if the "Output Speaker" setting is set to "L/R" (page 106).
- Check the Speaker Configuration (page 95).

Only the center speaker produces sound

- If you use the Dolby Pro Logic IIX Movie, Dolby Pro Logic IIX Music, or Dolby Pro Logic IIX Game listening mode with a mono source, such as an AM radio station or mono TV program, the sound is concentrated in the center speaker.
- In the Mono listening mode, only the front speakers output sound if the "Output Speaker" setting is set to "C" (page 106).
- Check the Speaker Configuration (page 95).

The surround speakers produce no sound

- When the Stereo or Mono listening mode is selected, the surround speakers produce no sound.
- Depending on the source and the current listening mode, not much sound may be produced by the surround speakers. Try another listening mode (page 81).
- Make sure the speakers are configured correctly (page 95).

The center speaker produces no sound

- When the Stereo listening mode is selected, the center speaker produces no sound.
- In the Mono listening mode, only the front speakers output sound if the "Output Speaker" setting is set to "L/R" (page 106).
- Make sure the speakers are configured correctly (page 95).

The surround back speakers produce no sound

- The surround back speakers are not used with all listening modes. Select another listening mode (page 81).
- Not much sound may be produced by the surround back speakers with some sources.
- Make sure the speakers are configured correctly (page 95).
- While Powered Zone 2 is being used, playback in the main room is reduced to 5.1-channels and the surround back speakers produce no sound (page 130).

The subwoofer produces no sound

- When you play source material that contains no information in the LFE channel, the subwoofer produces no sound.
- Make sure the speakers are configured correctly (page 95).

The Zone 2/3 speakers produce no sound

- The Zone 2/3 speakers only output sources that are connected to an analog input. Check to see if the source component is connected to an analog input.
- Powered Zone 2 cannot be used if “Speaker Type: Front(Speaker A)” is set to “Bi-Amp” or “BTL”, or “Speaker Type: Front(Speaker B)” is set to “Normal”, “Bi-Amp”, or “BTL” (page 61).

There's no sound with a certain signal format

- Check the digital audio output setting on the source component. On some game consoles, such as those that can play DVDs, the default setting is off.
- With some DVD-Video discs, you need to select an audio format from a menu or with the [AUDIO] button on your DVD player's remote controller.
- Depending on the input signal, some listening modes cannot be selected (pages 82-86).

Can't get 6.1- or 7.1-channel playback

- While Powered Zone 2 is being used, playback in the main room is reduced to 5.1-channels and the surround back speakers produce no sound (page 130).

Can't select the Pure Audio listening mode

- The Pure Audio listening mode cannot be selected while Zone 2 is on.

The volume cannot be set as required (The volume cannot be set to +18.0 dB)

- Check to see if a maximum volume has been set (page 115).
- After the Automatic Speaker Setup function has been run, or the volume level of each individual speaker has been adjusted (pages 71 and 100), the maximum volume may be reduced.

Noise can be heard

- Using cable ties to bundle audio cables with power cords, speaker cables, and so on can degrade audio performance, so don't use them.
- An audio cable may be picking up interference. Try repositioning your cables.

The Late Night function doesn't work

- Make sure the source material is Dolby Digital, Dolby Digital Plus, and Dolby TrueHD (page 109).

The DVD analog multichannel input doesn't work

- Check the DVD multichannel input connections (page 120).
- Make sure that the multichannel input is assigned to the input selector (page 60).
- Make sure that the multichannel input is selected (page 80).
- Make sure that the “Speaker Type” is not set to “Bi-Amp”. The multichannel DVD input cannot be used if “Speaker Type” is set to “Bi-Amp” (page 61).
- Check the audio output settings on your DVD player.

About DTS signals

- When DTS program material ends and the DTS bitstream stops, the AV receiver remains in DTS listening mode and the DTS indicator remains on. This is to prevent noise when you use the pause, fast forward, or fast reverse function on your player. If you switch your player from DTS to PCM, because the AV receiver does not switch formats immediately, you may not hear any sound, in which case you should stop your player for about three seconds, and then resume playback.
- With some CD players, you won't be able to playback DTS material properly even though your player is connected to a digital input on the AV receiver. This is usually because the DTS bitstream has been processed (e.g., output level, sampling rate, or frequency response changed) and the AV receiver doesn't recognize it as a genuine DTS signal. In such cases, you may hear noise.
- When playing DTS program material, using the pause, fast forward, or fast reverse function on your player may produce a short audible noise. This is not a malfunction.

The beginning of audio received by an HDMI IN can't be heard

- Since it takes longer to identify the format of an HDMI signal than it does for other digital audio signals, sound may not be output immediately.

Video

There's no picture

- Make sure that all video connecting plugs are pushed in all the way (page 33).
- Make sure that each video component is properly connected (pages 36-49).
- On your TV, make sure that the video input to which the AV receiver is connected is selected.
- While the Pure Audio listening mode is selected, the video circuitry is turned off and only video signals input through HDMI IN can be output.

- If your TV is connected to the HDMI output, set the “Monitor Out” setting to “HDMI Main” or “HDMI Sub” (page 52), and select “- - -” in the “Video Input Setup” on page 56 to watch composite video, S-Video, and component video sources.
- If your TV is connected to the COMPONENT VIDEO MONITOR OUT, set the “Monitor Out” setting to “Analog” (page 52), and select “- - -” in the “Component Video Setup” on page 58 to watch composite video and S-Video sources.
- If the video source is connected to a component video input, you must assign that input to an input selector (page 58), and your TV must be connected to either the HDMI OUT or COMPONENT VIDEO MONITOR OUT (pages 36 and 42).
- If the video source is connected to an HDMI input, you must assign that input to an input selector (page 56), and your TV must be connected to the HDMI OUT (page 42).

There’s no picture from a source connected to an HDMI IN

- When the “Monitor Out” setting is set to “Analog”, and the “Resolution” setting is set to anything other than “Through” (see page 55), no video is output by the HDMI OUT.
- If the message “Resolution Error” appears on the AV receiver’s display, this indicates that your TV does not support the current video resolution and you need to select another resolution on your DVD player.

The onscreen menus don’t appear

- If your TV is connected to the analog outputs, set the “Monitor Out” setting to “Analog” (page 52).
- On your TV, make sure that the video input to which the AV receiver is connected is selected.
- On non-North American models, specify the TV system used in your area in the “TV Format Setup (not North American models)” on page 62.

The immediate display does not appear

- The immediate display will not appear when the input signal from the COMPONENT VIDEO IN is output to a device connected to the COMPONENT VIDEO MONITOR OUT.
- Depending on the input signal, the immediate display may not appear when the input signal from the HDMI IN is output to a device connected to the HDMI OUT.

Tuner

Reception is noisy, FM stereo reception is noisy, or the FM STEREO indicator doesn’t appear

- Relocate your antenna.
- Move the AV receiver away from your TV or computer.
- Listen to the station in mono (page 73).
- When listening to an AM station, operating the remote controller may cause noise.
- Passing cars and airplanes can cause interference.

- Concrete walls weaken radio signals.
- If nothing improves the reception, install an outdoor antenna.

Remote Controller

The remote controller doesn’t work

- Make sure that the batteries are installed with the correct polarity (page 15).
- Make sure that the remote controller is not too far away from the AV receiver, and that there’s no obstruction between the remote controller and the AV receiver’s remote control sensor (page 15).
- Make sure you’ve selected the correct remote controller mode (page 16).
- Make sure you’ve entered the correct remote control code (page 137).
- Install new batteries. Don’t mix different types of batteries, or old and new batteries (page 15).
- Make sure that the AV receiver is not subjected to direct sunshine or inverter-type fluorescent lights. Relocate if necessary.
- If the AV receiver is installed in a rack or cabinet with colored-glass doors, the remote controller may not work reliably when the doors are closed.
- When using the remote controller to control other manufacturers’ AV components, some buttons may not work as expected.
- Make sure to set the same ID on both the AV receiver and remote controller (page 117).

Can’t control other components

- If it’s an Onkyo component, make sure that the **RI** cable and analog audio cable are connected properly. Connecting only an **RI** cable won’t work (page 50).
- Make sure you’ve selected the correct remote controller mode (page 16).
- If you’ve connected an **RI**-capable Onkyo MD recorder, CD recorder, **RI** Dock to the TAPE IN/OUT jacks, or an **RI** Dock to the AUX 1 jacks, for the remote controller to work properly, you must set the display to MD, CDR, or DOCK (page 63). If you cannot operate it, you will need to enter the appropriate remote control code (page 137).
- The entered remote control code may not be correct. If more than one code is listed, try each one.
- If none of the codes work, use the Learning function to learn the commands of the other component’s remote controller (page 140).
- With some AV components, certain buttons may not work as expected, and some may not work at all.
- To control an Onkyo component that’s connected via **RI**, point the remote controller at the AV receiver. Be sure to enter the appropriate remote control code first (page 138).

- To control an Onkyo component that's not connected via **RI**, or another manufacturer's component, point the remote controller at that component. Be sure to enter the appropriate remote control code first (page 137).

Can't learn commands from another remote controller

- When learning commands, make sure that the transmitting ends of both remote controllers are pointing at each other.
- Are you trying to learn from a remote controller that cannot be used for learning? Some commands cannot be learned, especially those that contain several instructions.

Recording

Can't record

- On your recorder, make sure the correct input is selected.
- To prevent signal loops and damage to the AV receiver, input signals are not fed through to outputs with the same name (e.g., TAPE IN to TAPE OUT or VCR/DVR IN to VCR/DVR OUT).
- When the Pure Audio listening mode is selected, video recording is not possible because no video signals are output. Select another listening mode.

Zone 2/Zone 3

There's no sound

- Only components connected to analog inputs can be played in Zone 2 and Zone 3.

Music Server and Internet Radio

Can't access the server or Internet radio

- Check the network connection between the AV receiver and your router or switch.
- Make sure that your modem and router are properly connected, and make sure they are both turned on.
- Make sure the server is up and running and compatible with the AV receiver (page 122).
- Check the "Network Settings" (page 128).

Playback stops while listening to music files on the server

- Make sure your server is compatible with the AV receiver (page 122).
- If you download or copy large files on your computer, playback may be interrupted. Try closing any unused programs, use a more powerful computer, or use a dedicated server.
- If the server is serving large music files to several networked devices simultaneously, the network may become overloaded and playback may be interrupted. Reduce the number of playback devices on the network, upgrade your network, or use a switch instead of a hub.

Can't connect to the AV receiver from a Web browser

- If you're using DHCP, your router may not always allocate the same IP address to the AV receiver, so if you find that you can't connect to a server or Internet radio station, recheck the AV receiver's IP address on Network screen.
- Check the Network settings (page 128).

USB Mass Storage Device Playback

Can't access the music files on a USB device

- Make sure the USB device is plugged in properly.
- The AV receiver supports USB devices that support the USB mass storage device class. However, playback may not be possible with some USB devices even if they conform to the USB mass storage device class.

Others

The sound changes when I connect my headphones

- When a pair of headphones is connected, the listening mode is set to Stereo, unless it's already set to Stereo, Mono, Direct, or Pure Audio.

The speaker volume cannot be set as required

- When the Automatic Speaker Setup function is used, or the volume is adjusted on the onscreen setup menus, the maximum possible volume setting may change.

The speaker distance cannot be set as required

- In some cases, corrected values suitable for home theater use may be set automatically.

The display doesn't work

- The display is turned off when the Pure Audio listening mode is selected.

How do I change the language of a multiplex source

- On the "Audio Adjust" menu, change the "Multiplex" setting to "Main" or "Sub" (page 107).

The **RI** functions don't work

- To use **RI**, you must make an **RI** connection and an analog audio connection (RCA) between the component and AV receiver, even if they are connected digitally (page 50).
- While Zone 2 or Zone 3 is selected, the **RI** functions don't work.

The functions Auto Power On/Standby and Direct Change don't work for components connected via **RI**

- These functions don't work when Zone 2 is turned on.

When performing "Automatic Speaker Setup", the measurement fails showing the message "Ambient noise is too high".

- This can be caused by any malfunction in your speaker unit. Check if the unit produces normal sounds.

The following settings can be made for the S-Video and composite video inputs

You must use the buttons on the unit to make these settings.

1. While holding down the input selector button for the input source that you want to set, press the [SETUP] button.
2. Use the Left and Right [◀]/[▶] buttons to change the setting.
3. Press the [SETUP] button when you've finished.

• Video Attenuation

This setting can be made for the DVD, VCR/DVR, CBL/SAT, GAME/TV, or AUX input.

If you have a games console connected to the S-Video or composite video input, and the picture isn't very clear, you can attenuate the gain.

Video ATT:OFF: (default).

Video ATT:ON: Gain is reduced by 2 dB.

The AV receiver contains a microcomputer for signal processing and control functions. In very rare situations, severe interference, noise from an external source, or static electricity may cause it to lockup. In the unlikely event that this happens, unplug the power cord from the wall outlet, wait at least 5 seconds, and then plug it back in again.

Onkyo is not responsible for damages (such as CD rental fees) due to unsuccessful recordings caused by this unit's malfunction. Before you record important data, make sure that the material will be recorded correctly.

For North American model, set the AV receiver to Standby before disconnecting the power cord from the wall outlet. For other models, set the AV receiver to Standby and the POWER switch to OFF before disconnecting the power cord.

Video Resolution Chart

The following tables show how video signals at different resolutions are output by the AV receiver.

✓: Output

NTSC

Output Input		HDMI ^{*1}					COMPONENT				S-VIDEO	COMPOSITE
		1080p	1080i	720p	480p	480i	1080i	720p	480p	480i	480i	480i
HDMI	1080p	✓	✓	✓	✓							
	1080i	✓	✓	✓	✓							
	720p	✓	✓	✓	✓							
	480p	✓	✓	✓	✓							
	480i	✓	✓	✓	✓	✓						
COMPONENT	1080i	✓	✓	✓	✓		✓	✓	✓			
	720p	✓	✓	✓	✓		✓	✓	✓			
	480p	✓	✓	✓	✓		✓ ^{*2}	✓ ^{*2}	✓			
	480i	✓	✓	✓	✓	✓	✓ ^{*2}	✓ ^{*2}	✓	✓		
S-VIDEO	480i	✓	✓	✓	✓	✓	✓ ^{*2}	✓ ^{*2}	✓	✓	✓	✓
COMPOSITE	480i	✓	✓	✓	✓	✓	✓ ^{*2}	✓ ^{*2}	✓	✓	✓	✓

PAL

Output Input		HDMI ^{*1}					COMPONENT				S-VIDEO	COMPOSITE
		1080p	1080i	720p	576p	576i	1080i	720p	576p	576i	576i	576i
HDMI	1080p	✓	✓	✓	✓							
	1080i	✓	✓	✓	✓							
	720p	✓	✓	✓	✓							
	576p	✓	✓	✓	✓							
	576i	✓	✓	✓	✓	✓						
COMPONENT	1080i	✓	✓	✓	✓		✓	✓	✓			
	720p	✓	✓	✓	✓		✓	✓	✓			
	576p	✓	✓	✓	✓		✓ ^{*2}	✓ ^{*2}	✓			
	576i	✓	✓	✓	✓	✓	✓ ^{*2}	✓ ^{*2}	✓	✓		
S-VIDEO	576i	✓	✓	✓	✓	✓	✓ ^{*2}	✓ ^{*2}	✓	✓	✓	✓
COMPOSITE	576i	✓	✓	✓	✓	✓	✓ ^{*2}	✓ ^{*2}	✓	✓	✓	✓

*1 The video signal is output only when the “Monitor Out” setting is set to “HDMI Main” or “HDMI Sub”.

*2 The output is limited to 480p for an effective signal in the effect of Macrovision.

■ : The video signal is output only when the “Monitor Out” setting is set to “Analog”.

■ : The video signal will be output only when the “Monitor Out” setting is set to “Analog” and the “Resolution” setting is set to “Through”.

Specifications (TX-SR876)

Amplifier Section

Rated Output Power

North American:

140 watts minimum continuous power per channel, 8 ohm loads, 2 channels driven from 20 Hz to 20 kHz, with a maximum total harmonic distortion of 0.05% (FTC)

160 watts minimum continuous power per channel, 8 ohm loads, 2 channels driven at 1 kHz, with a maximum total harmonic distortion of 0.7% (FTC)

170 watts minimum continuous power per channel, 6 ohm loads, 2 channels driven at 1 kHz, with a maximum total harmonic distortion of 0.1% (FTC)

European:

7 ch × 200 W at 6 ohms, 1 kHz, 1 ch driven (IEC)

Asian:

7 ch × 200 W at 6 ohms, 1 kHz, 1 ch driven (IEC)

Maximum Output Power

Asian:

7 ch × 250 W at 6 ohms, 1 kHz, 1 ch driven (JEITA)

Dynamic Power
320 W (3 Ω Front)
270 W (4 Ω Front)
160 W (8 Ω Front)

THD (Total Harmonic Distortion) 0.05% (Power Rated)
Damping Factor 60 (Front, 1 kHz, 8 Ω)
Input Sensitivity and Impedance 200 mV/47 kΩ (LINE)
2.5 mV/47 kΩ (PHONO MM)

Output Level and Impedance 200 mV/470 Ω (REC OUT)
Phono Overload 70 mV (MM 1 kHz, 0.5%)
Frequency Response 5 Hz–100 kHz/+1 dB–3 dB (Direct mode)
Tone Control ±10 dB, 20 Hz (BASS)
±10 dB, 20 kHz (TREBLE)
Signal to Noise Ratio 110 dB (LINE, IHF-A)
80 dB (PHONO, IHF-A)
Speaker Impedance 4 Ω – 16 Ω

Video Section

Input Sensitivity/Output Level and Impedance 1 V_{p-p}/75 Ω (Component and S-Video Y)
0.7 V_{p-p}/75 Ω (Component Pb/Cb, Pr/Cr)
0.28 V_{p-p}/75 Ω (S-Video C)
1 V_{p-p}/75 Ω (Composite)

Component Video Frequency Response 5 Hz – 100 MHz, –3 dB

Tuner Section

■ FM

Tuning Frequency Range

North American: 87.5 MHz–107.9 MHz

European and Asian: 87.50 MHz–108.00 MHz, RDS

■ AM

Tuning Frequency Range

North American: 530 kHz–1710 kHz

European: 522 kHz–1611 kHz

Others: 522/530 kHz–1611/1710 kHz

Preset Channel 40

■ Digital Tuner

North American: XM, SIRIUS, HD RADIO

General

Power Supply

North American: AC 120 V, 60 Hz

European: AC 220–240 V, 50 Hz

Asian: AC 120/220–240 V, 50/60 Hz

Power Consumption

North American: 9.6 A

European and Asian: 870 W

Dimensions

(W × H × D) 435 × 194 × 458.5 mm

17-1/8" × 7-5/8" × 18-1/16"

Weight

North American: 24.1 kg

53.1 lbs.

European and Asian: 23.3 kg

51.4 lbs.

■ Video Input

HDMI IN 1, IN 2, IN 3, IN 4
Component IN 1 (DVD), IN 2, IN 3
S-Video DVD, VCR/DVR, CBL/SAT, GAME/TV, AUX 1, AUX 2
Composite DVD, VCR/DVR, CBL/SAT, GAME/TV, AUX 1, AUX 2

■ Video Output

HDMI OUT MAIN, OUT SUB
Component MONITOR OUT
S-Video VCR/DVR OUT, MONITOR OUT
Composite VCR/DVR OUT, MONITOR OUT, ZONE 2 OUT

■ Audio Inputs

Digital Inputs OPTICAL: 2 (Rear), 1 (Front)
COAXIAL: 3 (Rear)
Analog Inputs MULTI CH (FRONT, CENTER, SUBWOOFER, SURR, SURR BACK, DVD, VCR/DVR, CBL/SAT, GAME/TV, AUX 1, TAPE, CD, PHONO, AUX 2)
Multichannel Inputs 7.1

■ Audio Outputs

Digital Output OPTICAL: 1 (Rear)
Analog Outputs VCR/DVR OUT, TAPE OUT, PRE OUT (FRONT, CENTER, SUBWOOFER, SURR, SURR BACK, ZONE 2, ZONE 3)

Multichannel Pre

Outputs 7

Subwoofer Pre Outputs 1

Speaker Outputs ZONE 2 R, SURR BACK R, FRONT R, SURR R, CENTER, SURR L, FRONT L, SURR BACK L, ZONE 2 L

Phones 1

■ Control Terminal

MIC Yes

RS232 1

IR Input/Output 1/1

12 V Trigger Out 1

Specifications and features are subject to change without notice.

Specifications (TX-NR906)

Amplifier Section

Rated Output Power

North American:

145 watts minimum continuous power per channel, 8 ohm loads, 2 channels driven from 20 Hz to 20 kHz, with a maximum total harmonic distortion of 0.05% (FTC)

175 watts minimum continuous power per channel, 8 ohm loads, 2 channels driven at 1 kHz, with a maximum total harmonic distortion of 0.7% (FTC)

185 watts minimum continuous power per channel, 6 ohm loads, 2 channels driven at 1 kHz, with a maximum total harmonic distortion of 0.1% (FTC)

European:

7 ch × 220 W at 6 ohms, 1 kHz, 1 ch driven (IEC)

Asian:

7 ch × 220 W at 6 ohms, 1 kHz, 1 ch driven (IEC)

Maximum Output Power

Asian:

7 ch × 280 W at 6 ohms, 1 kHz, 1 ch driven (JEITA)

Dynamic Power 400 W (3 Ω Front)
300 W (4 Ω Front)
180 W (8 Ω Front)

THD (Total Harmonic Distortion) 0.05% (Power Rated)

Damping Factor 60 (Front, 1 kHz, 8 Ω)

Input Sensitivity and Impedance 200 mV/ 47 kΩ (LINE)
2.5 mV/47 kΩ (PHONO MM)

Output Level and Impedance 200 mV/ 470 Ω (REC OUT)

Phono Overload 70 mV (MM 1 kHz, 0.5%)

Frequency Response 5 Hz–100 kHz/ +1 dB–3 dB (Direct mode)

Tone Control ±10 dB, 20 Hz (BASS)
±10 dB, 20 kHz (TREBLE)

Signal to Noise Ratio 110 dB (LINE, IHF-A)
80 dB (PHONO, IHF-A)

Speaker Impedance 4 Ω – 16 Ω

Video Section

Input Sensitivity/Output

Level and Impedance 1 V_{p-p} /75 Ω
(Component and S-Video Y)
0.7 V_{p-p} /75 Ω (Component Pb/Cb,Pr/Cr)
0.28 V_{p-p} /75 Ω (S-Video C)
1 V_{p-p} /75 Ω (Composite)

Component Video

Frequency Response 5 Hz – 100 MHz, –3 dB

Tuner Section

■ FM

Tuning Frequency Range

North American: 87.5 MHz– 107.9 MHz

European and Asian: 87.50 MHz– 108.00 MHz, RDS

■ AM

Tuning Frequency Range

North American: 530 kHz–1710 kHz

European: 522 kHz–1611 kHz

Others: 522/530 kHz–1611/1710 kHz

Preset Channel 40

■ Digital Tuner

North American: XM, SIRIUS, HD RADIO

General

Power Supply

North American: AC 120 V, 60 Hz

European: AC 220-240 V, 50 Hz

Asian: AC 120/220-240 V, 50/60 Hz

Power Consumption

North American: 9.8 A

European and Asian: 1000 W

Dimensions

(W × H × D) 435 × 194 × 458.5 mm

17-1/8" × 7-5/8" × 18-1/16"

Weight

North American: 24.5 kg

54.0 lbs.

European and Asian: 24.3 kg

53.6 lbs.

■ Video Input

HDMI IN 1, IN 2, IN 3, IN 4

Component IN 1 (DVD), IN 2, IN 3

S-Video DVD, VCR/DVR, CBL/SAT, GAME/TV,
AUX 1, AUX 2

Composite DVD, VCR/DVR, CBL/SAT, GAME/TV,
AUX 1, AUX 2

■ Video Output

HDMI OUT MAIN, OUT SUB

Component MONITOR OUT

S-Video VCR/DVR OUT, MONITOR OUT

Composite VCR/DVR OUT, MONITOR OUT,
ZONE 2 OUT

■ Audio Inputs

Digital Inputs OPTICAL: 2 (Rear), 1 (Front)

COAXIAL: 3 (Rear)

Analog Inputs MULTI CH (FRONT, CENTER,
SUBWOOFER, SURR, SURR BACK),
DVD, VCR/DVR, CBL/SAT, GAME/TV,
AUX 1, TAPE, CD, PHONO, AUX 2

Multichannel Inputs 7.1

■ Audio Outputs

Digital Output OPTICAL: 1 (Rear)

Analog Outputs VCR/DVR OUT, TAPE OUT, PRE OUT
(FRONT, CENTER, SUBWOOFER,
SURR, SURR BACK, ZONE 2, ZONE 3)

Multichannel Pre

Outputs 7

Subwoofer Pre Outputs 1

Speaker Outputs ZONE 2 R, SURR BACK R, FRONT R,
SURR R, CENTER, SURR L, FRONT L,
SURR BACK L, ZONE 2 L

Phones 1

■ Control Terminal

MIC Yes

Ethernet 1

RS232 1

IR Input/Output 1/1

12 V Trigger Out 1

USB Yes (1)

Specifications and features are subject to change without notice.

ONKYO CORPORATION

Sales & Product Planning Div. : 2-1, Nisshin-cho, Neyagawa-shi, OSAKA 572-8540, JAPAN
Tel: 072-831-8023 Fax: 072-831-8163

ONKYO U.S.A. CORPORATION

18 Park Way, Upper Saddle River, N.J. 07458, U.S.A.
Tel: 201-785-2600 Fax: 201-785-2650 <http://www.us.onkyo.com/>

ONKYO EUROPE ELECTRONICS GmbH

Liegnitzerstrasse 6, 82194 Groebenzell, GERMANY
Tel: +49-8142-4401-0 Fax: +49-8142-4401-555 <http://www.eu.onkyo.com/>

ONKYO EUROPE UK Office

Suite 1, Gregories Court, Gregories Road, Beaconsfield, Buckinghamshire, HP9 1HQ
UNITED KINGDOM Tel: +44-(0)1494-681515 Fax: +44(0)-1494-680452

ONKYO CHINA LIMITED

Unit 1&12, 9/F, Ever Gain Plaza Tower 1, 88, Container Port Road, Kwai Chung,
N.T., HONG KONG Tel: 852-2429-3118 Fax: 852-2428-9039
<http://www.ch.onkyo.com/>



Y0807-2

SN 29344753A

(C) Copyright 2008 ONKYO CORPORATION Japan. All rights reserved.



* 2 9 3 4 4 7 5 3 A *