

# Basic Manual

## Hookup

Step1: Speaker Layout .....	3
Step2: Connect the Speakers .....	9
Step3: Connect the TV .....	11
Step4: Connect the AV Components .....	13
Step5: Multi-zone Connection .....	17
Step6: Connect Other Cables .....	20

## Setup

Step7: Power On & Initial Setup .....	21
HDMI Setup .....	22

## Playback

Basic Playback .....	23
Network Functions .....	24
Others .....	26

## Part Names

Front Panel .....	29
Display .....	30
Rear Panel .....	31
Remote Controller .....	32

This manual includes information needed when starting up and also instructions for frequently used operations. The "Advanced Manual" is available on the internet with details about the playback features/ listening modes/settings details, specifications, and troubleshooting. The Advanced Manual is created in a format that makes it easy to read on a PC or Smartphone.

AV RECEIVER  
**TX-RZ1100**  
**ONKYO**

<http://www.onkyo.com/manual/txrz1100/adv/en.html>  
Advanced Manual found here



## What's in the box

1. Main unit
2. Remote controller (RC-926R) ×1, Batteries (AA/R6) ×2
3. Indoor FM antenna ×1
4. AM loop antenna ×1
5. Speaker setup microphone ×1
6. Power cord ×1

## Glossary

### Dolby Atmos

This unit supports playback in the Dolby Atmos format which provides 360° sound placement. Unlike existing surround systems, Dolby Atmos doesn't rely on channels, but rather enables the accurate placement of sound objects that have independent motion in a three-dimensional space with even greater clarity. Dolby Atmos is an optional audio format on Blu-ray Discs and achieves a three-dimensional sound field by introducing a sound field above the listener.

### ARC

The ARC (Audio Return Channel) feature transfers TV audio signals via HDMI cable so that you can play the audio from the TV through this unit. Connection to an ARC compatible TV is complete with one HDMI cable. Refer to the instruction manual for your TV to see if it supports ARC. (→P11)

### HDMI CEC functionality

Control features such as linking input switching with the input selector and players conforming to the CEC standard, switching audio output and volume using the remote controller of a CEC-compliant TV, and automatically switching this unit to standby when the TV is turned off (→P13)

### HDMI Standby Through

Video and audio signals from AV components can be transmitted to the TV even if this unit is in standby (→P13)

---

**i CAUTION:** Connect speakers with 4 Ω to 16 Ω impedance. The power cord must be connected only after all other cable connections are completed. We will not accept responsibility for damage arising from the connection of equipment manufactured by other companies.

---

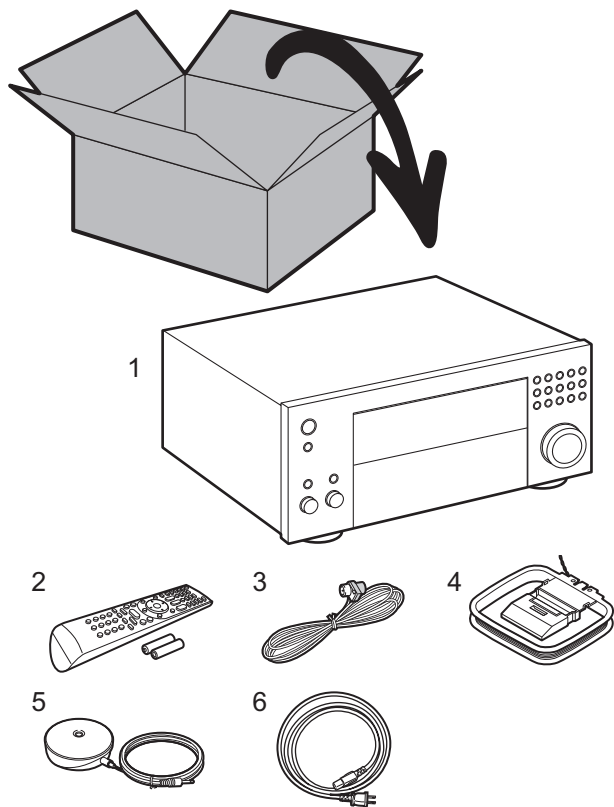

## Step1: Speaker Layout

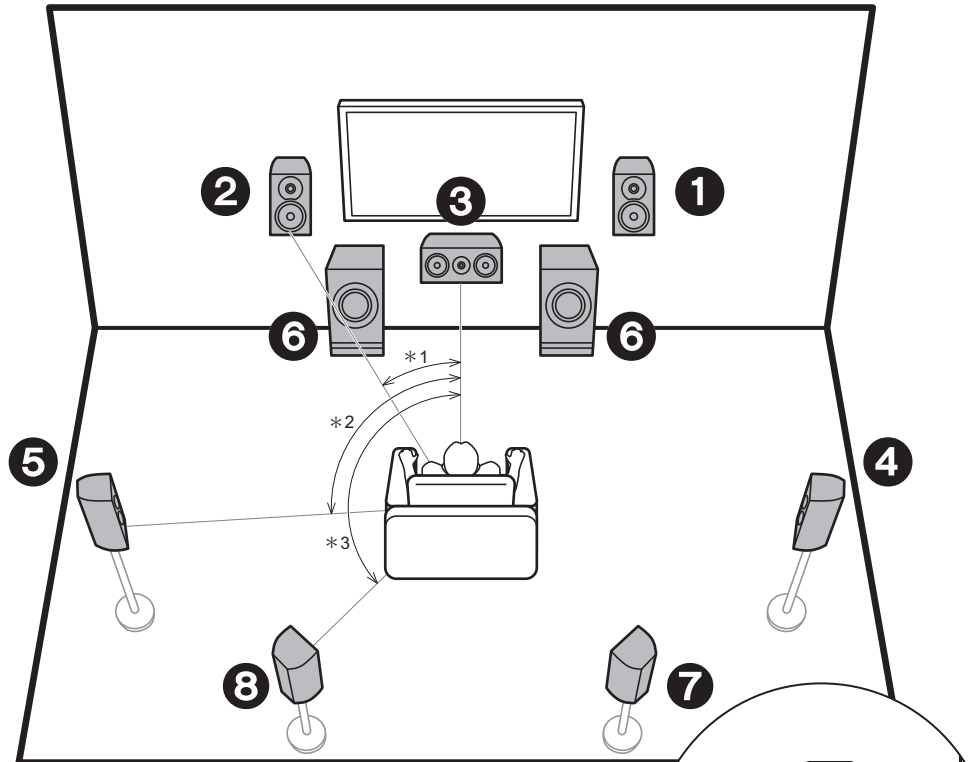

\* 1: 22° ~ 30°, \* 2: 90° ~ 120°, \* 3: 135° ~ 150°

- ① ② Front Speakers
- ③ Center Speaker
- ④ ⑤ Surround Speakers
- ⑥ Powered Subwoofer
- ⑦ ⑧ Surround Back Speakers

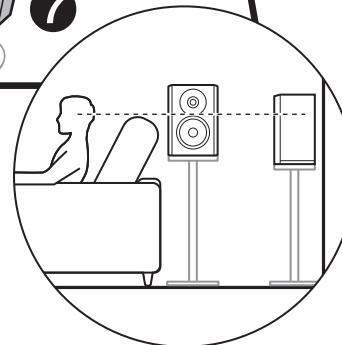

### ✓ 7.1-Channel System

Front speakers output front stereo sound and a center speaker outputs center sound such as dialogs and vocals. Surround speakers create back sound field. Powered subwoofer reproduces bass sounds and creates rich sound field.

Surround back speakers improve the sense of envelopment created by the back sound field and provide a more realistic sound field. Furthermore, by installing surround back speakers, you can select the Dolby Atmos listening mode, which realizes the most up-to-date 3D sound, when the input format is Dolby Atmos.

The front speakers should be positioned at ear height, while the surround speakers should be positioned just above ear height. Center speaker should be set up facing the listening position.

Placing the powered subwoofer between the center speaker and a front speaker gives you a natural sound even when playing music.

The optimal positioning is for surround back speakers to be at ear height.

- If you are including surround back speakers in the setup, surround speakers are required.

 Go To "Hookup" (→P9)

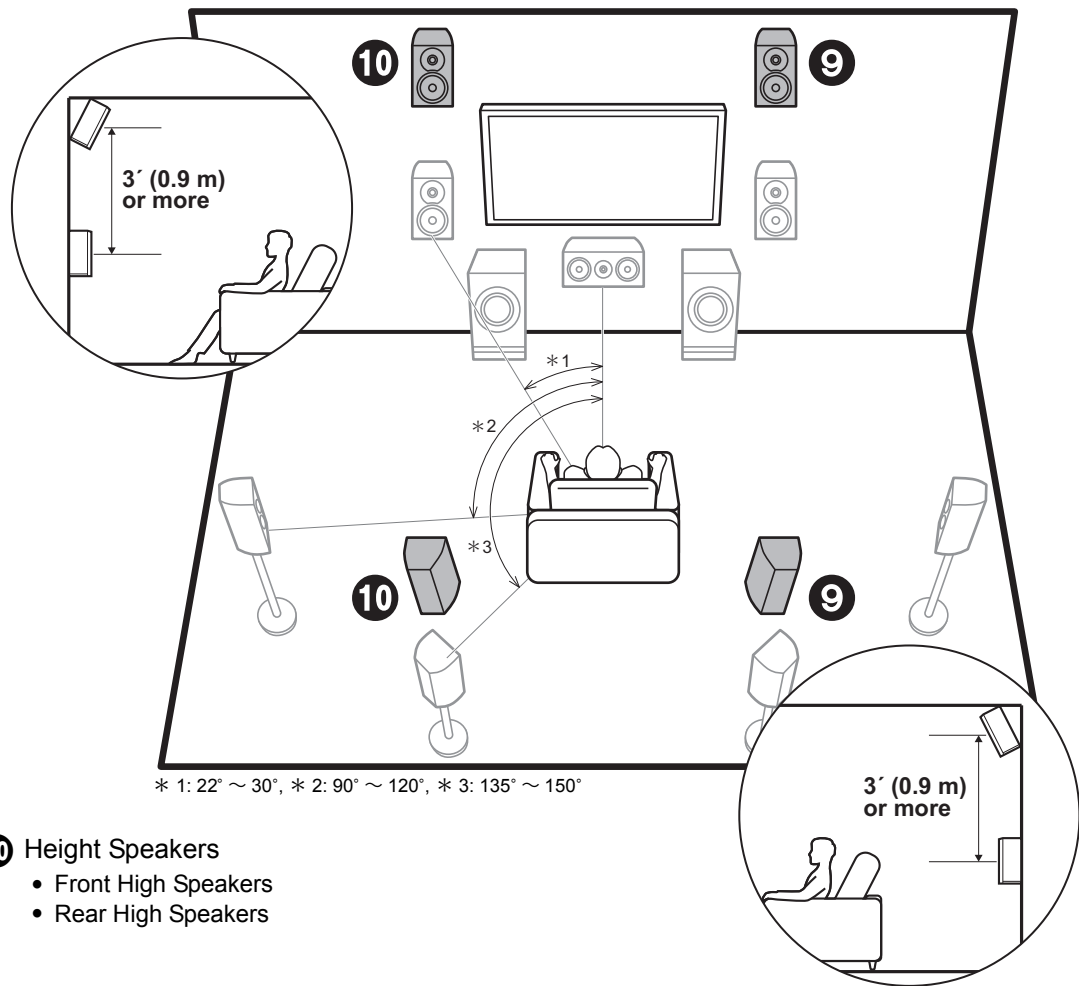

- 9 10** Height Speakers
- Front High Speakers
  - Rear High Speakers

✓ **Height Speakers;  
Front High Speakers/  
Rear High Speakers**

These are types of height speakers. Furthermore, by installing height speakers, you can select the Dolby Atmos listening mode, which realizes the most up-to-date 3D sound including overhead sounds, when the input format is Dolby Atmos.

Front high speakers or rear high speakers should be situated at least 0.9 m higher than the front speakers. Front high speakers should be situated directly above the front speakers and the distance between the rear high speakers should match the distance between the front speakers. Both should be set up facing the listening position. Note that with height speakers you can install up to two sets; Height 1 Speaker and Height 2 Speaker.

 Go To "Hookup" (➔P9)

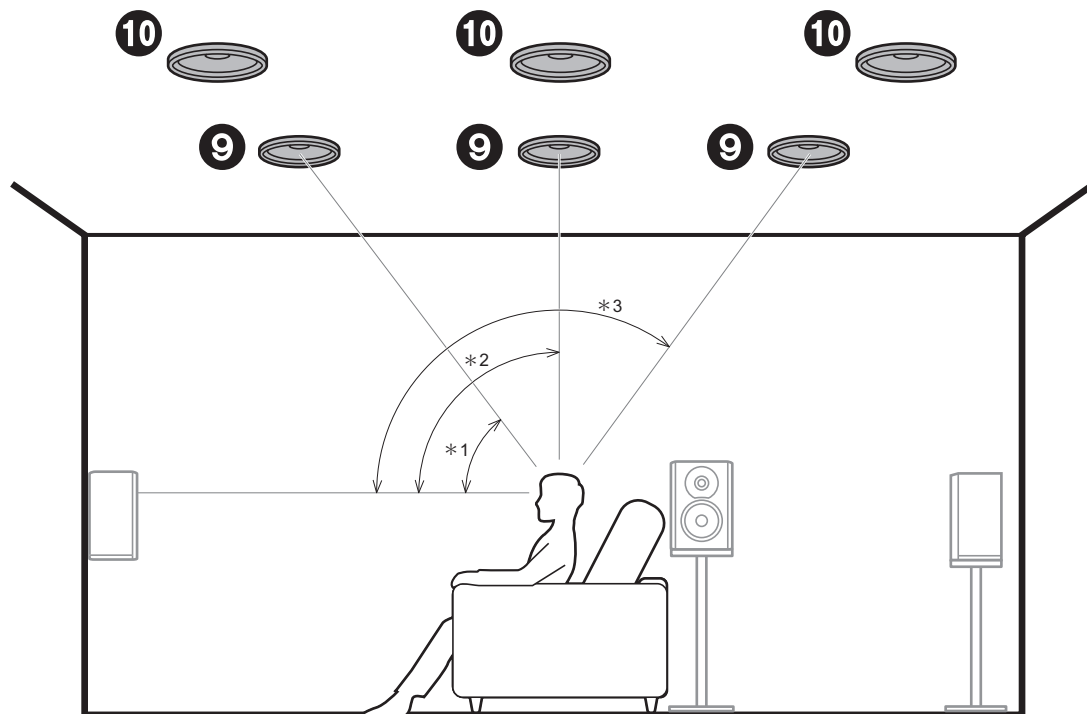

\* 1: 30° ~ 55°, \* 2: 65° ~ 100°, \* 3: 125° ~ 150°

**9 10** Height Speakers

- Top Front Speakers
- Top Middle Speakers
- Top Rear Speakers

**Height Speakers;  
Ceiling Speakers**

These are types of height speakers. Furthermore, by installing height speakers, you can select the Dolby Atmos listening mode, which realizes the most up-to-date 3D sound including overhead sounds, when the input format is Dolby Atmos.

Fit top front speakers on the ceiling forward of the seating position, top middle speakers on the ceiling directly above the seating position, and top rear speakers on the ceiling behind the seating position. The distance between each pair should match the distance between the two front speakers. Note that with height speakers you can install up to two sets; Height 1 Speaker and Height 2 Speaker.

- Dolby Laboratories recommends placing this type of height speakers to obtain the best Dolby Atmos effect.

 Go To "Hookup" (➔P9)

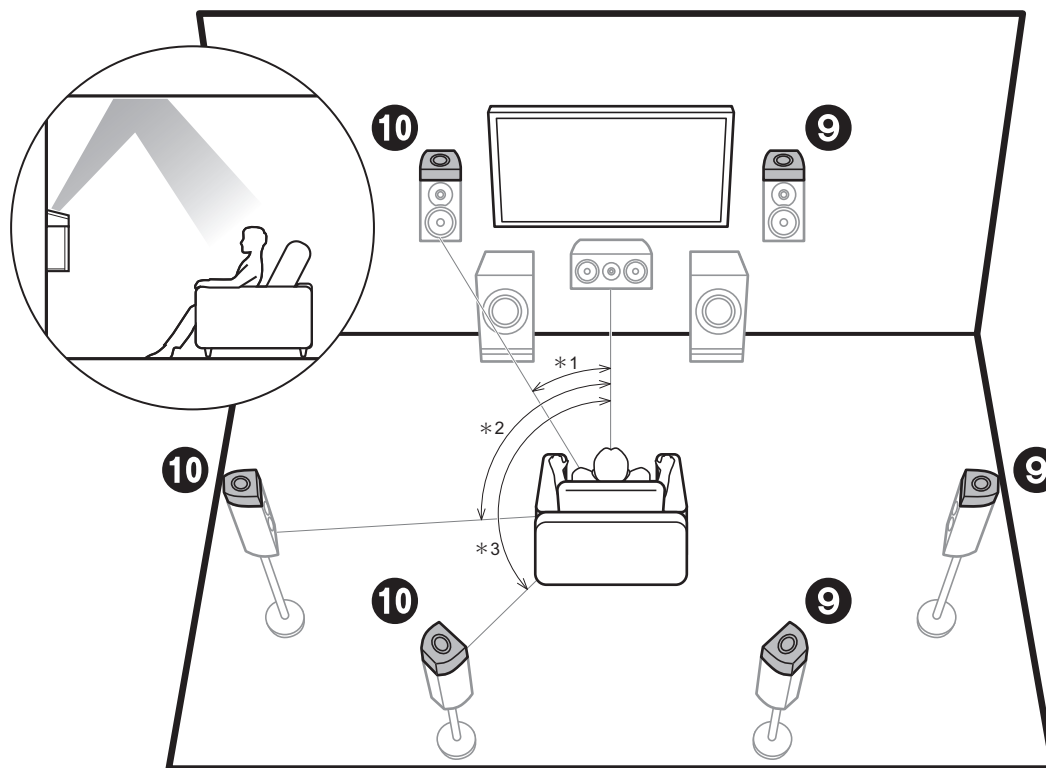

\* 1: 22° ~ 30°, \* 2: 90° ~ 120°, \* 3: 135° ~ 150°

✓ **Height Speakers;  
Dolby Enabled Speakers  
(Dolby Speakers)**

These are types of height speakers. Dolby enabled speakers are special speakers designed to face the ceiling so that sound is heard after bouncing off the ceiling so that sound appears to be coming from overhead. Furthermore, by installing height speakers, you can select the Dolby Atmos listening mode, which realizes the most up-to-date 3D sound including overhead sounds, when the input format is Dolby Atmos. Place them either above the front speakers or above the surround speakers or surround back speakers. Note that with height speakers you can install up to two sets; Height 1 Speaker and Height 2 Speaker.

 Go To "Hookup" (→P9)

**9 10** Height Speakers

- Dolby Enabled Speakers (Front)
- Dolby Enabled Speakers (Surround)
- Dolby Enabled Speakers (Surround Back)

## ✓ Bi-Amping the Speakers

It is possible to connect front speakers supporting Bi-Amping to improve quality of the bass and treble. The effects and placements for speakers are the same as for a system that doesn't use Bi-Amping speakers.

 Go To "Hookup" (→P10)

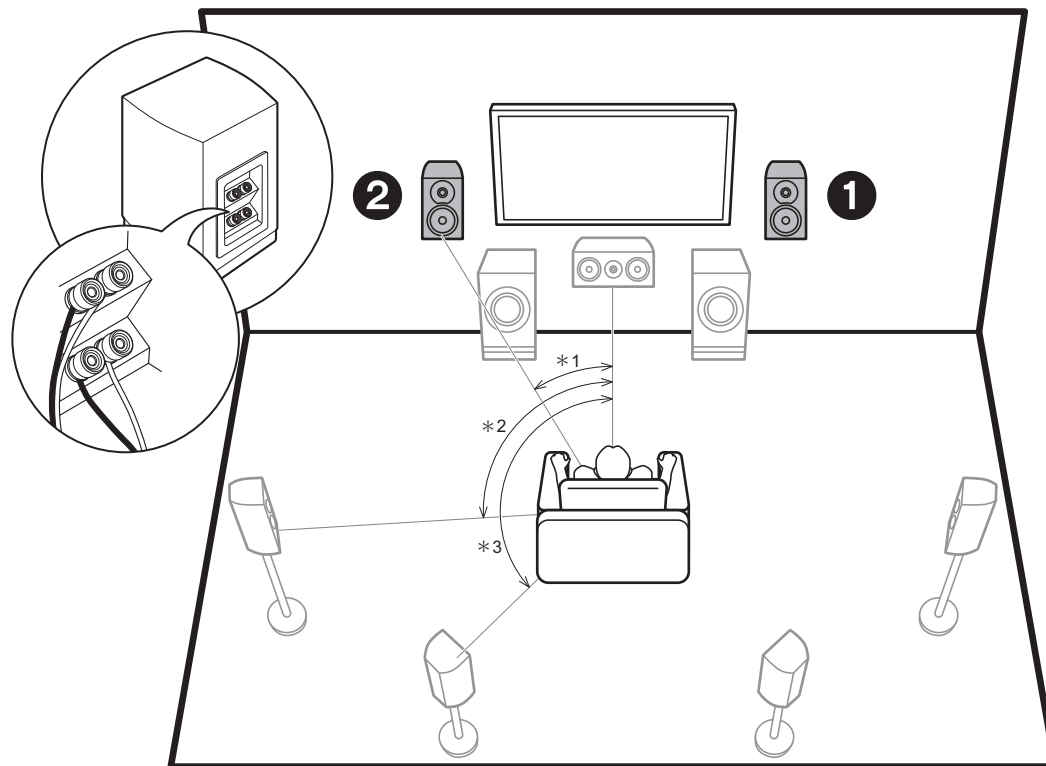

\* 1: 22° ~ 30°, \* 2: 90° ~ 120°, \* 3: 135° ~ 150°

### 1 2 Front Speakers (Bi-Amping)

## ✓ Speaker combinations

In any of the combinations, up to two powered subwoofers can be connected.

Speaker Channels	FRONT	CENTER	SURROUND	SURROUND BACK	HEIGHT 1	HEIGHT 2	Bi-AMP * 1	ZONE 2 * 1 (→P18)	ZONE 3 * 1 (→P19)
2.1 ch	✓						✓	✓	✓
3.1 ch	✓	✓					✓	✓	✓
4.1 ch	✓		✓				✓	✓	✓
5.1 ch	✓	✓	✓				✓	✓	✓
6.1 ch	✓		✓	✓			✓	✓ * 2	✓
7.1 ch	✓	✓	✓	✓			✓	✓ * 2	✓
2.1.2 ch	✓				✓ * 3		✓	✓	✓ * 4
3.1.2 ch	✓	✓			✓ * 3		✓	✓	✓ * 4
4.1.2 ch	✓		✓		✓ * 3		✓	✓	✓ * 4
5.1.2 ch	✓	✓	✓		✓ * 3		✓	✓	✓ * 4
6.1.2 ch	✓		✓	✓	✓ * 5		✓	✓	
7.1.2 ch	✓	✓	✓	✓	✓ * 5		✓	✓	
4.1.4 ch	✓		✓		✓	✓			
5.1.4 ch	✓	✓	✓		✓	✓			
6.1.4 ch	✓		✓	✓ * 6	✓	✓			
7.1.4 ch	✓	✓	✓	✓ * 6	✓	✓			

### Points to note with speaker combinations

- \* 1: It is not possible to use Bi-AMP and ZONE speakers at the same time. However, with 2.1 ch to 7.1 ch, it is possible to use Bi-AMP and ZONE 2 speakers at the same time.
- \* 2: If you have not connected ZONE 3 speakers in another room but have only connected ZONE 2 speakers, connect the ZONE 2 speakers to the HEIGHT 1 jacks. However, if Bi-Amping connections are used for front speakers, connect the ZONE 2 speakers to the HEIGHT 2 jacks.
- \* 3: If front speakers are to be Bi-Amping connected, height speakers need to be connected to the HEIGHT 2 jacks.
- \* 4: ZONE 2 speakers need to be connected to the HEIGHT 1 jack, ZONE 3 speakers need to be connected to the SURROUND BACK jacks, and height speakers need to be connected to the HEIGHT 2 jacks.
- \* 5: This unit consists of a 9 ch amplifier, so when using a Bi-Amping connection for the front speakers, use an RCA cable to connect the power amplifier to the PRE OUT HEIGHT 2 jacks, then connect the height speakers to the power amplifier.
- \* 6: This unit consists of a 9 ch amplifier, so with this combination use an RCA cable to connect the power amplifier to the PRE OUT BACK jacks, then connect the surround back speakers to the power amplifier.

### HEIGHT 1/HEIGHT 2

- When connecting 2 sets of height speakers, the height speaker combinations you can choose are as follows.
- Height 1 Speaker: Top Middle, Height 2 Speaker: Rear High
  - Height 1 Speaker: Front High, Height 2 Speaker: One of Rear High/Top Middle/Top Rear/Dolby Enabled Speaker (Surround)/Dolby Enabled Speaker (Surround Back)
  - Height 1 Speaker: Top Front or Dolby Enabled Speaker (Front), Height 2 Speaker: One of Rear High/Top Rear/Dolby Enabled Speaker (Surround)/Dolby Enabled Speaker (Surround Back)
- When connecting only one set of height speakers, select one type of height speakers from the types available.



## Step2: Connect the Speakers

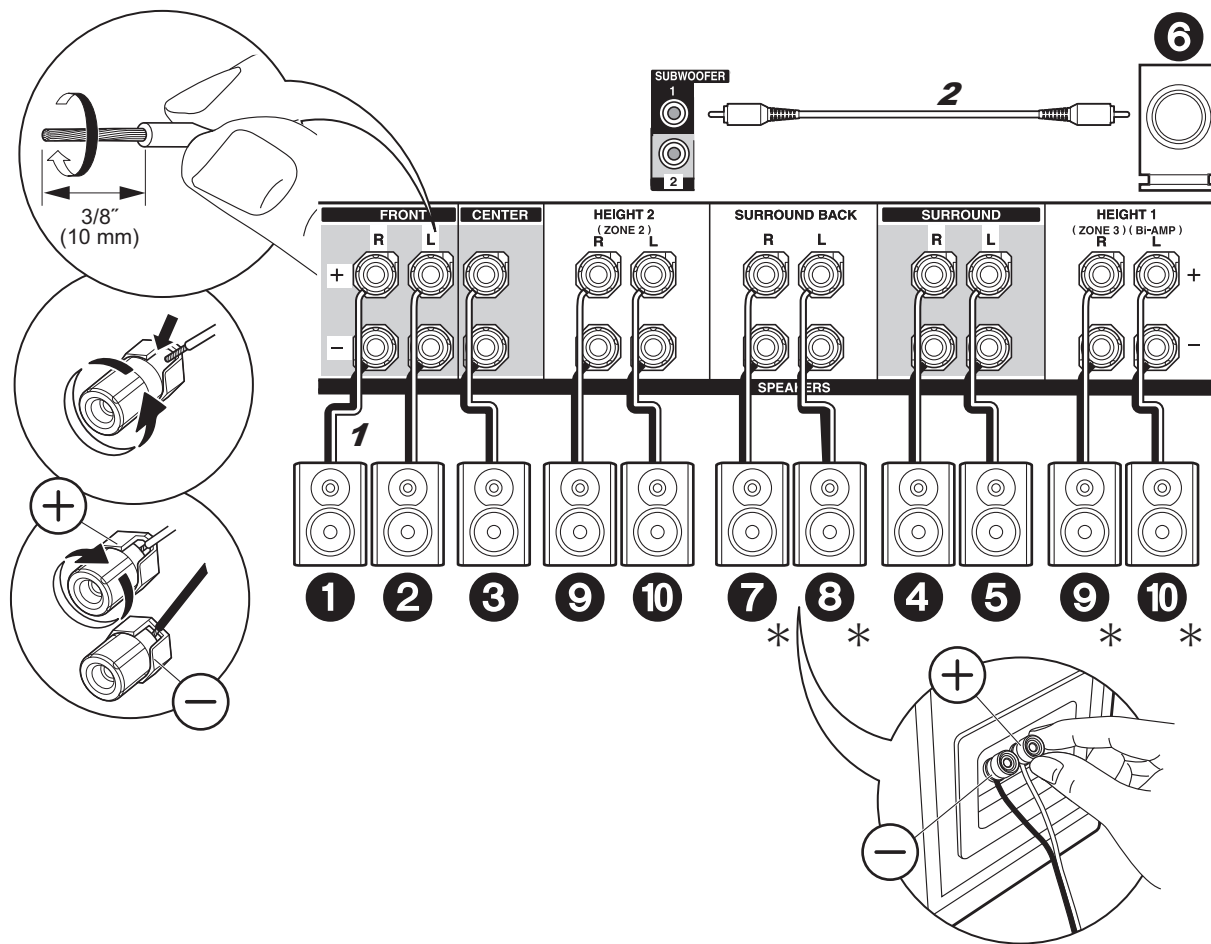

### ✓ Standard Connections

Refer to the illustration to connect the speaker system.  
 \* Depending on the combination of speakers, you may need to connect to other jacks. See "Points to note with speaker combinations" (→P8) for details.

Make sure the exposed wires of the speakers do not stick out of the speaker terminals when connecting. If the exposed wires of the speakers touch the rear panel or the + and - wires touch each other, the protection circuit will be activated.

1 Speaker cable, 2 Subwoofer cable

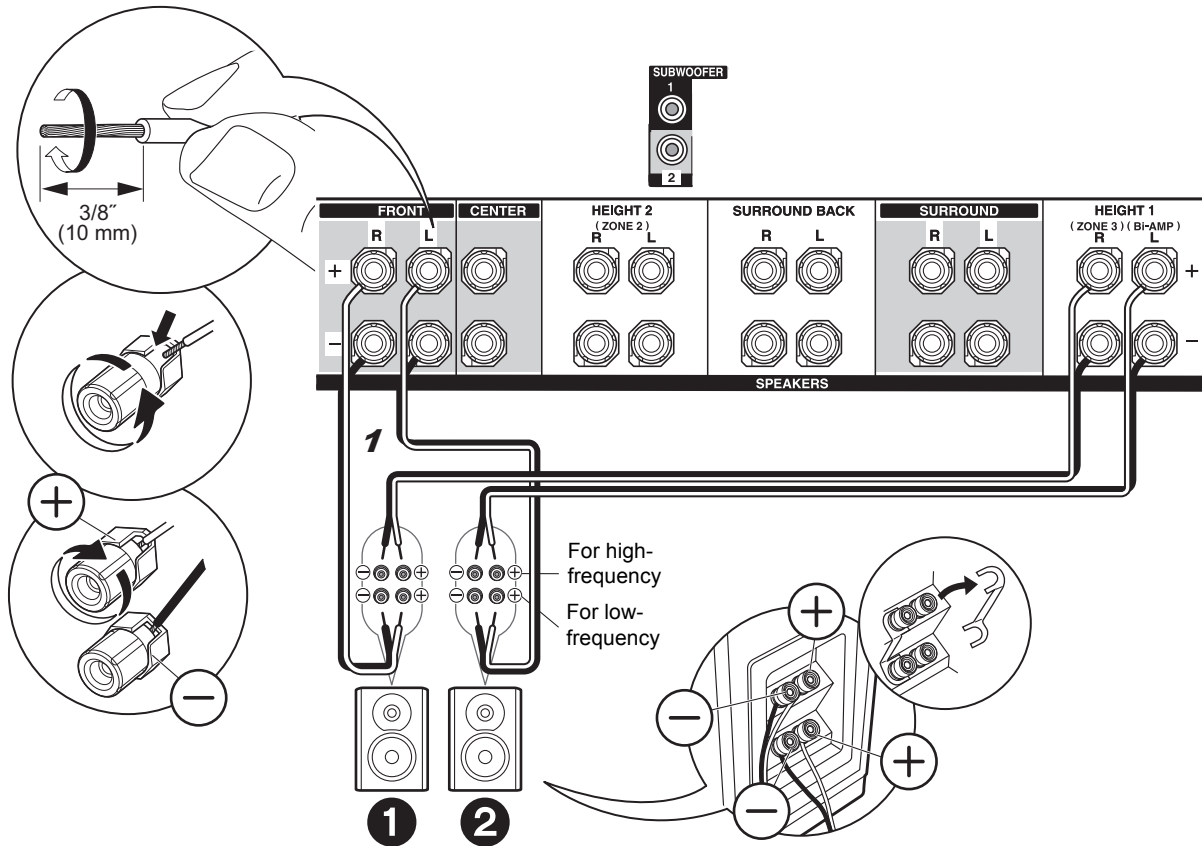

## ✓ Connections with Bi-Amping speakers

Connect front speakers compatible with Bi-Amping connection to the FRONT jacks and the HEIGHT 1 jacks. Make sure you remove the jumper bar fitted between the woofer jacks and tweeter jacks of the front speakers. In case of Bi-Amping connection, refer to the instruction manual of your speakers.

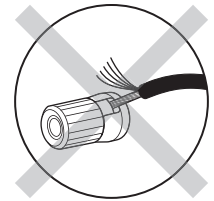

Make sure the exposed wires of the speakers do not stick out of the speaker terminals when connecting. If the exposed wires of the speakers touch the rear panel or the + and - wires touch each other, the protection circuit will be activated.

## Step3: Connect the TV

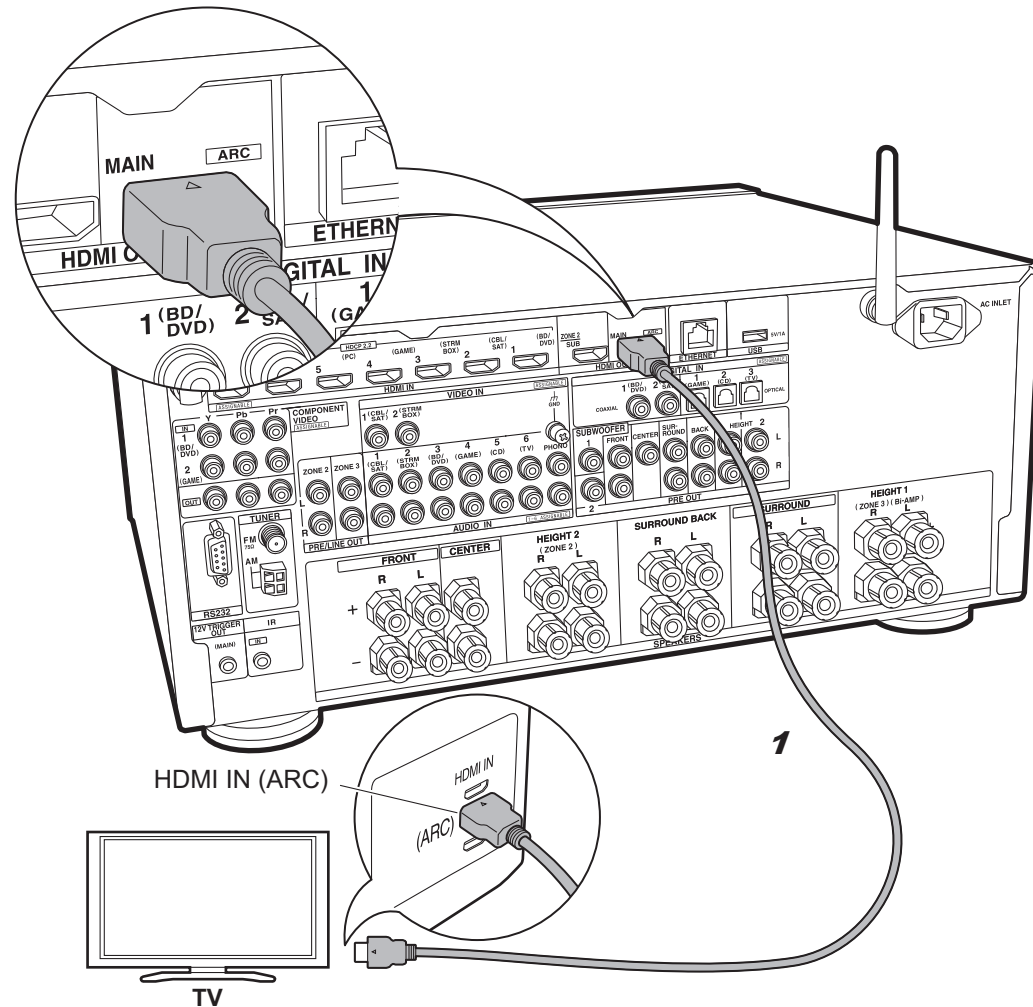

1 HDMI cable

### ✓ TV-1 (ARC TV)

This describes the connections for a TV that supports the ARC (Audio Return Channel) feature. By connecting with a single HDMI cable, you can not only output the video input to this unit to the TV, but you can also play the sound from the TV through this unit. Choose an HDMI IN jack on the TV that supports ARC when connecting.



#### Setup

- Settings are required to use the ARC function. Select "Yes" in "5. Audio Return Channel" (→P22) in the Initial Setup.
- Please refer to the TV's operation manual for directions on connections and setup for the TV.

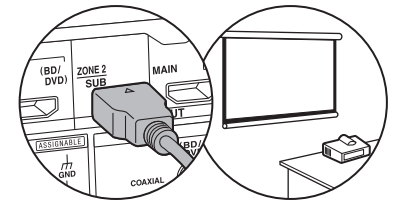

Another TV or projector can be connected to the HDMI OUT SUB jack. This jack does not support ARC. For details about how to output video from the HDMI OUT SUB jack (→P23)

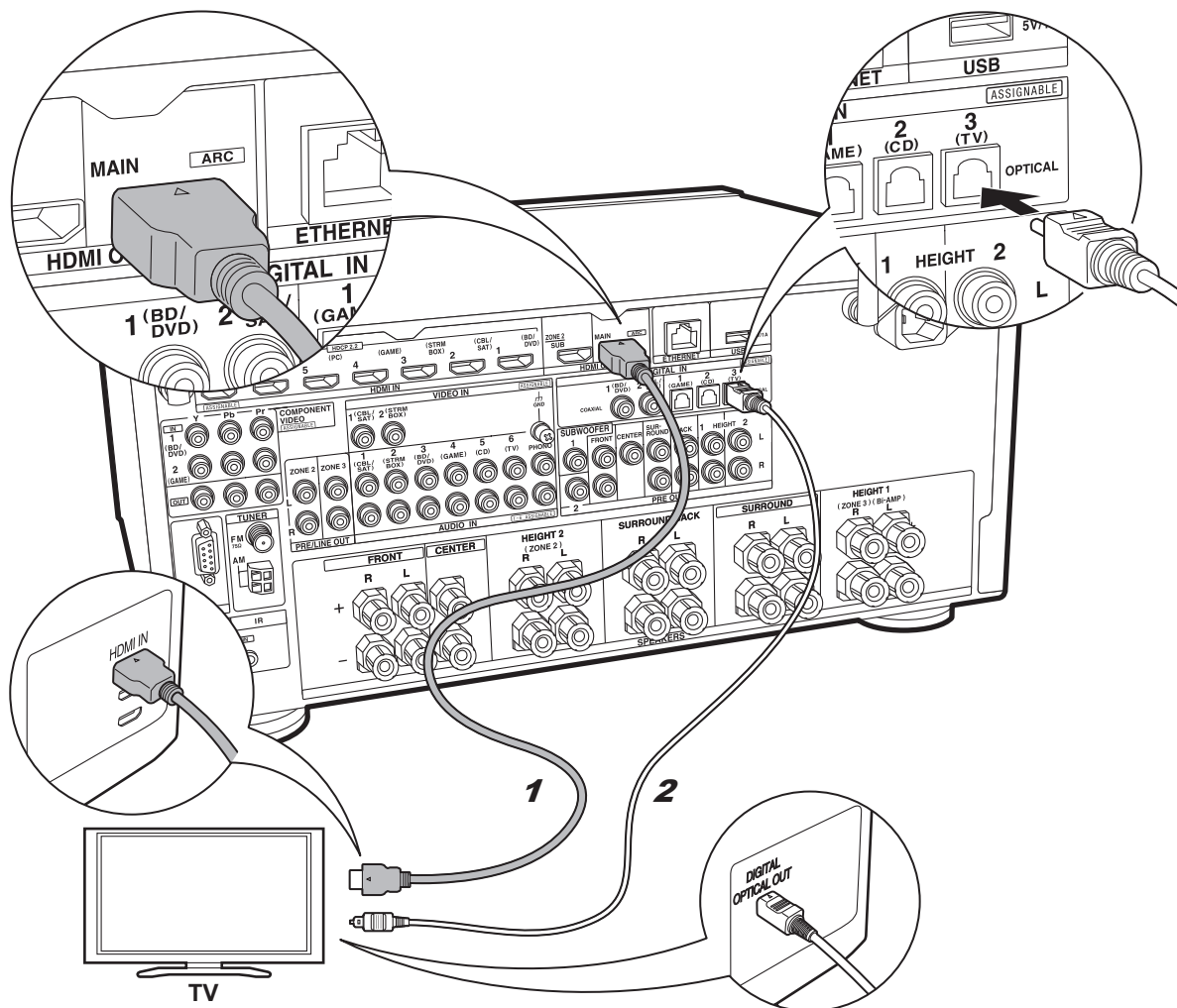

1 HDMI cable, 2 Digital optical cable

## ✓ TV-2 (Non-ARC TV)

This describes the connections for a TV that does not support the ARC (Audio Return Channel) feature. By connecting with both an HDMI cable and a digital optical cable, you can not only output the video input to this unit to the TV, but you can also play the sound from the TV through this unit.

If the TV doesn't have a DIGITAL OPTICAL OUT jack, use an analog audio cable and connect the TV's ANALOG AUDIO OUT jack to the AUDIO IN TV jack on this unit.

- Connection with a digital optical cable is not necessary if you will watch TV through a device such as a cable set-top box (that is, not use a tuner built into the TV) that you have connected to the INPUT jack on this unit.

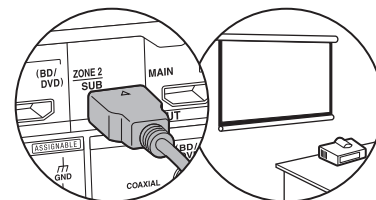

Another TV or projector can be connected to the HDMI OUT SUB jack. This jack does not support ARC. For details about how to output video from the HDMI OUT SUB jack (→P23)

## Step4: Connect the AV Components

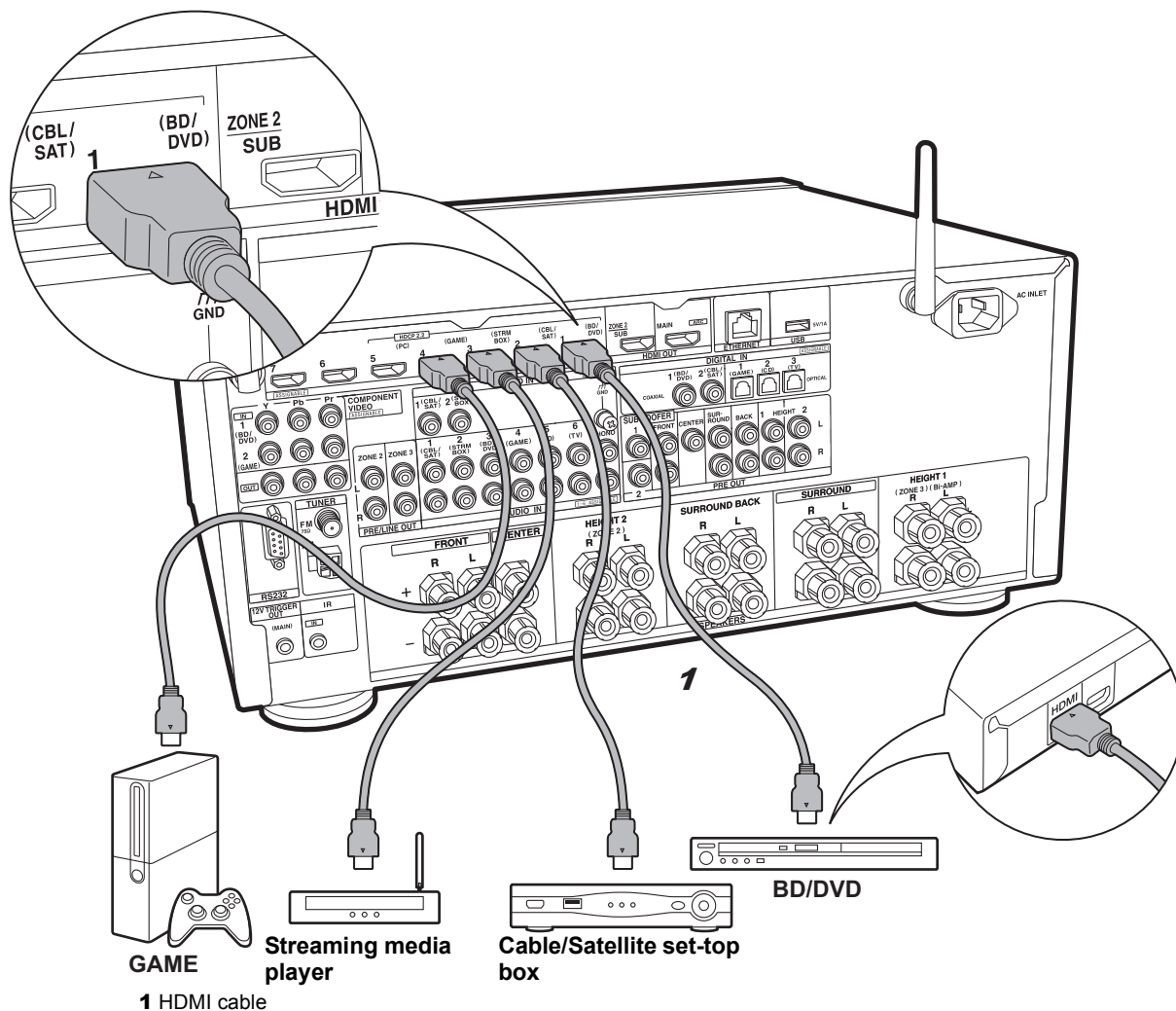

### ✓ HDMI AV Components

This is an example of connection with an AV component that has an HDMI jack. With connection to an AV component that conforms with the CEC (Consumer Electronics Control) standard, you can use features such as the HDMI CEC feature that links with the input selector, and the HDMI Standby Through feature which allows you to play video and audio from AV components on the TV even when this unit is in standby mode.

- To play 4K or 1080p video, use a high speed HDMI cable. Further, to enjoy HDCP2.2 compatible video, connect to the HDMI IN1 to IN5 jacks.



#### Setup

- HDMI setup (→P22) is required to use the HDMI CEC and HDMI Standby Through features. Make settings after all connections are complete.
- To enjoy digital surround sound including Dolby Digital, audio output should be set to "Bitstream output" on the connected Blu-ray Disc player or other device.

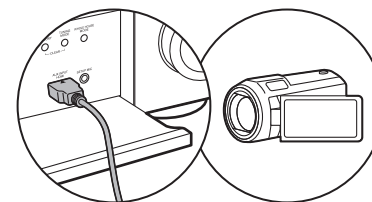

You can connect a device such as a video camera to the AUX INPUT HDMI jack on the front panel.

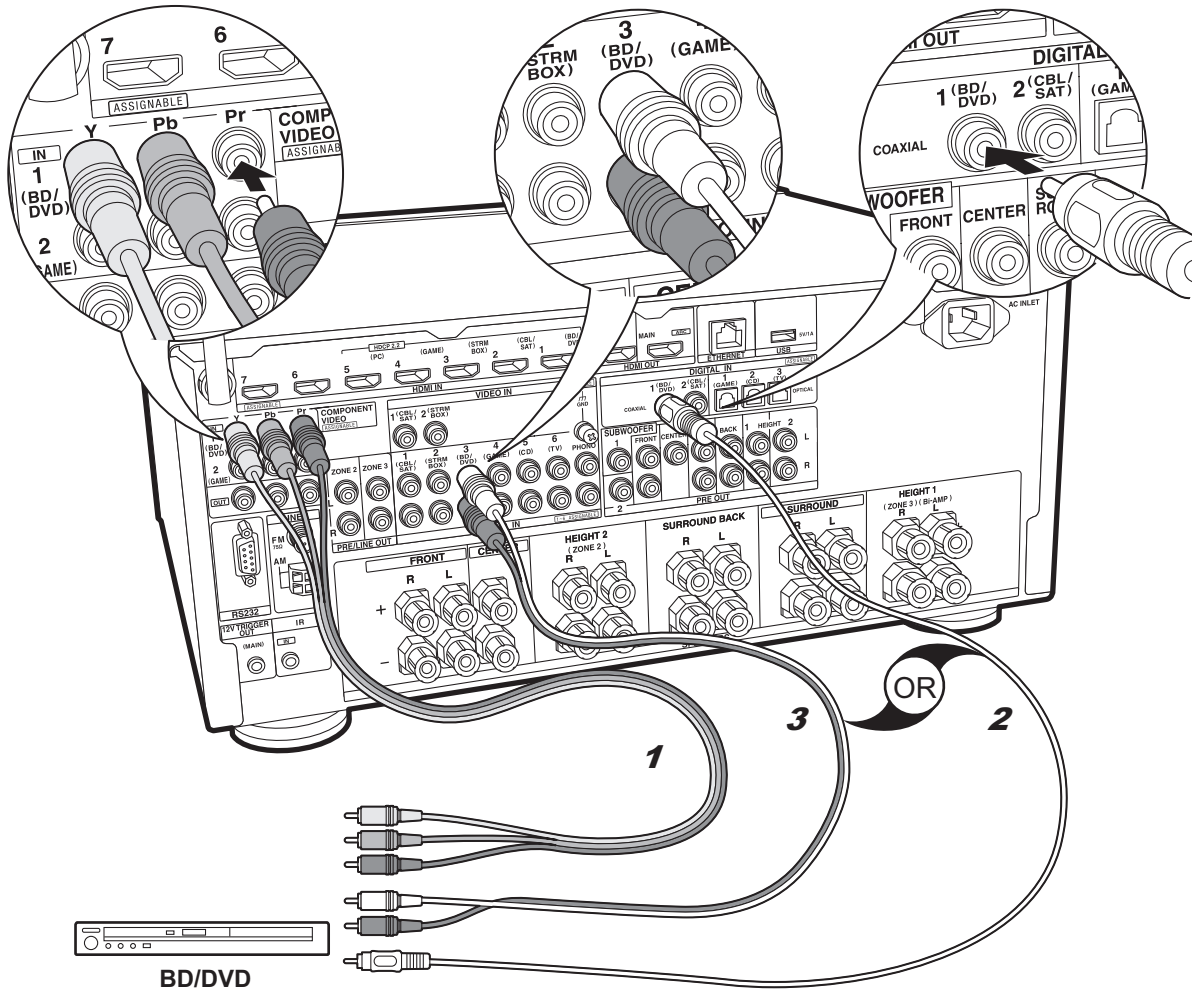

## ✓ Non-HDMI AV Components

This is an example of connection with an AV component that does not have an HDMI jack. Make the connections to the AV component to match the jacks it has. When video input connection is to the BD/DVD jack, the audio input connection should also be to the BD/DVD jacks, and so on, so that you connect the video input jacks to the jacks with the same name as the audio input jacks. Note that video signals input to the VIDEO IN jack or the COMPONENT VIDEO IN jacks will be converted to HDMI video signals and then output from the HDMI OUT jack.

- To enjoy digital surround playback in formats such as Dolby Digital, you need to make a connection for audio signals with a digital coaxial cable or digital optical cable.
- It is possible to change assignment of the input jacks you see in the illustration at left, so you can also connect to any jack other than BD/DVD. For details, see the Advanced Manual.

### ⚙️ Setup

- The COMPONENT VIDEO IN jacks are compatible only with 480i or 576i resolution. When you input video signals to the COMPONENT VIDEO IN jacks, set the output resolution of the player to 480i or 576i. Select interlace if there is no option for 480i, etc. If your player does not support 480i or 576i output, use the VIDEO IN jack.
- To enjoy digital surround sound including Dolby Digital, audio output should be set to "Bitstream output" on the connected Blu-ray Disc Player or other device.

1 Component video cable, 2 Digital coaxial cable, 3 Analog audio cable



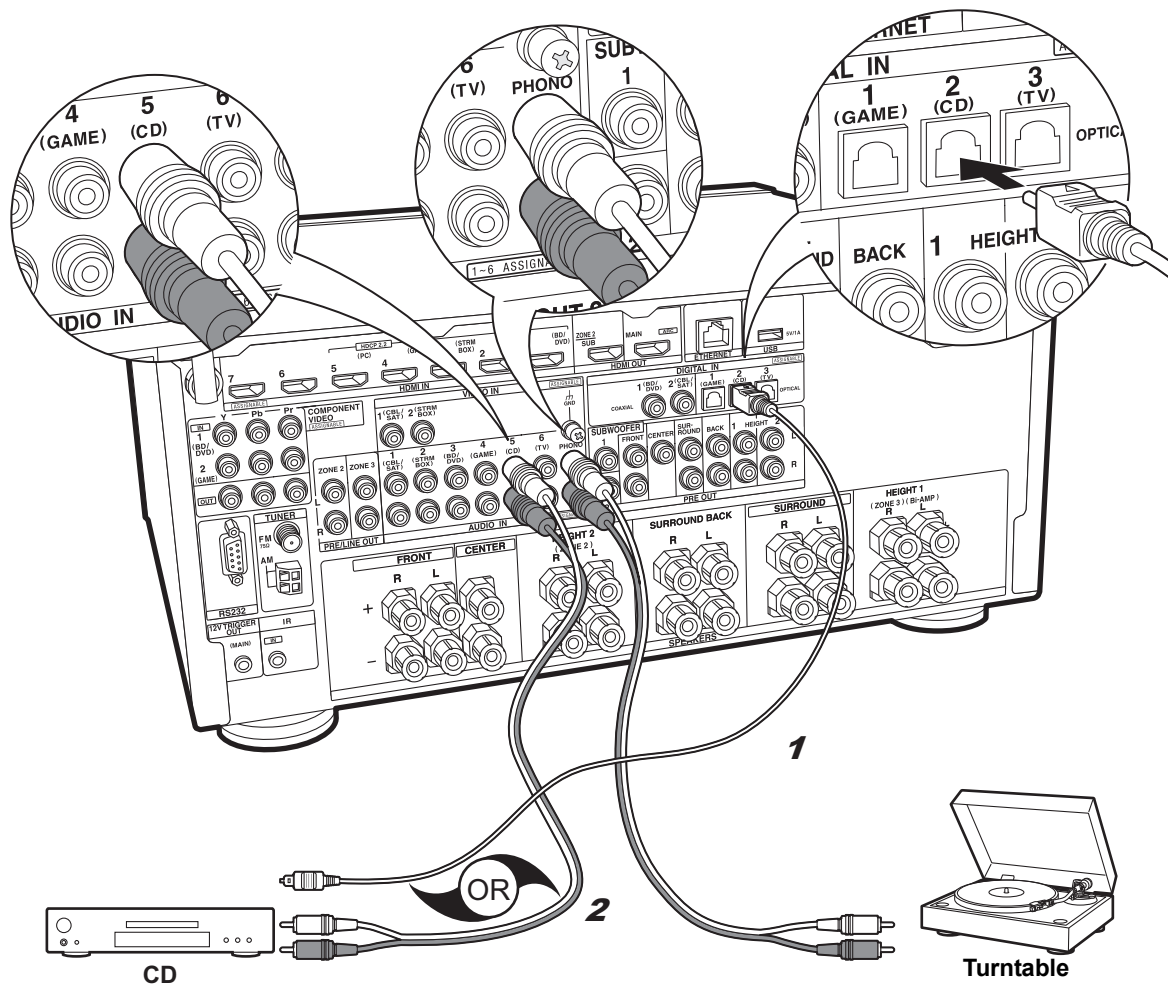

1 Digital optical cable, 2 Analog audio cable

## ✓ Audio Components

Example of a connection with an Audio Component. Connect a CD player using a digital optical cable or analog audio cable. You can also connect a turntable that has an MM-type cartridge to the PHONO jack.

- If the turntable has a built-in audio equalizer, connect it to an AUDIO IN jack other than the PHONO jack. Further, if the turntable uses an MC type cartridge, install an audio equalizer compatible with the MC type cartridge between the unit and the turntable, then connect to any AUDIO IN jack other than the PHONO jack.

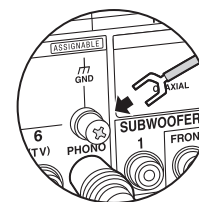

If the turntable has a ground wire, connect it to the GND terminal of this unit.

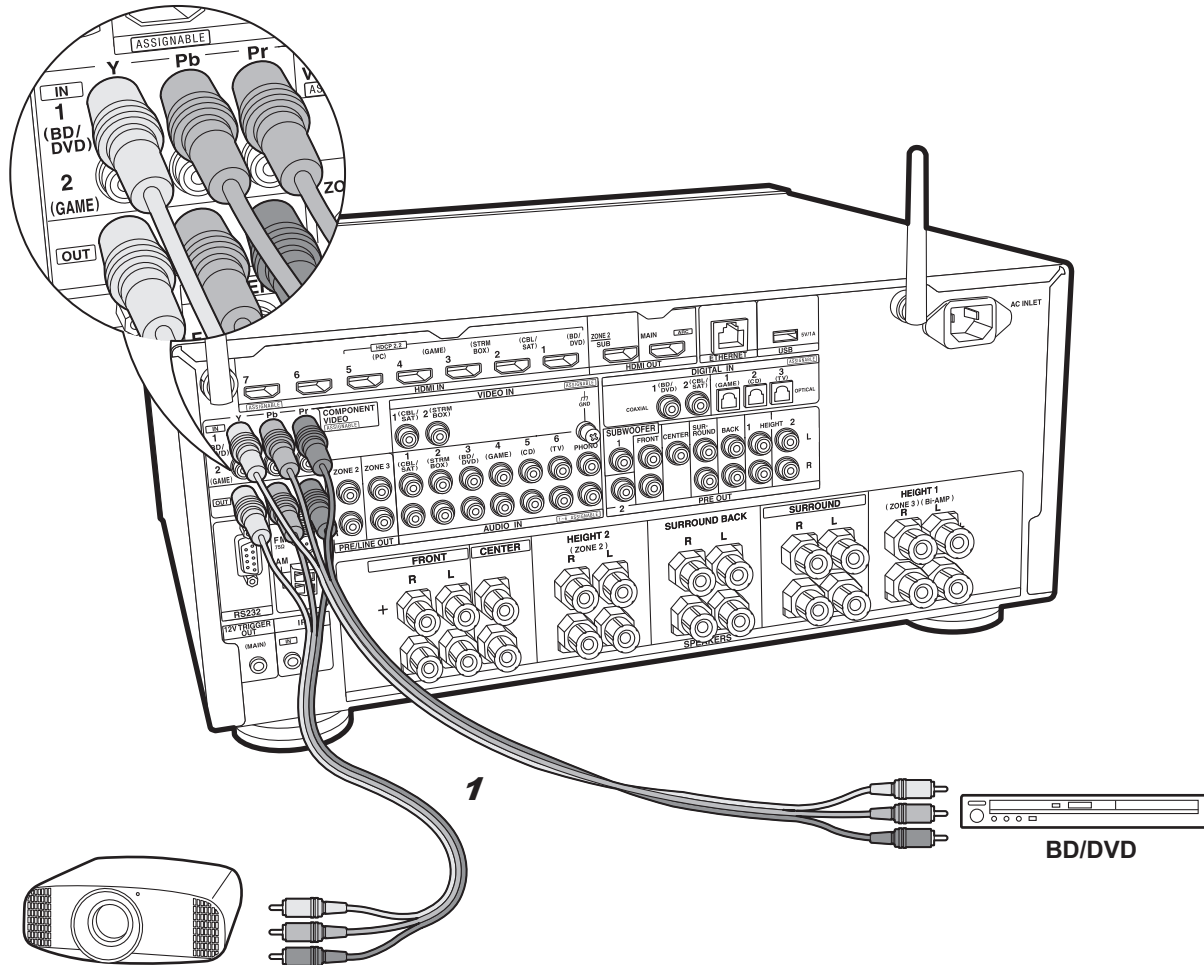

**Component Video Monitor**

Use a component video cable to connect a TV or projector that has component video input jacks rather than an HDMI input jack. To output video from the COMPONENT VIDEO OUT jacks, you must connect the external AV components using a component video cable.

Projector, etc.

1 Component video cable



## Step5: Multi-zone Connection

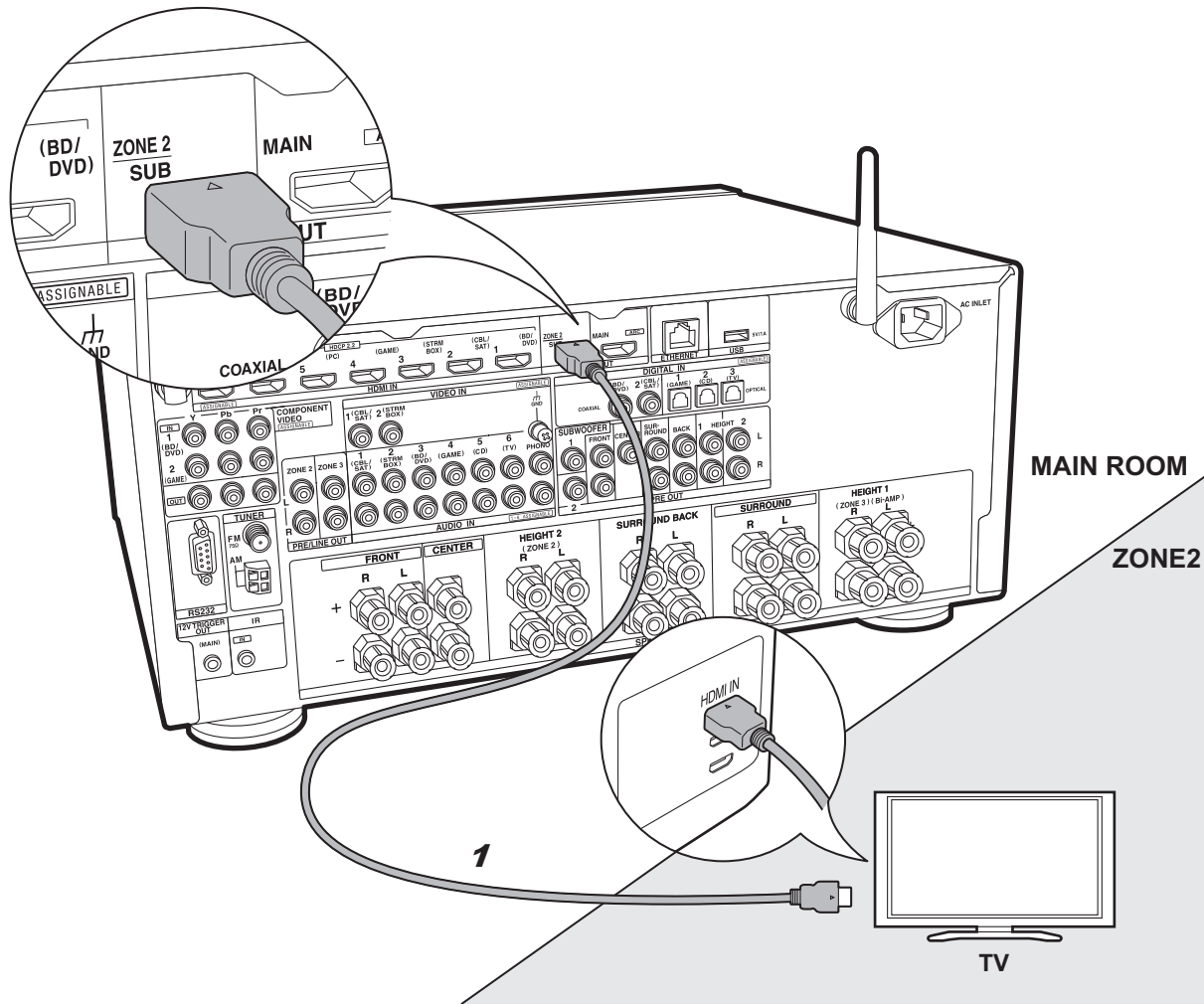

1 HDMI cable

### ✓ ZONE 2 TV

You can enjoy content from a Blu-ray Disc player on a TV equipped with an HDMI input jack in the separate room (ZONE 2) by playing a Blu-ray Disc player in the main room (where this unit is located), or play the content from another AV component. Only the video from devices connected to the HDMI IN1 to IN5 jacks can be played on the TV in the separate room.



#### Setup

- Settings are required in Initial Setup, "4. Multi Zone Setup" (→P22) to enjoy this feature.
- The audio from externally connected AV components can only be played in ZONE 2 when the audio is analog or 2ch PCM audio. It may also be necessary to convert the audio output of the AV component to PCM output.

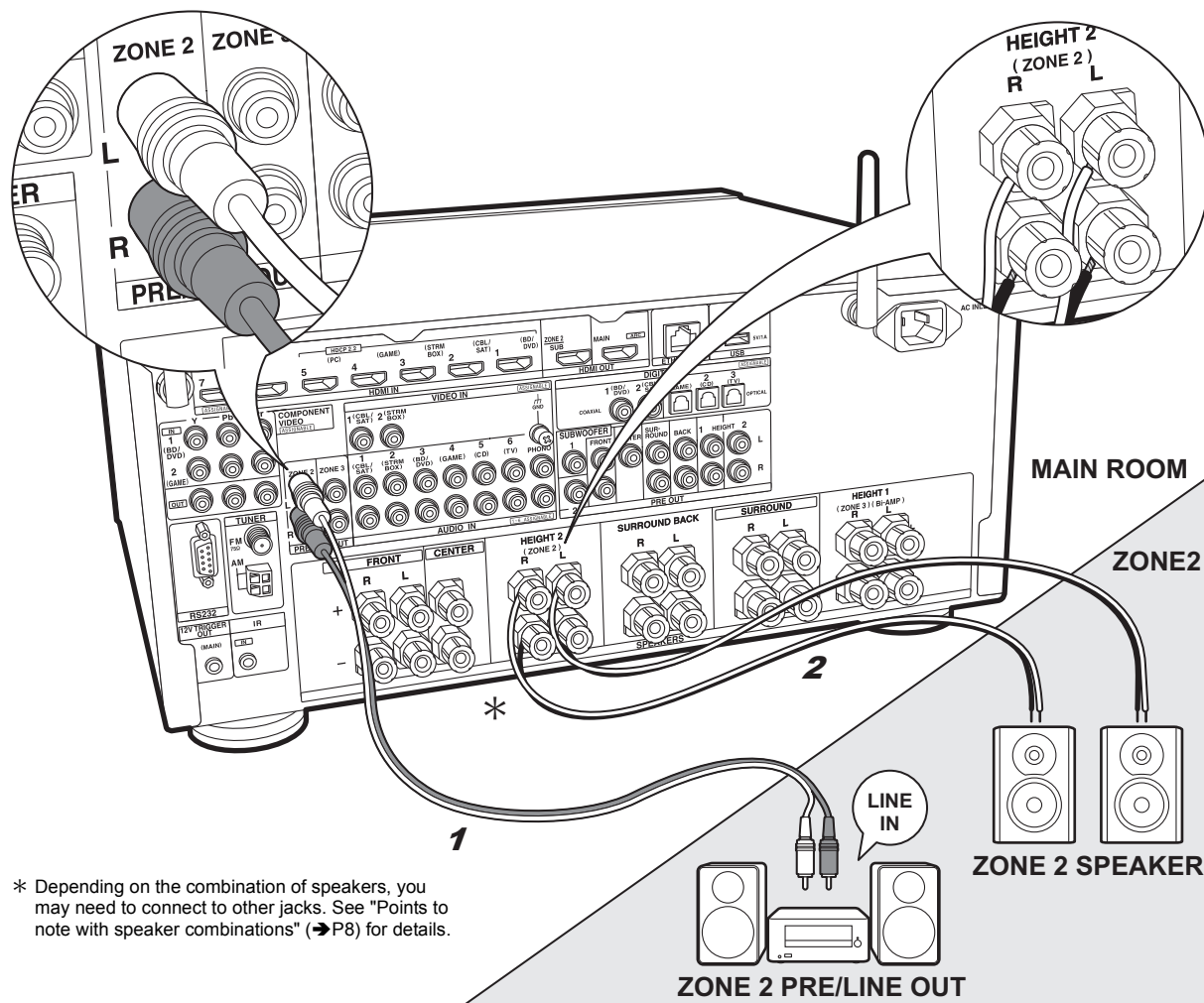

\* Depending on the combination of speakers, you may need to connect to other jacks. See "Points to note with speaker combinations" (→P8) for details.

1 Analog audio cable, 2 Speaker cable

## ✓ ZONE 2 PRE/LINE OUT / ZONE 2 SPEAKER

You can enjoy audio in the separate room by, for example, playing a Blu-ray Disc player in the main room (where this unit is located) and listening to internet radio in the separate room (ZONE 2).

### Connections with an AV component

Connect with HDMI IN 1 to 5 if you want to output an external AV component to ZONE 2. If the AV component doesn't have an HDMI jack, connect using a digital optical cable, digital coaxial cable, or analog audio cable.

### ZONE 2 PRE/LINE OUT

It is possible to play 2 ch sources in a separate room while sources with a maximum of 11.1 ch are being played in the main room. Connect the ZONE 2 PRE/LINE OUT jacks of the unit and the LINE IN jacks of the pre-main amplifier or the power amplifier in a separate room with an analog audio cable.

### ZONE 2 SPEAKER

It is possible to connect speakers in a separate room and play 2 ch sources.

- You can play through a maximum of 7.1 channels in the main room during ZONE 2 playback. With Bi-Amping connection or while ZONE 3 speaker connection settings are enabled, no sound is heard from the surround back speakers or height speakers and a maximum of 5.1 channel playback is possible in the main room. Listening modes such as Dolby Atmos cannot be selected.



### Setup

- Settings are required in Initial Setup, "4. Multi Zone Setup" (→P22) to enjoy this feature.
- The audio from externally connected AV components can only be played in ZONE 2 when the audio is analog or 2ch PCM audio. If you have connected to this unit with an HDMI cable or digital optical/coaxial cable, may be necessary to convert the audio output of the AV component to PCM output.

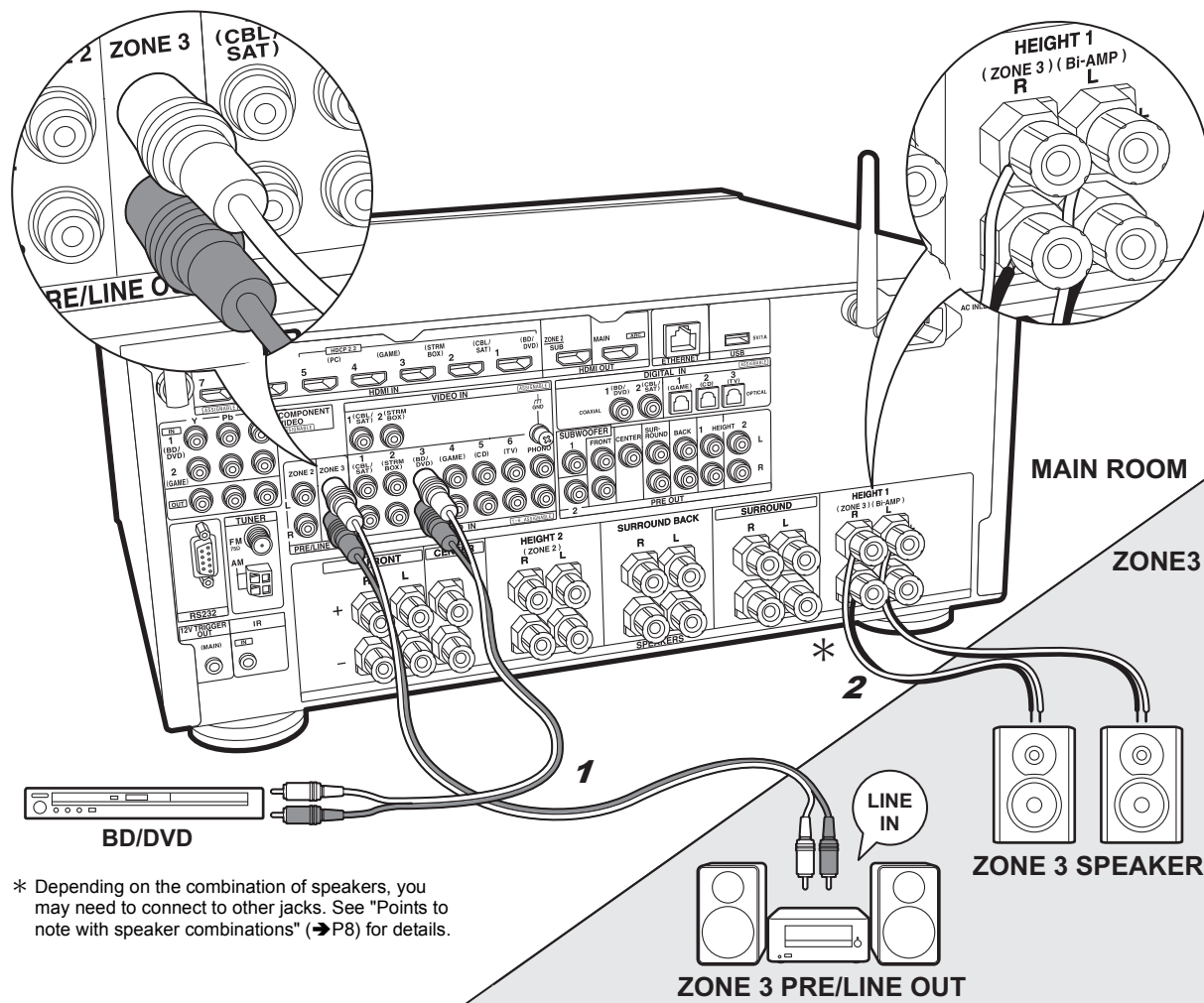

1 Analog audio cable, 2 Speaker cable

\* Depending on the combination of speakers, you may need to connect to other jacks. See "Points to note with speaker combinations" (→P8) for details.

## ✓ ZONE 3 PRE/LINE OUT / ZONE 3 SPEAKER

Along with the main room and ZONE 2, you can also enjoy audio in yet another room (ZONE 3).

### Connections with an AV component

To output the audio of an external AV component to ZONE 3, connect using an analog audio cable. Output to ZONE 3 is not possible when you connect with an HDMI cable or digital optical/coaxial cable.

### ZONE 3 PRE/LINE OUT

It is possible to play 2 ch sources in a separate room while sources with a maximum of 11.1 ch are being played in the main room. Connect the ZONE 3 PRE/LINE OUT jacks of the unit and the LINE IN jacks of the pre-main amplifier or the power amplifier in a separate room with an analog audio cable.

### ZONE 3 SPEAKER

It is possible to connect speakers in a separate room and play 2 ch sources.

- During ZONE 3 playback, no sound is heard from the surround back speakers or the height speakers and a maximum of 5.1 channel playback is possible in the main room. Listening modes such as the Dolby Atmos modes cannot be selected.

### Setup

- Settings are required in Initial Setup, "4. Multi Zone Setup" (→P22) to enjoy this feature.

## Step6: Connect Other Cables

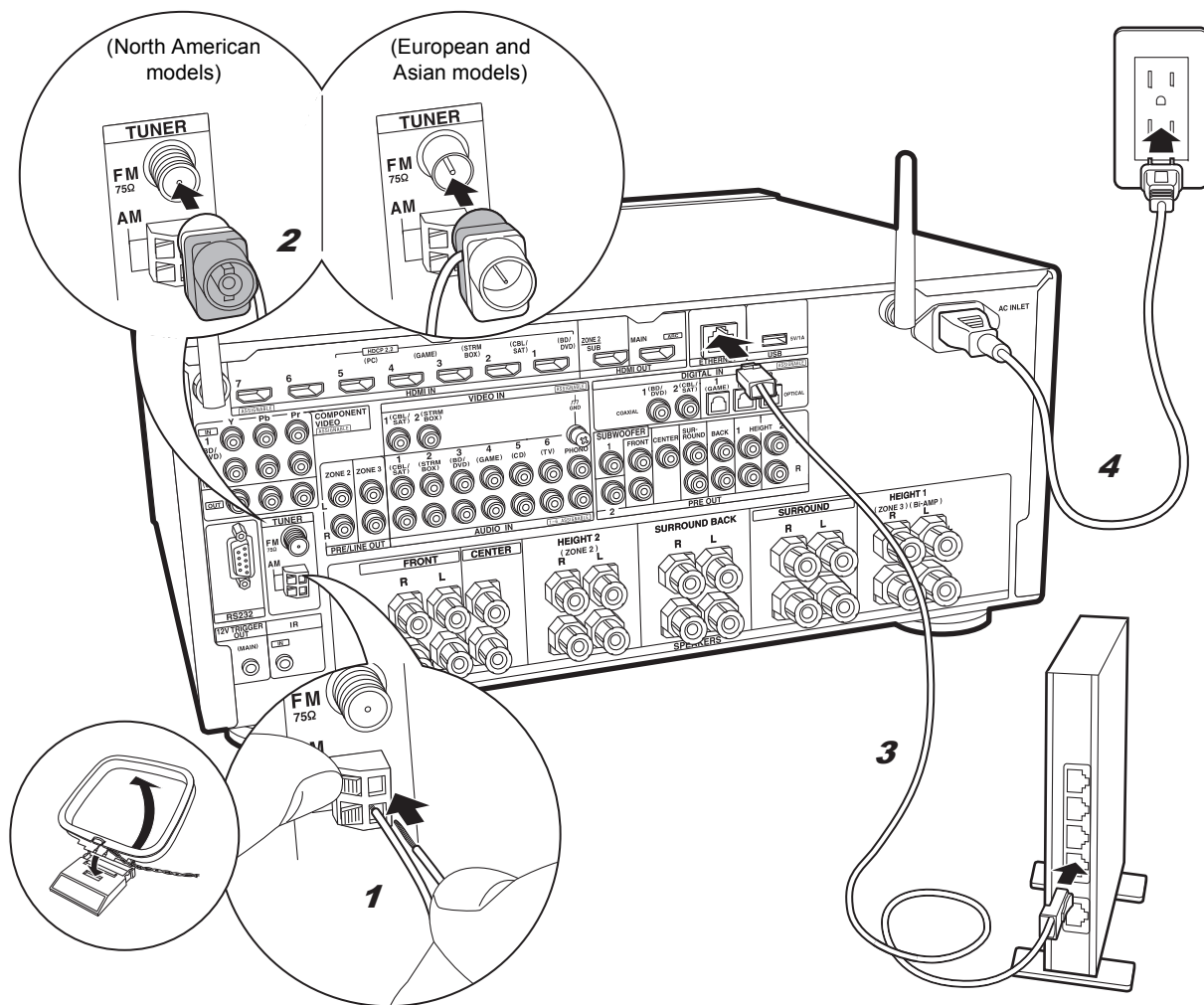

1 AM loop antenna, 2 Indoor FM antenna, 3 Ethernet cable, 4 Power cord

### Antenna Hookup

Move the antenna around while playing the radio to find the position with the best reception. Use a thumb tack or similar to attach the indoor FM antenna to a wall.

### Network Hookup

Connect this unit to the network using wired LAN or Wi-Fi (wireless LAN). You can enjoy network features such as internet radio, Music Server, and AirPlay by connecting the unit to the network.

If you connect by wired LAN, connect with an Ethernet cable to the ETHERNET port as shown in the illustration. To connect by Wi-Fi, then after selecting "Wireless" in "3. Network Connection" (➔P22) in Initial Setup, select the desired setting method and follow the onscreen instructions to configure the connection.

### Power Cord Hookup

This unit includes removable power cords. Connect the power cord to the power outlet after completing all other connections. Connect the power cord to AC INLET of the unit and then connect to the outlet. Always disconnect the outlet side first when disconnecting the power cord.

You can find the voltage selector switch on the rear panel of multi-voltage models. **Please set it to the correct voltage for your country or region.** Before changing the voltage, disconnect the power cord. Use a medium size screwdriver to change the voltage switch.

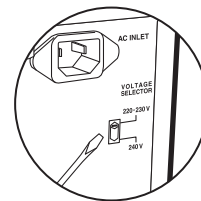

## Step7: Power On & Initial Setup

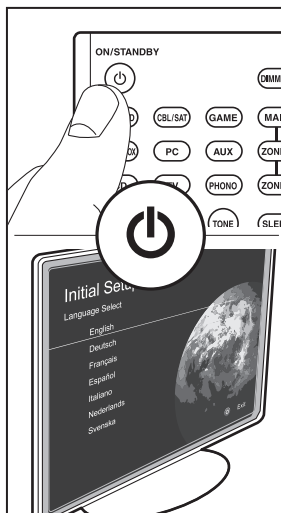
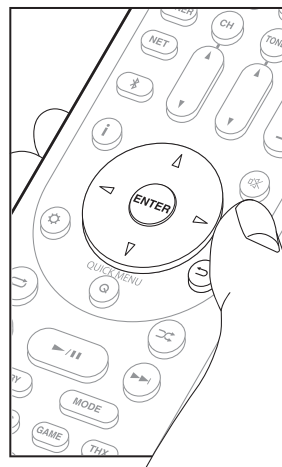
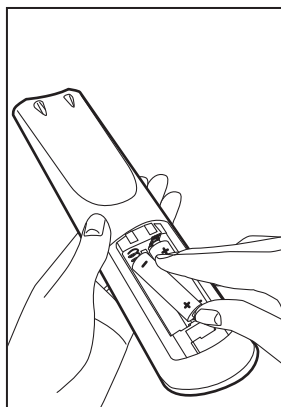
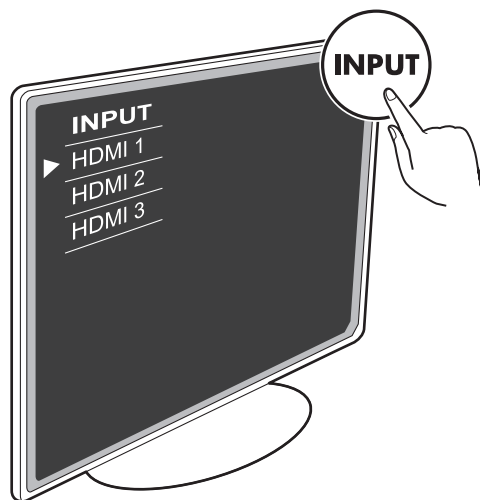

Δ ▽ ◀ ▶ : Selection

ENTER : OK

↶ ↷ : Return

### Initial Setup starts automatically

Switch the input on the TV to that assigned to the unit. When you turn the unit on for the first time, Initial Setup is automatically shown on the TV to enable you to make settings required for startup using simple operations following onscreen guidance.

- If you terminate the procedure on the way or want to change a setting made during Initial Setup, press on the remote controller, select "7. Miscellaneous" – "Initial Setup", and press ENTER.

### 1. AccuEQ Room Calibration

Place the supplied speaker setup microphone in the listening position, measure the test tones emitted by the speakers, then the unit automatically sets the optimum volume level for each speaker, the crossover frequencies, and the distance from the listening position. This also enables correction of distortion caused by the acoustic environment of the room.

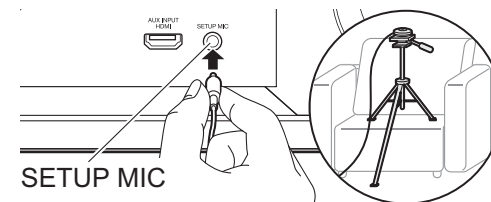

- When putting the speaker setup microphone on a tripod, refer to the illustration when putting it in place.
- Set the subwoofer volume to more than halfway.
- Calibration takes between 3 and 12 minutes to be completed. The speakers emit the test tone at high volume during measurement, so be careful of your surroundings. Keep the room as quiet as possible during measurement.
- When using THX certified speakers, THX recommends setting the crossover frequency to "80Hz(THX)". It is also recommended to manually adjust the settings for each speaker to suit the specific characteristics of each room.
- If the power of this unit suddenly turns off, the wires in the speaker cables may have touch the rear panel or other wires and tripped the protection circuit. Twist the wires again properly and make sure they do not stick out of the speaker terminals when connecting.



## 2. Source Connection

Check that each input source is connected correctly. Follow the guidance, select the input you want to confirm, start play of the selected player, and confirm that the images appear on the TV and that sound is played.

## 3. Network Connection

Set up Wi-Fi connection with an access point such as a wireless LAN router. There are the following two methods of connecting by Wi-Fi:

**"Scan Networks"**: Search for an access point from this unit. Find out the SSID of the access point beforehand.

**"Use iOS Device (iOS7 or later)"**: Share the iOS device's Wi-Fi settings with this unit.

If you select "Scan Networks", there are a further two choices of connection method. Check the following.

- **"Enter Password"**: Enter the password (or key) of the access point to connect.
- **"Push Button"**: If the access point has an automatic connection button, you can connect without entering a password.
- If the SSID of the access point is not displayed, then in the screen listing the SSIDs, select "Other..." with the ▷ cursor on the remote controller and press ENTER, then follow the onscreen instructions.

### Keyboard input



To switch between upper and lower case, select "A/a" on the screen and press ENTER. To select whether to mask the password with " \* " or display it in plain text, press MEMORY on the remote controller. Press CLR to delete all the input characters.

- A confirmation screen asking you to agree to the privacy policy is displayed during network setting. Select "Yes" and press ENTER to indicate agreement.

## 4. Multi Zone Setup

Make these settings to enjoy video and audio in a room other than the main room (ZONE 2/ZONE 3).

Select "Using AV Receiver" when connecting speakers in the separate room. Select "with External Pre-main Amplifier" when connecting a pre-main amplifier in the separate room. Select "with External Power Amplifier" when connecting a power amplifier.

If you are going to be connecting a TV in the separate room (ZONE 2), then when "Would you be using TV in 2nd room?" is displayed, select "Yes".

## 5. Audio Return Channel

If you have connected a TV that supports ARC, select "Yes". This unit's ARC setting turns on and you can listen to the TV's audio through this unit.

- If you select "Yes", the HDMI CEC function is enabled and power consumption increases during standby.

# HDMI Setup

## HDMI CEC

Make this setting to enable the control feature for devices complying with the CEC standard. This is set to on automatically if you have selected "Yes" in "5. Audio Return Channel" in the Initial Setup.

Press the ⚙ button on the remote controller to set "5. Hardware" – "HDMI" – "HDMI CEC" to "On" on the TV screen. Also enable the CEC control feature on the CEC device you have connected.

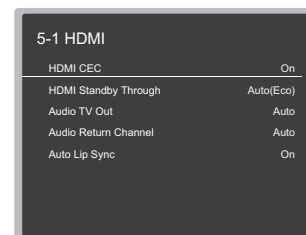

## HDMI Standby Through

Even if this unit is in standby, the input signals from AV components are transmitted to the TV.

- **"Auto" / "Auto (Eco)"**: Select one of these settings when connected AV components comply with the CEC standard. Irrespective of the input selector selected immediately before switching the unit to standby, you can transmit the input signals from AV components to the TV. Select "Auto (Eco)" if the TV is also CEC-compliant. You can reduce power consumption in standby mode.
  - **Input selector names for "BD/DVD", etc.:** You can transmit the input signals from the set input selector to the TV. It can be selected when "HDMI CEC" is set to "Off".
  - **"Last"**: You can transfer the input signals of the input selector selected immediately prior to the unit being switched to standby. It can be selected when "HDMI CEC" is set to "Off". With this setting, you can switch the input selector even in the standby mode.
- To exit the settings, press ⚙.

## Basic Playback

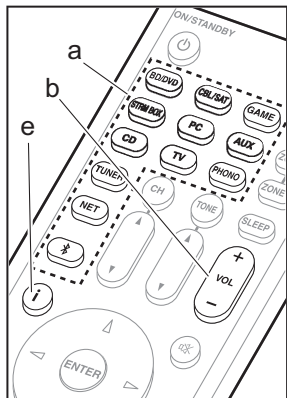

### AV Component Playback

1. Switch the input on the TV to that assigned to the unit.
2. Press the input selector (a) on the remote controller with the same name as the jack to which you connected the player to switch the input.  
For example, press BD/DVD to play the player connected to the BD/DVD jack. Press TV to listen the TV's sound.
  - When the CEC link function works, the input switches automatically when you have connected a CEC compliant TV and player to this unit using HDMI connection.
3. Start play on the player.
4. Use VOL+/- (b) to adjust the volume.

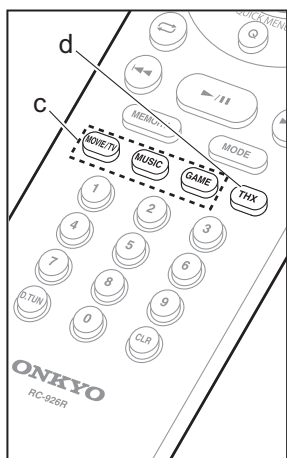

### When a TV is connected to the HDMI OUT SUB jack

Press Q on the remote controller to display the Quick Menu, and set "Other" – "HDMI Out" to either "SUB" or "MAIN+SUB".

### Listening Mode

This unit is equipped with a variety of listening modes, and you can select the optimum listening mode for movies, TV, music, and games by repeatedly pressing the MOVIE/TV, MUSIC, and GAME buttons (c). You can also select THX-related listening modes by repeatedly pressing THX (d). For details on the listening modes, see the Advanced Manual. This section introduces some of the popular modes.

#### Dolby Digital/DTS modes

When the input signal is a digital surround format such as Dolby Digital or DTS, you can

select the listening mode that suits the input signal. Dolby Digital is displayed for Dolby Digital and DTS-HD Master Audio is displayed for DTS-HD Master Audio. The output is Stereo for 2-channel input signals.

#### Direct

This listening mode can be selected for all input signals. It shuts down processing that affects sound quality to deliver a playback sound quality closer to sources. Speakers play the sound field according to the number of channels in the input signal, so there would be output from only the front speakers for a 2 ch signal, for example.

#### Dolby Surround/DTS Neural:X

These listening modes allow you to expand the playback signal to a maximum of 11 channel to suit the connected speaker configuration when the input signal is 2 channels or 5.1 channels.

#### THX surround modes

Multiple surround speakers are installed in movie theaters so that the moviegoer is enveloped in a natural surround sound. Even with just two surround speakers, the THX Cinema mode achieves, with the high-quality technology developed by THX, the same kind of breadth of sound you would get in a movie theater along with the natural flow of timbre with the sound field towards the front. Also available are modes such as THX Music and THX Games.

#### Original surround modes

You can select listening modes such as the All Ch Stereo mode where a stereo image is played from both the front and the rear, and Orchestra (only with the MUSIC button) which is best for playback of classical and opera pieces.

#### Pure Audio

Listening mode that provides purer sound quality by switching off the power of the display and analog video circuits.

The listening mode last selected for the source is remembered for each of the MOVIE/TV, MUSIC, GAME and THX buttons. If content you play is not supported by the listening mode you selected last, the listening mode that is standard for that content is selected automatically. Press **↓** (e) repeatedly to switch the display of the main unit in order of:

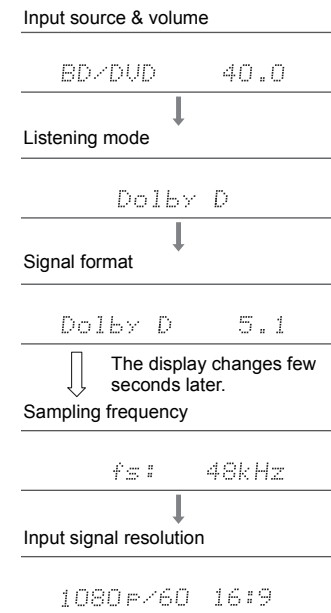

## Network Functions

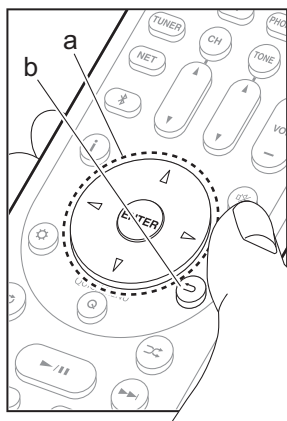
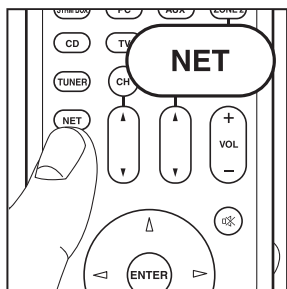

### Network Services

1. Switch the input on the TV to that assigned to the unit.
2. Press NET to display the network service list screen.

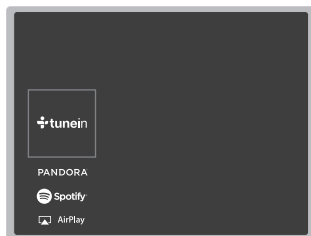

3. Select the item with the cursors of the remote controller and press ENTER to confirm your selection (a). To return to the previous screen, press ↵ (b).

### Internet Radio

When this unit is connected to a network, you can listen to TuneIn or other preregistered Internet radio services. After selecting the desired service, follow the on-screen instructions, using the cursors to select radio stations and programs, then press ENTER to play. Play starts when 100% is displayed for buffering.

### Music Server

You can play music files stored on home-network compliant PCs or NAS devices connected to the same network as this unit. Select the server with the cursors, select the desired music file and press ENTER to start playback. Play starts when 100% is displayed for buffering.

- This unit is compatible with Windows Media®

Player 11 or 12 network servers or NAS that are compatible with home network functionality. You may need to make some settings in advance to use Windows Media® Player 11 or 12. Enable media streaming for this player in Windows Media® Player. For details, see the Advanced Manual.

### USB

Play music files on a USB storage device. Connect the USB storage device to the USB jack on the rear of the unit, select the desired folder or music file with the cursors, and press ENTER to confirm and start playback.

- Operation cannot be guaranteed for all USB storage devices.
- This unit can use USB storage devices that comply with the USB mass storage device class standard. The unit is also compatible with USB storage devices using the FAT16 or FAT32 file system formats.



### Notes:



- Network services become selectable after the network starts up even if they cannot be selected first.
- Functionality may be introduced by firmware updates and service providers may cease services, meaning that some network services and content may become unavailable in the future. Furthermore, available services may vary depending on your area of residence.

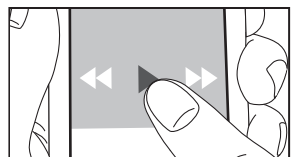
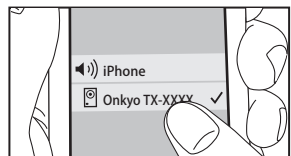
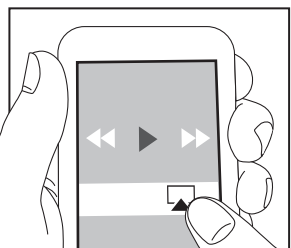
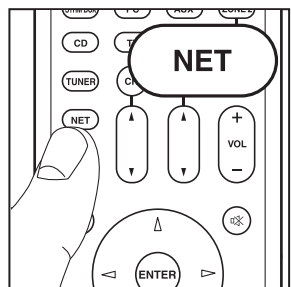



## AirPlay

You can wirelessly enjoy the music files on an iPhone®, iPod touch®, or iPad® connected to the same access point as this unit.

- Update the OS version on your iOS device to the latest version.
1. Connect the iOS device to the access point.
  2. Press NET.
  3. Tap the AirPlay icon  in the control center of the iOS device and select this unit from the list of devices displayed, and tap "Done".
  4. Play the music files on the iOS device.
    - The default status is for the Network Standby feature to be on, so when you do steps 3 and 4 above, this unit automatically comes on and input switches to "NET". To reduce the amount of power consumed in standby mode, press the  button on the remote controller, then in the Setup menu displayed set "5. Hardware" – "Power Management" – "Network Standby" to "Off".
    - Due to the characteristics of AirPlay wireless technology, the sound produced on this unit may slightly be behind the sound played on the AirPlay-enabled device.

You can also play back music files on the computer with iTunes (Ver. 10.2 or later). Before operation, make sure this unit and the PC are connected to the same network, then press NET on this unit. Next, click the AirPlay icon  in iTunes, select this unit from the list of devices displayed, and start play of a music file.

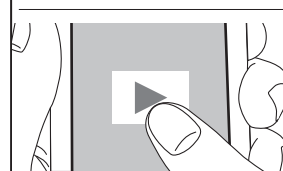
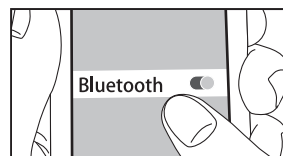
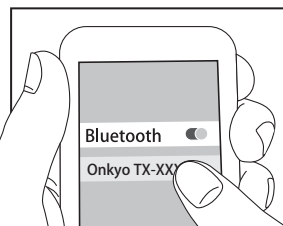
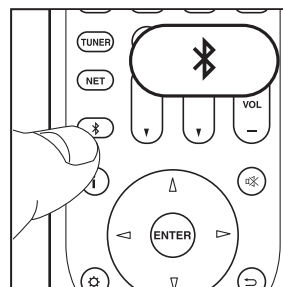

## BLUETOOTH® Playback

### Pairing

1. When you press the  button on the remote controller, "Now Pairing..." is displayed on this unit's display, and the pairing mode is enabled.

Now Pairing...

2. Enable (turn on) the BLUETOOTH function of the BLUETOOTH enabled device, then select this unit from amongst the devices displayed.
  - If a password is requested, enter "0000".
  - To connect another BLUETOOTH enabled device, press and hold the  button until "Now Pairing..." is displayed, then perform step 2 above. This unit can store the data of up to 8 paired devices.
  - The coverage area is 48 feet (15 meters). Note that connection is not always guaranteed with all BLUETOOTH enabled devices.

### Playing Back

1. When the unit is on, connect the BLUETOOTH enabled device.
2. The input selector of this unit will be automatically switched to "BLUETOOTH".
3. Play music. Increase the volume of the BLUETOOTH enabled device to an appropriate level.
  - Due to the characteristics of BLUETOOTH wireless technology, the sound produced on this unit may slightly be behind the sound played on the BLUETOOTH enabled device.

## Others

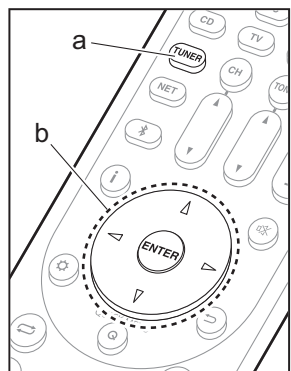

### Listening To the Radio

1. Press TUNER (a) on the remote controller repeatedly to select either "AM" or "FM" on the display.
2. Press MODE (c) on the remote controller, so that the "TunMode: Auto" is displayed on the display.
3. When you press the  $\Delta$  /  $\nabla$  cursor (b) buttons on the remote controller, automatic tuning starts, and searching stops when a station is found. When tuned into a radio station, the "TUNED" indicator on the display lights.

You can preset up to 40 stations.

1. Tune into the AM/FM radio station you want to register.
2. Press MEMORY (d) on the remote controller so that the preset number on the display flashes.
3. While the preset number is flashing (about 8 seconds), repeatedly press the  $\triangleleft$  /  $\triangleright$  cursor (b) buttons on the remote controller to select a number between 1 and 40.
4. Press MEMORY (d) again on the remote controller to register the station. When registered, the preset number stops flashing. To select a preset radio station, press the  $\triangleleft$  /  $\triangleright$  cursor (b) buttons on the remote controller.
  - To delete a preset station, press the  $\triangleleft$  /  $\triangleright$  cursor (b) buttons on the remote controller to select the preset number you want to delete, press MEMORY (d) on the remote controller and then press CLR (e) while the preset number is flashing. When deleted, the number on the display goes off.

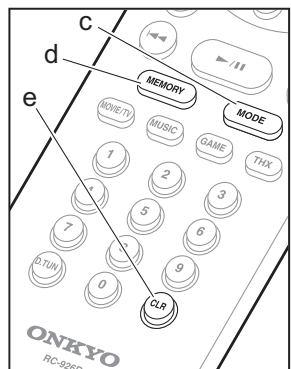

### Frequency step setting

Press the  $\odot$  button on the remote controller to select "7. Miscellaneous" – "Tuner" – "AM/FM Frequency Step" or "AM Frequency Step" and select the frequency step for your area. Note that when this setting is changed, all radio presets are deleted.

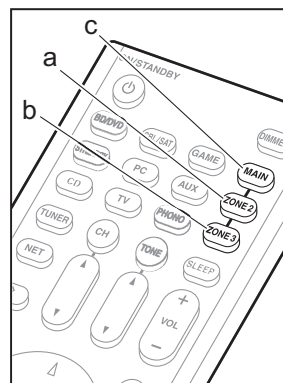

### Multi-zone

#### Play

1. Switch the remote controller to the mode for controlling ZONE 2 or ZONE 3.
  - To switch to the mode for controlling ZONE 2, press ZONE 2 (a) on the remote controller.
  - To switch to the mode for controlling ZONE 3, press ZONE 3 (b) on the remote controller.

**i** To return the remote controller to main room control mode: Press MAIN (c) on the remote controller.

2. Point the remote controller at the main unit and press  $\odot$  ON/STANDBY (d). "Z2" or "Z3" lights on the main unit display.



3. Press the input selector button (e) of the input to be played in the separate room. On the main unit, after pressing ZONE 2 or ZONE 3, within 8 seconds press the input selector button to select the input to be played in the separate room. To play the same source in the main room and separate room, press ZONE 2 or ZONE 3 on the main unit twice.
  - You cannot select different inputs for the main room and separate room with the "NET" or "BLUETOOTH" input selector. You cannot select different stations for the main room and separate room with the AM/FM radio. When you select an input or station for the separate room, the main room also switches.
  - DSD and Dolby TrueHD audio signals are not output to ZONE 2/ZONE 3 when selected with the "NET" input selector.
  - If ZONE 2 or ZONE 3 is turned on when the listening mode of the main room is Pure Audio, it will automatically switch to the Direct listening mode.
4. To adjust the volume on the power amplifier in the

separate room or the ZONE Speaker, adjust with VOL+/- on the remote controller. To control on the main unit, press ZONE 2 or ZONE 3 and adjust with the MASTER VOLUME control within 8 seconds.

- The information for a connected device can be displayed on the TV screen in a separate room. Press the  button while the remote controller is in the mode for controlling ZONE 2.
- Power consumption in standby mode increases when the multi-zone function is being used.

#### To turn off the function

Press  ON/STANDBY while in the mode for controlling ZONE 2 or ZONE 3 on the remote controller.

#### Playing in ZONE 2 or ZONE 3 only

If you turn the unit to standby during multi-zone playback, the Z2 or Z3 indicator is dimmed and the playback mode is switched to playback in a separate room only. Setting ZONE 2/ZONE 3 to on while this unit is in standby will also switch the playback mode to the same setting.

#### WHOLE HOUSE MODE

If you press WHOLE HOUSE MODE while playback is being performed in the main room, the WHOLE HOUSE MODE is turned on, "Z2" and "Z3" on the display light at the same time and the playback sources of all the rooms are switched to the same source at once.

- The sources that can be played in ZONE 2 can be played in all rooms.
- This function cannot be used if headphones are connected or audio is output from the speakers of the TV.

#### Settings

Settings are required in Initial Setup, "4. Multi Zone Setup" (➔P22) to use the multi-zone feature. When checking the setting content, refer to the following, press  on the remote controller, and check in the Setup menu that is displayed.

- When you have connected a TV in the separate room with an HDMI cable, have you selected "Use" in "1. Input/

- Output Assign" – "TV Out/OSD" – "Zone2 HDMI"?
- When you are playing the audio from an AV component with an HDMI cable in the separate room, have you selected "Use" in "1. Input/Output Assign" – "TV Out/OSD" – "Zone2 HDMI"?
- When you have connected speakers in a separate room with speaker cable, have you selected "Zone 2" or "Zone 2/Zone 3" in "2. Speaker" – "Configuration" – "Zone Speaker"?
- When you have connected a power amplifier in a separate room with an analog audio cable and you want to control the volume with this unit, have you selected "Variable" in "6. Multi Zone" – "Zone 2" or "Zone 3" – "Output Level"?

#### Others

##### To adjust the sound quality

It is possible to enhance or moderate the bass and treble range of all channels except the subwoofer channel. Press TONE on the main unit several times to select the desired setting from "Bass" and "Treble", and turn the TONE dial to adjust.

- This cannot be set if the listening mode is Pure Audio, Direct or THX.
- You can also adjust the sound quality of a power amplifier connected in a separate room. After pressing either ZONE 2 or ZONE 3 on the main unit, within 8 seconds press TONE and turn the TONE dial to adjust.

##### Quick Menu

By pressing Q on the remote controller during play, you can adjust frequently used settings, such as the sound quality, using on-screen menus. Select the item with the cursors of the remote controller and press ENTER to confirm your selection. To return to the previous screen, press .

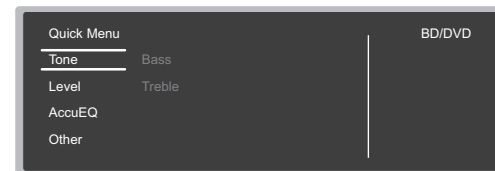

- You can adjust the sound quality with "Tone". "Other" includes settings such as "A/V Sync" that allows you to adjust the audio delay when the video is behind the audio, "Music Optimizer" that provides better sound quality for compressed audio, and "HDMI Out" which allows you to select the HDMI OUT terminal to output from "MAIN", "SUB", and "MAIN+SUB".

## When the unit is operating erratically

---

### Try restarting the unit

Restarting the unit may help it operate more smoothly. To restart the unit, turn it to standby, and then press **⏻ ON/STANDBY** on the main unit for at least 5 seconds. (The unit's settings will be maintained.) If there is no improvement even after the unit is restarted, try disconnecting and reconnecting the power cords of the unit and connected equipment.

### Resetting the unit (this resets the unit settings to the default)

If restarting the unit doesn't fix the problem, resetting the unit to the status at the time of shipment may solve the problem. If you reset the unit status, your preferences will be reset to the defaults. Note them down before the operation below.

1. While pressing the CBL input selector button on the main unit, press **⏻ ON/STANDBY**.
2. "Clear" appears on the display and the unit returns to standby. Do not unplug the power cord until "Clear" disappears from the display.

To reset the remote controller, while holding down CLR, press MODE until MAIN flash twice (about 3 seconds).

## When the subwoofer produces no sound

---

If the setting of the front speakers is "Full Band" and during 2ch input such as from the TV or music, the low range elements will be output from the front speakers rather than from the subwoofer. If you would rather output from the subwoofer, make one of the following settings.

1. Change the front speakers settings to a setting other than "Full Band" for the crossover frequency value. The range below the frequency you specify will be output from the subwoofer rather than the front speakers. We do not recommend changing this if your front speakers have good low range reproduction capabilities.
2. Change "Double Bass" to "On". The low range elements will be output from both the front speakers and the subwoofer. This may mean that there is too much bass. Do not change if this happens, or choose option 1.

Refer to "Setup Menu" — "Crossover" in the Advanced Manual for details.

## Front Panel

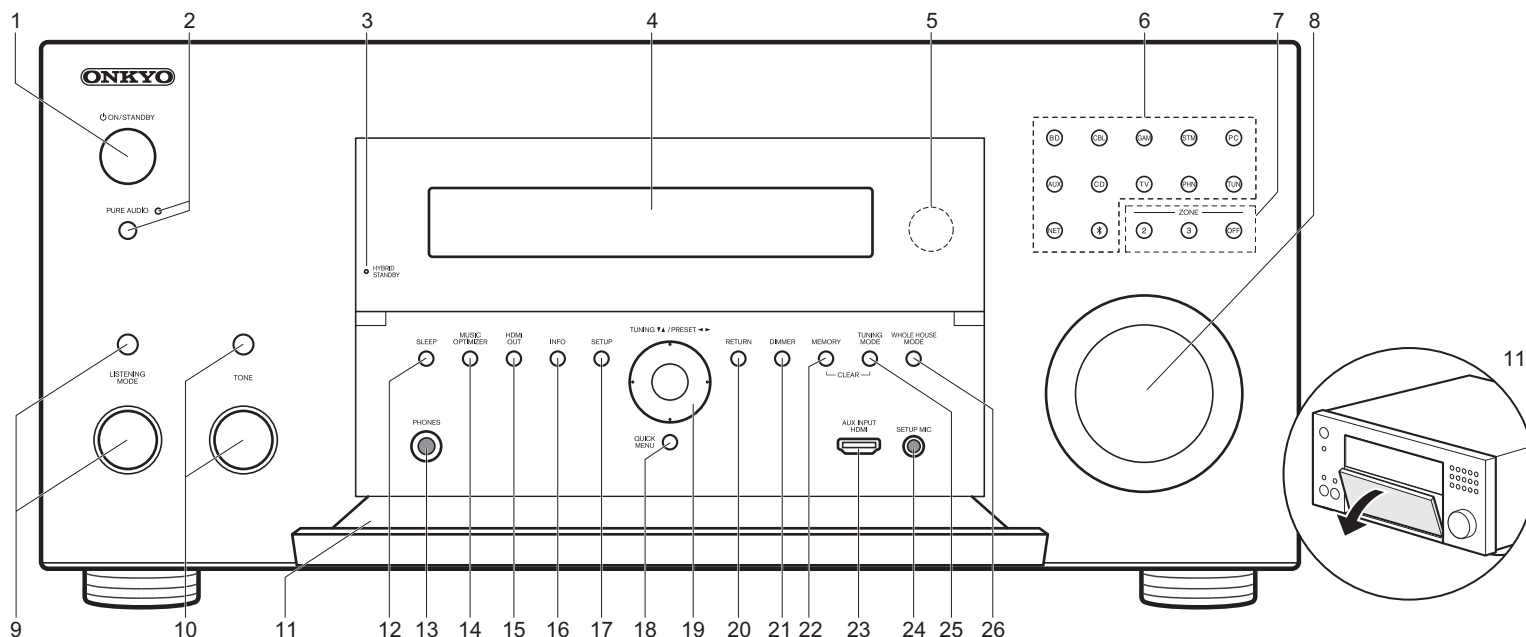

1. **⏻ ON/STANDBY button:** Turns the unit on or into standby mode.
2. **PURE AUDIO button/indicator:** Switches the unit to Pure Audio mode. (→P23)
3. **HYBRID STANDBY indicator:** Lights if the unit enters standby mode when the features are enabled that continue to work when this unit is in standby, such as HDMI Standby Through and Network Standby.
4. **Display (→P30)**
5. **Remote control sensor**
6. **Input selector buttons:** Press the following buttons to switch the input to be played. The jack allocated to the buttons at the time of purchase are shown inside the parentheses ( ).  
BD (BD/DVD)  
CBL (CBL/SAT)  
GAM (GAME)  
STM (STRM BOX)  
PC (PC)  
AUX (AUX INPUT HDMI)  
CD (CD)  
TV (TV)  
PHN (PHONO)  
TUN: AM/FM Radio  
NET: Playing the Internet Radio, USB, etc.  
⌘ : BLUETOOTH function
7. **ZONE 2/ZONE 3 buttons:** Controls the multi-zone function. (→P26)  
OFF button: Switches the multi-zone function off.
8. **MASTER VOLUME:** Allows you to adjust the volume.
9. **(Up) LISTENING MODE button / (Down) LISTENING MODE dial:** Allows you to select the listening mode. Press the button repeatedly to select a category from "Movie/TV", "Music", "Game", then turn the dial to change the mode. (→P23)
10. **(Up) TONE button / (Down) TONE dial:** Adjusts the high tone and low tone. Press the button repeatedly to select the item to adjust from "Bass" and "Treble", and turn the dial to adjust.
11. **Front flap**
12. **SLEEP button:** Set the sleep timer. Select from "30 minutes", "60 minutes", and "90 minutes".
13. **PHONES jack:** Stereo headphones with a standard plug (1/4 inch or ø6.3 mm) are connected.
14. **MUSIC OPTIMIZER button:** Turns on/off the Music

## Display

Optimizer function that provides better sound quality for compressed audio.

15. **HDMI OUT** button: Allows you to select the HDMI OUT jack to output video signals from "MAIN", "SUB", and "MAIN+SUB".
16. **INFO** button: Switches the information on the display.
17. **SETUP** button: Displays the Setup menu.
18. **QUICK MENU** button: You can perform common settings on the TV screen. (→P27)
19. **Cursor buttons** (TUNING ▼ ▲ / PRESET ◀ ▶ button) and **ENTER** button: Select the item with the cursors and press ENTER to confirm your selection. When using the TUNER, select the frequency with TUNING ▼ ▲, or select preset stations with PRESET ◀ ▶.
20. **RETURN** button: Returns the display to the previous state.
21. **DIMMER** button: You can adjust the brightness of the display in three steps. It cannot be turned off completely.
22. **MEMORY** button: Used to register AM/FM radio stations.
23. **AUX INPUT HDMI** jack: Connect to a video camera, etc., using a HDMI cable.
24. **SETUP MIC** jack: The supplied speaker setup microphone is connected.
25. **TUNING MODE** button: Switches the tuning mode.
26. **WHOLE HOUSE MODE** button: Enables the WHOLE HOUSE MODE function to play the same source in all the multi-zone connected rooms. (→P27)

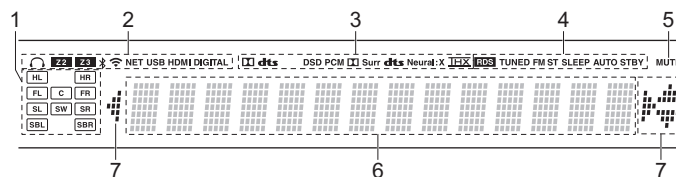

1. **Speaker/Channel display**: Displays the output channel that corresponds to the selected listening mode.
2. **Lights in the following conditions.**
  - 🎧: When headphones are connected.
  - Z2/Z3: When ZONE 2/ZONE 3 is on.
  - 📶: When connected by BLUETOOTH.
  - 📶: When connected by Wi-Fi.
  - NET: When "NET" is selected with the input selector and the unit is connected to the network. It will flash if the connection to the network is not correct.
  - USB: When "NET" is selected with the input selector and the unit is connected by USB and the USB device is selected. Flashes if the USB is not properly connected.
  - HDMI: When HDMI signals are input and the HDMI input is selected.
  - DIGITAL: When digital signals are input and the digital input is selected.
3. **Lights according to the type of input digital audio signals and the listening mode.**
4. **Lights in the following conditions.**
  - RDS (European and Asian models): Receiving RDS broadcasting.
  - TUNED: Receiving AM/FM radio.
  - FM ST: Receiving FM stereo.
  - SLEEP: When the sleep timer is set.
  - AUTO STBY: When Auto Standby function is enabled.
5. **Flashes when muting is on.**
6. **Displays various information of the input signals.** Characters that cannot be displayed on this unit are replaced with asterisks ( \* ).
  - When playing back software which has been encoded in Dolby Digital, Dolby Digital Plus, Dolby TrueHD and Dolby Atmos, sometimes you may see a brief message which will read "DialogNorm: X dB" (X being a numeric value). For example, if you see the following message: "DialogNorm:+4dB", to keep the overall output level at THX calibrated loudness, just turn down the volume control by 4dB.
7. **Lights when operating the "NET" input selector** indicating remote controller cursor operations are possible in screens showing list of tracks, for example.

## Rear Panel

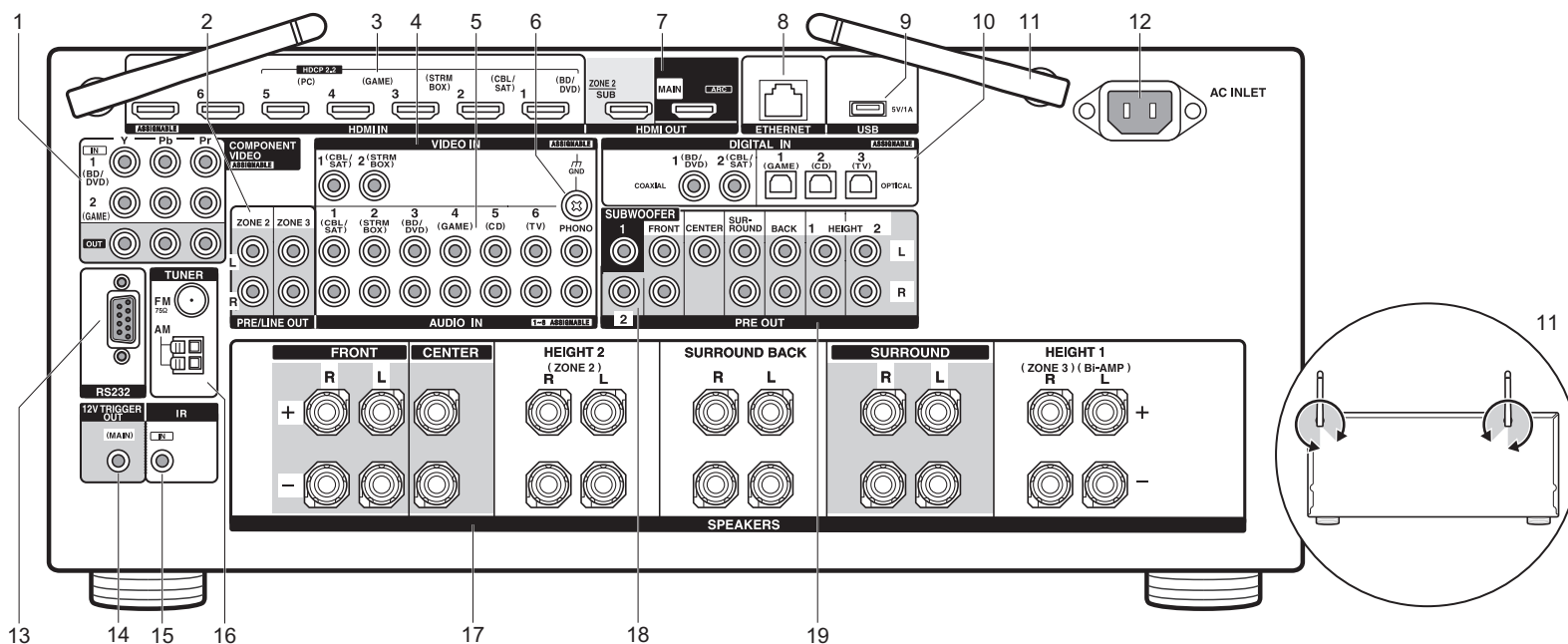

1. COMPONENT VIDEO IN/OUT jacks: Transfer the video signals of an AV component with a component video cable.
2. ZONE 2/ZONE 3 PRE/LINE OUT jacks: Output audio signals with an analog audio cable to a pre-main amplifier or a power amplifier in a separate room (ZONE 2/ZONE 3). (→P18, 19)
3. HDMI IN jacks: Transmit video signals and audio signals with a HDMI cable connected to an AV component.
4. VIDEO IN jacks: Input the video signals from AV components with an analog video cable.
5. AUDIO IN jacks: Input TV or AV component audio signals with an analog audio cable.
6. GND terminal: The ground wire of the turntable is connected.
7. HDMI OUT jacks: Transmit video signals and audio signals with a HDMI cable connected to a monitor such

- as a TV or projector.
8. ETHERNET port: Connect to the network with an Ethernet cable.
9. USB port: A USB storage device is connected so that music files stored in it can be played. You can also supply power (maximum 5V/1A) to USB devices with a USB cable.
10. DIGITAL IN OPTICAL/COAXIAL jacks: Input the digital audio signals from TV or AV components with a digital optical cable or digital coaxial cable.
11. Wireless antenna: Used upright for Wi-Fi connection or when using a BLUETOOTH enabled device. The diagram shows the movable range for the wireless antenna. Do not try to force it beyond this range otherwise you may break it.
- 12.AC INLET: The supplied power cord is connected.

- 13.RS232 port: For connection to the home control system.
- 14.12V TRIGGER OUT jacks: Allows you to connect a device with 12V trigger input jack to enable link operation between the device and the unit.
- 15.IR IN port: Allows you to connect a multiroom remote control kit.
- 16.TUNER AM/FM 75Ω terminal: The supplied antennas are connected.
- 17.SPEAKERS terminals: Connect speakers with speaker cables. (North American models are compatible with banana plugs.)
- 18.SUBWOOFER PRE OUT jacks: Connect a powered subwoofer with a subwoofer cable. Up to two powered subwoofers can be connected. You can set the volume levels of the 2 powered subwoofers to different levels.
- 19.PRE OUT jacks: Connect a power amplifier.

## Remote Controller

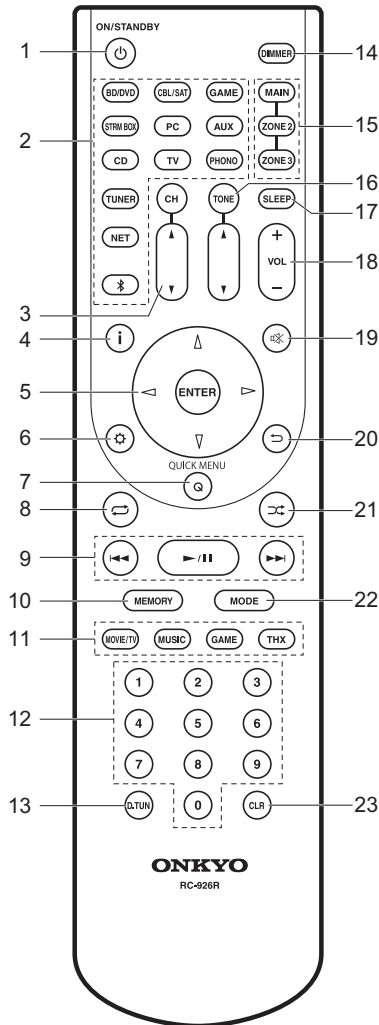

1. **ON/STANDBY** button: Turns the unit on or into standby mode.
2. **Input selector** buttons: Switches the input to be played.
3. **CH ▲ / ▼** buttons: Adjust the volume level of the speaker. Press CH several times to select the speakers, then press ▲ / ▼ to adjust the level.
4. **i** button: Switches the information on the display.
5. **Cursor** buttons and **ENTER** button: Select the item with the cursors and press ENTER to confirm your selection.
6. **Setup** button: Displays the Setup menu.
7. **Q (QUICK MENU)** button: You can perform common settings on the TV screen. (→P27)
8. **Repeat play** button: You can start repeat play of the Music Server or USB.
9. **Play** buttons: You can start play of the Music Server or USB.
10. **MEMORY** button: Used to register AM/FM radio stations.
11. **LISTENING MODE** buttons: Allows you to select the listening mode. (→P23)
12. **Numbered** buttons
13. **D.TUN** button: Use to directly input the frequency of AM/FM stations when tuning.
14. **DIMMER** button: You can adjust the brightness of the display in three steps. It cannot be turned off completely.
15. **MAIN/ZONE 2/ZONE 3** buttons: Controls the multi-zone function. (→P26)
16. **TONE ▲ / ▼** buttons: Adjusts the treble and bass. Press TONE several times to select the item you want to adjust from "Bass" and "Treble", then press ▲ / ▼ to adjust the level.
17. **SLEEP** button: Set the sleep timer. Select from "30 minutes", "60 minutes", and "90 minutes".
18. **Volume** buttons: Allows you to adjust the volume. This button also cancels the muting.
19. **MUTE** button: Temporarily mutes audio. Press again to cancel muting.
20. **Previous** button: Returns the display to the previous state.
21. **Random play** button: You can start random play of the Music Server or USB.
22. **MODE** button: Switches tuning to an AM/FM station between automatic tuning and manual tuning.
23. **CLR** button: Deletes all characters you have entered when entering text on the TV screen.

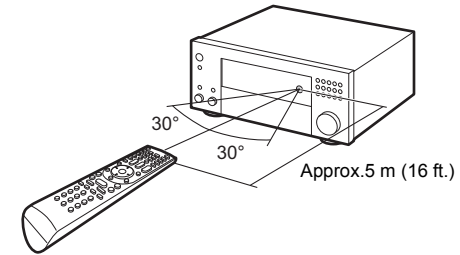



## License and Trademark Information

### DOLBY ATMOS

Manufactured under license from Dolby Laboratories. Dolby, Dolby Atmos, Dolby Surround, and the double-D symbol are trademarks of Dolby Laboratories.



For DTS patents, see <http://patents.dts.com>. Manufactured under license from DTS, Inc. DTS, the Symbol, DTS in combination with the Symbol, DTS:X, and the DTS:X logo are registered trademarks or trademarks of DTS, Inc. in the United States and/or other countries. © DTS, Inc. All Rights Reserved.



THX and the THX logo are trademarks of THX Ltd., registered in the U.S. and other countries. U.S. Pat. nos. 7,254,239 & 7,593,533 & 7,974,425 & 8,452,028 & 8,509,457 Taiwan Pat. I238671 European Pat. 1,360,874

#### THX Select2 Plus

Before any home theater component can be THX Select2 Plus certified, it must pass a rigorous series of quality and performance tests. Only then can a product feature the THX Select2 Plus logo, which is your guarantee that the Home Theater products you purchase will give you superb performance for many years to come. THX Select2 Plus requirements define hundreds of parameters, including power amplifier performance, and integrated amplifier performance and operation for both digital and analog domains. THX Select2 Plus receivers also feature proprietary THX technologies (e.g., THX Mode) which accurately translate movie soundtracks for home theater playback.

Re-Equalization and the "Re-EQ" logo are trademarks of THX Ltd.



"VLSC" and "VLSC (logo)" are trademarks of Onkyo Corporation.



The terms HDMI and HDMI High-Definition Multimedia Interface, and the HDMI Logo are trademarks or registered trademarks of HDMI Licensing LLC in the United States and other countries.



The Wi-Fi CERTIFIED Logo is a certification mark of Wi-Fi Alliance®.



AirPlay, iPad, iPhone, and iPod touch are trademarks of Apple Inc., registered in the U.S. and other countries.

iPad Air and iPad mini are trademarks of Apple Inc.

"Made for iPod", "Made for iPhone" and "Made for iPad" mean that an electronic accessory has been designed to connect specifically to iPod, iPhone, or iPad, respectively, and has been certified by the developer to meet Apple performance standards. Apple is not responsible for the operation of this device or its compliance with safety and regulatory standards.

Please note that the use of this accessory with iPod, iPhone or iPad may affect wireless performance.

AirPlay works with iPhone, iPad, and iPod touch with iOS 4.3.3 or later, Mac with OS X Mountain Lion or later, and PC with iTunes 10.2.2 or later.

Apple, Apple TV and Safari are trademarks of Apple Inc., registered in the U.S. and other countries.



The BLUETOOTH® word mark and logos are registered trademarks owned by Bluetooth SIG, Inc. and any use of such marks by Onkyo Corporation is under license. Other trademarks and trade names are those of their respective owners.

Onkyo Corporation does not guarantee BLUETOOTH compatibility between the AV receiver and all BLUETOOTH enabled devices. For compatibility between the AV receiver and another device with BLUETOOTH technology, consult the device's documentation and dealer. In some countries, there may be restrictions on using BLUETOOTH devices. Check with your local authorities.

Onkyo Corporation ne garantit pas la compatibilité BLUETOOTH entre l'amplificateur AV et tous les appareils compatibles BLUETOOTH. Pour assurer la compatibilité entre l'amplificateur AV et un autre périphérique à technologie BLUETOOTH, consultez la documentation de l'appareil et le vendeur. Dans certains pays, il peut exister des restrictions sur l'utilisation d'appareils BLUETOOTH. Vérifiez auprès des autorités locales.

Onkyo Corporation no garantiza la compatibilidad BLUETOOTH entre el receptor de AV y todos los dispositivos con tecnología BLUETOOTH. Para obtener información sobre la compatibilidad entre el receptor de AV y otro dispositivo con tecnología BLUETOOTH, consulte al distribuidor y la documentación del dispositivo. En algunos países, es posible que el uso de dispositivos BLUETOOTH esté restringido. Consulte con las autoridades locales.

Onkyo Corporation non garantisce la compatibilità BLUETOOTH tra il ricevitore AV e tutti i dispositivi abilitati al BLUETOOTH. Per verificare la compatibilità tra il ricevitore AV e un altro dispositivo dotato di tecnologia BLUETOOTH, consultare la documentazione del dispositivo in questione o contattare il rivenditore. In alcuni Paesi potrebbero esistere delle limitazioni per l'utilizzo di dispositivi BLUETOOTH. Verificare le condizioni con le autorità locali.

Onkyo Corporation garantiert nicht die BLUETOOTH Kompatibilität zwischen dem AV-Receiver und allen BLUETOOTH fähigen Geräten. Zur Kompatibilität zwischen dem AV-Receiver und einem anderen Gerät mit BLUETOOTH Technologie, schauen Sie in die Dokumentation des Geräts und fragen Sie den Händler. Es kann sein, dass es in einigen Ländern Beschränkungen zur Nutzung der BLUETOOTH Geräte gibt. Prüfen Sie das bei



Ihren lokalen Behörden.

Onkyo Corporation garandeert niet de BLUETOOTH compatibiliteit tussen de AV-receiver en alle BLUETOOTH apparaten. Raadpleeg voor compatibiliteit tussen de AV-receiver een ander apparaat met BLUETOOTH technologie de documentatie van het apparaat of de verkoper. In sommige landen geldt mogelijk een beperking op het gebruik van BLUETOOTH apparatuur. Controleer de wetgeving in het land van gebruik.

Onkyo Corporation garanterar inte BLUETOOTH kompatibilitet mellan AV-receiver och alla BLUETOOTH aktiverade enheter. För kompatibilitet mellan AV-receiver och en annan enhet med BLUETOOTH teknik, se enhetens dokumentation och återförsäljaren. I vissa länder kan det finnas begränsningar för användandet av BLUETOOTH enheter. Kontrollera hos de lokala myndigheterna.

لا تضمن Onkyo وجود توافق في البلوتوث (BLUETOOTH) بين مستقبل إشارات الصوت والصورة وجميع الأجهزة المزودة بالبلوتوث (BLUETOOTH). للتعرف على مدى التوافق بين مستقبل إشارات الصوت والصورة وأي جهاز آخر مزود بالبلوتوث (BLUETOOTH)، قد يبراجعة الوثائق المرافقة للجهاز أو أسأل الوكيل. قد تكون هناك قيودات على استخدام الأجهزة المزودة بالبلوتوث (BLUETOOTH). راجع السلطات المحلية.

### PANDORA

PANDORA, the PANDORA logo, and the Pandora trade dress are trademarks or registered trademarks of Pandora Media, Inc. Used with permission.



The product with this logo is conformed to Hi-Res Audio standard defined by Japan Audio Society. This logo is used under license from Japan Audio Society.

This product is protected by certain intellectual property rights of Microsoft. Use or distribution of such technology outside of this product is prohibited without a license from Microsoft.

Windows and the Windows logo are trademarks of the Microsoft group of companies.

QR Code is a registered trademark of DENSO WAVE INCORPORATED.

"x.v.Color" and "x.v.Color" logo are trademarks of Sony Corporation.

DSD and the Direct Stream Digital logo are trademarks of Sony Corporation.

MPEG Layer-3 audio coding technology licensed from Fraunhofer IIS and Thomson.

AccuEQ, Music Optimizer, RIHD and WRAT are trademarks of Onkyo Corporation.

"All other trademarks are the property of their respective owners."

"Toutes les autres marques commerciales sont la propriété de leurs détenteurs respectifs."

"El resto de marcas comerciales son propiedad de sus respectivos propietarios."

"Tutti gli altri marchi di fabbrica sono di proprietà dei rispettivi proprietari."

"Alle anderen Warenzeichen sind das Eigentum ihrer jeweiligen Eigentümer."

"Alle andere handelsmerken zijn eigendom van de desbetreffende rechthebbenden."

"Alla andra varumärken tillhör deras respektive ägare."

"جميع العلامات التجارية الأخرى مملوكة لأصحابها المعنيين."

## DISCLAIMER

---

Through this device you are able to link to other services or websites which are not under the control of any company which has designed, manufactured or distributed/have distributed this device, and its affiliates (collectively, "Company"). We have no control over the nature, content and availability of those services. The inclusion of any links does not necessarily imply a recommendation or endorse the views expressed within them.

All information, content and services available through this device belong to third parties and are protected by copyright, patent, trademark and/or other intellectual property laws of applicable countries.

The information, content and services provided through this device are for your personal, noncommercial use only. Any information, content or services may not be used in any manner other than previously approved by the appropriate content owner or service provider.

You may not modify, copy, republish, translate, exploit, create derivative works, upload, post, transmit, sell or distribute in any manner any information, content or services available through this device, unless expressly permitted by the appropriate copyright, patent, trademark and/or other intellectual property owner, including, without limitation, content owner or service provider.

THE CONTENT AND SERVICES AVAILABLE THROUGH THIS DEVICE ARE PROVIDED "AS IS".

COMPANY DOES NOT WARRANT INFORMATION, CONTENT OR SERVICES SO PROVIDED, EITHER EXPRESSLY OR IMPLIEDLY, FOR ANY PURPOSE.

COMPANY EXPRESSLY DISCLAIMS ANY WARRANTIES, EXPRESS OR IMPLIED, INCLUDING BUT NOT LIMITED TO, WARRANTIES OF TITLE, NON-INFRINGEMENT, MERCHANTABILITY OR FITNESS FOR A PARTICULAR PURPOSE.

Company makes no representation or warranty of any kind, express or implied, about the completeness, accuracy, validity, legality, reliability, suitability or availability with respect to the information, content or services available through this device. Company shall not be liable, whether in contract or tort, including negligence and strict liability, for any direct, indirect, special, incidental or consequential damages or any other damages arising out of, or in connection with, any information contained in, or as a result of the use of any content or service by you or any third party, even if Company has been advised of the possibility of such damages, nor shall Company be liable for any third party claims against users of this device or any third party.

In no event shall Company be responsible nor liable for, without limiting the generality of the foregoing, any interruption or suspension of any information, content or service available through this device. Company is neither responsible nor liable for customer service related to the information, content and services available through this device. Any question or request for service relating to the information, content or services should be made directly to the appropriate content owners and services providers.



# ONKYO

1-10-5 Yokoami, Sumida-ku, Tokyo 130-0015 JAPAN  
<http://www.onkyo.com/>

## <U.S.A.>

18 Park Way, Upper Saddle River, N.J. 07458, U.S.A.  
For Dealer, Service, Order and all other Business Inquiries:  
Tel: 201-785-2600 Fax: 201-785-2650  
<http://www.us.onkyo.com/>

For Product Support Team Only:  
1-800-229-1687  
<http://www.us.onkyo.com/>

## <Germany>

Gutenbergstrasse 3, 82178 Puchheim, Germany  
Tel: +49-8142-4401-0 Fax: +49-8142-4208-213  
<http://www.eu.onkyo.com/>

## <UK>

Anteros Building, Odyssey Business Park, West End Road, South Ruislip, Middlesex,  
HA4 6QQ United Kingdom  
Tel: +44 (0)871-200-1996 Fax: +44 (0)871-200-1995  
For Product Support only: +44 (0)208-836-3510  
<http://www.uk.onkyo.com/en/>

## <France>

6, Avenue de Marais F - 95816 Argenteuil Cedex FRANCE  
For Product Support only: +33 969 368 138  
<http://www.fr.onkyo.com/fr/>

## <Hong Kong>

Unit 1033, 10/F, Star House, No 3, Salisbury Road, Tsim Sha Tsui Kowloon, Hong Kong.  
Tel: +852-2429-3118 Fax: +852-2428-9039  
<http://www.hk.onkyo.com/>

## <PRC>

302, Building 1, 20 North Chaling Rd., Xuhui District, Shanghai, China 200032,  
Tel: +86-21-52131366 Fax: +86-21-52130396  
<http://www.cn.onkyo.com/>

## <Asia, Oceania, Middle East, Africa>

Please contact an Onkyo distributor referring to Onkyo SUPPORT site.  
<http://www.intl.onkyo.com/support/>

The above-mentioned information is subject to change without prior notice.  
Visit the Onkyo web site for the latest update.

