

ONKYO®

7.1ch Home Theater System

HT-S790

AV Receiver (HT-R540)

Front Speakers (SKF-540F)

Center Speaker (SKC-540C)

Surround Speakers (SKM-540S)

Surround Back Speakers (SKB-540)

Powered Subwoofer (SKW-540)

Instruction Manual

Thank you for purchasing an Onkyo 7.1ch Home Theater System. Please read this manual thoroughly before making connections and plugging in the unit. Following the instructions in this manual will enable you to obtain optimum performance and listening enjoyment from your new 7.1ch Home Theater System.

Please retain this manual for future reference.

Contents

Introduction 2

Connection 19

Turning On & First Time Setup..... 34

Basic Operation

Playing your AV components 36

Listening to the Radio 38

Enjoying the Listening Modes 46

Advanced Operation 52

Troubleshooting 61



WARNING:

TO REDUCE THE RISK OF FIRE OR ELECTRIC SHOCK, DO NOT EXPOSE THIS APPARATUS TO RAIN OR MOISTURE.

CAUTION:

TO REDUCE THE RISK OF ELECTRIC SHOCK, DO NOT REMOVE COVER (OR BACK). NO USER-SERVICEABLE PARTS INSIDE. REFER SERVICING TO QUALIFIED SERVICE PERSONNEL.



WARNING
RISK OF ELECTRIC SHOCK
DO NOT OPEN

AVIS
RISQUE DE CHOC ELECTRIQUE
NE PAS OUVRIR



The lightning flash with arrowhead symbol, within an equilateral triangle, is intended to alert the user to the presence of uninsulated “dangerous voltage” within the product’s enclosure that may be of sufficient magnitude to constitute a risk of electric shock to persons.



The exclamation point within an equilateral triangle is intended to alert the user to the presence of important operating and maintenance (servicing) instructions in the literature accompanying the appliance.

Important Safety Instructions

1. Read these instructions.
2. Keep these instructions.
3. Heed all warnings.
4. Follow all instructions.
5. Do not use this apparatus near water.
6. Clean only with dry cloth.
7. Do not block any ventilation openings. Install in accordance with the manufacturer’s instructions.
8. Do not install near any heat sources such as radiators, heat registers, stoves, or other apparatus (including amplifiers) that produce heat.
9. Do not defeat the safety purpose of the polarized or grounding-type plug. A polarized plug has two blades with one wider than the other. A grounding type plug has two blades and a third grounding prong. The wide blade or the third prong are provided for your safety. If the provided plug does not fit into your outlet, consult an electrician for replacement of the obsolete outlet.
10. Protect the power cord from being walked on or pinched particularly at plugs, convenience receptacles, and the point where they exit from the apparatus.
11. Only use attachments/accessories specified by the manufacturer.
12. Use only with the cart, stand, tripod, bracket, or table specified by the manufacturer, or sold with the apparatus. When a cart is used, use caution when moving the cart/apparatus combination to avoid injury from tip-over.

PORTABLE CART WARNING
S3125A
13. Unplug this apparatus during lightning storms or when unused for long periods of time.
14. Refer all servicing to qualified service personnel. Servicing is required when the apparatus has been damaged in any way, such as power-supply cord or plug is damaged, liquid has been spilled or objects have fallen into the apparatus, the apparatus has been exposed to rain or moisture, does not operate normally, or has been dropped.
15. Damage Requiring Service
Unplug the apparatus from the wall outlet and refer servicing to qualified service personnel under the following conditions:
 - A. When the power-supply cord or plug is damaged,
 - B. If liquid has been spilled, or objects have fallen into the apparatus,
 - C. If the apparatus has been exposed to rain or water,
 - D. If the apparatus does not operate normally by following the operating instructions. Adjust only those controls that are covered by the operating instructions as an improper adjustment of other controls may result in damage and will often require extensive work by a qualified technician to restore the apparatus to its normal operation,
 - E. If the apparatus has been dropped or damaged in any way, and
 - F. When the apparatus exhibits a distinct change in performance this indicates a need for service.
16. Object and Liquid Entry
Never push objects of any kind into the apparatus through openings as they may touch dangerous voltage points or short-out parts that could result in a fire or electric shock.
The apparatus shall not be exposed to dripping or splashing and no objects filled with liquids, such as vases shall be placed on the apparatus.
Don’t put candles or other burning objects on top of this unit.
17. Batteries
Always consider the environmental issues and follow local regulations when disposing of batteries.
18. If you install the apparatus in a built-in installation, such as a bookcase or rack, ensure that there is adequate ventilation.
Leave 20 cm (8") of free space at the top and sides and 10 cm (4") at the rear. The rear edge of the shelf or board above the apparatus shall be set 10 cm (4") away from the rear panel or wall, creating a flue-like gap for warm air to escape.

Precautions

1. **Recording Copyright**—Unless it's for personal use only, recording copyrighted material is illegal without the permission of the copyright holder.
2. **AC Fuse**—The AC fuse inside the unit is not user-serviceable. If you cannot turn on the unit, contact your Onkyo dealer.
3. **Care**—Occasionally you should dust the unit all over with a soft cloth. For stubborn stains, use a soft cloth dampened with a weak solution of mild detergent and water. Dry the unit immediately afterwards with a clean cloth. Don't use abrasive cloths, thinners, alcohol, or other chemical solvents, because they may damage the finish or remove the panel lettering.
4. **Power**
WARNING
BEFORE PLUGGING IN THE UNIT FOR THE FIRST TIME, READ THE FOLLOWING SECTION CAREFULLY.
AC outlet voltages vary from country to country. Make sure that the voltage in your area meets the voltage requirements printed on the unit's rear panel (e.g., AC 230–240 V, 50 Hz or AC 120 V, 60 Hz).
Pressing the [STANDBY/ON] button to select Standby mode does not fully shutdown the unit. If you do not intend to use the unit for an extended period, remove the power cord from the AC outlet.
5. **Never Touch this Unit with Wet Hands**—Never handle this unit or its power cord while your hands are wet or damp. If water or any other liquid gets inside this unit, have it checked by your Onkyo dealer.
6. **Handling Notes**
 - If you need to transport this unit, use the original packaging to pack it how it was when you originally bought it.
 - Do not leave rubber or plastic items on this unit for a long time, because they may leave marks on the case.
 - This unit's top and rear panels may get warm after prolonged use. This is normal.
 - If you do not use this unit for a long time, it may not work properly the next time you turn it on, so be sure to use it occasionally.

For U.S. models

FCC Information for User

CAUTION:

The user changes or modifications not expressly approved by the party responsible for compliance could void the user's authority to operate the equipment.

NOTE:

This equipment has been tested and found to comply with the limits for a Class B digital device, pursuant to Part 15 of the FCC Rules. These limits are designed to provide reasonable protection against harmful interference in a residential installation.

This equipment generates, uses and can radiate radio frequency energy and, if not installed and used in accordance with the instructions, may cause harmful interference to radio communications. However, there is no guarantee that interference will not occur in a particular installation. If this equipment does cause harmful interference to radio or television reception, which can be determined by turning the equipment off and on, the user is encouraged to try to correct the interference by one or more of the following measures:

- Reorient or relocate the receiving antenna.
- Increase the separation between the equipment and receiver.
- Connect the equipment into an outlet on a circuit different from that to which the receiver is connected.
- Consult the dealer or an experienced radio/TV technician for help.

For Canadian Models

NOTE: THIS CLASS B DIGITAL APPARATUS COMPLIES WITH CANADIAN ICES-003.

For models having a power cord with a polarized plug:

CAUTION: TO PREVENT ELECTRIC SHOCK, MATCH WIDE BLADE OF PLUG TO WIDE SLOT, FULLY INSERT.

Modèle pour les Canadiens

REMARQUE: CET APPAREIL NUMÉRIQUE DE LA CLASSE B EST CONFORME À LA NORME NMB-003 DU CANADA.

Sur les modèles dont la fiche est polarisée:

ATTENTION: POUR ÉVITER LES CHOCS ÉLECTRIQUES, INTRODUIRE LA LAME LA PLUS LARGE DE LA FICHE DANS LA BORNE CORRESPONDANTE DE LA PRISE ET POUSSER JUSQU'AU FOND.

Speaker Precautions

Placement

- The speaker cabinets are made out of wood and are therefore sensitive to extreme temperatures and humidity, do not put them in locations subject to direct sunlight or in humid places, such as near an air conditioner, humidifier, bathroom, or kitchen.
- Do not put water or other liquids close to the speakers. If liquid is spilled over the speakers, the drive units may be damaged.
- Speakers should only be placed on sturdy, flat surfaces that are free from vibration. Putting them on uneven or unstable surfaces, where they may fall and cause damage, will affect the sound quality.
- Subwoofer is designed to be used in the upright vertical position only. Do not use it in the horizontal or tilted position.
- If the unit is used near a turntable, CD player or DVD player, howling or slipping of sound may occur. To prevent this, move the unit away from the turntable, CD player or DVD player otherwise lower the unit's output level.

Using Close to a TV or Computer

TVs and computer monitors are magnetically sensitive devices and as such are likely to suffer discoloration or picture distortion when conventional speakers are placed nearby. To prevent this, the SKF-540F and SKC-540C feature internal magnetic shielding. In some situations, however, discoloration may still be an issue, in which case you should turn off your TV or monitor, wait 15 to 30 minutes, and then turn it back on again. This normally activates the degaussing function, which neutralizes the magnetic field, thereby removing any discoloration effects. If discoloration problems persist, try moving the speakers away from your TV or monitor. Note that discoloration can also be caused by a magnet or demagnetizing tool that's too close to your TV or monitor.

Input Signal Warning

The speakers can handle the specified input power when used for normal music reproduction. If any of the following signals are fed to them, even if the input power is within the specified rating, excessive current may flow in the speaker coils, causing burning or wire breakage:

1. Interstation noise from an untuned FM radio.
2. Sound from fast-forwarding a cassette tape.
3. High-pitched sounds generated by an oscillator, electronic musical instrument, and so on.
4. Amplifier oscillation.
5. Special test tones from audio test CDs and so on.
6. Thumps and clicks caused by connecting or disconnecting audio cables (Always turn off your amplifier before connecting or disconnecting cables.)
7. Microphone feedback.

Enjoying Home Theater

Speaker Sets A and B

You can use two sets of speakers with the AV receiver: *speaker set A* and *speaker set B*.

Speaker set A (included speakers) should be used in your main listening room for up to 7.1-channel playback.

*While speaker set B is on, speaker set A is reduced to 5.1-channel playback.

Speaker set B (not included) can be used in another room and offers 2-channel stereo playback.

*Only analog input sources are output by speaker set B.

AV receiver



or

Remote controller



Speaker set A	Speaker set B	Indicator	Output
On	On	A B	Set A: 5.1 channels Set B: 2 channels
	Off	A	Set A: 7.1 channels
Off	On	B	Set B: 2 channels
	Off		No sound

Speaker Set A: Main Room

Front left and right speakers (SKF-540F)

These output the overall sound. Their role in a home theater is to provide a solid anchor for the sound image. They should be positioned facing the listener at about ear level, and equally spaced from the TV. Angle them inward.

Center speaker (SKC-540C)

This speaker enhances the front left and right speakers, making sound movements distinct and providing a full sound image. For movies it's used mainly for dialog. Position it close to your TV facing forward at about ear level, or at the same height as the front left and right speakers.

Subwoofer (SKW-540)

The subwoofer handles the bass sounds of the LFE (Low-Frequency Effects) channel. In general, a good bass sound can be obtained by installing the subwoofer in a front corner, or at one-third the way along the wall, as shown.

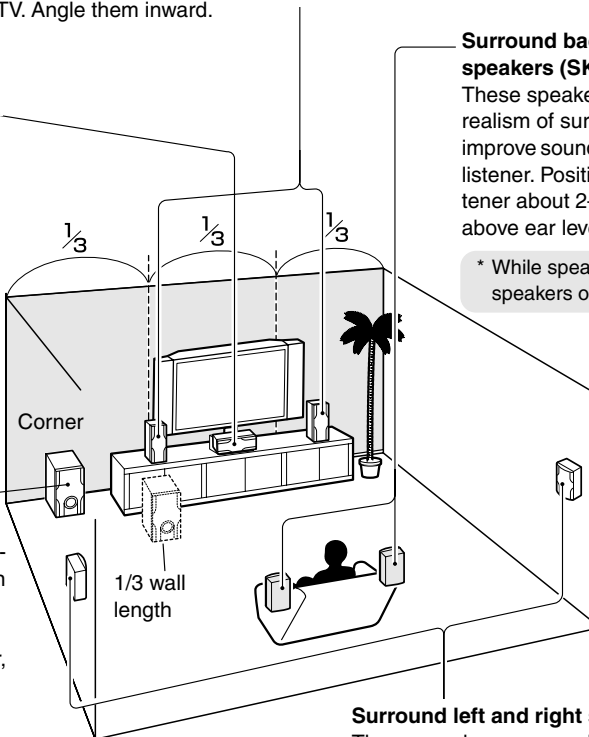

Surround back left and right speakers (SKB-540)

These speakers further enhance the realism of surround sound and improve sound localization behind the listener. Position them behind the listener about 2–3 feet (60–100 cm) above ear level.

* While speaker set B is on, these speakers output no sound.

Surround left and right speakers (SKM-540S)

These speakers are used for precise sound positioning and to add realistic ambience. Position them at the sides of the listener, or slightly behind, about 2–3 feet (60–100 cm) above ear level. Ideally they should be equally spaced from the listener.

Speaker Set B: Sub Room

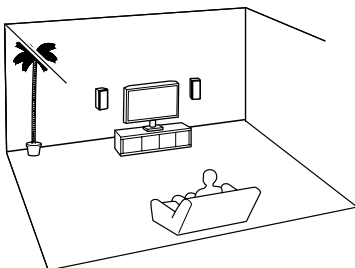

Package Contents

Make sure you have the following items:

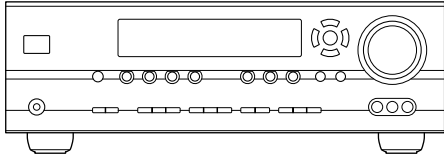

AV receiver (HT-R540)

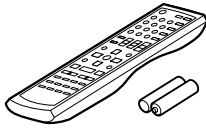

Remote controller & two batteries (AA/R6)

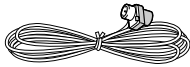

Indoor FM antenna



AM loop antenna

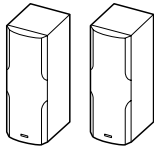

Front speakers (SKF-540F)

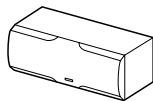

Center speaker (SKC-540C)

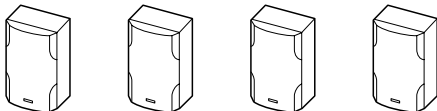

**Surround and Surround back speakers
(SKM-540S/SKB-540)**

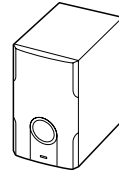

Subwoofer (SKW-540)

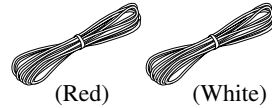

Speaker cable for front speakers 15 ft. (4.5 m)



Speaker cable for center speaker 10 ft. (3 m)

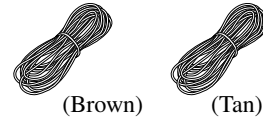
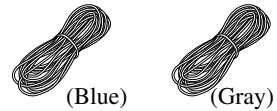

Speaker cables for surround speakers 30 ft. (9 m)



RCA cable for subwoofer connection 10 ft. (3 m)

* In catalogs and on packaging, the letter at the end of the product name indicates the color. Specifications and operation are the same regardless of color.

Features

Amplifier

- 7-channel amplifier
- 110 watts per channel rms into 8 ohms, 2 channels driven at 1 kHz, less than 0.9% total harmonic distortion (FTC rating)
- WRAT (Wide Range Amplifier Technology)
- Optimum Gain Volume Circuitry
- OR-EQ (OptiResponse Equalizer)^{*1} function

Processing

- Dolby^{*2} Digital EX and Dolby Pro Logic IIx
- DTS, DTS-ES Matrix/Discrete, DTS Neo:6, and DTS 96/24^{*3}
- Neural Surround^{*4} (North American models only)
- CinemaFILTER function
- Linear PCM 192 kHz/24-bit D/A converters on all channels
- Pure Audio listening mode (not North American model)
- Powerful and highly accurate 32-bit DSP processing

Audio/Video

- Adjustable crossover (40, 50, 60, 80, 100, 120, 150, 200 Hz)
- HDTV-capable component video (3 inputs, 1 output)
- 3 S-Video inputs, 2 outputs
- 4 assignable digital inputs (3 optical, 1 coaxial)
- Subwoofer pre out
- Color-coded 7.1 multichannel input for use with Super Audio CD and DVD-Audio
- A/B speaker drive
- Color-coded speaker terminal posts

Tuner

- XM^{*5} Satellite Radio (North American models only)
*XM Passport System required; sold separately.
- 40 AM/FM/XM presets
- AM/FM auto tuning

Remote Controller

- Preprogrammed for use with other AV components

Speaker

- Color-coded speaker terminals and speaker cables
- Subwoofer Auto standby function
- Magnetically shielded front and center speakers
- Floating tweeter on the front and center speakers

*1 OptiResponse, and OR-EQ are trademarks of Onkyo Corporation.



*2 Manufactured under license from Dolby Laboratories. "Dolby", "Pro Logic" and the double-D symbol are registered trademarks of Dolby Laboratories.



*3 "DTS," "DTS 96/24," "DTS-ES," and "Neo:6" are trademarks of Digital Theater Systems, Inc.



*4 Neural Surround name and related logos are trademarks owned by Neural Audio Corporation.



*5 XM Ready[®], XM Public Radio[™] are trademarks of XM Satellite Radio Inc. ©2005 XM Satellite Radio Inc. All rights reserved. All other trademarks are the property of their respective owners.

Getting Started in Five Easy Steps

1. Hookup

Connect the AV receiver to your AV system.

➤ page 19

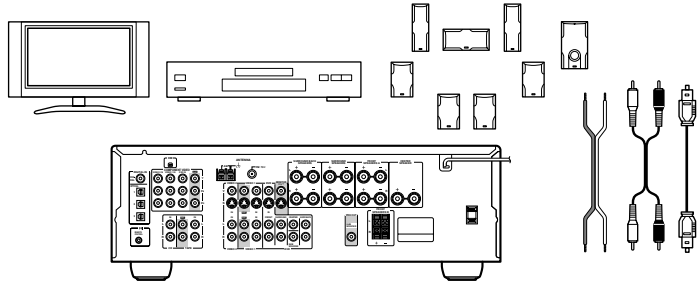

2. Turning On

With the hookup complete, you're ready to switch on.

➤ page 34

3. First Time Setup

A few simple settings to get the very best from your system.

➤ page 35

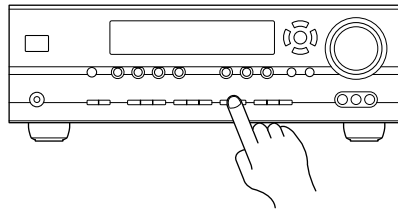

Digital Input

Input Display

4. Playing Your AV Components

Enjoying movies and music.

➤ page 36

5. Using the Listening Modes

Time to really enjoy your home theater system!

➤ page 46

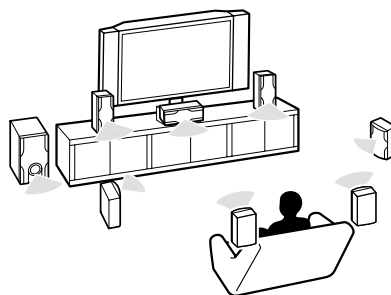

Contents

Introduction

Important Safety Instructions	2
Precautions	3
Speaker Precautions	4
Enjoying Home Theater	5
Speaker Sets A and B	5
Package Contents	6
Features	7
Getting to Know the AV Receiver	10
Remote Controller	13
Speakers	18

Connection

Connecting Your Speakers	19
Connecting Antennas	20
Connecting Your Components	22
About AV Connections	22
Connecting Audio and Video Signals to the AV Receiver	23
Which Connections Should I Use?	23
TV or Projector	24
DVD player	25
VCR or DVD Recorder for Playback	27
VCR or DVD Recorder for Recording	28
Camcorder, Games Console, or Other Device	28
Satellite, Cable, Set-top box, or Other Video Source	29
CD Player or Turntable	30
HDD-compatible Component	31
Cassette, CDR, MiniDisc, or DAT Recorder	32
Connecting the Power Cord of Another Component	32
Connecting Onkyo RI Components	33
Connecting the Power Cord	33

Turning On & First Time Setup

Turning On the AV Receiver	34
First Time Setup	35
Assigning Digital Inputs to Input Sources	35
Changing the Input Display	35

Basic Operation

Playing Your AV Components	36
Basic AV Receiver Operation	36
Using the Multichannel DVD Input	37
Displaying Source Information	37
Listening to the Radio	38
Listening to AM/FM stations	38
Presetting AM/FM Stations and XM Channels	39
Listening to XM Satellite Radio® (North American Models Only)	40
Common Functions	44
Setting the Display Brightness	44
Adjusting the Bass and Treble	44
Muting the AV Receiver	44
Using the OptiResponse Equalizer	44
Using the Sleep Timer	45
Using Headphones	45
Adjusting Speaker Levels	45

Enjoying the Listening Modes

Using the Listening Modes	46
Selecting Listening Modes	46
About the Listening Modes	48
Using the Late Night Function	50
Using the CinemaFILTER	50
Using the Audio Adjust Settings	50

Advanced Operation

Advanced Setup	52
Advanced Speaker Settings	52
Digital Input Signal Formats	56
Correcting Sound and Picture Sync	56
Recording	57
Controlling Other Components	58
Entering Remote Control Codes	58
Remote Control Codes for Onkyo Components Connected via RI	59
Resetting REMOTE MODE Buttons	59
Resetting the Remote Controller	59

Troubleshooting	61
If you can't resolve an issue, try resetting the AV receiver by holding down the [VIDEO 1] button and pressing the [STANDBY/ON] button.	

Specifications	65
----------------------	----

Getting to Know the AV Receiver

Front Panel

North American Model

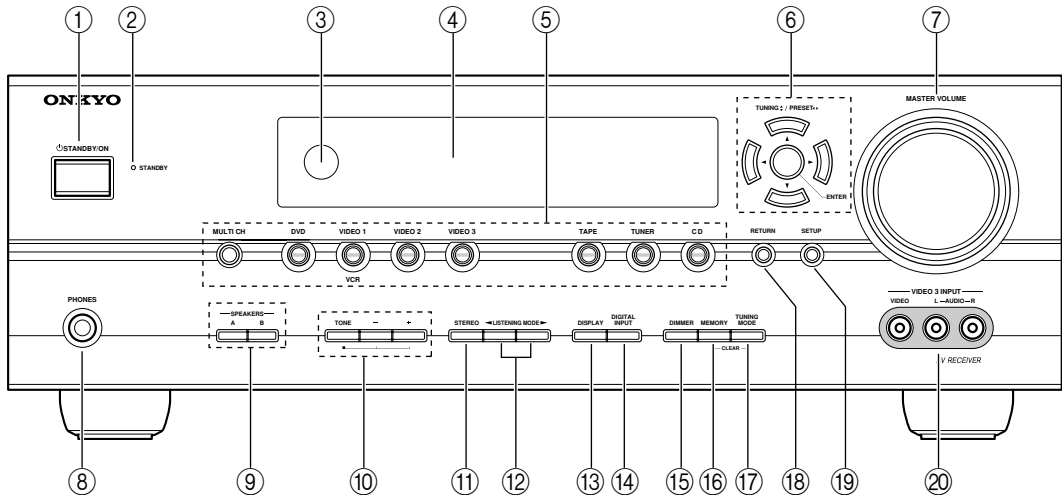

Other Models

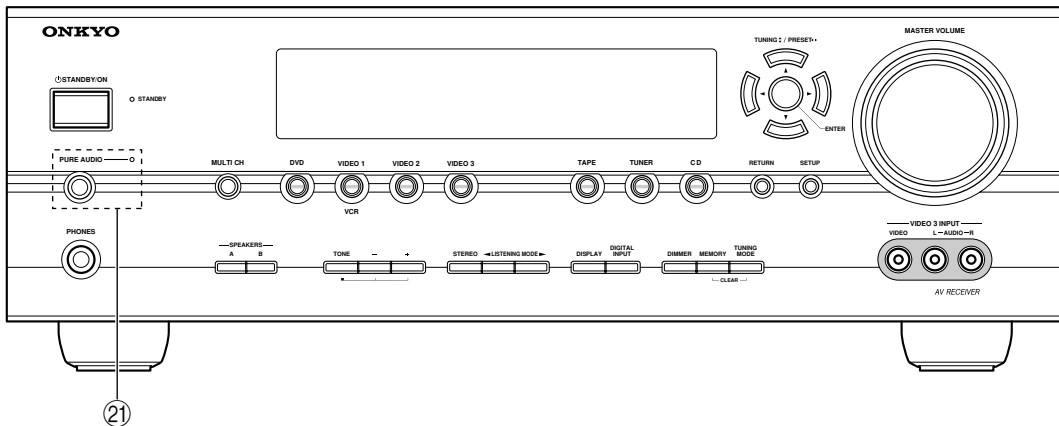

For detailed information, see the pages in parentheses.

- ① **STANDBY/ON button (34)**
Sets the AV receiver to On or Standby.
- ② **STANDBY indicator (34)**
Lights up when the AV receiver is on Standby and flashes while a signal is being received from the remote controller.
- ③ **Remote-control sensor (13)**
Receives control signals from the remote controller.
- ④ **Display**
See “Display” on page 11.
- ⑤ **Input selector buttons (36)**
Select the input sources.
The [MULTI CH] button selects the multichannel DVD input.
- ⑥ **Arrow/TUNING/PRESET and ENTER buttons**
When AM, FM, or XM is selected, the TUNING [▲] [▼] buttons are used for radio tuning, and the PRESET [◀] [▶] buttons are used to select radio presets (see page 39). With the setup menus, they work as arrow buttons and are used to select and set items. The ENTER button is also used with the setup menus.
- ⑦ **MASTER VOLUME control (36)**
Sets the volume of the AV receiver to MIN, 1 through 79, or MAX.
- ⑧ **PHONES jack (45)**
This 1/4-inch phone jack is for connecting a standard pair of stereo headphones for private listening.
- ⑨ **SPEAKERS A and B buttons (5, 36)**
Turn speaker sets A and B on or off.

Getting to Know the AV Receiver—Continued

- ⑩ **TONE, [-], and [+] buttons (44)**
Used to adjust the bass and treble.
- ⑪ **STEREO button (46)**
Selects the Stereo listening mode.
- ⑫ **LISTENING MODE [◀]/[▶] buttons (46)**
Select the listening modes.
- ⑬ **DISPLAY button (37)**
Displays various information about the currently selected input source.
- ⑭ **DIGITAL INPUT button (35, 56)**
Used to assign the digital inputs and to specify the format of digital input signals.
- ⑮ **DIMMER button (44)**
Adjusts the display brightness.
- ⑯ **MEMORY button (39)**
Used when storing or deleting radio presets.
- ⑰ **TUNING MODE button (38)**
Selects the Auto or Manual tuning mode for AM and FM radio.
- ⑱ **RETURN button**
Selects the previously displayed setup menu.
- ⑲ **SETUP button**
Used to access the setup menus.
- ⑳ **VIDEO 3 INPUT (28, 57)**
Used to connect a camcorder, games console, and so on. There are jacks for composite video and analog audio.
- ㉑ **PURE AUDIO button and indicator (46)**
The North American model doesn't have this button and indicator.
Selects the Pure Audio listening mode. The indicator lights up when this mode is selected.

Display

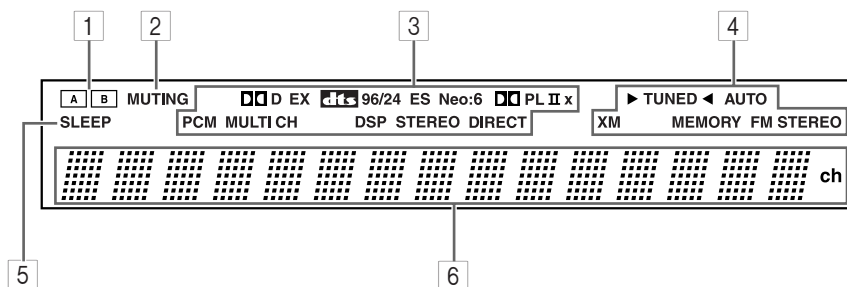

For detailed information, see the pages in parentheses.

- ① **A and B speaker indicators (5, 36)**
Indicator A lights up when speaker set A is on. Indicator B lights up when speaker set B is on.
- ② **MUTING indicator (44)**
Flashes while the AV receiver is muted.
- ③ **Listening mode and format indicators (48)**
Show the selected listening mode and the format of digital audio signals.
- ④ **Radio indicators**
 - TUNED (38):** Lights up when tuned to a radio station.
 - AUTO (38):** For AM and FM radio, lights up when Auto Tuning is selected, and disappears when Manual Tuning mode is selected.
 - XM (North American models only) (40):**
Lights up when XM radio is selected.
- ⑤ **SLEEP indicator (45)**
Lights up when the Sleep function has been set.
- ⑥ **Message area**
Displays various information about the selected input source.
- ⑤ **MEMORY (39):** Lights up when presetting radio stations.
- ⑤ **FM STEREO (38):** Lights up when tuned to a stereo FM station.

Rear Panel

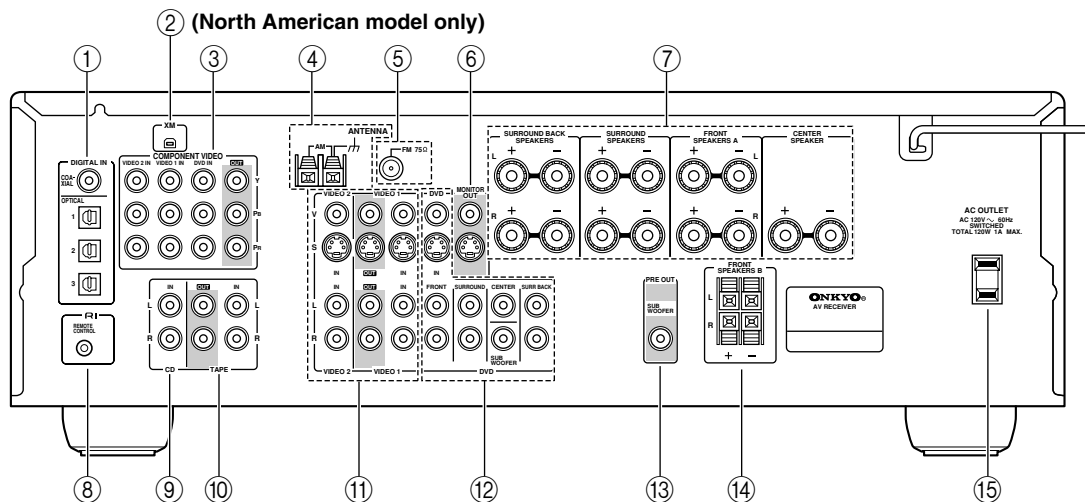

① **DIGITAL IN OPTICAL 1, 2, 3, and COAXIAL**
These optical and coaxial digital audio inputs are for connecting components with optical or coaxial digital audio outputs, such as CD and DVD players.

② **XM antenna (on North American models)**
This jack is for connecting an XM Passport System, sold separately (see page 40).

③ **COMPONENT VIDEO**
A DVD player, TV, or other component that supports component video can be connected here.

④ **AM ANTENNA**
These push terminals are for connecting an AM antenna.

⑤ **FM ANTENNA**
This jack is for connecting an FM antenna.

⑥ **MONITOR OUT**
The S-Video or composite video output should be connected to a video input on your TV or projector.

⑦ **FRONT SPEAKERS A, SURROUND SPEAKERS, CENTER SPEAKER, and SURROUND BACK SPEAKERS**
These terminal posts are for connecting speaker set A.

⑧ **RI REMOTE CONTROL**
This **RI** Remote Interactive jack can be connected to the **RI** jack on another **RI**-capable Onkyo component. To use **RI**, you must make an analog audio connection (RCA) between the AV receiver and the other component, even if they are connected digitally.

⑨ **CD IN**
This analog audio input is for connecting a CD player's analog audio output.

⑩ **TAPE IN/OUT**
This analog audio input and output are for connecting a recorder with an analog audio input and output, such as a cassette deck, MD recorder, etc.

⑪ **VIDEO 1 IN/OUT and VIDEO 2 IN**
The VIDEO 1 inputs and outputs can be used to connect a VCR. The VIDEO 2 inputs can be used to connect another video source (e.g., cable/satellite receiver, set-top box, etc).

⑫ **DVD IN**
These jacks can be used to connect a DVD player with an analog multichannel audio output for SACD and DVD-Audio playback.

⑬ **SUBWOOFER PRE OUT**
A powered subwoofer can be connected here.

⑭ **FRONT SPEAKERS B**
These push terminals are for connecting speaker set B.

⑮ **AC OUTLET**
This switched AC outlet can be used to supply power to another AV component. The type of outlet depends on the country in which you purchased your AV receiver.

See pages 19–33 for hookup information.

Remote Controller

Installing the Batteries

- 1 To open the battery compartment, press the small hollow and slide open the cover.**

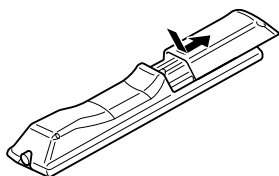

- 2 Insert the two supplied batteries (AA/R6) in accordance with the polarity diagram inside the battery compartment.**

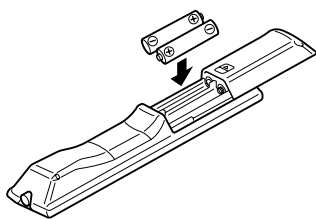

- 3 Slide the cover shut.**

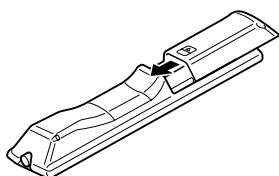

Notes:

- If the remote controller doesn't work reliably, try replacing the batteries.
- Don't mix new and old batteries or different types of batteries.
- If you intend not to use the remote controller for a long time, remove the batteries to prevent damage from leakage or corrosion.
- Expired batteries should be removed as soon as possible to prevent damage from leakage or corrosion.

Aiming the Remote Controller

When using the remote controller, point it toward the AV receiver's remote control sensor, as shown below.

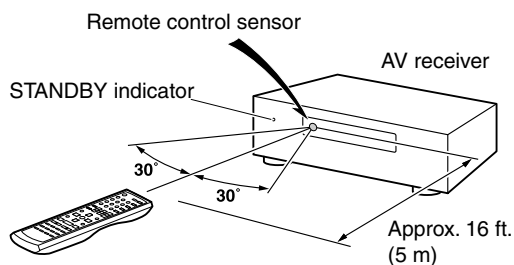

Notes:

- The remote controller may not work reliably if the AV receiver is subjected to bright light, such as direct sunlight or inverter-type fluorescent lights. Keep this in mind when installing.
- If another remote controller of the same type is used in the same room, or the AV receiver is installed close to equipment that uses infrared rays, the remote controller may not work reliably.
- Don't put anything on top of the remote controller, such as a book or magazine, because a button may be pressed continuously, thereby draining the batteries.
- The remote controller may not work reliably if the AV receiver is installed in a rack behind colored glass doors. Keep this in mind when installing.
- The remote controller will not work if there's an obstacle between it and the AV receiver's remote control sensor.

Using the Remote Controller

Including the AV receiver, the remote controller can be used to control up to seven different components. The remote controller has a specific operating mode for use with each type of component. Modes are selected by using the six REMOTE MODE buttons.

RECEIVER/TAPE Mode

In RECEIVER/TAPE mode, you can control the AV receiver and an Onkyo cassette recorder connected via **RI**.

DVD and CD/MD/CDR/HDD Modes

With these modes, you can control a DVD player and CD, MD, CDR, or HDD player or recorder. By entering the appropriate remote control code, you can control Onkyo components or components made by other manufacturers (see page 58).

TV, VCR and SAT/CABLE Modes

With these modes, you can control a TV, VCR, and satellite or cable receiver. You must enter the appropriate remote control code first (see page 58).

1 Press one of the REMOTE MODE buttons to select a mode.

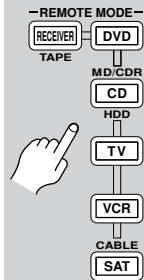

2 Use the buttons supported by that mode to control the component.

- RECEIVER/TAPE mode: see right column
- DVD mode: see page 16
- CD/MD/CDR/HDD mode: see page 17
- TV, VCR, SAT/CABLE mode: see page 60

Note:

Some of the remote controller operations described in this manual may not work as expected with other components.

RECEIVER/TAPE Mode

RECEIVER/TAPE mode is used to control the AV receiver. It can also be used to control an Onkyo cassette recorder connected via **RI**.

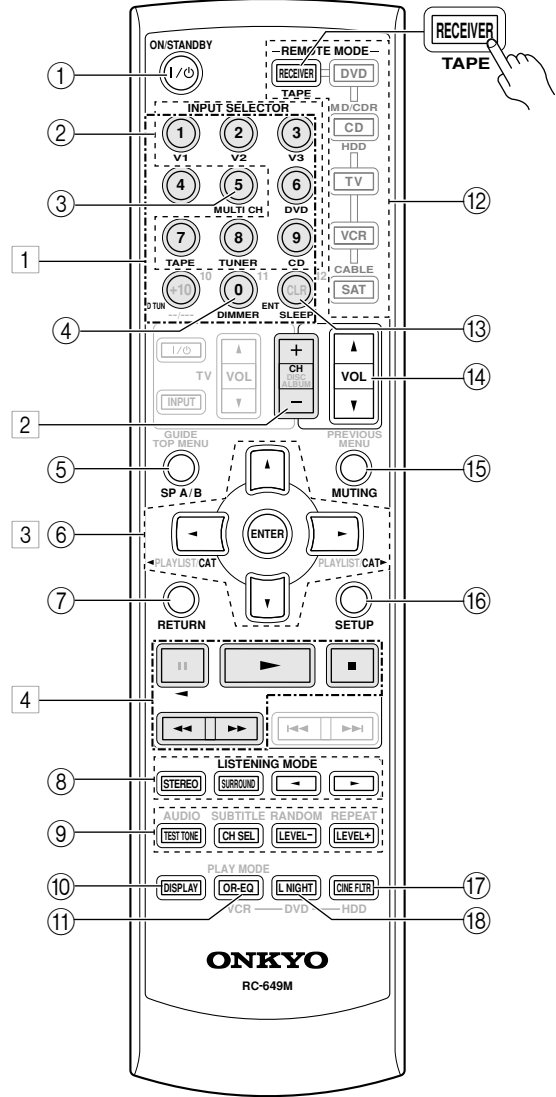

Buttons **1**, **2**, **3**, and **4** are used when the TUNER or TAPE input is selected.

Remote Controller—Continued

For detailed information, see the pages in parentheses.

- ① **ON/STANDBY button (34)**
Sets the AV receiver to On or Standby.
- ② **INPUT SELECTOR buttons (36)**
Used to select the input sources.
- ③ **MULTI CH button (37)**
Selects the multichannel DVD input.
- ④ **DIMMER button (44)**
Adjusts the display brightness.
- ⑤ **SP A/B button (5, 36)**
Used to turn speaker sets A and B on or off.
- ⑥ **Arrow [▲]/[▼]/[◀]/[▶] and ENTER buttons**
Used to select and adjust settings.
- ⑦ **RETURN button**
Selects the previously displayed setup menu.
- ⑧ **LISTENING MODE buttons (46)**
Used to select the listening modes. These buttons work in all remote controller modes.
STEREO button
Selects the Stereo listening mode.
SURROUND button
Selects the Dolby and DTS listening modes and the Neural Surround listening mode (North American model only).
[◀]/[▶] buttons
Used to select the available listening modes.
- ⑨ **TEST TONE, CH SEL, LEVEL-, and LEVEL+ buttons (34, 45, 53)**
Used to adjust the level of each speaker.
- ⑩ **DISPLAY button (37)**
Displays various information about the selected input source.
- ⑪ **OR-EQ button (44)**
Turns on the OptiResponse Equalizer, which optimizes performance when the HT-R540 is used with the speakers included in this package. When the OptiResponse Equalizer is on, you can enjoy a powerful sound with movies or music even at low volume levels.
- ⑫ **REMOTE MODE buttons (14)**
Used to select the remote controller modes. When a remote controller button is pressed, the REMOTE MODE button for the currently selected mode lights up.
- ⑬ **SLEEP button (45)**
Used with the Sleep function.
- ⑭ **VOL [▲]/[▼] button (36)**
Adjusts the volume of the AV receiver regardless of the currently selected remote controller mode.
- ⑮ **MUTING button (44)**
Mutes or unmutes the AV receiver.

- ⑯ **SETUP button**
Used to access the setup menus.
- ⑰ **CINE FLTR button (50)**
Used with the CinemaFILTER function.
- ⑱ **L NIGHT button (50)**
Used with the Late Night function.

■ Buttons used when the TUNER input is selected

To select the Tuner (AM/FM/XM) as the input source, press:



- 1 **Number, D TUN, and ENT buttons (39, 41)**
Used to select AM and FM radio stations and XM radio channels directly.
- 2 **CH +/- button (39)**
Used to select radio presets.
- 3 **Arrow [▲]/[▼]/[◀]/[▶] and ENTER buttons**
For AM and FM, the Up and Down [▲]/[▼] buttons are used for tuning.
North American model only
For XM, the Up and Down [▲]/[▼] buttons are used to select channels, and the [ENTER] button is used to change the search mode. The Left and Right [◀]/[▶] buttons are used to select categories.

■ Buttons used when the TAPE input is selected

To select your Cassette deck as the input source, press:



- 4 **Playback buttons**
On twin cassette decks, only deck B can be controlled.
Play [▶] button
Starts playback.
Stop [■] button
Stops playback.
Reverse Play [◀] button
Starts reverse playback.
Rewind and FF [◀◀]/[▶▶] buttons
The Rewind [◀◀] button starts rewind. The FF [▶▶] button starts fast forward.

DVD Mode

By default, the remote controller is set to control an Onkyo DVD player.

To select your DVD player as the input source, press:

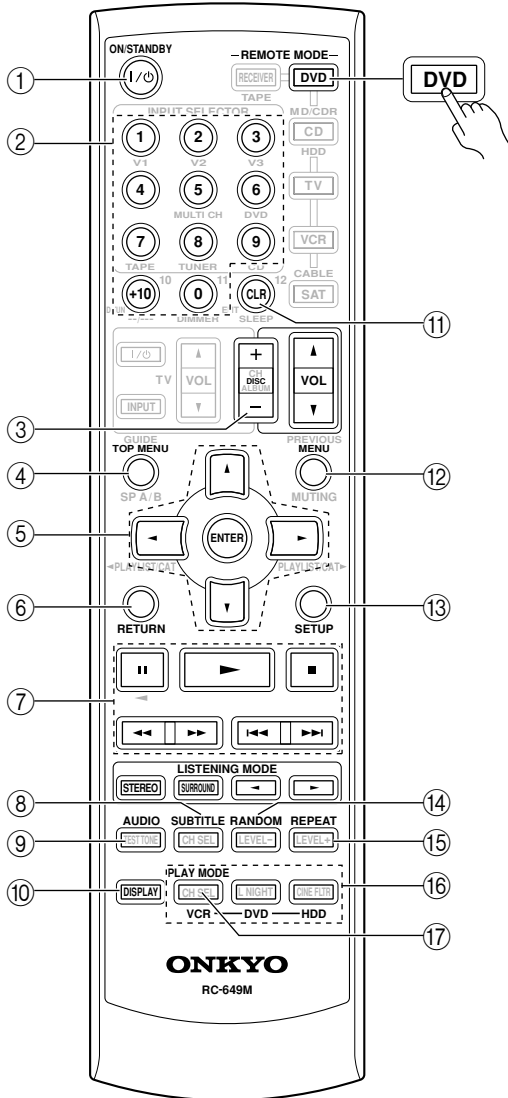

- ① **ON/STANDBY button**
Sets the DVD player to On or Standby.
- ② **Number buttons**
Used to enter title, chapter, and track numbers and times for locating specific points.
- ③ **DISC +/- button**
Selects discs on a DVD changer.
- ④ **TOP MENU button**
Selects a DVD's top menu.
- ⑤ **Arrow [▲]/[▼]/[◀]/[▶] and ENTER buttons**
Used to navigate DVD menus and the DVD player's onscreen setup menus.
- ⑥ **RETURN button**
Exits the DVD player's onscreen setup menus.
- ⑦ **Playback buttons**
From left to right: Pause, Play, Stop, Fast Reverse, Fast Forward, Previous, and Next.
- ⑧ **SUBTITLE button**
Selects subtitles.
- ⑨ **AUDIO button**
Selects foreign language soundtracks and audio formats (e.g., Dolby Digital or DTS).
- ⑩ **DISPLAY button**
Displays information about the current disc, title, chapter, or track, including elapsed time, remaining time, total time, and so on.
- ⑪ **CLR button**
Cancels functions and clears entered numbers.
- ⑫ **MENU button**
Displays a DVD's menu.
- ⑬ **SETUP button**
Used to access the DVD player's onscreen setup menus.
- ⑭ **RANDOM button**
Used with the random playback function.
- ⑮ **REPEAT button**
Used with the repeat playback functions.
- ⑯ **VCR, DVD, and HDD buttons**
Used to select VCR, HDD (hard disk drive), or DVD playback on a VCR/DVD recorder with a built-in hard disk drive.
- ⑰ **PLAY MODE button**
Selects play modes on components with selectable play modes.

CD/MD/CDR/HDD Mode

By default, the remote controller is set to control an Onkyo CD player.

To select the input source, press:



* If you're using an MD, CDR, or HDD component, you must change the Input Display (see page 35).

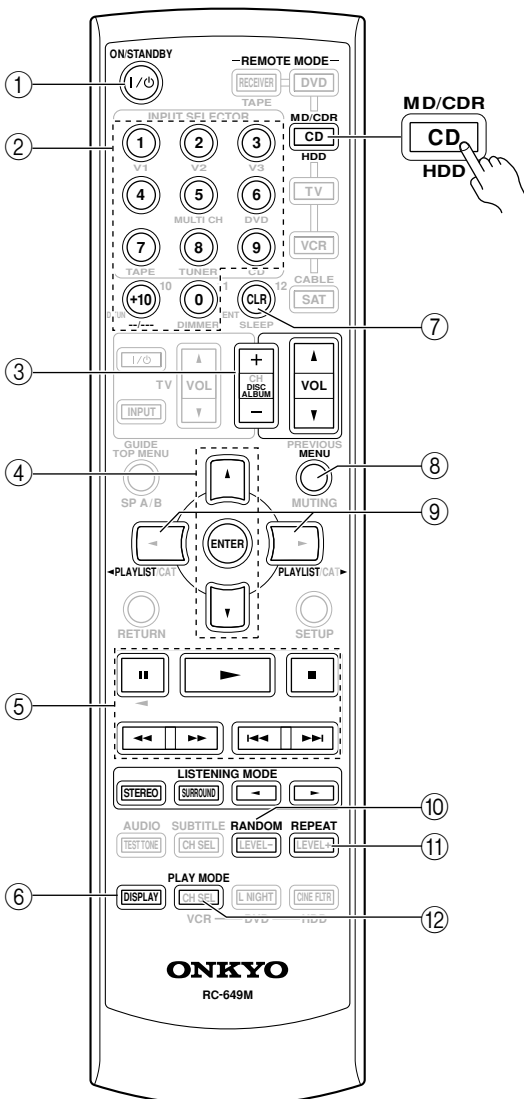

- ① **ON/STANDBY button**
Sets the component to On or Standby.
- ② **Number buttons**
Used to enter track numbers and times for locating specific points on CD/MD players.
- ③ **DISC/ALBUM +/- button**
Selects discs on a CD changer, or the next or previous album on an HDD-compatible component.
- ④ **Arrow [▲]/[▼] and ENTER buttons**
Used to navigate menus on an HDD-compatible component.
- ⑤ **Playback buttons**
From left to right: Pause, Play, Stop, Fast Reverse, Fast Forward, Previous and Next.
- ⑥ **DISPLAY button**
Displays information about the current disc or track on a CD player or MD/CD recorder, including elapsed time, remaining time, total time, and so on. On an HDD-compatible component, it turns on the back light for 30 seconds.
- ⑦ **CLR button**
Cancels functions and clears entered numbers on a CD player or MD/CD recorder.
- ⑧ **MENU button**
Used to navigate menus on an HDD-compatible component.
- ⑨ **PLAYLIST [◀]/[▶] buttons**
Selects the previous or next playlist on an HDD-compatible component.
- ⑩ **RANDOM button**
Used with the random/shuffle playback function.
- ⑪ **REPEAT button**
Used with the repeat playback functions.
- ⑫ **PLAY MODE button**
Used to select play modes on components with selectable play modes.

Speakers

Subwoofer (SKW-540)

For detailed information, see the pages in parentheses.

■ Front

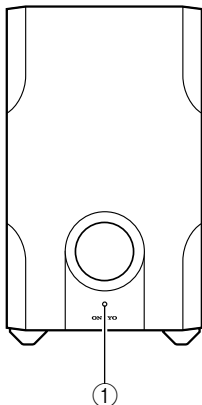

■ Rear

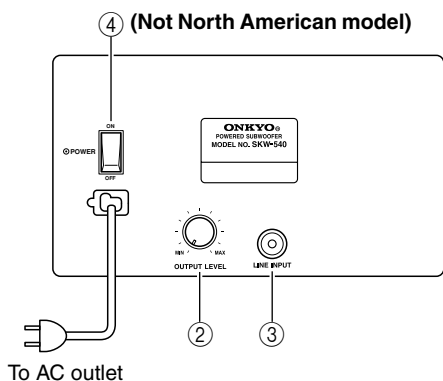

① **STANDBY/ON indicator**

Red: Subwoofer in standby mode
Green: Subwoofer on

With the Auto Standby function, the SKW-540 automatically turns on when an input signal is detected in Standby mode. When there's no input signal for a while, the SKW-540 automatically enters Standby mode.

② **OUTPUT LEVEL control (36)**

This control is used to adjust the volume of the subwoofer.

③ **LINE INPUT (19)**

This RCA input should be connected to the subwoofer pre out on the AV receiver with supplied RCA cable.

④ **POWER switch (Not North American model) (34)**

Press this switch to the ON position to turn on the power. Press it to the OFF position to turn off the power.

Note:

The Auto Standby function turns the subwoofer on when the input signal exceeds a certain level. If the Auto Standby function does not work reliably, try slightly increasing or decreasing the subwoofer output level on the AV receiver (page 53).

■ **Attaching and detaching the speaker grilles**

Front and Center speakers have detachable grilles. Use the following method to attach or detach the grilles.

1. While holding the bottom edge of the speaker grille with your both hands, pull it gently toward you to remove the bottom of the grille.
2. In the same way, gently pull the upper edge of the speaker grille toward you to remove it from the main unit.
3. To replace the grill, push the projections at the corners into the grille plug holes on the speaker cabinet.

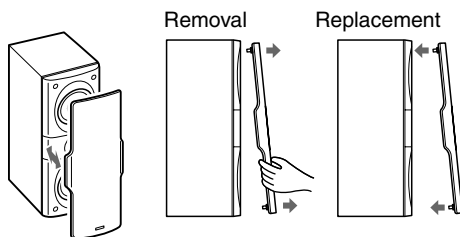

Connecting Your Speakers

Speaker Connection Precautions

Read the following before connecting your speakers:

- You can connect speakers with an impedance of **8 ohms or higher**. If you use speakers with a lower impedance, and use the amplifier at high volume levels for a long period of time, the built-in protection circuit may be activated.
- Disconnect the power cord from the wall outlet before making any connections.
- Pay close attention to speaker wiring polarity. In other words, connect positive (+) terminals to only positive (+) terminals, and negative (-) terminals to only negative (-) terminals. If you get them the wrong way around, the sound will be out of phase and will sound unnatural.
- Unnecessarily long, or very thin speaker cables may affect the sound quality and should be avoided.
- Be careful not to short the positive and negative wires. Doing so may damage the AV receiver.
- Don't connect more than one cable to each speaker terminal. Doing so may damage the AV receiver.
- Don't connect one speaker to several terminals.

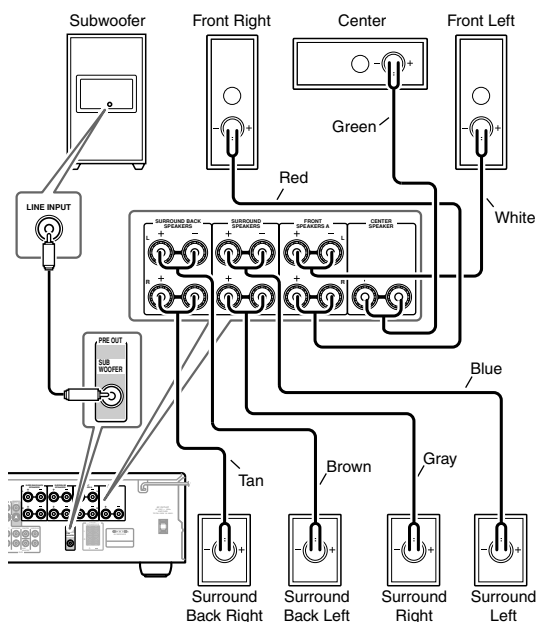
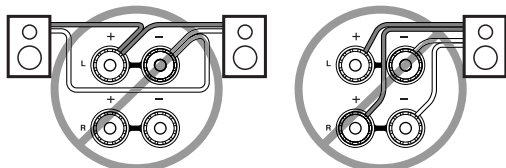
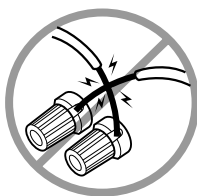

Connecting Speaker Set A

The AV receiver's positive (+) speaker terminals and speaker's positive (+) terminals are color-coded for ease of identification. (The negative (-) speaker terminals are all black.) Match the color of each cable to the corresponding speaker terminal.

Speaker terminal	Color
Front left	White
Front right	Red
Center	Green
Surround left	Blue
Surround right	Gray
Surround back left	Brown
Surround back right	Tan

- 1 On the AV receiver, unscrew the terminal. Fully insert the bare wires. Make sure that the bare wire is touching the inside of the pole. Screw the terminal tight.



- 2 On the speakers, while pressing the terminal lever, insert the wire into the hole, and then release the lever.

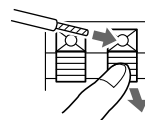

- 3 Using the supplied RCA cable, connect the AV receiver's SUBWOOFER PRE OUT to LINE INPUT on the subwoofer. Make sure the cable is plugged all the way.

Connecting Speaker Set B (sold separately)

- 1 Strip 3/8" (10 mm) of insulation from the ends of the speaker cables, and twist the bare wires tightly, as shown.

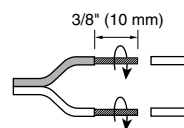

- 2 While pressing the lever, insert the wire into the hole, and then release the lever. Make sure that the terminals are gripping the bare wires, not the insulation.

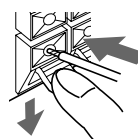

Note:

When speaker set B is turned on, speaker set A is reduced to 5.1-channel playback.

Connecting Antennas

This section explains how to connect the supplied indoor FM antenna and AM loop antenna, and how to connect commercially available outdoor FM and AM antennas. The AV receiver won't pick up any radio signals without any antenna connected, so you must connect the antenna to use the tuner.

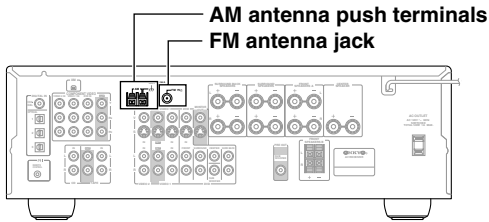

Connecting the Indoor FM Antenna

The supplied indoor FM antenna is for indoor use only.

1 Attach the FM antenna, as shown.

American Model

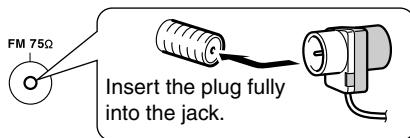

Other Models

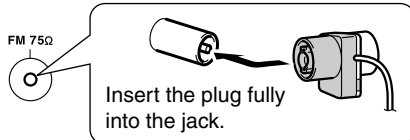

Once your AV receiver is ready for use, you'll need to tune into an FM radio station and adjust the position of the FM antenna to achieve the best possible reception.

2 Use thumbtacks or something similar to fix the FM antenna into position.

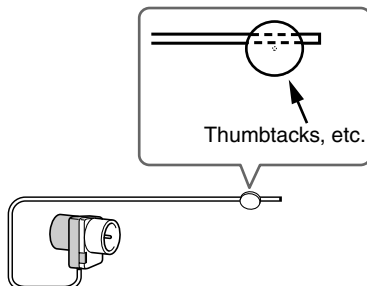

Caution: Be careful that you don't injure yourself when using thumbtacks.

If you cannot achieve good reception with the supplied indoor FM antenna, try a commercially available outdoor FM antenna instead (see page 21).

Connecting the AM Loop Antenna

The supplied indoor AM loop antenna is for indoor use only.

1 Assemble the AM loop antenna, inserting the tabs into the base, as shown.

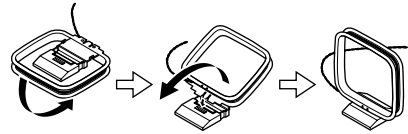

2 Connect both wires of the AM loop antenna to the AM push terminals, as shown.

(The antenna's wires are not polarity sensitive, so they can be connected either way around).

Make sure that the wires are attached securely and that the push terminals are gripping the bare wires, not the insulation.

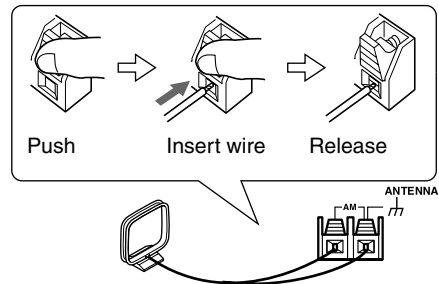

Once your AV receiver is ready for use, you'll need to tune into an AM radio station and adjust the position of the AM antenna to achieve the best possible reception.

Keep the antenna as far away as possible from your AV receiver, TV, speaker cables, and power cords.

If you cannot achieve good reception with the supplied indoor AM loop antenna, try using it with a commercially available outdoor AM antenna (see page 21).

Connecting Antennas—Continued

Connecting an Outdoor FM Antenna

If you cannot achieve good reception with the supplied indoor FM antenna, try a commercially available outdoor FM antenna instead.

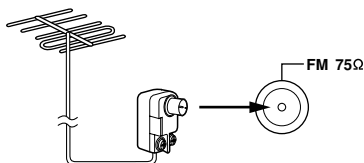

Notes:

- Outdoor FM antennas work best outside, but usable results can sometimes be obtained when installed in an attic or loft.
- For best results, install the outdoor FM antenna well away from tall buildings, preferably with a clear line of sight to your local FM transmitter.
- Outdoor antenna should be located away from possible noise sources, such as neon signs, busy roads, etc.
- For safety reasons, outdoor antenna should be situated well away from power lines and other high-voltage equipment.
- Outdoor antenna must be grounded in accordance with local regulations to prevent electrical shock hazards.

■ Using a TV/FM Antenna Splitter

It's best not to use the same antenna for both FM and TV reception, as this can cause interference problems. If circumstances demand it, use a TV/FM antenna splitter, as shown.

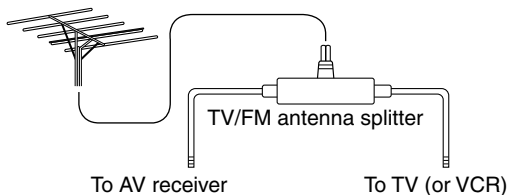

Connecting an Outdoor AM Antenna

If good reception cannot be achieved using the supplied AM loop antenna, an outdoor AM antenna can be used in addition to the loop antenna, as shown.

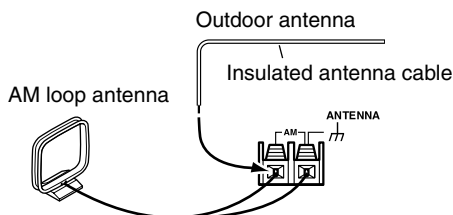

Outdoor AM antennas work best when installed horizontally outside, but good results can sometimes be obtained indoors by mounting horizontally above a window. Note that the AM loop antenna should be left connected. Outdoor antenna must be grounded in accordance with local regulations to prevent electrical shock hazards.

Connecting Your Components

About AV Connections

- Before making any AV connections, read the manuals supplied with your other AV components.
- Don't connect the power cord until you've completed and double-checked all AV connections.

Optical Digital Jacks

The AV receiver's optical digital jacks have shutter-type covers that open when an optical plug is inserted and close when it's removed. Push plugs in all the way.

Caution: To prevent shutter damage, hold the optical plug straight when inserting and removing.

AV Connection Color Coding

RCA-type AV connections are usually color coded: red, white, and yellow. Use red plugs to connect right-channel audio inputs and outputs (typically labeled "R"). Use white plugs to connect left-channel audio inputs and outputs (typically labeled "L"). And use yellow plugs to connect composite video inputs and outputs.

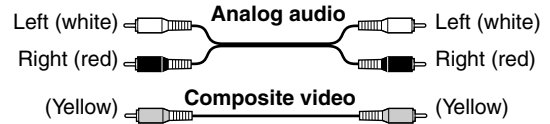

- Push plugs in all the way to make good connections (loose connections can cause noise or malfunctions).
- To prevent interference, keep audio and video cables away from power cords and speaker cables.

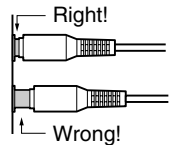

AV Cables and Jacks

Video

	Cable	Jack	Description
Component video cable			Component video separates the luminance (Y) and color difference signals (PR, PB), providing the best picture quality. (Some TV manufacturers label their component video jacks slightly differently.)
S-Video cable			S-Video separates the luminance and color signals and provides better picture quality than composite video.
Composite video cable			Composite video is commonly used on TVs, VCRs, and other video equipment. Use only dedicated composite video cables.

Audio

	Cable	Jack	Description
Optical digital audio cable			This offers the best sound quality and allows you to enjoy Dolby Digital and DTS. The audio quality is the same as for coaxial.
Coaxial digital audio cable			This offers the best sound quality and allows you to enjoy Dolby Digital and DTS. The audio quality is the same as for optical.
Analog audio cable (RCA)			This cable carries analog audio. It's the most common connection format for analog audio and can be found on virtually all AV components.
Multichannel analog audio cable (RCA)			This cable carries multichannel analog audio and is typically used to connect DVD players with a 7.1-channel analog audio output. Several standard analog audio cables can be used instead of a multichannel cable.

Connecting Audio and Video Signals to the AV Receiver

By connecting both the audio and video outputs of your DVD player and other AV components to the AV receiver, you can switch the audio and video signals simultaneously simply by changing the input source on the AV receiver.

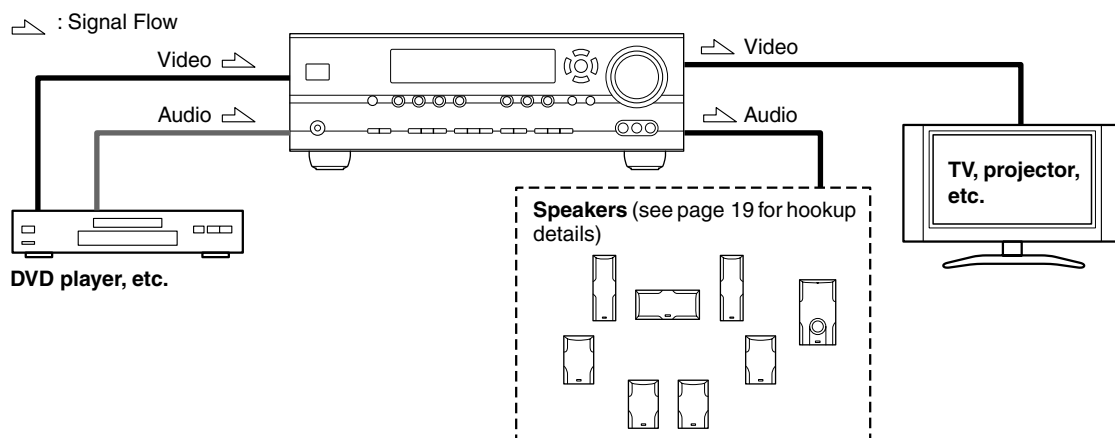

Which Connections Should I Use?

The AV receiver supports several connection formats for compatibility with a wide range of AV equipment. The format you choose will depend on the formats supported by your other components. Use the following sections as a guide. For video components, such as a DVD player, you must make an audio connection and a video connection.

Video Connection Formats

When choosing a connection format, bear in mind that the AV receiver doesn't convert between formats, so only outputs of the same format as the input will output the signal.

Video Signal Flow Chart

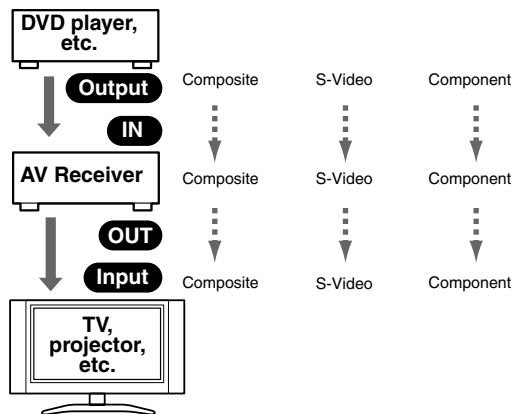

Audio Connection Formats

When choosing a connection format, bear in mind that the AV receiver doesn't convert between formats. For example, audio signals connected to an OPTICAL or COAXIAL digital input are not output by the analog TAPE OUT, so if you want to record from, for example, your CD player, in addition to connecting it to a digital input, you must also connect it to the analog CD IN.

Audio Signal Flow Chart

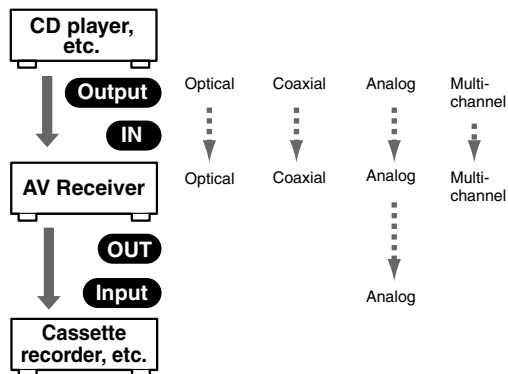

Connecting Your Components—Continued

Connecting a TV or Projector

Step 1: Video Connection

Choose a video connection that matches your TV (**A**, **B**, or **C**), and then make the connection.

Step 2: Audio Connection

Choose an audio connection that matches your TV (**a**, **b**, or **c**), and then make the connection.

- With connection **a**, you can listen to and record audio from your TV and listen via speaker set B.
- To enjoy Dolby Digital and DTS, use connection **b** or **c**. (For recording, use **a** and **b**, or **a** and **c**.)

Connection	AV receiver	Signal flow	TV	Picture quality
A	COMPONENT VIDEO OUT	⇒	Component video input	Best
B	MONITOR OUT S	⇒	S-Video input	Better
C	MONITOR OUT V	⇒	Composite video input	Standard
a	VIDEO 2 IN L/R	←	Analog audio L/R output	
b	DIGITAL IN COAXIAL	←	Digital coaxial output	
c	DIGITAL IN OPTICAL 2	←	Digital optical output	

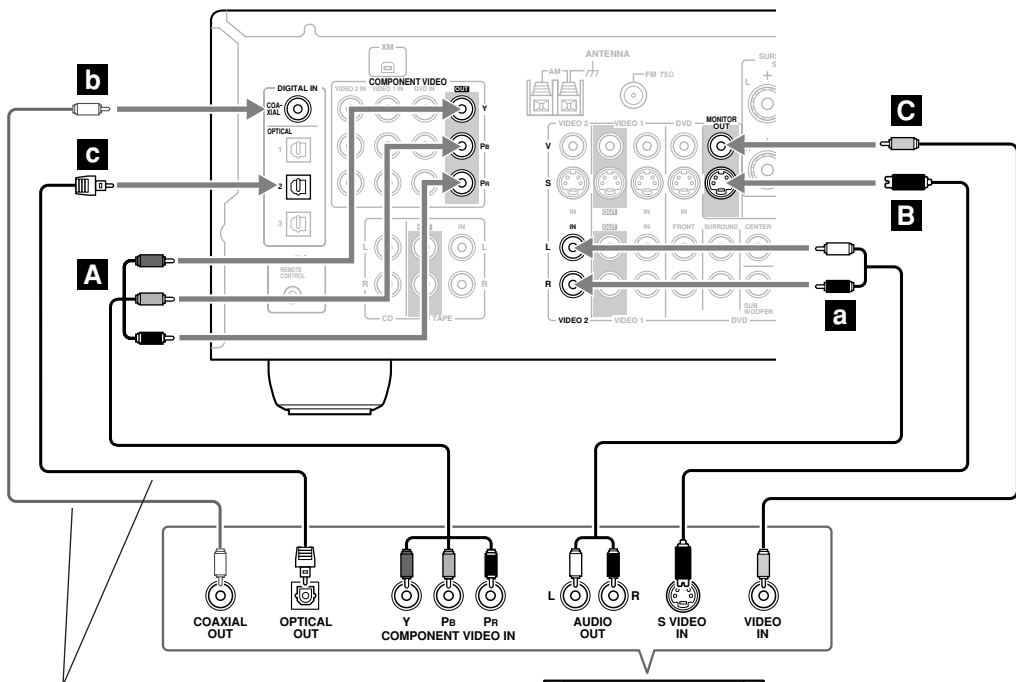

Connect one or the other
Connection **b** must be assigned (see page 35)

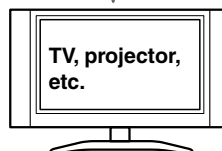

If your TV has no audio outputs, connect an audio output from your VCR or cable or satellite receiver to the AV receiver and use its tuner to listen to TV programs through the AV receiver (see pages 27 and 29).

Connecting Your Components—Continued

Connecting a DVD player

Step 1: Video Connection

Choose a video connection that matches your DVD player (**A**, **B**, or **C**), and then make the connection. You must connect the AV receiver to your TV via the same type of connection.

Step 2: Audio Connection

Choose an audio connection that matches your DVD player (**a**, **b**, or **c**), and then make the connection.

- With connection **a**, you can listen to and record audio from a DVD and listen via speaker set B.
- To enjoy Dolby Digital and DTS, use connection **b** or **c**. (For recording, use **a** and **b**, or **a** and **c**.)
- If your DVD player has main left and right outputs and multichannel left and right outputs, be sure to use the main left and right outputs for connection **a**.

Connection	AV receiver	Signal flow	DVD player	Picture quality
A	COMPONENT VIDEO DVD IN	←	Component video output	Best
B	DVD IN S	←	S-Video output	Better
C	DVD IN V	←	Composite video output	Standard
a	DVD IN FRONT	←	Analog audio L/R output	
b	DIGITAL IN COAXIAL	←	Digital coaxial output	
c	DIGITAL IN OPTICAL 1	←	Digital optical output	

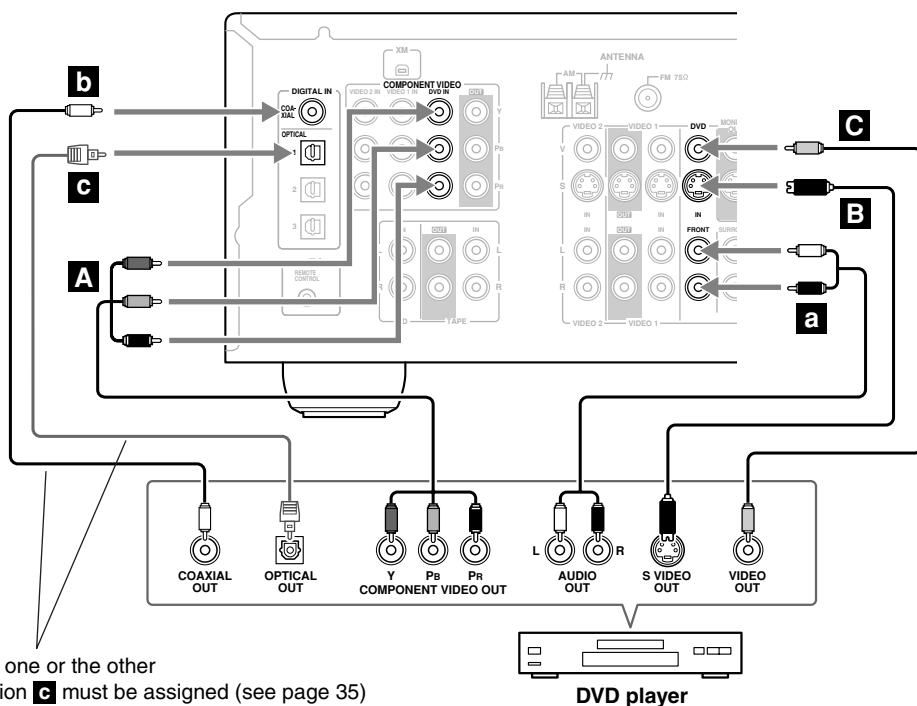

Connect one or the other
Connection **c** must be assigned (see page 35)

To connect a DVD player or DVD-Audio/SACD-capable player with a multichannel analog audio output, see page 26. ➔

Hooking Up the Multichannel DVD Input

If your DVD player supports multichannel audio formats such as DVD-Audio or SACD, and it has a multichannel analog audio output, you can connect it to the AV receiver's multichannel DVD input.

Use a multichannel analog audio cable, or several normal audio cables, to connect the AV receiver's DVD IN FRONT L/R, CENTER, SURROUND L/R, SURR BACK L/R, and SUBWOOFER jacks to the 7.1-channel analog audio output on your DVD player. If your DVD player has a 5.1-channel analog audio output, don't connect anything to the AV receiver's SURR BACK L/R jacks.

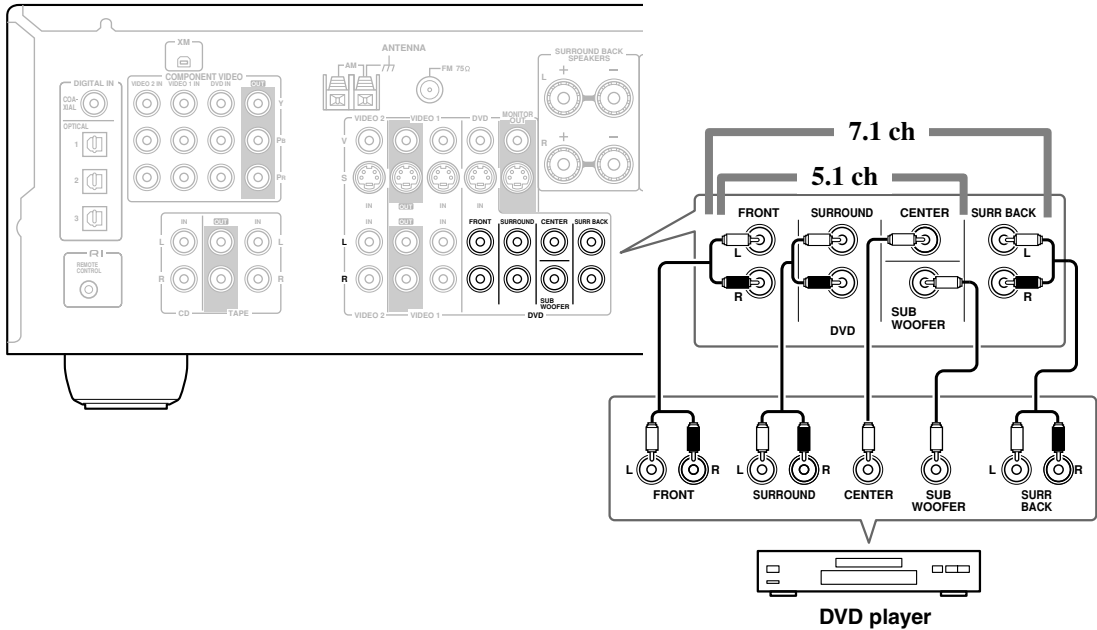

Connecting Your Components—Continued

Connecting a VCR or DVD Recorder for Playback



With this hookup, you can use your VCR's tuner to listen to your favorite TV programs via the AV receiver, useful if your TV has no audio outputs.

Step 1: Video Connection

Choose a video connection that matches your VCR or DVD recorder (**A**, **B**, or **C**), and then make the connection. You must connect the AV receiver to your TV via the same type of connection.

Step 2: Audio Connection

Choose an audio connection that matches your VCR or DVD recorder (**a**, **b**, or **c**), and then make the connection.

- With connection **a**, you can listen to the VCR or DVD recorder even via speaker set B.
- To enjoy Dolby Digital and DTS, use connection **b** or **c**. (To listen via speaker set B, use **a** and **b**, or **a** and **c**.)

Connection	AV receiver	Signal flow	VCR or DVD recorder	Picture quality
A	COMPONENT VIDEO VIDEO 1 IN	←	Component video output	Best
B	VIDEO 1 IN S	←	S-Video output	Better
C	VIDEO 1 IN V	←	Composite video output	Standard
a	VIDEO 1 IN L/R	←	Analog audio L/R output	
b	DIGITAL IN COAXIAL	←	Digital coaxial output	
c	DIGITAL IN OPTICAL 1	←	Digital optical output	

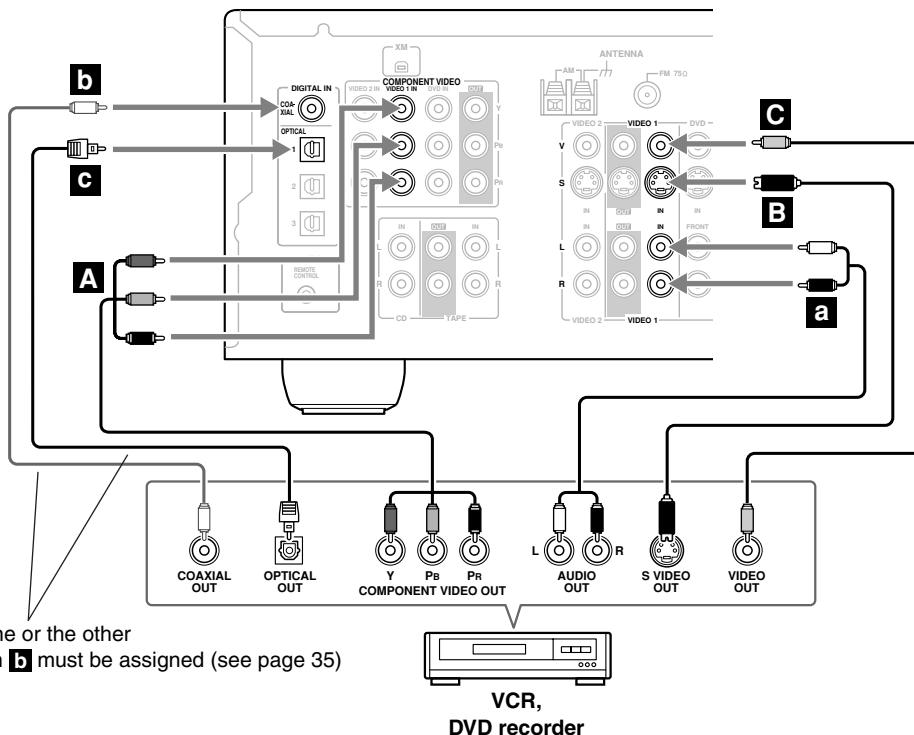

Connect one or the other
Connection **b** must be assigned (see page 35)

Connecting Your Components—Continued

Connecting a VCR or DVD Recorder for Recording

Step 1: Choose a video connection that matches your VCR or DVD recorder (**A** or **B**), and then make the connection. The video source to be recorded must be connected to the AV receiver via the same type of connection.

Step 2: Make the audio connection **a**.

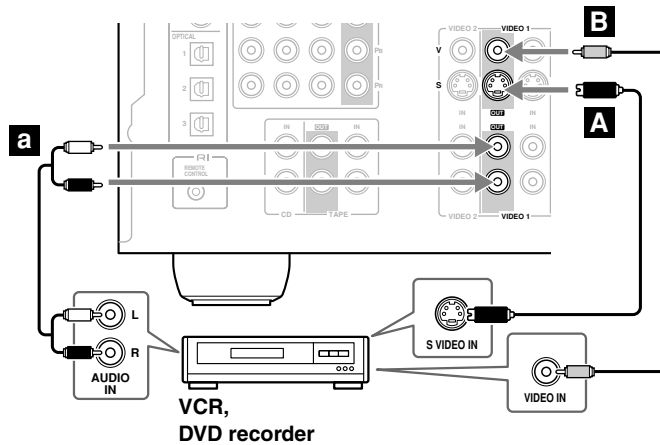

Connection	AV receiver	Signal flow	VCR or DVD recorder	Picture quality
A	VIDEO 1 OUT S	⇒	S-Video input	Better
B	VIDEO 1 OUT V	⇒	Composite video input	Standard
a	VIDEO 1 OUT L/R	⇒	Analog audio L/R input	—

Connecting a Camcorder, Games Console, or Other Device

Step 1: Make the video connection **A**.

Step 2: Make the audio connection **a**.

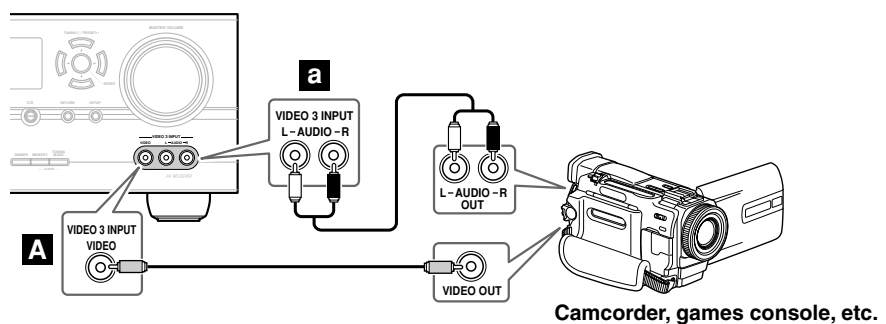

Connection	AV receiver	Signal flow	Camcorder or console
A	VIDEO 3 INPUT	←	Composite video output
a	VIDEO 3 INPUT L/R	←	Analog audio L/R output

Connecting Your Components—Continued

Connecting a Satellite, Cable, Set-top box, or Other Video Source



With this hookup, you can use your satellite or cable receiver to listen to your favorite TV programs via the AV receiver, useful if your TV has no audio outputs.

Step 1: Video Connection

Choose a video connection that matches the video source (**A**, **B**, or **C**), and then make the connection. You must connect the AV receiver to your TV via the same type of connection.

Step 2: Audio Connection

Choose an audio connection that matches the video source (**a**, **b**, or **c**), and then make the connection.

- With connection **a**, you can listen to and record audio from the video source and listen via speaker set B.
- To enjoy Dolby Digital and DTS, use connection **b** or **c**. (For recording, use **a** and **b**, or **a** and **c**.)

Connection	AV receiver	Signal flow	Video source	Picture quality
A	COMPONENT VIDEO VIDEO 2 IN	←	Component video output	Best
B	VIDEO 2 IN S	←	S-Video output	Better
C	VIDEO 2 IN V	←	Composite video output	Standard
a	VIDEO 2 IN L/R	←	Analog audio L/R output	
b	DIGITAL IN COAXIAL	←	Digital coaxial output	
c	DIGITAL IN OPTICAL 2	←	Digital optical output	

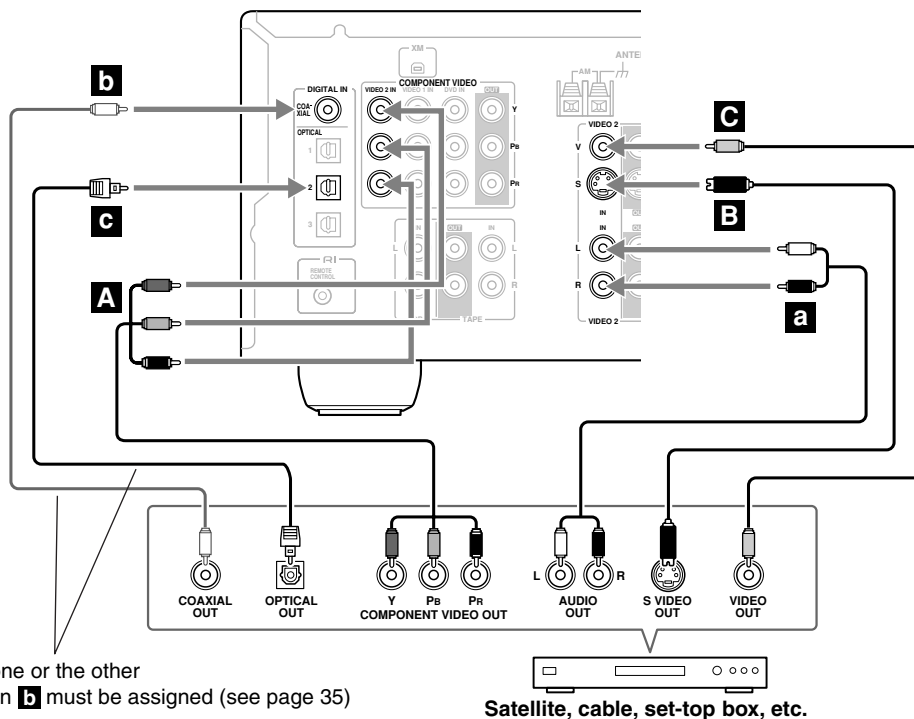

Connecting a CD Player or Turntable

■ CD Player or Turntable (MM) with Built-in Phono Preamp

Step 1:

Choose a connection that matches your CD player (**a**, **b**, or **c**). Use connection **a** for a turntable with a built-in phono preamp.

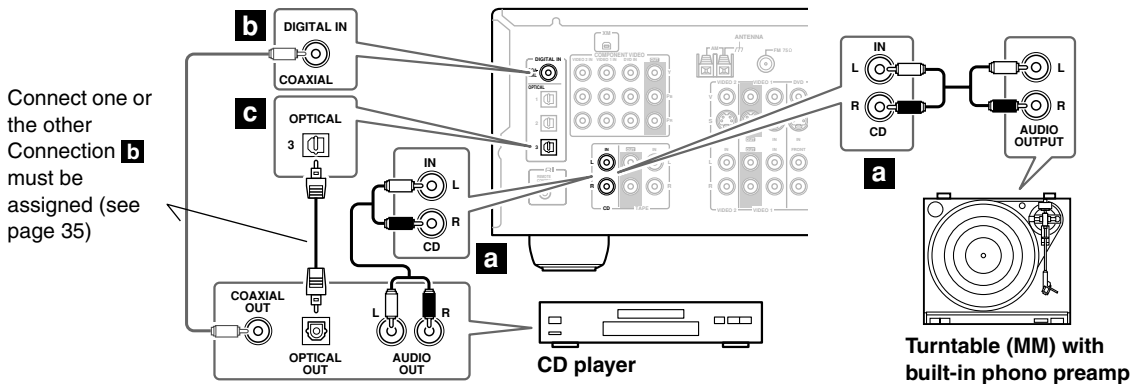

- With connection **a**, you can listen to and record audio from your CD player or turntable and listen via speaker set B.
- To connect the CD player digitally, use connection **b** or **c**. (For recording, use **a** and **b**, or **a** and **c**.)

Connection	AV receiver	Signal flow	CD or turntable
a	CD IN L/R	←	Analog audio L/R output
b	DIGITAL IN COAXIAL	←	Digital coaxial output
c	DIGITAL IN OPTICAL 3	←	Digital optical output

■ Turntable (MM) with no Phono Preamp Built-in

A phono preamp is necessary to connect a turntable that doesn't have a phono preamp built-in.

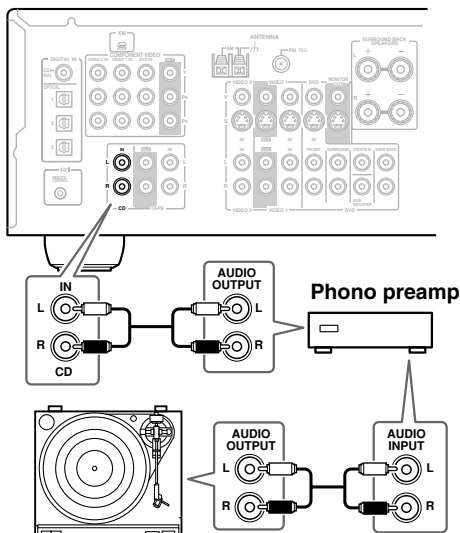

■ Turntable with an MC (Moving Coil) Cartridge

An MC head amp and phono preamp are necessary to connect a turntable with an MC (Moving Coil) cartridge.

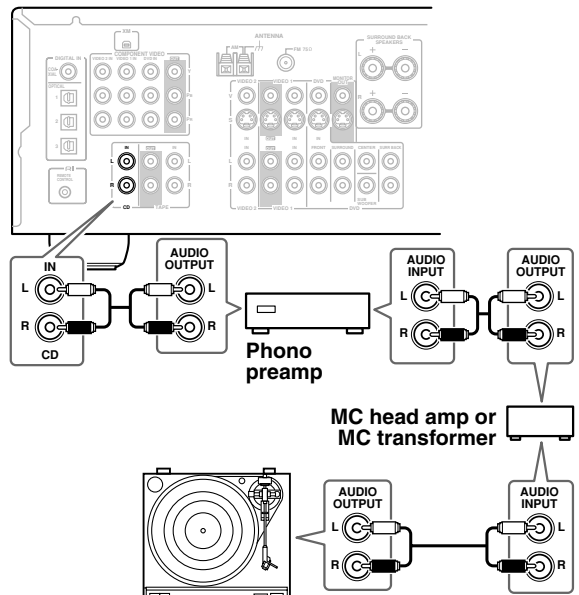

Connecting an HDD-compatible Component

As of this printing, the Onkyo Remote Interactive Dock is the only HDD-compatible component available.

■ For HDD-compatible components that support video

Connect your HDD-compatible component's analog audio output jacks and S-Video output jack to the AV receiver's VIDEO 2 IN L/R jacks and VIDEO 2 IN S jack.

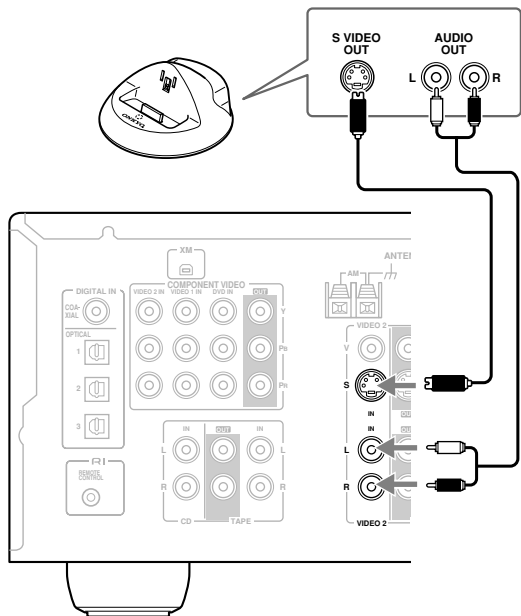

■ For HDD-compatible components that don't support video

Connect your HDD-compatible component's analog audio output jacks to the AV receiver's TAPE IN L/R jacks.

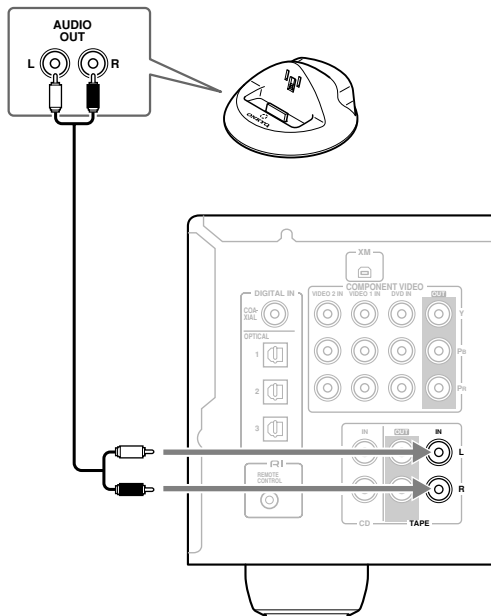

Notes:

- Connect the Remote Interactive Dock with an **RI** cable (see page 33).
- Set the Remote Interactive Dock's RI MODE switch to HDD.
- Set the AV receiver's Input Display to HDD (see page 35).
- Refer to the Remote Interactive Dock's instruction manual.

Connecting Your Components—Continued

Connecting a Cassette, CDR, MiniDisc, or DAT Recorder

Step 1:

Choose a connection that matches the recorder (**a**, **b**, or **c**), and then make the connection.

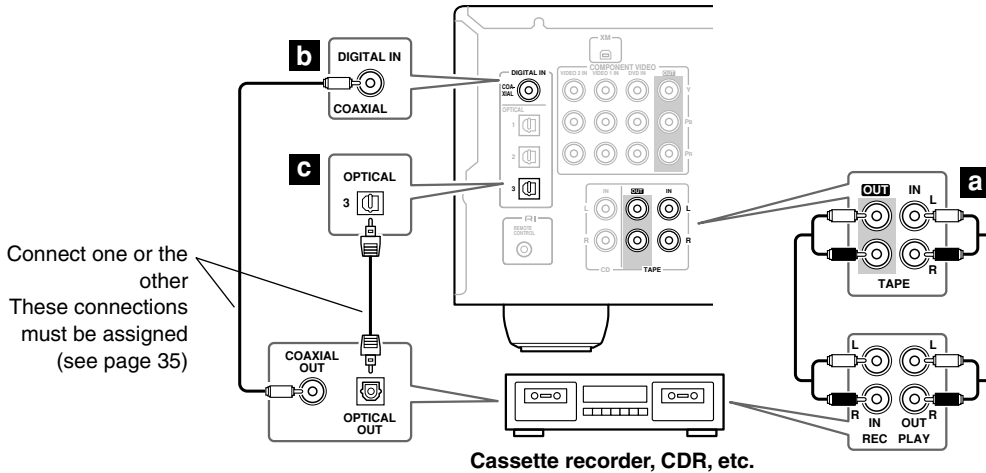

- With connection **a**, you can listen via speaker set B.
- To connect the recorder digitally, use connections **a** and **b**, or **a** and **c**.

Connection	AV receiver	Signal flow	Cassette/CDR/MD/DAT recorder
a	TAPE IN L/R TAPE OUT L/R	← ⇒	Analog audio L/R output Analog audio L/R input
b	DIGITAL IN COAXIAL	←	Digital coaxial output
c	DIGITAL IN OPTICAL 3	←	Digital optical output

Connecting the Power Cord of Another Component

The AV receiver has an AC outlet on its rear panel for connecting the power cord of another AV component. The other component's power switch can then be left in the ON position so that it turns on or off when the AV receiver is set to On or Standby.

Caution:

- Make sure that the capacity of the component that you connect to the AC OUTLET does not exceed the stated capacity (e.g., 100 W).

Notes:

- Onkyo components connected via **R1** should be connected directly to a wall outlet, not the AV receiver's AC OUTLET.
- The socket type and capacity depends on the country in which you purchased the AV receiver.

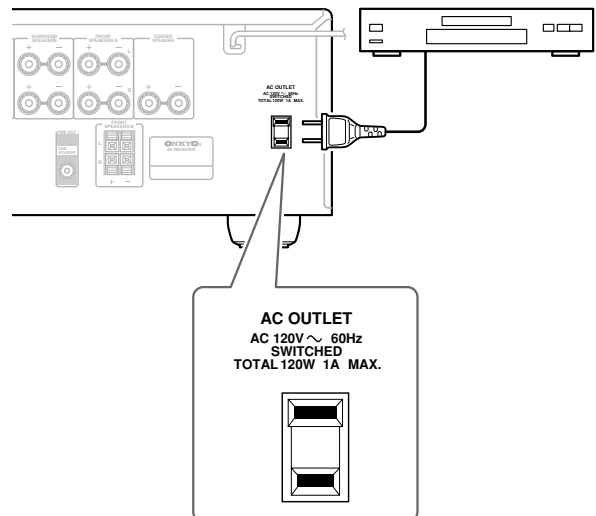

Connecting Onkyo **RI** Components

Step 1: Make sure that each Onkyo component is connected to the AV receiver with an analog audio cable (connection **a** in the hookup examples) (see pages 24 to 32).

Step 2: Make the **RI** connection.

Step 3: If you're using an MD, CDR, or HDD component, change the input Display (see page 35).

With **RI** (Remote Interactive), you can use the following special functions:

■ Auto Power On/Standby

When you start playback on a component connected via **RI**, if the AV receiver is on Standby, it will automatically turn on and select that component as the input source. Similarly, when the AV receiver is set to Standby, all components connected via **RI** will also go on Standby. This function will not work on components connected to an AC OUTLET on the AV receiver.

■ Direct Change

When playback is started on a component connected via **RI**, the AV receiver automatically selects that component as the input source. If your DVD player is connected to the AV receiver's multichannel DVD input, you'll need to press the [MULTI CH] button to hear all channels (see page 37), as the Direct Change **RI** function only selects the FRONT DVD IN jacks.

■ Remote Control

You can use the AV receiver's remote controller to control your other **RI**-capable Onkyo components, pointing the remote controller at the AV receiver's remote control sensor instead of the component. You must enter the appropriate remote control code first (page 59).

Notes:

- Use only **RI** cables for **RI** connections. **RI** cables are supplied with Onkyo players (DVD, CD, etc.).
- Some components have two **RI** jacks. You can connect either one to the AV receiver. The other jack is for connecting additional **RI**-capable components.
- Connect only Onkyo components to **RI** jacks. Connecting other manufacturer's components may cause a malfunction.
- Some components may not support all **RI** functions. Refer to the manuals supplied with your other Onkyo components.

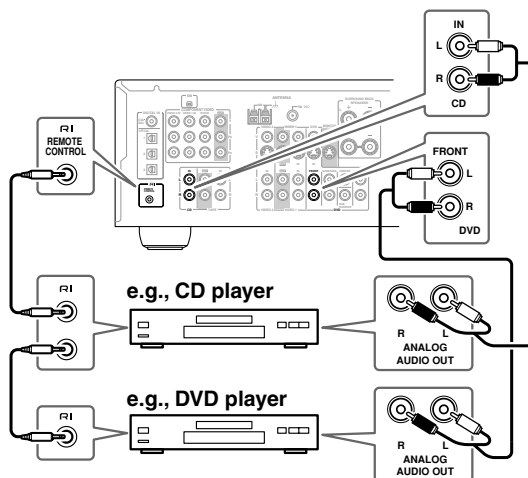

Connecting the Power Cord

- Connect the AV receiver's and subwoofer's power cord to a suitable wall outlet.

Notes:

- **Before connecting the power cord, connect all of your speakers and AV components.**
- Turning on the AV receiver and subwoofer may cause a momentary power surge that might interfere with other electrical equipment on the same circuit. If this is a problem, plug the AV receiver into a different branch circuit.

Turning On the AV Receiver

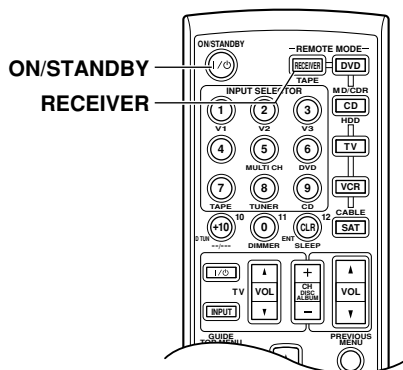
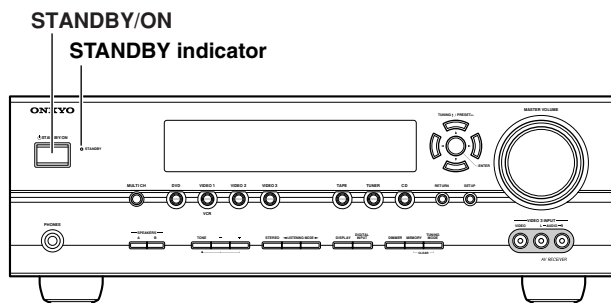

Turning On and Standby

1

AV receiver

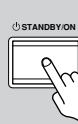

or

Remote controller



Press the [STANDBY/ON] button.

Alternatively, press the remote controller's [RECEIVER] button, followed by the [ON/STANDBY] button.

The AV receiver comes on, the display lights up, and the STANDBY indicator goes off.

To turn the AV receiver off, press the [STANDBY/ON] button, or press the remote controller's [ON/STANDBY] button. The AV receiver will enter Standby mode. To prevent any loud surprises when you next turn on the AV receiver, always turn down the volume before you turn it off.

To turn on the subwoofer, press its [POWER] switch to the ON position (not North American models).

Smooth Operation in a Few Easy Steps

To ensure smooth operation, here's a few easy steps to help you configure the AV receiver before you use it for the very first time. These settings only need to be made once.

■ Have you connected a component to a digital audio input?

If you have, see "Assigning Digital Inputs to Input Sources" on page 35.

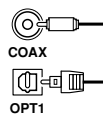

■ Have you connected an Onkyo MD recorder, CD recorder, or next generation HDD-compatible component?

If you have, see "Changing the Input Display" on page 35.



Testing the speakers

To test that all of the speakers are working properly, **press the remote controller's [TEST TONE] button**. The test tone will be output by each speaker in turn and the name of each speaker will appear on the display. To turn off the test tone, press the [TEST TONE] button again.

- If the test tone is not produced by a speaker, or it's produced by a speaker other than that shown on the display, you may have wired the speakers incorrectly and you should check your connections (see page 19).
- Testing cannot be performed while speaker set B is on or a pair of headphones is connected.

First Time Setup

Assigning Digital Inputs to Input Sources

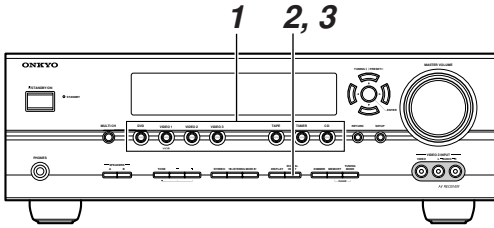

To enjoy Dolby Digital and DTS, you must connect your DVD player to the AV receiver digitally (coaxial or optical).

Here are the default assignments.

Input selector	Default assignment
DVD	COAX
VIDEO 1	OPT 1
VIDEO 2	OPT 2
VIDEO 3	----
TAPE	----
CD	OPT 3

With this function, you can change the digital inputs assign. If, for example, you connect your DVD player to the DIGITAL IN OPTICAL 1 input (OPT1), you'll need to assign it to the DVD input source, as follows.

1

Press the input selector button for the input source that you want to assign.
(Digital inputs cannot be assigned to the TUNER input source.)

2

Press the [DIGITAL INPUT] button.
The current assignment appears.

DVD # COAX

3

Press the [DIGITAL INPUT] button repeatedly to select COAX, OPT1, OPT2, OPT3, or "----" (analog).

DVD # OPT1

Note:

Make sure that components connected digitally are configured to output digital audio. Refer to the relevant manuals.

Changing the Input Display

If you connect an **RI**-capable Onkyo MiniDisc recorder, CD recorder or next generation HDD-compatible component to the TAPE IN/OUT or VIDEO 2 IN jacks, for **RI** to work properly, you must change this setting.

This setting can only be changed on the AV receiver.

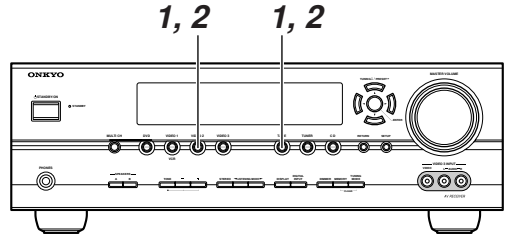

1

Press the [TAPE] or [VIDEO 2] input selector button so that "TAPE" or "VIDEO2" appears on the display.

TAPE

VIDEO2

2

Press and hold down the [TAPE] or [VIDEO 2] input selector button (about 3 seconds) to change the setting.
Repeat this step to select MD, CDR, or HDD.
For the TAPE input selector, the setting changes in this order:
TAPE → MD → CDR → HDD
For the VIDEO 2 input selector, the setting changes in this order:
VIDEO 2 ↔ HDD

Note:

HDD can be selected for the TAPE input selector or VIDEO 2 input selector, but not both at the same time.

Playing Your AV Components

Basic AV Receiver Operation

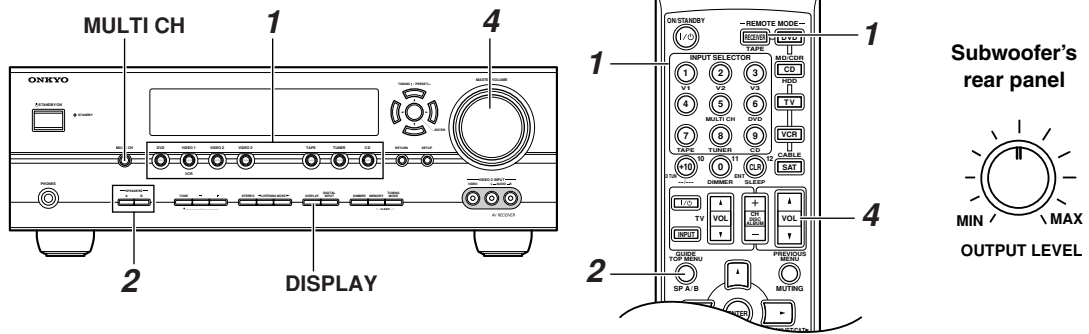

- 1**

Remote controller

AV receiver

Use the AV receiver's input selector buttons to select the input source.

To select the input source with the remote controller, press the [RECEIVER] REMOTE MODE button, and then use the INPUT SELECTOR buttons.

On the remote controller, the [V1], [V2], and [V3] buttons select the VIDEO 1, VIDEO 2, and VIDEO 3 input sources respectively.
- 2**

Remote controller

AV receiver

To turn the speakers on or off, use the AV receiver's SPEAKERS [A] and [B] buttons, or use the remote controller's [SP A/B] button.

Pressing the remote controller's [SP A/B] button cycles through the following settings: Speaker Set A → Speaker Set A&B → Speaker Set B → Off.

Note that while speaker set B is on, speaker set A is reduced to 5.1-channel playback.

See page 5 for more information about speaker sets A and B.
- 3**

Start playback on the source component.

To watch a DVD or other video source, on your TV, select the video input that's connected to the AV receiver's MONITOR OUT jack.
- 4**

Remote controller

AV receiver

To adjust the volume, use the MASTER VOLUME control, or the remote controller's [VOL] button.

The volume can be set to MIN, 1 through 79, or MAX. Since the AV receiver is designed for home theater enjoyment, it has a wide volume range for precise adjustment.

To set the level of the subwoofer, use the OUTPUT LEVEL control.

Because our ears are less sensitive to very low bass sounds, there's a temptation to set the level of the subwoofer too high. As a rule of thumb, set the subwoofer level to what you think is the optimal level, and then back it off slightly.
- 5**

Select a suitable listening mode and enjoy!

See "Using the Listening Modes" on page 46.

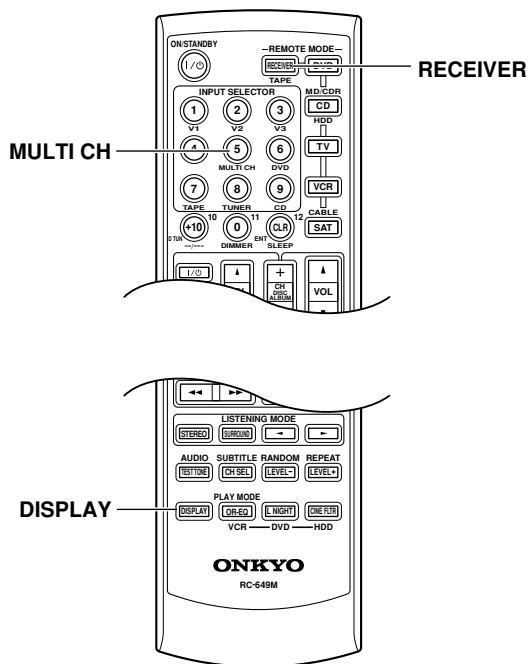

Using the Multichannel DVD Input

The multichannel DVD input is for connecting a component with a 7.1-channel analog audio output, such as a DVD-Audio or SACD-capable DVD player, or an MPEG decoder. See page 26 for hookup information.

Press the [RECEIVER] REMOTE MODE button, followed by the [MULTI CH] button.

The MULTI CH indicator appears on the display.

MULTI CH indicator

MULTI CH

DVD

Audio from the multichannel DVD input will now be used for the DVD input source.

Note:

- While the multichannel DVD input is selected, the Speaker Configuration settings on page 54 are ignored, and signals from the multichannel input are fed to the speakers as they are.

Displaying Source Information

You can display various information about the current input source as follows.

Press the [RECEIVER] REMOTE MODE button, and then press the [DISPLAY] button repeatedly to cycle through the available information.

The following information can typically be displayed:

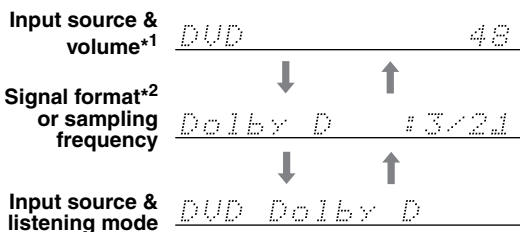

- *1 When AM or FM radio is used, the band, preset number, and frequency are displayed.
- *2 If the input signal is analog, or AM or FM radio is selected, no format information is displayed. If the input signal is PCM, the sampling frequency is displayed. If the input signal is digital but not PCM, the signal format is displayed. Information is displayed for about 3 seconds, then the previous display reappears.

Note:

- The listening mode is displayed only when speaker set A is on.

Interpreting Surround Channel Information

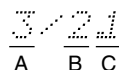

- A: The number of front channels (front left, front right, and center).
- B: The number of surround channels (surround left and surround right). If there's surround back channel information, this number will be 3.
- C: LFE channel for subwoofer (1 means yes).

Listening to the Radio

Listening to AM/FM stations

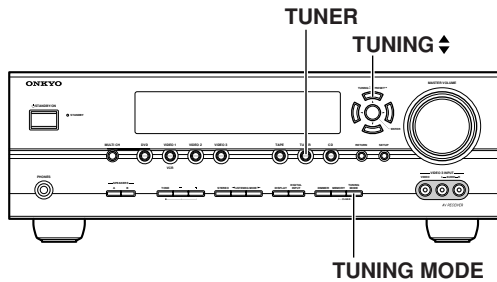

With the built-in tuner, you can enjoy AM and FM radio stations.

1  **Use the [TUNER] input selector button to select AM or FM.**
In this example, FM has been selected.

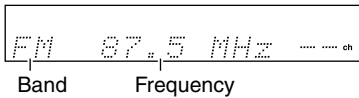



(Actual display depends on country.)

■ **AM Frequency Step Setup (not North America)**
You must specify the AM frequency step used in your area. Note that when this setting is changed, all radio presets are deleted.



- 1** Press the [SETUP] button, use the Up and Down [▲]/[▼] buttons to select “0. Hardware Setup,” and then press [ENTER].
- 2** Use the Up and Down [▲]/[▼] buttons to select “AM Freq,” and then use the Left and Right [◀]/[▶] buttons to select:
 - 10 kHz:** Select if 10 kHz steps are used in your area.
 - 9 kHz:** Select if 9 kHz steps are used in your area.
- 3** Press the [SETUP] button. Setup closes.

Tuning into AM/FM Radio Stations

■ Auto Tuning Mode

- 1**  **Press the [TUNING MODE] button so that the AUTO indicator appears on the display.**
- 2**  **Press the TUNING Up or Down [▲]/[▼] button.**
Searching stops when a station is found.

■ Manual Tuning Mode

- 1**  **Press the [TUNING MODE] button so that the AUTO indicator disappears from the display.**
- 2**  **Press and hold the TUNING Up or Down [▲]/[▼] button.**
The frequency stops changing when you release the button.
Press the buttons repeatedly to change the frequency one step at a time.

The American model changes FM frequency in 0.2 MHz steps, 10 kHz steps for AM. For other models it's 0.05 MHz steps for FM and 9 kHz (or 10 kHz) steps for AM.

When tuned into a station, the TUNED indicator appears. When tuned into a stereo FM station, the FM STEREO indicator also appears.

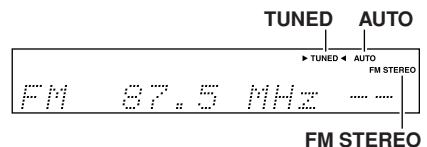

Tuning into Weak FM Stereo Stations

If the signal from a stereo FM station is weak, it may be impossible to get good reception. In this case, switch to Manual Tuning mode and listen to the station in mono.

Note:

- You can also use the remote controller's Up and Down [▲]/[▼] buttons to tune the radio.

Listening to the Radio—Continued

■ Tuning into Stations by Frequency

You can tune into AM and FM stations directly by entering the appropriate frequency.

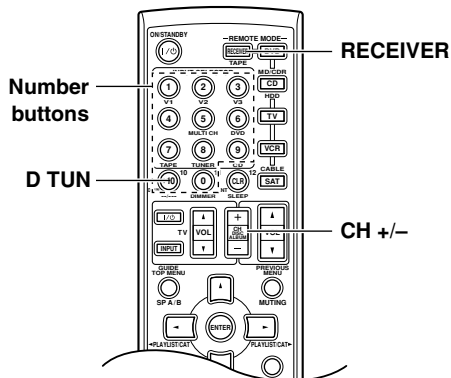

1 Press the [RECEIVER] button, followed by the [D TUN] button.

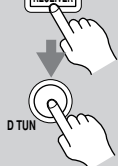

(Actual display depends on country.)
The [RECEIVER] button flashes.

2 Within 8 seconds, use the number buttons to enter the frequency of the radio station.
For example, to tune to 87.5 (FM), press 8, 7, 5.
Note: While the [RECEIVER] button is flashing, the input source cannot be changed by using the remote controller.

2 Press the [MEMORY] button.
The MEMORY indicator appears and the preset number flashes.

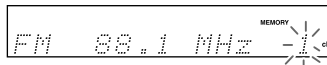
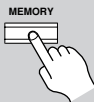

3 While the MEMORY indicator is displayed (about 8 seconds), use the PRESET [◀]/[▶] buttons to select a preset from 1 through 40.



4 Press the [MEMORY] button again to store the station or channel.
The station or channel is stored and the preset number stops flashing.
Repeat this procedure for all of your favorite AM/FM radio stations and XM channels.

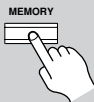

■ Selecting Presets

1 To select a preset, use the PRESET [◀]/[▶] buttons, or the remote controller's CH [+/-] button.



Presetting AM/FM Stations and XM Channels

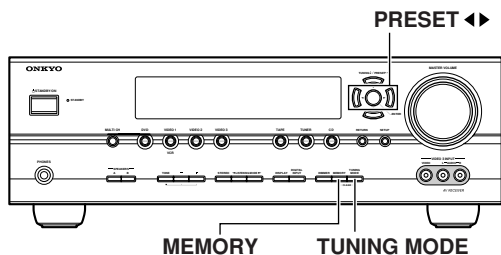

You can store a combination of up to 40 of your favorite AM/FM radio stations and XM channels as presets.

1 Tune into the AM/FM station or XM channel that you want to store as a preset.
See page 40 to select XM channels.

■ Deleting Presets

1 Select the preset that you want to delete.
See the previous section.

2 While holding down the [MEMORY] button, press the [TUNING MODE] button.
The preset is deleted and its number disappears from the display.

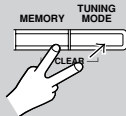

Listening to XM Satellite Radio® (North American Models Only)

Important XM Radio Information

To receive XM Radio on this receiver you need to purchase an optional XM Passport System and subscribe to XM's paid programming. Please note that XM is currently only licensed to provide service to the contiguous 48 United States (not available in Alaska and Hawaii) and portions of Canada. XM Radio service is not currently available in Mexico or any other region outside the continental U.S. and portions of Canada. For updates on service availability please visit XM's website at <http://www.xmradio.com> or <http://www.xmradio.ca>

Note:

Hardware and required basic monthly subscription sold separately. Premium Channels available at additional monthly cost. Installation costs and other fees and taxes, including a one-time activation fee may apply. Subscription fee is consumer only. All fees and programming subject to change.

About XM Radio:

There is a world beyond AM and FM. It is XM Satellite Radio. XM offers more than 160 digital channels of audio entertainment, including 100% commercial-free music channels, in the top markets in the U.S. Channels with frequent explicit language are indicated with an XL. Channel blocking is available for XM radio receivers by calling 1-800-XMRADIO.

About XM Canada:

XM Canada offers the most commercial-free music – and engaging talk show programs. XM Canada creates original content that reflects our unique Canadian culture and broadcasts it throughout North America.

Canadian Satellite Radio Inc. offers its satellite radio service and operates under the XM Canada™ brand. XM Canada has an exclusive Canadian licence from XM Satellite Radio Inc.

For more information about XM Canada, visit www.xmradio.ca or call 1-877-GET-XMSR

A warning against reverse engineering:

It is prohibited to copy, decompile, disassemble, reverse engineer, or manipulate any technology incorporated in receivers compatible with the XM Satellite Radio system. Furthermore, the AMBE® voice compression software included in this product is protected by intellectual property rights including patent rights, copyrights, and trade secrets of Digital Voice Systems, Inc. The user of this or any other software contained in an XM Radio is explicitly prohibited from attempting to copy, decompile, reverse engineer, or disassemble the object code, or in any other way convert the object code into human-readable form. The software is licensed solely for use within this product.

Connecting the XM Passport System

The XM Passport System is sold separately. You can purchase the *XM Passport System* from the XM Web site at: <http://www.xmradio.com> (U.S.A.)
<http://www.xmradio.ca> (Canada)

Connect the Passport System to the XM antenna jack on the rear panel.

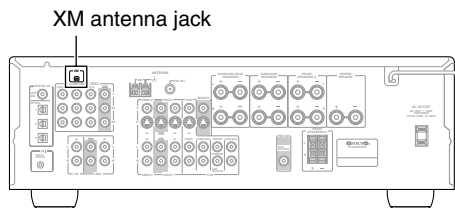

Put the XM Passport System by a southerly facing window, with nothing obstructing its path to the sky.

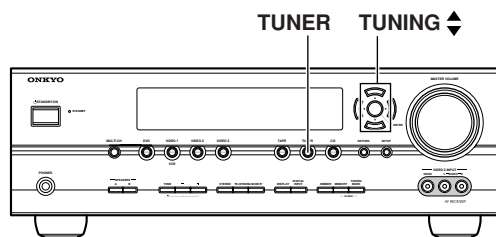

Selecting XM Satellite Radio

1



Press the [TUNER] input selector button repeatedly to select XM.

If "CHECK ANTENNA" appears on the display, make sure the XM Passport System is connected properly.

Listening to the Radio—Continued

Signing Up for XM Satellite Radio

Before you can use XM Satellite Radio, you must first sign up for an account. You'll need a major credit card and your *XM Satellite Radio ID*, which you can get from the AV receiver, as explained below, or from the Passport System package and itself.

1	<p>Use the TUNING Up and Down [▲]/[▼] buttons to select channel 0.</p> <p>Your XM Satellite Radio ID number is displayed. Write it below.</p> <p style="text-align: center;">ID _____</p>
2	<p>To sign up, go to: http://activate.xmradio.com Or call: 1-800-967-2346</p> <p>For XM Canada, go to: http://xmradio.ca Or call: 1-877-GET-XMSR</p>

Notes:

- Channel 0 cannot be selected in Category Search mode. You must select Channel Search mode (see page 41).
- The following letters are not used in XM Satellite Radio IDs: I, O, S, F.

Selecting XM Radio Channels

There are three ways to select XM radio channels:

- **Channel Search mode:** select any channel.
- **Category Search mode:** select channels by category.
- **Direct tuning:** enter channel number.

Note:

You can't select Channel Search or Category Search mode, while the Tuning Arrow ► ◀ indicators are flashing, as tuning is in progress.

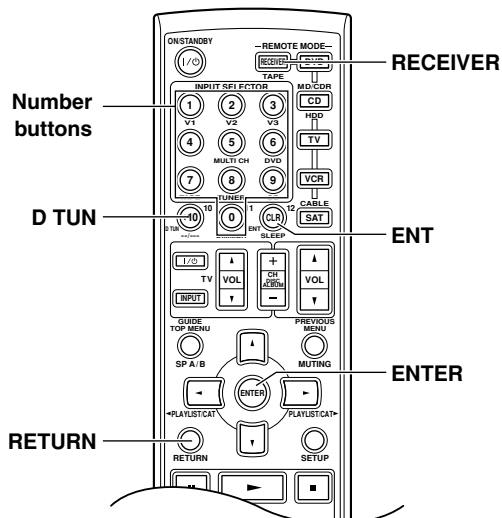

Channel Search Mode

1	<p>Press the [RECEIVER] button, followed by the [ENTER] button to select "Channel Search" mode.</p> <p style="text-align: center;">ChannelSearch</p>
2	<p>Use the Up and Down [▲]/[▼] buttons to select a channel.</p> <p style="text-align: center;">050 The Loft</p> <p style="text-align: center;">Channel number Channel name</p> <p>You can also use the Left and Right [◀]/[▶] buttons to select a category.</p>

Category Search Mode

1	<p>Press the [RECEIVER] button, followed by the [ENTER] button to select "Category Search" mode.</p> <p style="text-align: center;">CategorySearch</p>
2	<p>Use the Left and Right [◀]/[▶] buttons to select a category, and use the Up and Down [▲]/[▼] buttons to select a channel in that category.</p>

Direct Tuning

You can select an XM radio channel directly by entering its number.

1	<p>Press the [RECEIVER] button, followed by the [D TUN] button. The [RECEIVER] button flashes.</p> <p style="text-align: center;">XM</p>
2	<p>Within 8 seconds, use the number buttons to enter the channel number.</p> <p>The channel is selected.</p> <p>For example, to select channel #20, press 0, 2, 0, or 2, 0, [ENT].</p> <p>Note: While the [RECEIVER] button is flashing, the input source cannot be changed by using the remote controller.</p>

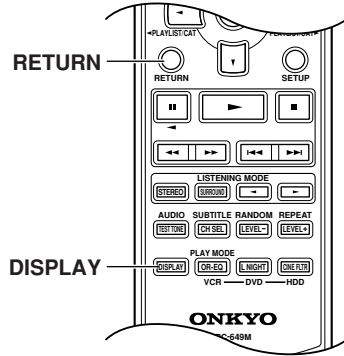
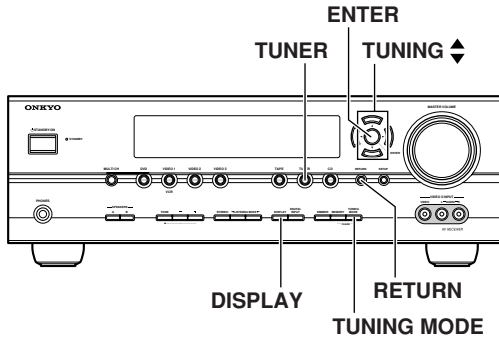

Selecting XM Channels from the Front Panel:

<p>1</p>	<p>Press the [TUNING MODE] button to select “Channel Search” or “Category Search” mode.</p>
<p>2</p>	<p>Press the [ENTER] button repeatedly to select a category.</p>
<p>3</p>	<p>Use the TUNING Up and Down [▲]/[▼] buttons to select a channel.</p> <p>In Channel Search mode, you can select any channel.</p> <p>In Category Search mode, you can only select channels from the currently selected category.</p>

Selecting the Previous Channel:

<p>1</p> <p>AV receiver RETURN</p> <p>Remote controller RETURN</p>	<p>To listen to the previously selected XM channel, press the [RETURN] button.</p>
---	--

Displaying XM Radio Information

<p>1</p> <p>AV receiver DISPLAY</p> <p>Remote controller DISPLAY</p>	<p>Press the [DISPLAY] button repeatedly to cycle through the available information.</p>
---	--

The following information can be displayed:

Channel name	XM The Loft
Channel number & preset number	XM 050 5
Category	CAT >Rock
Artist	NAME>Coldplay
Song title	TITL>Clocks
Listening mode	XM Stereo

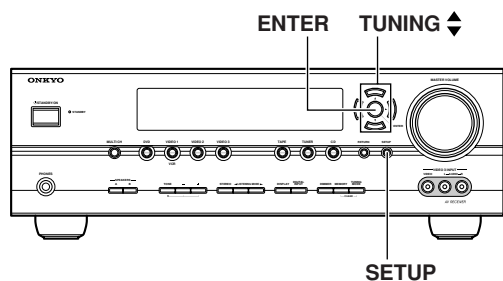

Notes:

- If the category, artist, or song title is not available, “- -” will be displayed instead.
- The listening mode is displayed only when speaker set A is on.



Positioning the XM Passport System

You can check the signal strength of the XM radio signal and adjust the position of the XM Passport System accordingly.

1 	<p>On the AV receiver, press the [SETUP] button.</p>
2 	<p>Use the Up and Down [▲]/[▼] buttons to select “5. ANT Aiming,” and then press [ENTER].</p> <div style="border: 1px solid black; padding: 5px; text-align: center; margin-top: 10px;"> 5. ANT Aiming </div>
3	<p>Adjust the position of the XM Passport System so that the SAT signal strength bar is as long as possible.</p> <div style="border: 1px solid black; padding: 5px; text-align: center; margin-top: 10px;"> SAT: [-----] </div> <p>If you can't receive a satellite signal, press the Down [▼] button to display the terrestrial (TER) signal strength meter and adjust your XM Passport System so that the bar is as long as possible.</p> <p>Terrestrial signals are only available in certain areas.</p> <div style="border: 1px solid black; padding: 5px; text-align: center; margin-top: 10px;"> TER: [-----] </div> <p>So long as the signal strength is good, you can enjoy XM Radio by using either satellite or terrestrial reception.</p>

XM Radio Messages

The following messages may appear while using XM radio.

CHECK ANTENNA

The XM Passport System is not connected properly. Check the connection.

UPDATING

The XM user encryption code is being updated. Please wait.

NO SIGNAL

The signal is too weak. Check the XM Passport System connection and reposition it for the best reception.

LOADING

The AV receiver is tuning or decoding audio or text data. Please wait.

OFF AIR

The XM channel you selected is not currently broadcasting. Select another channel.

Common Functions

This section explains functions that can be used with any input source.

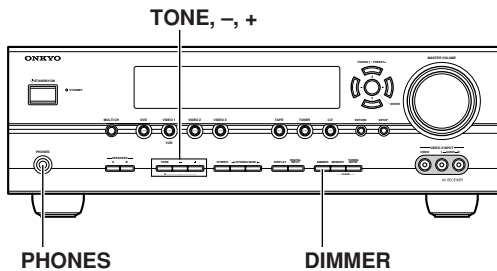
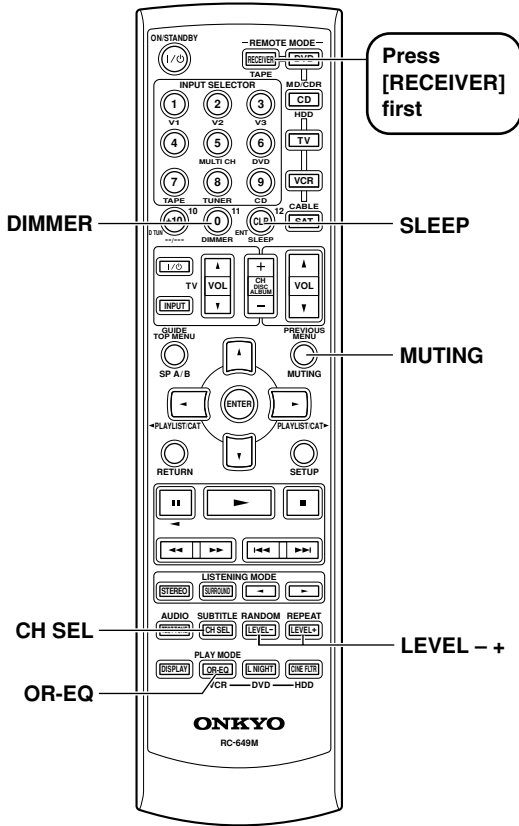

Setting the Display Brightness

You can adjust the brightness of the display.

AV receiver

Remote controller

Press the [DIMMER] button repeatedly to select: dim, dimmer, or normal brightness.

Adjusting the Bass and Treble

You can adjust the bass and treble for the front speakers, except when the Direct or Pure Audio (not North American models) listening mode is selected.

1

Press the AV receiver's [TONE] button repeatedly to select either Bass or Treble.

2

Use the TONE [-]/[+] buttons to adjust.

■ Bass

You can boost or cut low-frequency sounds output by the front speakers from -10 dB to +10 dB in 2 dB steps.

■ Treble

You can boost or cut high-frequency sounds output by the front speakers from -10 dB to +10 dB in 2 dB steps.

Muting the AV Receiver

You can temporarily mute the output of the AV receiver.

MUTING

Press the remote controller's [MUTING] button.

The output is muted and the MUTING indicator flashes on the display.

To unmute the AV receiver, press the remote controller's [MUTING] button again, or adjust the volume. The output is unmuted and the MUTING indicator goes off. Muting is cancelled when the AV receiver is set to Standby.

Using the OptiResponse Equalizer

When using the HT-R540 with the speakers included in this Package, by turning on the OptiResponse equalizer, you can enjoy a powerful sound with movies or music.

Press the remote controller's [OR-EQ] button to turn the Opti-Response equalizer on or off.

Using the Sleep Timer

With the sleep timer, you can set the AV receiver so that it turns off automatically after a specified period.



Press the remote controller's [SLEEP] button repeatedly to select the required sleep time.

You can set the sleep time from 90 to 10 minutes in 10 minute steps.

The SLEEP indicator appears on the display when the sleep timer has been set, as shown. The specified sleep time appears on the display for about 5 seconds, then the previous display reappears.

SLEEP indicator

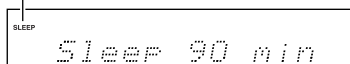

To cancel the sleep timer, press the [SLEEP] button repeatedly until the SLEEP indicator disappears.

To check the remaining sleep time, press the [SLEEP] button. Note that if you press the [SLEEP] button while the sleep time is being displayed, you'll shorten the sleep time by 10 minutes.

Using Headphones

For private listening, you can connect a pair of stereo headphones (1/4-inch phone plug) to the AV receiver's PHONES jack.

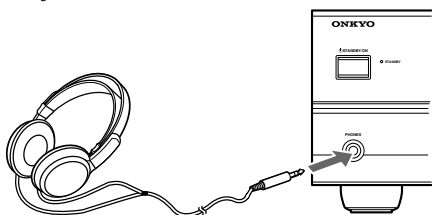

Notes:

- Always turn down the volume before connecting your headphones.
- Speaker sets A and B are turned off while the headphones plug is inserted in the PHONES jack.
- When you connect a pair of headphones, the listening mode is set to Stereo, unless it was set to Pure Audio, Mono, Stereo, or Direct, in which case it stays the same.
- When the multichannel DVD input is selected, only the front left and front right channels can be heard in the headphones.

Adjusting Speaker Levels

You can adjust the volume of each speaker in speaker set A. These temporary adjustments are cancelled when the AV receiver is set to Standby.

1



Use the remote controller's [CH SEL] button to select each speaker, and use the [LEVEL-] and [LEVEL+] buttons to adjust the volume.

You can adjust the volume of each speaker from -12 dB to +12 dB (-15 dB to +12 dB for the subwoofer).



Notes:

- You cannot use this function while the AV receiver is muted.
- Speakers that are set to No or None in the Speaker Configuration cannot be adjusted.

■ Speaker Set B

While speaker set B is on, you can adjust the volume of the left and right speakers, from -12 dB to +12 dB.

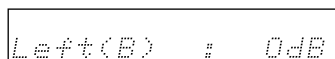

- These settings are stored when the AV receiver is set to Standby.
- While speaker set B is on, you cannot adjust the levels of speaker set A's surround back speakers.

■ Headphones

While a pair of headphones is connected, you can adjust the volume of each headphone speaker, from -12 dB to +12 dB each.

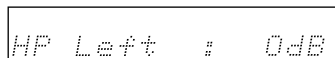

- These settings are stored when the AV receiver is set to Standby.

Using the Listening Modes

Selecting Listening Modes

For a description of each listening mode, see “About the Listening Modes” on page 48.

- The Dolby Digital and DTS listening modes can only be selected if your DVD player is connected to the AV receiver with a digital audio connection (coaxial or optical).
- Listening mode availability depends on the format of the current input signal.
- While a pair of headphones is connected, you can select only the Pure Audio (not North American model), Mono, Direct, or Stereo listening mode.
- The listening modes cannot be selected while speaker set A is off.

Selecting on the AV Receiver

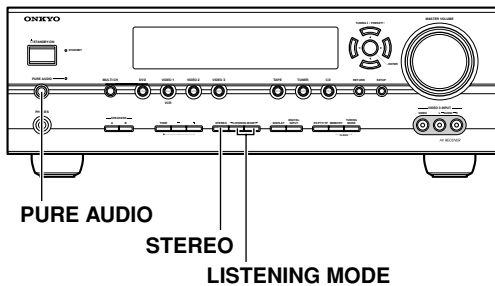

- **[PURE AUDIO] button (not North American model)**
This button selects the Pure Audio listening mode. When this mode is selected, the AV receiver outputs no video signals and its display is turned off. Pressing this button again will select the previous listening mode.
- **[STEREO] button**
This button selects the Stereo listening mode.
- **LISTENING MODE [◀/▶] buttons**
Pressing these buttons repeatedly cycles through all of the listening modes that can be used with the current input source.

Selecting with the Remote Controller

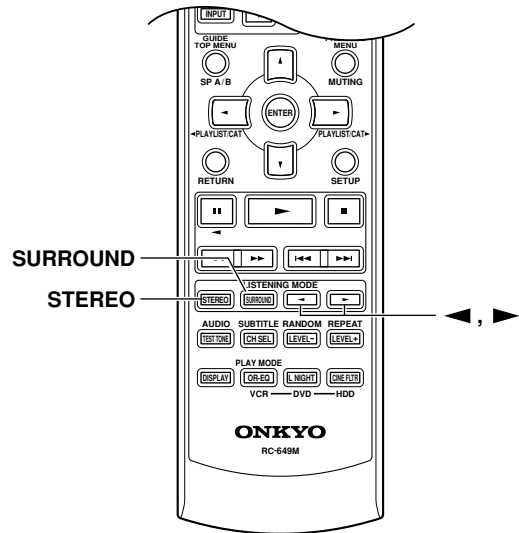

- **[STEREO] button**
This button selects the Stereo listening mode.
- **[SURROUND] button**
This button selects the Dolby Digital and DTS listening modes and the Neural Surround listening mode (North American model only).
- **LISTENING MODE [◀/▶] buttons**
Pressing these buttons repeatedly cycles through all of the listening modes that can be used with the current input source.

Using the Listening Modes—Continued

The following table shows which listening modes can be used with each input signal format.

Source format		Analog, PCM ^{*1}	Dolby Digital				DTS/DTS 96/24 ^{*2}				Multich analog
			3/2.1 2/2.1	2/0	1/0, 1+1	Other	3/2.1 2/2.1	2/0	DTS-ES		
		CD, TV, radio, cassette, etc.	DVD, DTV, etc.				DVD, CD, etc.				DVD
Listening mode											
Pure Audio (Not North American models) Direct		✓	✓	✓	✓	✓	✓	✓	✓	✓	✓
Stereo Mono		✓	✓	✓	✓	✓	✓	✓	✓		
Multich											✓
PLIIx Movie/Music/Game ^{*3} Neo:6 Cinema Neo:6 Music		✓		✓				✓			
Neural Surround (North American models only)		✓ ^{*4}									
Dolby	Dolby D		✓			✓					
	Dolby D + Neo:6 Dolby D EX Dolby D+PLIIx Music		✓								
	Dolby D+PLIIx Movie		✓								
DTS	DTS, DTS 96/24					✓			✓ ^{*5}		
	DTS-ES Discrete							✓			
	DTS-ES Matrix								✓		
	DTS+Neo:6 DTS+Dolby EX DTS+PLIIx Music					✓					
	DTS+PLIIx Movie					✓					
Onkyo Original DSP	Mono Movie Orchestra Unplugged Studio-Mix TV Logic All Ch Stereo Full Mono ^{*6}	✓	✓	✓	✓	✓	✓	✓	✓		

*1. In the Pure Audio and Direct listening modes, 32 kHz, 44.1 kHz, and 48 kHz PCM is processed at 64 kHz, 88.2 kHz, and 96 kHz respectively. In listening modes other than Pure Audio, Direct, and Stereo, 64 kHz, 88.2 kHz, and 96 kHz PCM is processed at 32 kHz, 44.1 kHz, and 48 kHz respectively.

*2. In listening modes other than Pure Audio, Direct, Stereo, and DTS 96/24, DTS 96/24 sources are processed as normal DTS.

*3. If the Surr Back parameter is set to None, or speaker set B is on, normal Pro Logic II is used.

*4. Not available for 88.2 kHz and 96 kHz PCM input signals.

*5. If the Surr Back setting is set to None, or speaker set B is on, normal DTS is used.

*6. Available only when surround speakers are connected.

■ : Only available on 6.1/7.1-channel playback systems. Not available while speaker set B is on.

■ : Only available on 7.1-channel playback systems. Not available while speaker set B is on.

Tip: To check the format of the digital input signal, see “Displaying Source Information” on page 37.

About the Listening Modes

The AV receiver's listening modes can transform your listening room into a movie theater or concert hall, with high fidelity and stunning surround sound.

The illustration shows which speakers are active in each listening mode with 7.1 channel speaker system.

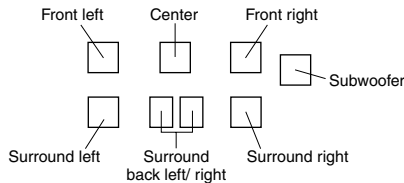

Pure Audio (not North American models)

In this mode, the display and video circuitry are turned off, minimizing possible noise sources for the ultimate in high-fidelity reproduction. (As the video circuitry is turned off, no video signals are output in this mode.)

Direct

In this mode, audio from the input source is output directly with minimal processing, providing high-fidelity reproduction. All of the source's audio channels are output as they are.

Stereo

Sound is output by the front left and right speakers and subwoofer.

Mono

Use this mode when watching an old movie with a mono soundtrack, or use it with the foreign language soundtracks recorded in the left and right channels of some movies. It can also be used with DVDs or other sources containing multiplexed audio, such as karaoke DVDs.

Dolby Pro Logic IIx

Dolby Pro Logic II

Dolby Pro Logic IIx expands any 2-channel source for 7.1-channel playback. It provides a very natural and seamless surround-sound experience that fully envelops the listener. As well as music and movies, video games can also benefit from the dramatic spatial effects and vivid imaging. If you're not using any surround back speakers, **Dolby Pro Logic II** will be used instead of Dolby Pro Logic IIx.

- **PLIIx Movie**

Use this mode with any stereo or Dolby Surround (Pro Logic) movie (e.g., TV, DVD, VHS).

- **PLIIx Music**

Use this mode with any stereo or Dolby Surround (Pro Logic) music source (e.g., CD, radio, cassette, TV, VHS, DVD).

- **PLIIx Game**

Use this mode with video games, especially those that bear the Dolby Pro Logic II logo.

Dolby Digital

Use this mode with DVDs that bear the Dolby Digital logo, and Dolby Digital TV broadcasts. This is the most common digital surround-sound format, and it'll put you right in the middle of the action, just like being in a movie theater or concert hall.

Dolby Digital EX

DTS+Dolby EX

These modes expand 5.1-channel Dolby Digital and DTS sources for 6.1/7.1-channel playback. They're especially suited to Dolby Digital EX soundtracks that include a matrix-encoded surround back channel. The additional channel adds an extra dimension and provides an enveloping surround sound experience, perfect for rotating and fly-by sound effects. Use them with DVDs that bear the Dolby Digital or DTS logo.

Dolby Digital+PLIIx Music

DTS+PLIIx Music

These modes use the Pro Logic IIx Music mode to expand 5.1-channel Dolby Digital and DTS sources for 6.1/7.1-channel playback. Use them with Dolby Digital or DTS 5.1 music sources (e.g., DVD and Dolby Digital TV broadcasts).

Dolby Digital+PLIIx Movie

DTS+PLIIx Movie

These modes use the Pro Logic IIx Movie mode to expand 5.1-channel Dolby Digital and DTS sources for 7.1-channel playback. Use them with Dolby Digital and DTS 5.1 movies (e.g., DVD and select digital TV broadcasts).

DTS

The DTS digital surround-sound format supports up to 5.1 discrete channels and uses less compression for high-fidelity reproduction. Use it with DVDs and CDs that bear the DTS logo.

DTS 96/24

This mode is for use with DTS 96/24 sources. This is high-resolution DTS with a 96 kHz sampling rate and 24-bit resolution, providing superior fidelity. Use it with DVDs that bear the DTS 96/24 logo.

DTS-ES Discrete

This mode is for use with DTS-ES Discrete soundtracks, which use a discrete surround back channel for true 6.1/7.1-channel playback. The seven totally separate audio channels provide better spatial imaging and 360-degree sound localization, perfect for sounds that pan across the surround channels. Use it with DVDs that bear the DTS-ES logo, especially those with a DTS-ES Discrete soundtrack.

DTS-ES Matrix

This mode is for use with DTS-ES Matrix soundtracks, which use a matrix-encoded back-channel for 6.1/7.1-channel playback. Use it with DVDs that bear the DTS-ES logo, especially those with a DTS-ES Matrix soundtrack.



DTS Neo:6

This mode expands any 2-channel source for 6.1-channel playback. It uses six full-bandwidth channels of matrix decoding for matrix-encoded material, providing a very natural and seamless surround sound experience that fully envelops the listener.

- **Neo:6 Cinema**
Use this mode with any stereo movie (e.g., TV, DVD, VHS).
- **Neo:6 Music**
Use this mode with any stereo music source (e.g., CD, radio, cassette, TV, VHS, DVD).

Dolby Digital + Neo:6

This mode uses Neo:6 to expand 5.1-channel Dolby Digital and DTS sources for 6.1/7.1-channel playback. Use it with DVDs that bear the Dolby Digital or DTS logo and feature a 5.1-channel soundtrack.



Neural Surround (North American models only)

Neural Surround represents the latest advancement in surround technology developed for music and is adopted by XM Satellite Radio for digital radio broadcast of surround recordings and live events in surround sound. Neural Surround employs psychoacoustic frequency-domain processing, which allows delivery of a more detailed sound stage, with superior channel separation and localization of audio elements. System playback is scalable from 5.1 to 7.1 multichannel surround playback.

Onkyo Original DSP Modes

Mono Movie

This mode is suitable for old movies and other mono sources. The center speaker outputs the sound as it is, while reverb is applied to the sound output by the other speakers, giving presence to even mono material.

Orchestra

Suitable for classical or operatic music, this mode emphasizes the surround channels in order to widen the stereo image, and simulates the natural reverberation of a large hall.

Unplugged

Suitable for acoustic instruments, vocals, and jazz, this mode emphasizes the front stereo image, giving the impression of being right in front of the stage.

Studio-Mix

Suitable for rock or pop music, listening to music in this mode creates a lively sound field with a powerful acoustic image, like being at a club or rock concert.

TV Logic

This mode adds realistic acoustics to TV shows produced in a TV studio, surround effects to the entire sound, and clarity to voices.

All Ch Stereo

Ideal for background music, this mode fills the entire listening area with stereo sound from the front, surround, and surround back speakers.

Full Mono

In this mode, all speakers output the same sound in mono, so the sound you hear is the same regardless of where you are within the listening room.

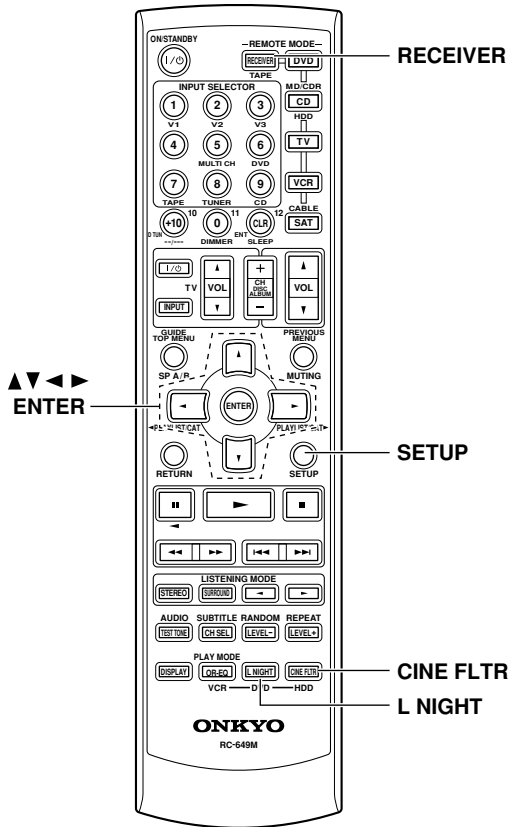

Using the Late Night Function (Dolby Digital only)

With the Late Night function, you can reduce the dynamic range of Dolby Digital material so that you can still hear quiet parts even when listening at low volume levels—ideal for watching movies late at night when you don't want to disturb anyone.

1 Press the [RECEIVER] REMOTE MODE button, and then press the [L NIGHT] button repeatedly to select:

- Off:** Late Night function off.
- Low:** Small reduction in dynamic range.
- High:** Big reduction in dynamic range.

Notes:

- The effect of the Late Night function depends on the Dolby Digital material that you are playing, and with some material there will be little or no effect.
- The Late Night function is set to Off when the AV receiver is set to Standby.

Using the CinemaFILTER

With the CinemaFILTER, you can soften overly bright movie soundtracks, which are typically mixed for reproduction in a movie theater.

CinemaFILTER can be used with the following listening modes: Dolby Digital, Dolby Digital EX, PLII/IIx Movie, DTS, DTS-ES, DTS Neo:6 Cinema, DTS 96/24, Dolby/DTS+PLIIx Movie, Dolby/DTS+Neo:6, and DTS+Dolby EX.

1 Press the [RECEIVER] REMOTE MODE button, and then press the [CINE FLTR] button repeatedly to select:

- On:** CinemaFILTER on.
- Off:** CinemaFILTER off.

Using the Audio Adjust Settings

The Audio Adjust settings only affect speaker set A.

1 Press the [RECEIVER] button followed by the [SETUP] button.

2 Use the Up and Down [▲]/[▼] buttons to select "4. Audio Adjust," and then press [ENTER].

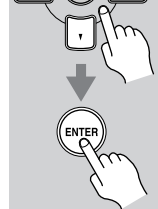
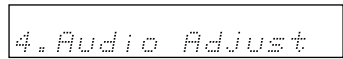

3 Use the Left and Right [◀]/[▶] buttons to change the setting. Press the Down [▼] button to select the next setting. Repeat this step for the other settings.

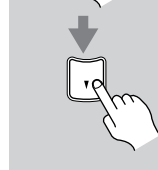

4



Press the [SETUP] button.

Setup closes.

The Audio Adjust settings are explained below.

Input Channel Settings

■ **Multiplex**

This setting determines which channel is output from a stereo multiplex source. Use it to select audio channels or languages with multiplex sources, multilingual TV broadcasts, and so on.

Main: The main channel is output (default).

Sub: The sub channel is output.

M/S: Both the main and sub channels are output.

■ **Mono (2ch)**

This setting determines which channel is output when the Mono listening mode is used with a stereo source.

L+R: Both the left and right channels are output (default).

L: Only the left channel is output.

R: Only the right channel is output.

PLII and PLIIX Music Mode Settings

These settings apply to only 2-channel (stereo) sources.

■ **Panorama**

With this setting, you can broaden the width of the front stereo image when using the Pro Logic II Music or Pro Logic IIX Music listening mode.

On: Panorama function on.

Off: Panorama function off (default).

■ **Dimension**

With this setting, you can move the sound field forward or backward when using the Pro Logic II Music or Pro Logic IIX Music listening mode. The default value is 3. It can be adjusted from 0 to 6. Higher settings move the sound field forward. Lower settings move it backward. If the stereo image feels too wide, or there's too much surround sound, move the sound field forward to improve the balance. Conversely, if the stereo image feels like it's in mono, or there's not enough surround sound, move it backward.

■ **Center Width**

With this setting, you can adjust the width of the sound from the center speaker when using the Pro Logic II Music or Pro Logic IIX Music listening mode. Normally, the center channel sound is output by only the center speaker. (If you're not using a center speaker, the center channel sound will be distributed to the front left and right speakers to create a phantom center). This setting

adjusts the front left, right, and center mix, allowing you to adjust the weight of the center channel sound. It can be adjusted from 0 to 7 (default value is 3).

DTS Neo:6 Music Mode Setting

■ **Center Image**

The DTS Neo:6 Music listening mode creates 6-channel surround sound from 2-channel (stereo) sources. With this setting, you can specify by how much the front left and right channel output is attenuated in order to create the center channel. It can be adjusted from 0 to 5 (default value is 2). This setting has no effect if no center speaker is connected.

When set to 0, the front left and right channel output is attenuated by half (–6 dB), giving the impression that the sound is located centrally. This setting works well when the listening position is considerably off center. When set to 5, the front left and right channels are not attenuated, maintaining the original stereo balance.

Dolby Digital EX Input Signal Setting

■ **Dolby EX**

This setting determines how Dolby Digital EX signals are handled. This setting is unavailable if no surround back speakers are connected or speaker set B is on.

Auto: If the source signal contains a Dolby Digital EX flag, the Dolby Digital EX listening mode is used (default).

Manual: You can select Pro Logic IIX Movie, Pro Logic IIX Music, Dolby Digital, or Dolby Digital EX.

Multichannel Subwoofer Setting

■ **SW Sens**

On some DVD players, the signal from the multichannel subwoofer output is 15 dB higher than normal. You can change the subwoofer sensitivity to match your DVD player. Note that this setting only affects signals connected to the SUBWOOFER input jack of the multichannel DVD input.

You can select 0 dB (default), +5 dB, +10 dB, or +15 dB. If you find that your subwoofer is too loud, try the +10 dB or +15 dB setting.

Advanced Setup

Advanced Speaker Settings

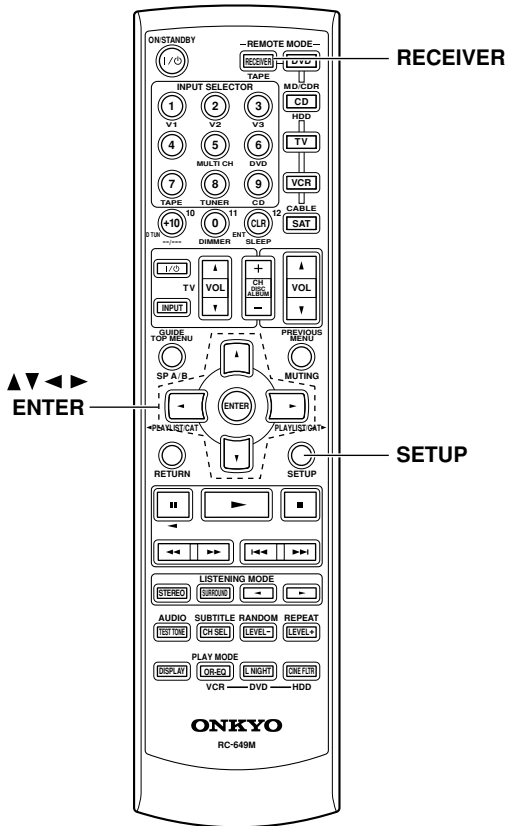

Speaker Distance

The speaker distance setting cannot be changed while a pair of headphones is connected, speaker set B is on, or the multichannel input is being used.

To get the best from surround sound, it's important that the sound from each speaker reaches the listener at the same time. To achieve this, you need to specify the distance from each speaker to the listening position.

- 1** Measure and make a note of the distance from each speaker to the listening position.
- 2** Press the [RECEIVER] button followed by the [SETUP] button on the remote controller.

- 3** Use the Up and Down [**▲**]/[**▼**] buttons to select "2. SP Distance," and then press the [ENTER] button.

2. SP Distance
- 4** While "Unit" is displayed, use the Left and Right [**◀**]/[**▶**] buttons to select "feet" or "meters".

feet: Distances in feet. Can be set from 1 to 30 feet in 1-foot steps.

meters: Distances in meters. Can be set from 0.3 to 9 meters in 0.3-meter steps.
- 5** Use the Down [**▼**] button to select "Front," and use the Left and Right [**◀**]/[**▶**] buttons to specify the distance for the "front speakers," then press the Down [**▼**] button to select the next speaker.
- 6** Repeat step 5 for all speakers.

Note:
Speakers that you set to No or None in the Speaker Configuration (page 54) cannot be selected.
- 7** Press the [SETUP] button. Setup closes.

Notes:

- The Center and Subwoofer distances can be set up to 5 ft. (1.5 m) more or less than the Front distance. For example, if the Front distance is set to 20 ft. (6 m), the Center and Subwoofer distances can be set between 15 and 25 ft. (4.5 and 7.5 m).
- The Surround and Surround Back distances can be set up to 5 ft. (1.5 m) more or 15 ft. (4.5 m) less than the Front distance. For example, if the Front distance is set to 20 ft. (6 m), the SurrRight, Surr Left, Surr Back R, and Surr Back L distances can be set between 5 and 25 ft. (1.5 and 7.5 m).

Speaker Levels

With this function, you can adjust the volume of each speaker so that all speakers can be heard equally at the listening position.

The speaker levels cannot be adjusted while a pair of headphones is connected, speaker set B is on, or the AV receiver is muted.

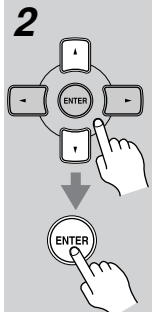
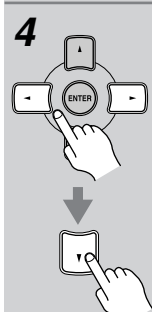
1	 <p>Press the [RECEIVER] button followed by the [SETUP] button on the remote controller.</p>
2	 <p>Use the Up and Down [▲]/[▼] buttons to select “3. Level Cal,” and then press the [ENTER] button.</p> <p>A pink noise test tone is output by the front left speaker.</p> <div style="border: 1px solid black; padding: 5px; width: fit-content; margin: 10px auto;">3. Level Cal</div>
3	<p>Turn up the volume so that you can hear the test tone sufficiently.</p> <p>While each speaker outputs the test tone, its name appears on the display, as shown.</p> <div style="border: 1px solid black; padding: 5px; width: fit-content; margin: 10px auto;">Left # 0dB</div>
4	 <p>Use the Left and Right [◀]/[▶] buttons to adjust the speaker level, and use the Down [▼] button to select the next speaker.</p> <p>The level can be adjusted from -12 to +12 dB in 1 dB steps (-15 to +12 dB for the subwoofer).</p>

5 Repeat step 4 so that the level of the test tone from each speaker is the same.

Speakers that you set to No or None in the Speaker Configuration (page 54) do not output the test tone.

6 Press the [SETUP] button.

Setup closes.

Don't forget to turn down the volume if you turned it up while setting the levels.

Note:

- A quicker way to adjust the speaker levels is to press the remote controller's [TEST TONE] button to output the test tone, use the [LEVEL-] and [LEVEL+] buttons to adjust the levels, and use the [CH SEL] button to select the speakers.

Speaker Configuration, Crossover Frequency, and Double Bass settings only need to be changed if you're not using the speakers in this package.

These settings cannot be changed while headphones are connected, speaker set B is on, or the multichannel DVD input is being used.

Speaker Configuration

This section explains how to specify which speakers are connected and their sizes.

For speakers with a cone diameter larger than 6-1/2 inches (16 cm), specify **Large** (full band). For those with a smaller diameter, specify **Small** (default crossover 100 Hz).

The crossover frequency can be changed on page 55.

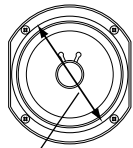

Cone diameter

<p>1</p>	<p>Press the [RECEIVER] button followed by the [SETUP] button.</p>
<p>2</p>	<p>Use the Up and Down [▲]/[▼] buttons to select "1. SP Config," and then press the [ENTER] button.</p> <div style="border: 1px solid black; padding: 5px; width: fit-content; margin: 10px auto;">1. SP Config</div>
<p>3</p>	<p>While the Subwoofer setting is selected, use the Left and Right [◀]/[▶] buttons to select Yes or No.</p> <p>Yes: Select if a subwoofer is connected.</p> <p>No: Select if no subwoofer is connected.</p>

<p>4</p>	<p>Use the Down [▼] button to select "Front," and then use the Left and Right [◀]/[▶] buttons to select Small or Large.</p> <p>Small: Select if the front speakers are small.</p> <p>Large: Select if the front speakers are large.</p> <p>Note:</p> <ul style="list-style-type: none"> If the Subwoofer setting in step 3 is set to No, this setting is fixed at Large and does not appear.
<p>5</p>	<p>Use the Down [▼] button to select "Center," and then use the Left and Right [◀]/[▶] buttons to select Small, Large, or None.</p> <p>Small: Select if the center speaker is small.</p> <p>Large: Select if the center speaker is large.</p> <p>None: Select if no center speaker is connected.</p> <p>Note:</p> <ul style="list-style-type: none"> If the Front setting in step 4 is set to Small, the Large option cannot be selected.
<p>6</p>	<p>Use the Down [▼] button to select "Surround," and then use the Left and Right [◀]/[▶] buttons to select Small, Large, or None.</p> <p>Small: Select if the surround speakers are small.</p> <p>Large: Select if the surround speakers are large.</p> <p>None: Select if no surround speakers are connected.</p> <p>Note:</p> <ul style="list-style-type: none"> If the Front setting in step 4 is set to Small, the Large option cannot be selected.

7

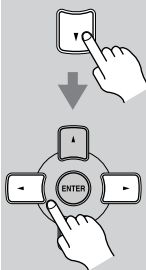

Use the Down [▼] button to select “Surr Back,” and use the Left and Right [◀]/[▶] buttons to select **Small**, **Large**, or **None**.

Small: Select if the surround back speakers are small.

Large: Select if the surround back speakers are large.

None: Select if no surround back speakers are connected.

Notes:

- If the Surround setting in step 6 is set to None, this setting does not appear.
- If the Surround setting in step 6 is set to Small, the Large option cannot be selected.

8

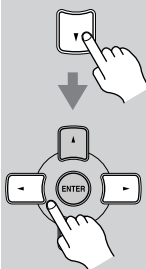

Use the Down [▼] button to select “Surr Back Ch,” and use the Left and Right [◀]/[▶] buttons to select **2ch** or **1ch**.

2ch: Select if two (left and right) surround back speakers are connected.

1ch: Select if one surround back speaker is connected.

Note:

- If the Surround and Surr Back settings in steps 6 and 7 are set to None, this setting does not appear.

Continue with step 9 of the “Crossover Frequency” setting.

Crossover Frequency

This setting only applies to the speakers that you specified as **Small** in the “Speaker Configuration” on page 54. To get the best bass performance from your speaker system, you need to set the crossover frequency according to the size and frequency response of your speakers

9

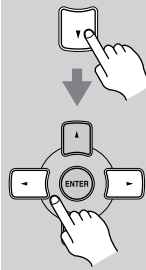

Use the Down [▼] button to select “Crossover,” and then use the Left and Right [◀]/[▶] buttons to select a crossover frequency.

Use the diameter of the smallest speaker in your system when choosing the crossover frequency.

Speaker cone diameter	Crossover frequency
Over 8 in. (20 cm)	40/50/60Hz*
6-1/2 to 8 in. (16–20 cm)	80Hz
5-1/4 to 6-1/2 in. (13–16 cm)	100Hz (default)
3-1/2 to 5-1/4 in. (9–13 cm)	120Hz
Under 3-1/2 in. (9 cm)	150/200Hz*

*Choose the setting suitable for the speaker.

Continue with step 10 of the “Double Bass” setting below.

Notes:

- For a more accurate setting, look up the frequency response in the manuals supplied with your speakers and set accordingly.
- Choose a higher crossover frequency if you want more sound from your subwoofer.

Double Bass

With the Double Bass function, you can boost bass output by feeding bass sounds from the front left and right channels to the subwoofer. This function can be set only if the Subwoofer setting (step 3) is set to Yes, and the Front setting (step 4) is set to Large in the Speaker Configuration on page 54.

10

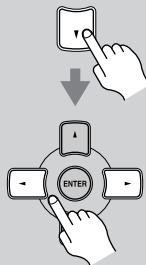

Use the Down [▼] button to select “Double Bass,” and then use the Left and Right [◀]/[▶] buttons to select:

On: Double Bass function on. Bass from the front left and right channels is also fed to the subwoofer (default).

Off: Double Bass function off.

11



Press the [SETUP] button. Setup closes.

Digital Input Signal Formats

The following table shows the display indicator for each digital signal format.

Format	Display
Dolby Digital	D
DTS	
PCM	PCM

Normally, the AV receiver detects the signal format automatically. However, if you experience either of the following issues when playing PCM or DTS material, you can specify the signal format as either PCM or DTS:

- If the beginnings of tracks from a PCM source are cut off, try the PCM setting.
- If noise is produced when fast forwarding or reversing a DTS CD, try the DTS setting.

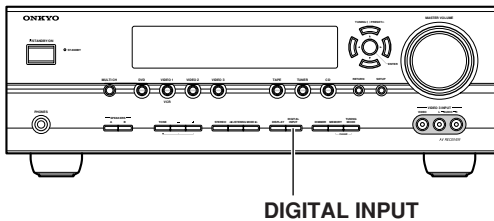

1 Press and hold the AV receiver's [DIGITAL INPUT] button for about 3 seconds.

2 While "Auto" is displayed (about 3 seconds), press the [DIGITAL INPUT] button repeatedly to select: PCM, DTS, or Auto.
PCM: Only PCM format input signals will be heard. If the input signal is not PCM, the PCM indicator will flash and there will be no sound.
DTS: Only DTS format input signals will be heard. If the input signal is not DTS, the DTS indicator will flash and there will be no sound.
Auto (default): The format is detected automatically. If no digital input signal is present, the corresponding analog input is used instead.

Correcting Sound and Picture Sync

When using progressive scanning on your DVD player, you may find that the picture and sound are out of sync. With this setting, you can correct this by delaying the audio signals. You can set it from 0 to 100 milliseconds (ms) in 20 millisecond steps.

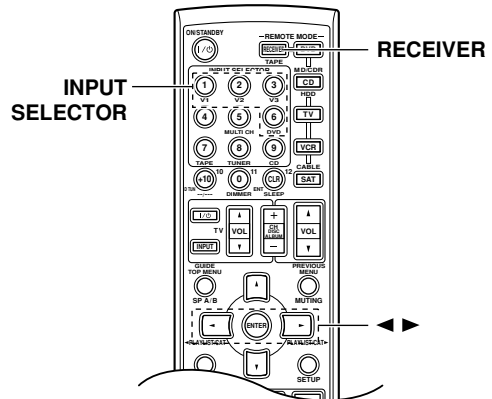

1 Press the [RECEIVER] REMOTE MODE button.

2 Press and hold, for more than 4 seconds, the input selector button for the input source that you want to correct.
 This can be the [DVD], [VIDEO 1], [VIDEO 2], or [VIDEO 3] input source.

3 Use the Left and Right [◀/▶] buttons to adjust the delay from 0 to 100 milliseconds in 20 millisecond steps.

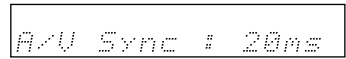

Note:

- This setting is not available when the Pure Audio listening mode is used, or the Direct listening mode is used with an analog input signal.

Recording

This section explains how to record the selected input source to a component with recording capability, and how to record audio and video from different sources.

Recording the Input Source

You can only record to a component that's connected to the TAPE OUT or VIDEO 1 OUT jacks.

See pages 22–33 for information on connecting your AV components.

1	Use the input selector buttons to select the component that you want to record. Audio signals from the selected input source are output by the TAPE OUT and VIDEO 1 OUT jacks. You can listen to the source while recording. The AV receiver's VOLUME control has no effect on recording.
2	On your recorder, start recording.
3	Start playback on the source component.

Notes:

- You cannot record from a component that's connected to a digital input. Only analog inputs can be recorded.
- The surround sound effects provided by the listening modes cannot be recorded.
- You cannot record from a component that's connected to the multichannel DVD input.
- If you select another input source while recording, that input source will be recorded instead.
- While the Pure Audio listening mode is selected, the VIDEO 1 OUT V and S jacks don't output video signals, so select another mode when recording.

Recording Audio and Video from Separate Sources

You can overdub audio onto your video recordings by simultaneously recording audio and video from two separate sources. This is possible because only the audio source is switched when an audio-only input source, such as TAPE, TUNER, or CD, is selected, the video source remains the same.

In the following example, audio from the CD player connected to the CD IN jacks, and video from the camcorder connected to the VIDEO 3 INPUT VIDEO jack are recorded by the VCR connected to the VIDEO 1 OUT jacks.

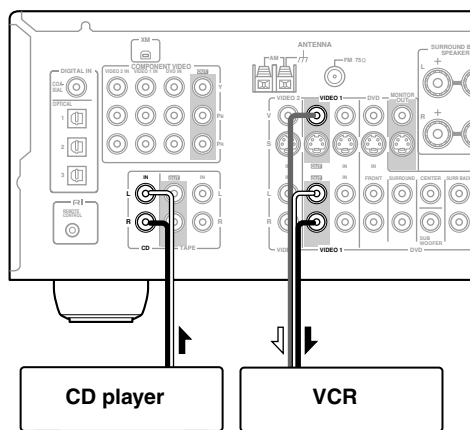
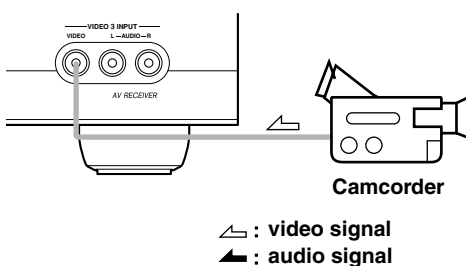

1. Prepare the camcorder and CD player for playback.
2. Prepare the VCR for recording.
3. Press the [VIDEO 3] input selector button.
4. Press the [CD] input selector button.
This selects the CD player as the audio source, but leaves the camcorder as the video source.
5. Start recording on the VCR, then start playback on the camcorder and CD player.
Video from the camcorder and audio from the CD player are recorded by the VCR.

Controlling Other Components

You can use the AV receiver's remote controller (RC-649M) to control your other AV components, including those made by other manufacturers. This section explains how to enter the necessary remote control code for the component that you want to control (e.g., DVD player, TV, or VCR).

Entering Remote Control Codes

To control another component, you must first enter the appropriate remote control code to a REMOTE MODE button. You'll need to enter a code for each component that you want to control.

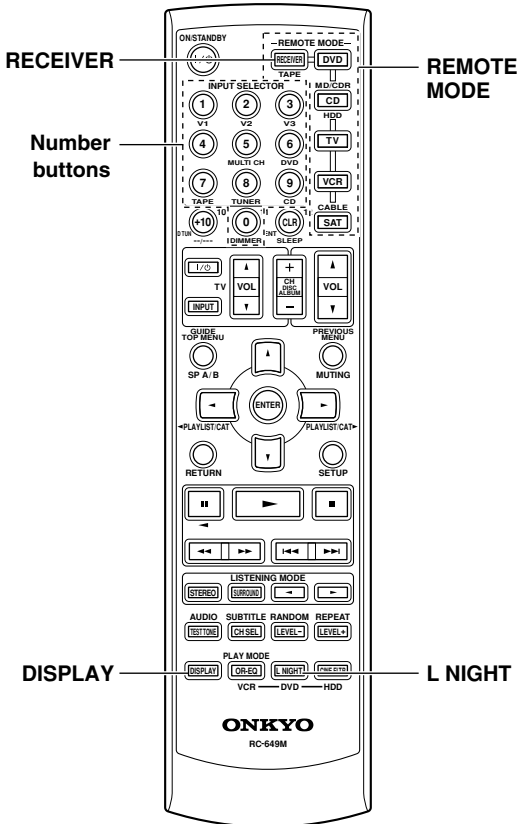

1 Look up the appropriate remote control code in the separate Remote Control Codes list. The codes are organized by category (e.g., DVD player, TV, etc.).

2 While holding down the REMOTE MODE button that you want to set, press the [DISPLAY] button for 3 seconds. The REMOTE MODE button lights up.

The diagram shows a vertical list of REMOTE MODE buttons: DVD, MD/CDR, CD, HDD, TV, VCR, CABLE, and SAT. A hand is shown holding down the TV button. Below this, a hand is shown pressing the DISPLAY button.

3 Within 30 seconds, use the number buttons to enter the 4-digit remote control code. The REMOTE MODE button flashes twice.

The diagram shows a grid of number buttons (1-9, 0) with labels: 1 (V1), 2 (V2), 3 (V3), 4, 5, 6, 7 (TAPE), 8 (TUNER), 9 (CD), 0 (DIMMER), and ENT.

4 Press the REMOTE MODE button again to select the remote controller mode, point the remote controller at the component, and check the operation. If the remote controller doesn't work as expected, and several remote codes are listed, try each one in turn and use the one that works best.

- Notes:**
- A remote control code cannot be entered for the [RECEIVER] REMOTE MODE button.
 - The remote control codes provided are correct at the time of printing, but are subject to change.

Remote Control Codes for Onkyo Components Connected via **RI**

Onkyo components that are connected via **RI** are controlled by pointing the remote controller at the AV receiver, not the component. This allows you to control components that are out of view, in a rack, for example.

- 1** Make sure the Onkyo component is connected with an **RI** cable and an analog audio cable (RCA).
See page 33 for details.
- 2** Enter the appropriate remote control code for the [DVD] or [CD] REMOTE MODE button.
[DVD] REMOTE MODE button
1612: Onkyo DVD player with **RI**
[CD/MD/CDR/HDD] REMOTE MODE button
1327: Onkyo CD player with **RI**
1808: Onkyo MD recorder with **RI**
1322: Onkyo CD recorder with **RI**
1993: HDD-compatible component with **RI**
See the previous page for how to enter remote control codes.
- 3** Press the [DVD] or [CD] REMOTE MODE button, point the remote controller at the AV receiver, and operate the component.

If you want to control an Onkyo component by pointing the remote controller directly at it, or you want to control an Onkyo component that's not connected via **RI**, use the following remote control codes:

- [DVD] REMOTE MODE button
0627: Onkyo DVD player without **RI** (default)
- [CD/MD/CDR/HDD] REMOTE MODE button
1817: Onkyo CD player without **RI** (default)
0868: Onkyo MD recorder without **RI**
1323: Onkyo CD recorder without **RI**
1990: HDD-compatible component without **RI**

Note:

If you connect an **RI**-capable Onkyo MD recorder, CD recorder, or HDD-compatible component to the TAPE IN/OUT or VIDEO 2 jacks, for remote operation to work properly, you must set the Input Display to MD, CDR, or HDD (see page 35).

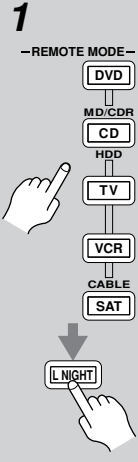
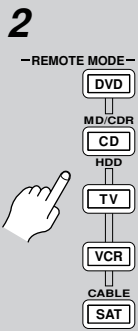

Resetting REMOTE MODE Buttons

You can reset a REMOTE MODE button to its default remote control code.

- 1** While holding down the REMOTE MODE button that you want to reset, press the [L NIGHT] button for 3 seconds.
The REMOTE MODE button lights up.

- 2** Press the REMOTE MODE button again.
The REMOTE MODE button flashes twice, indicating that it's been reset.
The [DVD] and [CD] REMOTE MODE buttons are preprogrammed with remote control codes for controlling Onkyo DVD players and CD players respectively. When these buttons are reset, the preprogrammed code is restored.

Resetting the Remote Controller

You can reset the remote controller to its default settings.

- 1** While holding down the [RECEIVER] REMOTE MODE button, press the [L NIGHT] button for 3 seconds.
The [RECEIVER] button lights up.

- 2** Press the [RECEIVER] REMOTE MODE button again.
The [RECEIVER] button flashes twice, indicating that it's been reset.

Controlling Other Components—Continued

To control another component, point the remote controller at it and use the buttons explained below. (You must select the appropriate remote control mode first.) With some AV components, certain buttons may not work as expected, and some may not work at all.

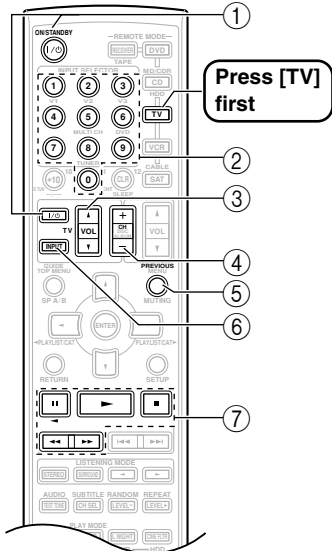
■ Controlling a TV



- ① **[ON/STANDBY], TV [⏻/⏻]***
Sets the TV to On or Standby.
- ② **Number buttons**
Enter numbers.
- ③ **TV VOL [▲]/[▼]***
Adjusts the TV's volume.
- ④ **[CH +/-]**
Selects channels on the TV.
- ⑤ **[PREVIOUS]**
Selects the previous channel.
- ⑥ **[TV INPUT]***
Selects the TV's VCR input.
- ⑦ **[⏸], [▶], [⏹], [⏮], [⏭]**
Operates the VCR.

* Buttons marked with an asterisk (*) are exclusively for controlling a TV and can be used at any time regardless of the current remote controller mode.

■ Controlling a VCR

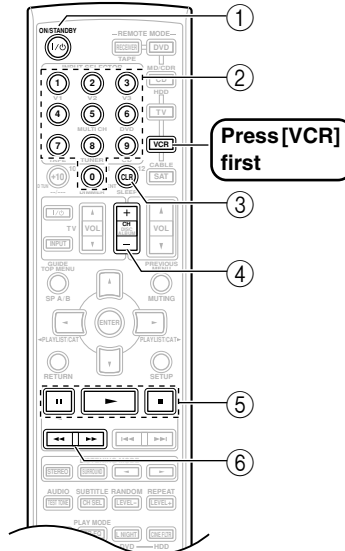

- ① **[ON/STANDBY]**
Sets the VCR to On or Standby.
- ② **Number buttons**
Select channels.
- ③ **[CLR]**
Cancels functions.
- ④ **[CH +/-]**
Selects channels on the VCR.
- ⑤ **[⏸], [▶], [⏹]**
Pause, Play, Stop.
- ⑥ **[⏮], [⏭]**
Rewind and Fast forward.

■ Controlling a Satellite or Cable Receiver

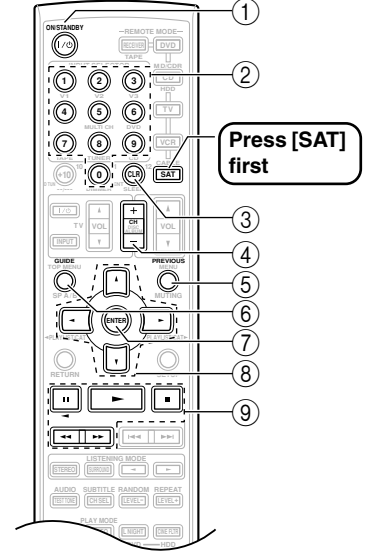

- ① **[ON/STANDBY]**
Sets the satellite/cable receiver to On or Standby.
- ② **Number buttons**
Enter numbers.
- ③ **[CLR]**
Cancels functions.
- ④ **[CH +/-]**
Selects satellite/cable channels.
- ⑤ **[PREVIOUS]**
Selects the previous channel.
- ⑥ **[GUIDE]**
Displays the program guide.
- ⑦ **[ENTER]**
Confirms the selection.
- ⑧ **[▲]/[▼]/[◀]/[▶]**
Selects menu items.
- ⑨ **[⏸], [▶], [⏹], [⏮], [⏭]**
Operates the VCR.

Troubleshooting

If you have any trouble using the 7.1ch Home Theater System, look for a solution in this section.

If you can't resolve the issue yourself, try resetting the AV receiver before contacting your Onkyo dealer.

To reset the AV receiver to its factory defaults, turn it on and, while holding down the [VIDEO 1] button, press the [STANDBY/ON] button. "Clear" will appear on the display and the AV receiver will enter Standby mode.

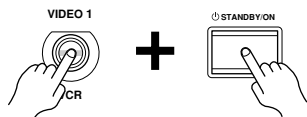

Note that resetting the AV receiver will delete your radio presets and custom settings.

Power

Can't turn on the AV receiver

- Make sure that the power cord is plugged into the wall outlet properly.
- Unplug the power cord from the wall outlet, wait 5 seconds or more, then plug it in again.

The AV receiver turns off as soon as it's turned on

- The amp protection circuit has been activated. Remove the power cord from the wall outlet immediately. Disconnect all speaker cables and input sources, and leave the AV receiver with its power cord disconnected for 1 hour. After that, reconnect the power cord and set the volume to maximum. If the AV receiver stays on, set the volume to minimum, disconnect the power cord, and reconnect your speakers and input sources. If the AV receiver turns off when you set the volume to maximum, disconnect the power cord, and contact your Onkyo dealer.

Audio

There's no sound or it's very quiet

- Make sure that the digital input source is selected properly (page 35). Press the [DIGITAL INPUT] button repeatedly.
- Make sure the speaker set A or B is on (page 5).
- Make sure that all audio connecting plugs are pushed in all the way (page 22).
- Make sure that the polarity of the speaker cables is correct, and that the bare wire is in contact with metal part of each speaker terminal (page 19)
- Make sure that the speaker cables are not shorting.
- Check the volume. It can be set to MIN, 1 through 79, or MAX (page 36). The AV receiver is designed for home theater enjoyment and has a wide volume range for precise adjustment.

- If the MUTING indicator is shown on the display, press the remote controller's [MUTING] button to unmute the AV receiver (page 44).
- While a pair of headphones is connected to the PHONES jack, no sound is output by the speakers (page 45).
- Check the digital audio output settings on the connected device. On some games consoles, such as those that can play DVDs, the default setting is off.
- With some DVD-Video discs, you need to select an audio format from a menu.
- If your turntable doesn't have a phono preamp built-in, you must connect one between it and the AV receiver. If your turntable uses an MC cartridge, you must connect an MC head amp, or an MC transformer and a phono preamp.
- Specify the speaker distances and adjust the individual speaker levels (pages 52, 53).
- The input signal format is set to PCM or DTS. Set it to Auto (page 56).

Only the front speakers produce sound

- When the Stereo or Mono listening mode is selected, only the front speakers and subwoofer produce sound.
- Make sure the speakers are configured correctly (page 54).

Only the center speaker produces sound

- If you use the Pro Logic Ix Movie, Pro Logic Ix Music, or Pro Logic Ix Game listening mode with a mono source, such as an AM radio station or mono TV program, the sound is concentrated in the center speaker.
- Make sure the speakers are configured correctly (page 54).

The surround speakers produce no sound

- When the Stereo or Mono listening mode is selected, the surround speakers produce no sound (page 48).
- Depending on the source and current listening mode, not much sound may be produced by the surround speakers. Try selecting another listening mode.
- Make sure the speakers are configured correctly (page 54).

The center speaker produces no sound

- When the Stereo or Mono listening mode is selected, the center speaker produces no sound (page 48).
- Make sure the speakers are configured correctly (page 54).

The surround back speakers produce no sound

- While speaker set B is on, speaker set A is reduced to 5.1-channel playback and the surround back speakers produce no sound.

- The surround back speakers are not used with all listening modes. Select another listening mode (page 48).
- Not much sound may be produced by the surround back speakers with some sources.
- Make sure the speakers are configured correctly (page 54).

The subwoofer produces no sound

- The level of the input signal was too low so the subwoofer entered Standby mode. Increase the subwoofer level slightly on the HT-R540.
- Make sure that the subwoofer's [POWER] switch is set to ON (not North American models).
- The subwoofer's OUTPUT LEVEL control is set at minimum. Turn it up.
- The subwoofer outputs no sound while only speaker set B is on. Turn on speaker set A.
- When you play source material that contains no information in the LFE channel, the subwoofer produces no sound.
- Make sure the speakers are configured correctly (page 54).

Speaker set B produces no sound

- Speaker set B only outputs sources that are connected to an analog input. Make sure that the analog audio cables are connected properly.

There's no sound with a certain signal format

- Check the digital audio output setting on the connected device. On some games consoles, such as those that can play DVDs, the default setting is off.
- With some DVD-Video discs, you need to select an audio output format from a menu.

Can't get 6.1- or 7.1-channel playback

- While speaker set B is on, speaker set A is reduced to 5.1-channel playback.

The volume cannot be set to 79

- When the volume level of each speaker has been adjusted (pages 45, 53), the maximum possible volume may be reduced.

Noise can be heard

- Using cable ties to bundle audio cables with power cords, speaker cables, and so on may degrade the audio performance, so don't do it.
- An audio cable may be picking up interference. Try repositioning your cables.

The Late Night function doesn't work

- Make sure the source material is Dolby Digital (page 50).

The multichannel DVD input doesn't work

- Check the multichannel DVD input connections (page 26).
- To select the multichannel DVD input, press the [MULTI CH] input selector button.
- Check the audio output settings on your DVD player.

About DTS signals

- When playing DTS program material, using the pause, fast forward, or fast reverse function on your player may produce a short audible noise. This is not a malfunction.
- When DTS program material ends and the DTS bitstream stops, the AV receiver remains in DTS listening mode and the DTS indicator remains on. This is to prevent noise when you use the pause, fast forward, or fast reverse function on your player. If you switch your player from DTS to PCM, because the AV receiver does not switch formats immediately, you may not hear any sound, in which case you should stop your player for about 3 seconds, and then resume playback.
- With some CD players, you won't be able to playback DTS material properly even though your player is connected to a digital input on the AV receiver. This is usually because the DTS bitstream has been processed (e.g., output level, sampling rate, or frequency response changed) and the AV receiver doesn't recognize it as a genuine DTS signal. In such cases, you may hear noise.

Video

There's no picture

- Make sure that all video connecting plugs are pushed in all the way (page 22).
- Make sure that each video component is properly connected.
- The AV receiver does not convert between formats, so if a video source component is connected to a component video input, your TV must be connected to the component video output (page 23).
- On your TV, make sure that the video input to which the AV receiver is connected is selected.
- While the Pure Audio listening mode (not North American model) is selected, the video circuits are turned off and the AV receiver outputs no video signals.

Tuner

Reception is noisy, stereo FM reception suffers from hiss, or the FM STEREO indicator doesn't appear

- Relocate your antenna.
- Move the AV receiver away from your TV or computer.
- Listen to the station in mono (page 38).
- When listening to an AM station, operating the remote controller may cause noise.
- Passing cars and airplanes can cause interference.
- Concrete walls weaken radio signals.
- If nothing improves the reception, install an outdoor antenna.

Remote Controller

The remote controller doesn't work

- Make sure that the batteries are installed with the correct polarity (page 13).
- Make sure that the remote controller is not too far away from the AV receiver, and that there's no obstruction between the remote controller and the AV receiver's remote control sensor (page 13).
- Make sure you've selected the correct remote controller mode (page 14).
- Make sure you've entered the correct remote control code (page 58).

Can't control other components

- Make sure you've selected the correct remote controller mode (page 14).
- If you've connected an **RI**-capable Onkyo MD recorder, CD recorder, or next generation HDD-compatible component to the TAPE IN/OUT jacks, or a DS-A1 Remote Interactive Dock to the VIDEO 2 IN jacks, for the remote controller to work properly, you must set the Input Display to MD, CDR, or HDD (see page 35).
- The entered remote control code may not be correct. If more than one code is listed, try each one.
- With some AV components, certain buttons may not work as expected, and some may not work at all.
- To control an Onkyo component that's connected via **RI**, point the remote controller at the AV receiver. Be sure to enter the appropriate remote control code first (see page 59).
- To control an Onkyo component that's not connected via **RI**, or another manufacturer's component, point the remote controller at the component. Be sure to enter the appropriate remote control code first (see page 58).

Recording

Can't record

- On your recorder, make sure the correct input is selected.
- To prevent signal loops and damage to the AV receiver, input signals are not fed through to outputs with the same name (e.g., TAPE IN to TAPE OUT, or VIDEO 1 IN to VIDEO 1 OUT).
- When the Pure Audio listening mode is selected, recording is not possible because no video signals are output. Select another listening mode.

Others

The sound changes when I connect my headphones

- When a pair of headphones is connected, the listening mode is set to Stereo, unless it's already set to Stereo, Mono, Direct, or Pure Audio (not North American model).

The display doesn't work

- The display is turned off when the Pure Audio (not North American model) listening mode is selected.

How do I change the language of a multiplex source

- Use the "Multiplex" setting on the "4. Audio Adjust" menu to select Main or Sub (page 51).

The **RI** functions don't work

- To use **RI**, you must make an **RI** connection and an analog audio connection (RCA) between the component and AV receiver, even if they are connected digitally (page 33).

The AV receiver contains a microcomputer for signal processing and control functions. In very rare situations, severe interference, noise from an external source, or static electricity may cause it to lockup. In the unlikely event that this happens, unplug the power cord from the wall outlet, wait at least five seconds, and then plug it back in again.

Onkyo is not responsible for damages (such as CD rental fees) due to unsuccessful recordings caused by the unit's malfunction. Before you record important data, make sure that the material will be recorded correctly.

Before disconnecting the power cord from the wall outlet, set the AV receiver to Standby.

Memory Backup

The AV receiver uses a battery-less memory backup system in order to retain radio presets and other settings when it's unplugged or in the case of a power failure. Although no batteries are required, the AV receiver must be plugged into an AC outlet in order to charge the backup system. Once it has been charged, the AV receiver will retain the settings for several weeks, although this depends on the environment and will be shorter in humid climates.

The following settings can be made for the S-Video and composite video inputs

You must use the buttons on the unit to make these settings.

1. While holding down the input selector button for the input source that you want to set, press the [SETUP] button.
2. Use the Up and Down [▲]/[▼] buttons to select a setting (see below).
3. Use the Left and Right [◀]/[▶] buttons to change the setting:
4. Press the [SETUP] button when you've finished.

• Video Attenuation

This setting can be made for the DVD, VIDEO 1, VIDEO 2, or VIDEO 3 input.

If you have a games console connected to an S-Video or composite video input, and the picture isn't very clear, you can attenuate the gain.

Video ATT:0: (default).

Video ATT:2: Gain is reduced by 2 dB.

• Outputting S-Video Sources from the Composite Video Outputs

This setting can be made for the DVD, VIDEO 1, or VIDEO 2 input.

With this setting, you can output S-Video input sources from the composite video outputs, useful if your TV doesn't have any S-Video inputs.

Y/C Mix:Off: S-Video input signals are output by only S-Video outputs (default).

Y/C Mix:On: S-Video input signals are output by S-Video outputs and composite video outputs.

Specifications

Amplifier Section

Rated Output Power (FTC) All channels:	110 watts minimum continuous power per channel, 8 ohm loads, 2 channels driven at 1 kHz, with a maximum total harmonic distortion of 0.9%
Rated Output Power (IEC)	7 ch × 130 W at 8 ohms, 1 kHz, 1 ch driven
Maximum Output Power (JEITA)	7 ch × 160 W at 8 ohms, 1 kHz, 1 ch driven
Dynamic Power	230 W + 230 W (3Ω, Front) 170 W + 170 W (4Ω, Front) 120 W + 120 W (8Ω, Front)
THD (Total Harmonic Distortion)	0.08% (Power Rated)
Damping Factor	60 (Front, 1kHz, 8Ω)
Input Sensitivity and Impedance	200 mV/ 47 kΩ (LINE)
Output Level and Impedance	200 mV/ 470 Ω (REC OUT)
Frequency Response	5 Hz–100 kHz/ +1 dB–3 dB (Direct mode)
Tone Control	±10 dB, 80 Hz (BASS) ±10 dB, 20 kHz (TREBLE)
Signal to Noise Ratio	100 dB (LINE, IHF-A)
Speaker Impedance	8Ω–16Ω

Video Section

Input Sensitivity/Output Level and Impedance	1 Vp-p /75Ω (Component and S-Video Y) 0.7 Vp-p /75Ω (Component Pb/Cb, Pr/Cr) 0.28 Vp-p /75Ω (S-Video C) 1 Vp-p /75Ω (Composite)
Component Video Frequency Response	5 Hz–50 MHz

Tuner Section

■ FM

Tuning Frequency Range	North American: 87.5 MHz–107.9 MHz Other: 87.5 MHz–108.0 MHz
Usable Sensitivity	Stereo: 22.2 dBf (75Ω IHF) Mono: 15.2 dBf (75Ω IHF)
Signal to Noise Ratio	Stereo: 67 dB (IHF-A) Mono: 73 dB (IHF-A)
THD	Stereo: 0.5% (1 kHz) Mono: 0.3% (1 kHz)
Frequency Response	30 Hz–15 kHz / ±1 dB
Stereo Separation	40 dB (1 kHz)

■ AM

Tuning Frequency Range	North American: 530 kHz–1710 kHz Others: 522/530 kHz–1611/1710 kHz
Usable Sensitivity	300 μV
Signal to Noise Ratio	40 dB
THD	0.7%

General

Power Supply	North American: AC 120 V, 60 Hz Others: AC 230–240 V, 50Hz
Power Consumption	North American: 5.9 A Others: 670 W
Standby Power Consumption	North American: 0.1 W Others: 0.5 W
Dimensions (W × H × D)	435 × 151 × 377 mm 17-1/8" × 5-15/16" × 14-13/16"
Weight	North American: 9.6 kg 21.2 lbs. Others: 10.2 kg 22.5 lbs.

■ Video Inputs

Component	DVD, VIDEO1, VIDEO2
S-Video	DVD, VIDEO1, VIDEO2
Composite	DVD, VIDEO1, VIDEO2, VIDEO3

■ Video Outputs

Component	MONITOR
S-Video	MONITOR, VIDEO1
Composite	MONITOR, VIDEO1

■ Audio Inputs

Digital Inputs	Optical: 3 Coaxial: 1
Analog Inputs	DVD (MULTICHANNEL), VIDEO1, VIDEO2, VIDEO3, TAPE, CD
Multichannel Inputs	7.1

■ Audio Outputs

Analog Outputs	TAPE, VIDEO1
Subwoofer Pre Outputs	1
Speaker Outputs	SP A (L, R, C, SL, SR, SBL, SBR) SP B (L, R)
Phones	1

■ Speaker

■ Powered Subwoofer (SKW-540)

Type:	Bass-reflex
Input	
sensitivity/impedance:	330 mV / 100 kΩ
Maximum output power:	230 W (Dynamic Power)
Frequency response:	25 Hz–150 Hz
Cabinet capacity:	1.36 cubic feet (38.5 L)
Dimensions	
(W × H × D):	10-13/16" × 18-5/8" × 17-11/16" (275 × 473 × 449 mm)
Weight:	25.4 lbs. (11.5 kg)
Drivers unit:	10 inch (25 cm) Cone Woofer
Power supply:	North American: AC 120 V, 60 Hz Australian: AC 230-240 V, 50 Hz
Power consumption:	North American: 140 W Australian: 137 W
Other:	Auto Standby function

■ Front Speaker (SKF-540F)

Type:	2 Way Bass-reflex
Impedance:	8 Ω
Maximum input power:	130 W
Output sound pressure level:	86 dB/W/m
Frequency response:	55 Hz–50 kHz
Crossover frequency:	4.5 kHz
Cabinet capacity:	0.28 cubic feet (8.0 L)
Dimensions	
(W × H × D):	6-3/16" × 17-1/16" × 7-7/8" (157 × 433 × 200 mm)
Weight:	8.4 lbs. (3.8 kg)
Drivers unit:	5 inch (12 cm) OMF Cone Woofer × 2 1 inch (2.5 cm) Balanced Dome Tweeter
Terminal:	Color-coded push type
Other:	Magnetic shielding

■ Center Speaker (SKC-540C)

Type:	2 Way Bass-reflex
Impedance:	8 Ω
Maximum input power:	130 W
Output sound pressure level:	86 dB/W/m
Frequency response:	55 Hz–50 kHz
Crossover frequency:	4.5 kHz
Cabinet capacity:	0.28 cubic feet (8.0 L)
Dimensions	
(W × H × D):	17-1/16" × 6-3/16" × 7-7/8" (433 × 157 × 200 mm)
Weight:	8.4 lbs. (3.8 kg)
Speaker:	5 inch (12 cm) OMF Cone Woofer × 2 1 inch (2.5 cm) Balanced Dome Tweeter
Terminal:	Color-coded push type
Other:	Magnetic shielding

■ Surround Speaker (SKM-540S/SKB-540)

Type:	2 Way Bass Reflex
Impedance:	8 Ω
Maximum input power:	130 W
Output sound pressure level:	82 dB/W/m
Frequency response:	60 Hz–20 kHz
Crossover frequency:	10 kHz
Cabinet capacity:	0.07 cubic feet (2.1 L)
Dimensions	
(W × H × D):	6-7/8" × 10-7/16" × 4" (175 × 265 × 102 mm)
Weight:	3.1 lbs. (1.4 kg)
Speaker:	3-1/8 inch (8 cm) Cone Woofer 3/4 inch (2 cm) Ceramic Tweeter
Terminal:	Color-coded push type

Specifications and appearance are subject to change without prior notice.

Memo

ONKYO CORPORATION

Sales & Product Planning Div. : 2-1, Nisshin-cho, Neyagawa-shi, OSAKA 572-8540, JAPAN
Tel: 072-831-8023 Fax: 072-831-8124

ONKYO U.S.A. CORPORATION

18 Park Way, Upper Saddle River, N.J. 07458, U.S.A.
Tel: 201-785-2600 Fax: 201-785-2650 <http://www.us.onkyo.com/>

ONKYO EUROPE ELECTRONICS GmbH

Liegnitzerstrasse 6, 82194 Groebenzell, GERMANY
Tel: +49-8142-4401-0 Fax: +49-8142-4401-555 <http://www.eu.onkyo.com/>

ONKYO EUROPE UK Office

Suite 1, Gregories Court, Gregories Road, Beaconsfield, Buckinghamshire, HP9 1HQ
UNITED KINGDOM Tel: +44-(0)1494-681515 Fax: +44(0)-1494-680452

ONKYO CHINA LIMITED

Units 2102-2107, Metroplaza Tower I, 223 Hing Fong Road, Kwai Chung,
N.T., HONG KONG Tel: 852-2429-3118 Fax: 852-2428-9039
<http://www.ch.onkyo.com/>



I0602-1

SN 29344189

(C) Copyright 2006 ONKYO CORPORATION Japan. All rights reserved.



Remote Control Codes

1. While holding down the **REMOTE MODE** button that you want to set, press the **[DISPLAY]** button for 3 seconds.
2. Use the number buttons to enter the 4-digit remote control code.

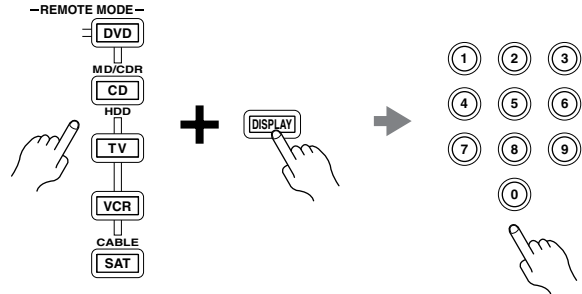

Codes de télécommande

1. Maintenez le bouton **REMOTE MODE** à initialiser enfoncé et appuyez sur le bouton **[DISPLAY]** durant 3 secondes.
2. Entrez les 4 chiffres du code de télécommande avec les boutons numériques.

Codici del telecomando

1. Mentre tenete premuto il pulsante **REMOTE MODE** che volete impostare, premete il pulsante **[DISPLAY]** per 3 secondi.
2. Utilizzate i pulsanti numerici per inserire il codice di telecomando a 4 cifre.

Afstandsbedieningscodes

1. Houd de **REMOTE MODE** toets ingedrukt die u wilt instellen en druk dan de **[DISPLAY]** toets 3 seconden in.
2. Met de cijfertoetsen de 4-cijferige afstandsbedieningscode in.

遙控代碼

1. 按下您希望設置的遙控鍵，同時按下 **[DISPLAY]** 鍵保持 3 秒鐘。
2. 使用數字鍵輸入 4 位數字的遙控代碼。

Códigos de control remoto

1. Manteniendo pulsado el botón **REMOTE MODE** que desee ajustar, pulse el botón **[DISPLAY]** durante 3 segundos.
2. Utilice los botones de número para introducir el código de 4 dígitos para control remoto.

Fernbedienungscodes

1. Halten Sie die änderungsbedürftige **REMOTE MODE**-Taste gedrückt, während Sie die **[DISPLAY]**-Taste 3 Sekunden lang betätigen.
2. Geben Sie mit den Zifferntasten den 4-stelligen Fernbedienungscodes ein.

Fjärrstyrningskoder

1. Tryck in och håll lämplig lägesväljare (**REMOTE MODE**) intryckt och tryck samtidigt in knappen **[DISPLAY]** i tre sekunder.
2. In den 4-siffriga fjärrstyrningskoden med hjälp av sifferknapparna.

遙控代碼

1. 按下您希望設置的遙控鍵，同時按下 **[DISPLAY]** 鍵保持 3 秒鐘。
2. 使用數字鍵輸入 4 位數字的遙控代碼。

DVD Player

Acoustic Solutions	0730, 0713
Advent	1016
Aiwa	0641
Akai	0899, 1115
Akura	0898
Amoisonic	0835
Amphion Media Works	0872
Amstrad	0713
AMW	0872
Apex Digital	0755, 0794, 0830, 1020, 1061
Aspire Digital	1168
Audiovox	1071, 1121, 1122
Axion	1071, 1193
Blue Nova International	1321
Broksonic	1419
Bush	0516, 0690, 0713
Cambridge Soundworks	0690
Celestial	1020
Changhong	0627, 1061
CineVision	0833, 1483
Clayton	0713
Coby	0852, 1086, 1321, 1351
Conia	0835
CyberHome	0714, 0874, 1023, 1129
Daewoo	0714, 0833
Daytek	0872
Denver	0898, 1321
Diamond	0768
Dick Smith Electronics	0833, 1483
Digitor	0690
Disney	0675
DSE	0833, 1483
DVD2000	0521
ECC	0730
Elta	1115
Eltax	1321
Emerson	0675, 0821, 1268
Ferguson	0898
Funai	0675, 1268, 1334
Gateway	1073
GE	0815
Go Video	0715, 0833, 1044, 1075, 1099, 1304, 1483
Go Vision	1071
H & B	0818, 0841, 1233, 1421
Harman/Kardon	0582
Hitachi	1247, 1664
iLo	1348
Integra	0627
Jensen	1016
JVC	0558
jWin	1051
Kiss	0841, 1523
KLH	1020, 1261

DVD Player

Kreisen	1421
KXD	1321
Lecson	1533
Lenoxx	0838
LG	0801
Limit	0768
LiteOn	1058, 1416, 1440
Loewe	0511
Lumatron	1321
Magnavox	0675, 0821, 1140, 1268
McIntosh	1533
Medion	1347
Memorex	0690
Metronic	0690
Mitsubishi	1521, 0521, 1403
Mustek	0730
NEC	0785, 1404
Nintaus	1051
Norcent	1003, 0872
Onkyo	0627, 1612(RI)
Orion	1419
Palsonic	0835, 0852
Panasonic	0703, 1010, 1011, 1362, 1462, 1490, 1762
Philco	0690
Philips	0675, 0854, 1260, 1340, 1354
Pioneer	0525, 0631
Polaroid	1020, 1061, 1086
Prima	1016
ProVision	1321
RCA	0822, 1022, 1132, 1193
Redstar	0898
Relisys	1347
Roadstar	1051
Sampo	1321
Samsung	0820, 0899, 1044, 1075
Santosh	1115
Sanyo	0873
Sharp	0675, 1256, 1419
Skyworth	0898
Sliding	1115
SM Electronic	0730, 0690
Sonic Blue	1099
Sony	1533, 1033, 1069, 1070, 1431
Sova	1122
Superscan	0821
Sylvania	0675, 0821, 1268
Symphonic	0675, 1268
Tangent	1321
Teac	0516, 0759, 0809, 0833, 1006, 1021, 1483
Technics	0703
Technosonic	0730
Tedelex	0690
Tevion	1036, 1227, 1382

DVD Player

Thomson	0551
Toshiba	1045, 1154, 1510
TRANS-continent	1321
Umax	0690
Vizio	1064
Yamada	0872, 1416
Yamaha	0545
Yamakawa	0872

DVD Recorder

Aspire Digital	1168
Coby	1086
CyberHome	1129
Eltax	1321
Funai	0675, 1334
Gateway	1073
Go Video	1304
H & B	1421
Hitachi	1664
iLo	1348
Kreisen	1421
LiteOn	1416, 1440
Medion	1347
Mitsubishi	1403
NEC	1404
Panasonic	1010, 1011
Pioneer	0631
Polaroid	1086
Relisys	1347
Sharp	0675, 1419
Sony	1033, 1069, 1070, 1431
Sylvania	0675
Tangent	1321
Tevion	1227
Thomson	0551
Toshiba	1510
Yamada	1416

TV/DVD Combination

Advent	1016
Apex Digital	0830
Audiovox	1071, 1121, 1122
Axion	1071, 1193
Bush	0516, 0713
Emerson	0675, 1268
Go Vision	1071
Hitachi	1247
Jensen	1016
KLH	1261
Magnavox	1268
Panasonic	1490
Philips	0854, 1260
Prima	1016
RCA	1022, 1193
Samsung	0899
Sliding	1115
Sova	1122
Sylvania	0675, 1268
Teac	1021



CD Player

Anthem	0897
Bush	0388
Carver	0179
Classic	1297
Copland	0393
Denon	0034, 0766
Dynamic Bass	0179
Fisher	0179, 1325
Garrard	0393
Genexxa	0426
GoldStar	1208
GPX	1296
Harman/Kardon	0173, 0426, 1202
HHB	0192
Inkel	0180
JVC	1294
Kenwood	0826, 0028, 0037
KLH	1373
LG	1208
Magnavox	0038
Marantz	0038, 0180, 0435
Memorex	0180
Musical Fidelity	0393
NAD	0721, 1208
Onkyo	1327(RI), 1817
Optimus	1063, 0037, 0468, 0087, 0179, 0426
Panasonic	0388, 0752
Philips	0274
Pioneer	1063, 1062, 1087, 0468, 0192
RCA	1062, 0468, 0053, 0179
Realistic	0179, 0180
Roksan	0435
Rotel	0897
Sanyo	0087, 0179
Sharp	0861, 0037, 0034, 0180
Sherwood	1067, 0180, 0426
Silsonic	0888
Sony	0100, 1364, 0185
TDK	1208
Teac	0393, 0180, 0435
Technics	0207, 1078
Thomson	0053
Universum	0053
Wards	0053
Yamaha	0888, 1292

CD Recorder

Classic	1297
Denon	0766
Fisher	1325
GPX	1296
Harman/Kardon	1202
HHB	0192
JVC	1294
KLH	1373
LG	1208
NAD	1208
Onkyo	1322(RI), 1323
Pioneer	1062, 1087, 0192
RCA	0053
Sony	0100, 1364
TDK	1208
Yamaha	0888, 1292

MD Recorder

Kenwood	0826
Onkyo	0868, 1808(RI)
Optimus	1063
Pioneer	1063
Sharp	0861
Sherwood	1067
Sony	0185
Technics	1078
Yamaha	0888

HDD Player

Onkyo	1990, 1993(RI)
-------	----------------

TV	
888	0264
Acura	0009
Addison	0653, 0108, 0092, 1150
Admiral	0463, 0163
Advent	0761, 0783, 0815, 0842
Aiko	0092
Aiwa	0701, 1180
Akai	0060, 0812, 0702, 0030, 0264, 0218, 0009, 0208, 0672, 0729, 0745, 0753, 1207
Akura	0264, 0218
Alba	0037, 0218, 0009, 0371
Albatron	0700
Alfide	0672
America Action	0180
Amstrad	0171, 0037, 0009, 0371
Anam	0250, 0180, 0009, 0161, 0700
Anam National	0250, 0161
Anhua	0051
Anitech	0009
AOC	0451, 0180, 0060, 0030, 0108, 0009, 0092, 1150
Aolinpike	0264
Apex Digital	0156, 0748, 0765, 0767, 0879, 1217
Asuka	0218
Audinac	0180
Audiosonic	0037, 0109
Audiovox	0451, 0180, 0092, 0623, 0802
Aventura	0171
Awa	0009
Baihe	0264, 0009
Baile	0001, 0009, 0374, 0661
Baird	0343
Bang & Olufsen	0565
Baohuashi	0264
Baosheng	0009
Basic Line	0218, 0009
Baur	0037, 0512
Baysonic	0180
Beijing	0812, 0264, 0226, 0001, 0009, 0208, 0374, 0661
Beko	0714, 0370
Bell & Howell	0154
BenQ	1032
Beon	0037
Blaupunkt	0195
Blue Sky	0556, 0218, 1254
BPL	0896
Bradford	0180

TV	
Brandt	0109, 0335
Broksonic	0236, 0463, 0180
BTC	0218
Bush	0037, 0698, 0218, 0009, 0371, 0374
Caihong	0009
Cailing	0748
Candle	0030, 0056
Carnivale	0030
Carver	0054, 0170
Cascade	0009
Cathay	0037
CCE	0037
Celebrity	0000
Celera	0765
Celestial	0767
Centrex	0780
Centurion	0037
Changcheng	0051, 0264, 0001, 0009, 0374, 0661
Changfei	0009, 0374
Changfeng	0264, 0753
Changhai	0009
Changhong	0156, 0765, 0264, 0508, 0009, 0767, 0783, 1156
Chengdu	0009
Ching Tai	0009, 0092
Chun Yun	0000, 0180, 0009, 0092, 0161, 0700, 1150
Chunfeng	0264, 0009
Chung Hsin	0180, 0053, 0108, 1150
Chunsun	0009
Cimline	0009
Cinema	0672
Cineral	0451, 0092
Citizen	0060, 0030, 0056, 0092
Clarion	0180
Clarivox	0037
Clatronic	0370
Commercial Solutions	0047, 1447
Concerto	0056
Condor	0370
Conrowa	0156, 0145, 0698, 0264, 0009, 0753, 1156
Contec	0180, 0009
Craig	0180, 0161
Crosley	0054
Crown	0180, 0037, 0370, 0009, 0418, 0672
Crown Mustang	0672
Curtis Mathes	0047, 0054, 0154, 0451, 0060, 0702, 0030, 0145, 0166, 0056, 1147, 1347
CXC	0180

TV	
Cybertron	0218
Daewoo	0154, 0451, 0180, 0030, 0037, 0634, 0108, 1150, 0880, 0700, 0672, 0661, 0623, 0374, 0170, 0092, 0056, 0009
Dainichi	0218
Dansai	0037
Dayton	0009
Dayu	0374, 0661
De Graaf	0548, 0208
Decca	0037
Dell	1454, 1080
Denon	0145, 0511
Dick Smith Electronics	0698
Digatron	0037
Digital Life	0780
Digitor	0037, 0698
Digix	0880
Dixi	0037, 0009
Dongda	0009
Donghai	0009
DSE	0698
Dumont	0017
Durabrand	0463, 0180, 0171
ECE	0037
Electroband	0000
Elektra	0017
Elin	0037, 0548
Elite	0218
Elta	0009
Emerson	0154, 0451, 0236, 0463, 0180, 0171, 0623
Envision	0030
Erres	0037
ESA	0812, 0171
Ether	0030, 0009, 0161
Etron	0009
Feilang	0009
Feilu	0009
Feiyan	0264
Feiyue	0009
Ferguson	0037, 0560, 0109, 0335, 0343
Finlandia	0208, 0346
Finlux	0037, 0105, 0346
Firstar	0236, 0009
Firstline	0009
Fisher	0154, 0370, 0208
Formenti	0037
Frontech	0264, 0163
Fujitsu	0809, 1181
Funai	0180, 0171, 0264, 0342
Furi	0145, 0264
Futuretech	0180

TV	
GE	0047, 0051, 0451, 0180, 0030, 1447, 1454, 0560, 0092, 1147, 1347
GEC	0037
Geloso	0009
Genexxa	0218, 0163
Gibraltar	0017, 0030
Gintai	1150
Go Video	0886
GoldStar	0154, 0030, 0037, 0001, 0056, 0109, 1150, 1378
Goodmans	0037, 0634, 0343, 0360, 0371, 0374
Gorenje	0370
GPM	0218
Gradiente	0053, 0056, 0170
Graetz	0714, 0163
Granada	0037, 0208
Grandin	0610, 0880
Grundig	0556, 0037, 0195, 0487, 0672
Grunpy	0180
Haier	0037, 0698, 0508, 0896
Haihong	0009
Haiyan	0264
Hankook	0180, 0030, 0056
Hanseatic	0556, 0037, 0661
Harman/Kardon	0054
Harvard	0180
Harwa	0773
HCM	0009
Hello Kitty	0451
Himitsu	0180
Hinari	0037, 0218, 0009
Hisense	0156, 0748, 0145, 0556, 0508, 0009, 0753, 0780, 1156
Hitachi	0156, 0030, 1145, 0145, 1256, 0548, 0225, 0508, 1378, 1245, 1156, 1150, 1149, 0744, 0578, 0577, 0481, 0163, 0109, 0105, 0092, 0056, 0009
Hongmei	0264, 0009
Hongyan	0264
Hua Tun	0009, 1150
Huafa	0145, 0009
Huanghaimei	0009
Huanghe	0009
Huanglong	0009
Huangshan	0264, 0009
Huanyu	0264, 0374
Huaqiang	0264
Huari	0145, 0264
Huodateji	0051
Hypson	0037, 0264
ICE	0264, 0371

TV	
ICeS	0218
Imperial	0370, 0418
Imperial Crown	0264, 0001, 0009, 0374, 0661
Indiana	0037
Infinity	0054
Ingelen	0163
Innova	0037
Inteq	0017
Interfunk	0037, 0163, 0512
Intervision	0037, 0264
IRT	0451, 0698
Isukai	0218
ITS	0371
ITT	0548, 0163
IX	0877
JBL	0054
JCB	0000
Jean	0156, 0051, 0236, 0009, 0092
Jensen	0761, 0815
Jiahua	0051
JiaLiCai	0264, 0009
Jinfeng	0051, 0226, 0208
Jinque	0264, 0009
Jinta	0264, 0009
Jinxing	0054, 0156, 0145, 0556, 0037, 0698, 0264, 0009
Juhua	0264
JVC	0463, 0053, 0606, 0653, 0508, 0160, 0371, 1172, 1253
Kaige	0264, 0009
Kaisui	0218, 0009
Kanghua	0896
Kangli	0264, 0001, 0009, 0374, 0661
Kangyi	0264, 0009
Kapsch	0163
Karcher	0610
Kathrein	0556
KEC	0180
Kendo	0037
Kenwood	0030
Kioto	0054, 0556
KLH	0765, 0767
KLL	0037
Kolin	0180, 0150, 0053, 0108, 1150
Kongque	0264, 0009
Konka	0037
Korpel	0037
Koyoda	0009
KTV	0180, 0030
Kuaille	0264, 0009
Kulun	0009
Kunlun	0051, 0264, 0226, 0208, 0374, 0661
Leyco	0037, 0264

TV	
LG	1265, 0060, 0030, 0037, 0714, 0108, 0001, 0056, 0442, 0644, 0700, 0856, 1148, 1378
Liesenk & Tter	0037
Local India TV	0264, 0371
Loewe	0136, 0512, 0633, 0790
Logik	0001, 1217
Longjiang	0264
Luxman	0056
LXI	0047, 0054, 0154, 0156
M & S	0054
M Electronic	0037, 0009, 0105, 0109, 0163, 0346, 0374, 0480
Magnavox	0054, 0030, 1454, 0780, 0802, 1254
Manesth	0264
Marantz	0054, 0030, 1454, 0556, 0037, 0855
Mark	0037
Matsui	0037, 0487, 0009, 0035, 0208, 0371
Matsushita	0250, 0161
Mediator	0037
Medion	0880, 1248
Megapower	0700
Megatron	0145
Meile	0264
Memorex	0154, 0463, 0150, 0009
Mercury	0001
Mermaid	0037
Metronic	0625
MGA	0150, 0030
Midland	0047, 0017, 0051
Minerva	0487
Mitsubishi	0154, 0250, 0236, 0180, 0150, 1250, 0030, 0108, 0056, 0512, 0836, 1150, 1171, 1182
Monivision	0700
MTC	0060, 0030, 0056, 0512
Mudan	0051, 0264, 0226, 0009, 0208
Multitech	0180, 0009
Myryad	0556
NAD	0156, 0866
Nanbao	0264, 0009
Nansheng	0264
National	0051, 0226, 0508, 0208

TV	
NEC	0154, 0156, 0051, 0053, 0030, 0264, 0508, 0009, 0056, 0170, 1150, 1182, 1378, 1456
Neckermann	0556, 0037
NEI	0037
Netsat	0037
Newave	0009, 0092, 0161, 1150
Nikkai	0037, 0264, 0218, 0035
Nikko	0030, 0092
Noblex	0154
Nokia	0548, 0606, 0480, 0631
Norcent	0748, 0824
Nordmende	0560, 0109, 0343
NTC	0092
Oceanic	0163
Onwa	0180
Optimus	0154, 0250, 0166
Orion	0236, 0463, 0037, 0880, 1463
Osaki	0264, 0218
Oso	0218
Otto Versand	0556, 0037, 0343, 0512
Palladium	0370, 0418
Palsonic	0773
Panama	0264
Panasonic	0054, 0250, 0051, 0037, 0226, 0508, 0161, 0163, 0208, 0896, 1168, 1175, 1177, 1210
Panda	0051, 0698, 0264, 0226, 0508, 0009, 0208, 0780
Pausa	0009
Penney	0047, 0156, 0051, 0060, 0030, 1347, 1378
Philco	0054, 0463, 0180, 0030, 0145, 0037, 0056
Philips	0054, 0000, 0051, 0030, 1454, 0556, 0037, 0108, 0056, 0092, 0374, 0512, 0690, 1455
Phonola	0037
Pilot	0030
Pioneer	0166, 0109, 0163, 0760, 0866, 1260
Polaroid	0765
Portland	0092
Prima	0761, 0783, 0815
Princeton	0700
Prism	0051
Profex	0009
Proscan	0047, 1447, 1347

TV	
Protech	0037, 0264, 0009, 0418
Proton	0030, 0001, 0009, 0056, 0644
Pulsar	0017
Pye	0037
Qingdao	0051, 0264, 0226, 0208
Quasar	0250, 0051
Quelle	0037, 0512
R-Line	0037
Radiola	0037
RadioShack	0047, 0154, 0180, 0030, 0056
RCA	0047, 0000, 0060, 0030, 1447, 1454, 0618, 0090, 0092, 1047, 1147, 1247, 1347, 1547
Realistic	0154, 0180, 0030, 0056
Relisys	0877, 1207
Reoc	0714
Revox	0037
Rex	0264, 0163
Roadstar	0264, 0218, 0009, 0418
Rowa	0748, 0037, 0698, 0712, 0009
Runco	0017, 0030
Saba	0109, 0163, 0335, 0343
Sagem	0610
Saige	0009
Saisho	0264, 0009
Salora	0548, 0163
Sampo	0154, 0030, 0171, 0009, 0092, 0700
Samsung	0154, 0156, 0060, 0812, 0702, 0030, 0556, 0037, 0264, 0370, 0618, 0226, 1150, 1060, 0814, 0766, 0644, 0208, 0092, 0090, 0056, 0009
Sanjian	0264
Sansei	0451
Sansui	0463, 0729
Sanyo	0154, 0156, 0180, 0145, 0264, 0508, 0088, 0208, 0376, 0424, 0799, 1150, 1179
Sanyuan	0009
SBR	0037
Sceptre	1217
Schneider	0037, 0218, 0371, 0394
Scott	0236, 0180
Sears	0047, 0054, 0154, 0156, 0171, 0056
SEG	0264

TV	
Seleco	0163
Semivox	0180
Semp	0156, 1356
Sentra	0035
Shancha	0264
Shanghai	0264, 0226, 0009, 0208
Shaofeng	0145
Sharp	0030, 0009, 0256, 0787, 0818, 1165
Shen Ying	0009, 0092
Shencai	0145, 0264, 0009
Sheng Chia	0236, 0009, 1150
Shenyang	0264, 0009, 0753
Sherwood	0009
Siemens	0037, 0195
SKY	0037
Skygiant	0180
Skyworth	0748, 0037, 0698, 0264, 0009, 0753
Sliding	0880
Solavox	0163
Songba	0009
Sonitron	0208
Sonoko	0037, 0009
Sonolor	0163, 0208
Sontec	0037
Sony	1100, 0000, 1505, 0353, 0810, 1167, 1300, 1651
Soundesign	0180
Soundwave	0037, 0418
Sowa	0156, 0051, 0060, 0226, 0092, 1150
Squareview	0171
SSS	0180
Standard	0218, 0009
Starlite	0180
Stern	0163
Superscan	0864
Supra	0056
Supreme	0000
Susumu	0218
SVA	0748
Sylvania	0054, 0030, 0171
Symphonic	0180, 0171
Synco	0000, 0451, 0060, 0092
Sysline	0037
Tacico	0009, 0092, 1150
Tai Yi	0009, 1150
Taishan	0009, 0374
Tandy	0218, 0163
Tashiko	0092, 1150
Tatung	0054, 0154, 0156, 0051, 0060, 0037, 0009, 1150, 1156, 1254
TCL	0698

TV	
Teac	0037, 0698, 0712, 0264, 0009, 0418, 1149
Technics	0250, 0051
Technisson	0714
Techwood	0051, 0056
Teco	0051, 0264, 0218, 0653, 0009, 0092
Teknika	0054, 0180, 0150, 0060, 0056, 0092
Teleavia	0343
Telefunken	0702, 0625, 0056, 0109, 0335, 0343, 0896
Teletech	0009
Tensai	0218
Tera	0030, 0092
Tevion	0767
Texet	0218
Thompson	0625
Thomson	1447, 0625, 0560, 0109, 0343
Thorn	0037, 0035, 0343, 0512
Thorn-Ferguson	0343
Tiny	1269
TMK	0056
TNCi	0017
Tobo	0748, 0264, 0009
Tongguang	0264
Tongtel	0780
Tophouse	0180
Toshiba	0154, 0156, 1265, 0060, 0145, 1256, 0264, 0618, 0508, 1456, 1356, 1173, 1169, 1156, 1150, 0845, 0644, 0509, 0241, 0161, 0035, 0009
Transonic	0698, 0712
Tuntex	0030, 0009, 0092
TVS	0463
Universum	0037, 0264, 0370, 0105, 0346, 0492
Vector Research	0030
Vestel	0037
Victor	0250, 0053, 0653, 0160, 0376
Videocon	0508
Vidikron	0054
Viewsonic	0857, 0864, 0885
Viore	1207
Vizio	0864, 0885
Voxson	0163
Wards	0054, 0030, 0056, 0866, 1156
Warumaia	0374, 0661
Watson	0037
Waycon	0156
Weipai	0009
Westinghouse	0451, 0889

TV	
White Westinghouse	0463, 0037, 0623
Xenius	0661
Xiahua	0698, 0264, 0009, 0773
Xianghai	0009
Xiangyang	0264
Xiangyu	0009
Xihu	0264
Xingfu	0009
Xinghai	0264
Xoro	1217
Yamaha	0030
Yapshe	0250
Yingge	0009
Yoko	0037, 0264
Yonggu	0009
Yousida	0009
Yuhang	0009
Zenith	0017, 0463, 1145, 0092
ZhuHai	0009, 0374
Zonda	0698

VCR	
ABS	1972
Admiral	0209, 0479
Aiwa	0348, 0307, 0352, 0124, 0479, 1291
Akai	0041, 0315, 0175
Akiba	0072
Alba	0209, 0072, 0352, 0315
Alienware	1972
American High	0035
Amoisonic	0479
Anam	0162, 0226, 0480, 1037
Anam National	0162, 1562, 0226
Anitech	0072
Baird	0041
Basic Line	0072
Blaupunkt	0162, 0226
Brandt	0320
Brandt Electronique	0041
Broksonic	0184, 0121, 0209, 0002, 0348, 0479, 1479
Bush	0209, 0072, 0352
Canon	0035
CCE	0072
Cimline	0072
Citizen	1278
Colt	0072
Combitech	0352
Craig	0047, 0072
Crown	0072
Curtis Mathes	0060, 0035, 0162, 0041, 1035
CyberPower	1972
Daewoo	0637, 0642, 0046, 1278
Dansai	0072
Dell	1972
Dick Smith Electronics	0642
Digitor	0642
DirecTV	0739
DSE	0642
Dual	0041
Durabrand	0039
Elcatech	0072
Emerson	0035, 0184, 0121, 0209, 0002, 0637, 0348, 0479, 0593, 1278, 1479, 1593
Ferguson	0041, 0320
Firstline	0209, 0072
Fisher	0047, 0046
Fuji	0035, 0033
Funai	0593, 1593
Gateway	1972
GE	0060, 0035, 0226, 0807, 1035, 1060
Go Video	0432

VCR	
GoldHand	0072
GoldStar	0209, 0226, 0225, 0480, 1237
Goodmans	0072, 0637
Graetz	0041
Granada	0046
Grandin	0072
Grundig	0072, 0226
Harwood	0072
HCM	0072
Headquarter	0046
Hewlett Packard	1972
HI-Q	0047
Hinari	0072, 0352
Hitachi	0041, 0089, 1037
Howard Computers	1972
HP	1972
Hughes Network Systems	0739
Humax	0739
Hush	1972
Hypson	0072
iBUYPOWER	1972
ITT	0041, 0046
Jensen	0041
JVC	0041, 1162, 1279
Kaisui	0072
Kendo	0209
Kenwood	0041
Kioto	0348
KLH	0072
Kodak	0035
Kolin	0041
Korpel	0072
Leyco	0072
LG	0209, 0480, 1037
Linksys	1972
Loewe	0162, 1562
Logik	0072
Luxor	0046
Magnasonic	0593, 1278
Magnavox	0035, 0039, 0149, 0563, 0593, 1781
Manesth	0072
Marantz	0035
Matsui	0209, 0348, 0352
Matsushita	0035, 0162, 0226, 1162
Media Center PC	1972
Medion	0348
MEI	0035
Memorex	0035, 0162, 0039, 0047, 0209, 0348, 0307, 0046, 0479, 1037, 1162, 1237, 1262
Memphis	0072
Metz	0162, 1562
Microsoft	1972

VCR	
Mind	1972
Mitsubishi	0041, 0807, 1343
Motorola	0035
Multitech	0072
National	0226
NEC	0035, 0041, 1287
Nesco	0072
Niveus Media	1972
Nokia	0041, 0046
Nordmende	0041, 0320
Northgate	1972
Oceanic	0041
Okano	0348, 0315
Olympus	0035, 0226
Optimus	1062, 0162, 0432, 0593, 1162, 1262
Orion	0184, 0121, 0209, 0002, 0348, 0352, 0479, 1479
Osaki	0072
Palladium	0041, 0072
Panasonic	1062, 0035, 0162, 1562, 0226, 0225, 0616, 0836, 1035, 1162, 1244, 1262, 1293
Pathe Marconi	0041
Penney	0035, 1035, 1237
Philco	0035, 0209, 0226, 0479
Philips	0035, 0226, 0563, 0593, 0618, 0739, 1081, 1181, 1818
Proscan	0060, 1060
Protec	0072
Pulsar	0039
Qisheng	0060
Quarter	0046
Quartz	0046
Quasar	0035, 0162, 1035, 1162
RadioShack	1037
RCA	0060, 0035, 0149, 0226, 0807, 0880, 1035, 1060
Realistic	0035, 0047, 0046
Reoc	0348
ReplayTV	0614, 0616
Rex	0041
Ricavision	1972
Roadstar	0072
Runco	0039
Saba	0041, 0320
Saisho	0209
Salora	0046
Samsung	0432, 0739, 1014
Sanky	0039
Sansui	0209, 0041, 0479, 1479

VCR	
Sanyo	0047, 0046, 0159, 1330
Saville	0352
Schaub Lorenz	0041
Schneider	0072
Scott	0184, 0121
Sears	0035, 0047, 0046, 1237
Seleco	0041
Sharp	0209, 0807, 0848, 1285
Shintom	0072
Singer	0072
Sonic Blue	0614, 0616
Sonorol	0046
Sony	0035, 0033, 0636, 1032, 1232, 1295, 1296, 1447, 1448, 1636, 1972
Stack 9	1972
Sunkai	0348
Sylvania	0035, 0593, 1593, 1781
Symphonic	0593, 1593
Systemax	1972
Tagar Systems	1972
Tatung	0041
Teac	0041, 0637, 0307, 0642, 0593
Technics	0035, 0162, 0226
Teco	0035, 0041
Teknika	0035
Teleavia	0041
Telefunken	0041, 0320
Tenosal	0072
Thomson	0060, 0041, 0320
Thorn	0041
Tivo	0618, 0636, 0739, 1996
Toshiba	0209, 0041, 0828, 0845, 1008, 1145, 1290, 1972, 1996
Touch	1972
Victor	0041
Viewsonic	1972
Voodoo	1972
Wards	0060, 0035, 0047, 0072, 0149
Wharfedale	0593
White Westinghouse	0209, 0072, 0637
XR-1000	0035, 0072
Yamaha	0041
Yamishi	0072
Yokan	0072
Zenith	0039, 0033, 0209, 0637, 0479, 1139, 1479
ZT Group	1972

DBS/PVR Combination	
Hughes Network Systems	0739
Philips	0739
Samsung	0739
PVR	
ABS	1972
Alienware	1972
CyberPower	1972
Dell	1972
DirecTV	0739
Gateway	1972
Hewlett Packard	1972
Howard Computers	1972
HP	1972
Hughes Network Systems	0739
Humax	0739
Hush	1972
iBUYPOWER	1972
JVC	1279
Linksys	1972
Media Center PC	1972
Microsoft	1972
Mind	1972
Niveus Media	1972
Northgate	1972
Panasonic	0616, 1244
Philips	0618, 0739, 1818
RCA	0880
ReplayTV	0614, 0616
Sonic Blue	0614, 0616
Sony	0636, 1447, 1448, 1636, 1972
Stack 9	1972
Systemax	1972
Tagar Systems	1972
Tivo	0618, 0636, 0739
Toshiba	0828, 1008, 1972
Touch	1972
Viewsonic	1972
Voodoo	1972
ZT Group	1972

TV/VCR Combination	
Aiwa	0479
Broksonic	0002, 0479, 1479
Citizen	1278
Colt	0072
Curtis Mathes	1035
Daewoo	0637, 1278
Emerson	0002, 0637, 0479, 0593, 1278, 1479
GE	0807, 1035, 1060
GoldStar	1237
Goodmans	0637
LG	0480, 1037
Magnasonic	0593, 1278
Magnavox	0593, 1781
Memorex	0162, 1037, 1162, 1237, 1262
Mitsubishi	0807
Optimus	0162, 0593, 1162, 1262
Orion	0002, 0479, 1479
Panasonic	0162, 1035, 1162, 1262
Penney	1035, 1237
Philco	0479
Quasar	0162, 1035, 1162
RadioShack	1037
RCA	0807, 1035, 1060
Samsung	0432, 1014
Sansui	0479, 1479
Sanyo	1330
Sears	1237
Sharp	0807
Sony	1232, 1295, 1296
Sylvania	1781
Symphonic	0593
Teac	0637, 0593
Toshiba	0845, 1145
White Westinghouse	0637
Zenith	0637, 0479, 1479



Cable Converter

ABC	0003, 0008, 0033
Americast	0899
Amstrad	1222
Bell South	0899
British Telecom	0003
Cable & Wireless	1068
Clearmaster	0883
ClearMax	0883
Contec	0019
Coolmax	0883
Daeryung	0877, 1877, 0477, 0008
Digeo	1187
Director	0476
DX Antenna	1500
Filmnet	0443
France Telecom	1734
Fujitsu	1497
Funai	0019
Gehua	0476
General Instrument	0476, 0810, 0003
GoldStar	0144
Hamlin	0009, 0273
Hitachi	0033
Jerrold	0476, 0810, 0003, 0012
KNC	0008
LG	0144
Macom	0033
Memorex	0000
MNET	0019, 0443
Motorola	1376, 0476, 0810, 1187, 1483
Multichoice	0019, 0443
Multitech	0883
MultiVision	0012
NEC	1496
Noos	0817, 1624
NTL	1068, 1060, 0003
Oak	0019
Ono	1068
Pace	1877, 0237, 1068, 1060, 0008, 1577
Panasonic	0000, 0107, 0008, 1488
Paragon	0000
Philips	0317, 1305
Pioneer	0877, 1877, 0144, 0533, 1021, 1500
Pulsar	0000
PVP Stereo Visual Matrix	0003
Quasar	0000
RadioShack	0883
Regal	0279, 0273
Runco	0000
Sagem	0817
Samsung	0000, 0144, 1666
Scientific Atlanta	0877, 1877, 0477, 0008

Cable Converter

Sony	1006, 1460
Starcom	0003
Sumitomo	1500
Supermax	0883
Tele Danmark	1016
Tele+1	0443
Telewest	1068
Thomson	1734
Tocom	0012
Torx	0003
Toshiba	0000, 1509
Tristar	0883
TS	0003
United Cable	0003
V2	0883
Viewmaster	0883
Vision	0883
Vortex View	0883
Zenith	0000, 0525, 0899

Cable/PVR Combination

Americast	0899
Digeo	1187
France Telecom	1734
General Instrument	0476, 0810
Jerrold	0476, 0810
Motorola	1376, 0476, 0810, 1187
Noos	1624
Pace	1877, 0237
Pioneer	0877, 1877
Scientific Atlanta	0877, 1877
Sony	1006
Thomson	1734
Zenith	0899

Satellite Receiver

@sat	1300
@ Sky	1334
ADB	1259, 1367
Aiwa	1514
Alba	1284
AlphaStar	0772
Amstrad	0847, 0338
Ankaro	0713
Astro	0173
Atsat	1300
AtSky	1334
Austar	0642, 1259
Black Diamond	1284
Blaupunkt	0173
British Sky Broadcasting	0847, 1175
Bush	1284, 1672
Canal Digital	0853
Canal+	0853
CanalSatellite	0853, 1339, 1853
Chaparral	0216
CNS	1367
Comag	1412
Crossdigital	1109
Cyrus	0200
D-box	0873
Dgtec	1242, 1542
Digenius	0299
Digiturk	1076
DirecTV	1377, 0392, 0566, 0639, 1639, 1142, 0247, 0749, 1749, 0724, 0819, 1856, 1076, 1108, 1109, 1392, 1414, 1442, 1443, 1444, 1609, 1640
Dish Network System	1505, 1005, 0775, 1170, 1775
Dishpro	1505, 1005, 0775, 1775
DMT	1075
DNT	0200
Dream Multimedia	1237
DSTV	1433
DX Antenna	1530
Echostar	1505, 1005, 0775, 0853, 0610, 1200, 0713, 1170, 1775
Expressvu	0775, 1775
Ferguson	0711, 1291
Foxtel	0879, 1356
Funai	0338
GbSAT	1214
GE	0392, 0566
General Instrument	0869
GOI	0775, 1775
Gold Box	0853
Goodmans	1246, 1284
Gradiente	0887
Grundig	0847, 0173, 1291

Satellite Receiver

Hirschmann	0173
Hisense	1535
Hitachi	0819, 1250, 1284, 1525
HTS	0775, 1775
Hughes	0749, 1749, 1442
Hughes Network Systems	1142, 0749, 1749, 1442, 1443, 1444
Humax	1176, 1427, 1675
iLo	1535
Indovision	0887
ISkyB	0887
Jerrold	0869
JVC	0775, 0492, 1170, 1531, 1775
Kathrein	0173, 0200, 0442, 0480, 0504, 0622, 0658, 1416, 1567
Kreiselmeier	0173
LG	1226, 1414
Lorenzen	0299
Magnavox	0724, 0722
Marantz	0200
Maspro	1530
Matsui	1284
Maximum	1334
MediaSat	0853
Medion	1232, 1626
Memorex	0724
Metronic	0132, 0713, 1283, 1334
Mitsubishi	0749
Morgan's	0132
Motorola	0869
Multichoice	0879, 0642, 1433
Myryad	0200
NEC	1270, 1519
Netsat	0887
Next Level	0869
Nikko	0713
Nokia	0873, 1023, 1223, 1310
OctalTV	1505
Opentel	1232, 1412
Optex	1283
Orbitech	1100
Pace	0847, 0887, 0720, 1175, 0241, 0791, 1323, 1850
Panasat	0879
Panasonic	0247, 0701, 0847, 1304, 1404, 1526
Paysat	0724
Philips	1142, 0749, 1749, 0724, 0819, 1076, 0722, 0853, 0200, 1114, 0887, 0133, 0898, 1442, 1672
Pioneer	0853, 0329, 1308, 1442
Plasmatic	0442

Satellite Receiver

Preisner	0132, 0262
Proscan	0392, 0566
Proton	1535
QNS	1367, 1404
Radiola	0200
RadioShack	0869
RCA	0392, 0566, 0855, 0143, 1291, 1392
Rebox	1214
Sagem	0820, 1114, 1690
Samsung	1377, 1142, 1276, 1108, 1109, 1442, 1458, 1570, 1609
Sanyo	1219
Sat Control	1300
Schwaiger	0504
SEG	1626
Sharp	1517
Siemens	0173
SKY	1856, 0847, 0887, 1175, 1848, 1850
Skymaster	0713, 1409
Skyplus	1334, 1412
SM Electronic	1200, 0713, 1409
Smart	0132
Sony	0639, 1639, 0847, 1524, 1558, 1640
Star	0887
Star Choice	0869
Strong	0879, 0132, 1146, 1300, 1409, 1626
Supernova	0887
Teac	1227
TechniSat	0262, 1099, 1100
Technomate	1610
Technotrend	1429
Techwood	1284
Telestar	1100, 1334
Televisa	0887
Tevion	1409
Thomson	0853, 0711, 1046, 1291, 1534, 1900
Tiny	1672
Tivo	1142, 1442, 1443, 1444
Topfield	1206, 1208, 1545
Toshiba	0749, 1749, 0790, 0819, 1285, 1516, 1530
TPS	0820
UEC	0879
UltimateTV	1392, 1640
Uniden	0724, 0722, 1521
Universum	0173
US Digital	1535
USDTV	1535
Ventana	0200
Victor	0492
Voom	0869
Wisi	0173
Xsat	1323

Satellite Receiver

Yes	0887
Zehnder	1075, 1232, 1334, 1412
Zenith	1856

DBS/PVR Combination

@sat	1300
Atsat	1300
British Sky Broadcasting	1175
CanalSatellite	1339
Comag	1412
Digiturk	1076
DirecTV	1377, 0392, 0639, 1142, 1076, 1392, 1442, 1443, 1444, 1640
Dish Network System	1505, 0775
Dishpro	1505, 0775
Dream Multimedia	1237
Echostar	1505, 0775, 0610, 1170
Expressvu	0775
Foxtel	1356
GbSAT	1214
Hughes Network Systems	1142, 1442, 1443, 1444
Humax	1176, 1427, 1675
JVC	1170
Maximum	1334
Motorola	0869
Nokia	1310
Opentel	1412
Philips	1142, 1442
Proscan	0392
RCA	1392
Rebox	1214
Samsung	1442
SKY	1175, 1848, 1850
Skyplus	1412
Sony	0639, 1640
Star Choice	0869
Strong	1300
Thomson	1534, 1900
Topfield	1206, 1545
Zehnder	1075, 1412

ONKYO CORPORATION

Sales & Product Planning Div. : 2-1, Nisshin-cho, Neyagawa-shi, OSAKA 572-8540, JAPAN
Tel: 072-831-8023 Fax: 072-831-8124

ONKYO U.S.A. CORPORATION

18 Park Way, Upper Saddle River, N.J. 07458, U.S.A.
Tel: 201-785-2600 Fax: 201-785-2650 <http://www.us.onkyo.com/>

ONKYO EUROPE ELECTRONICS GmbH

Liegnitzerstrasse 6, 82194 Groebenzell, GERMANY
Tel: +49-8142-4401-0 Fax: +49-8142-4401-555 <http://www.eu.onkyo.com/>

ONKYO EUROPE UK Office

Suite 1, Gregories Court, Gregories Road, Beaconsfield, Buckinghamshire, HP9 1HQ
UNITED KINGDOM Tel: +44-(0)1494-681515 Fax: +44(0)-1494-680452

ONKYO CHINA LIMITED

Units 2102-2107, Metroplaza Tower I, 223 Hing Fong Road, Kwai Chung,
N.T., HONG KONG Tel: 852-2429-3118 Fax: 852-2428-9039
<http://www.ch.onkyo.com/>



I0603-2

647

SN 29344188A

(C) Copyright 2006 ONKYO CORPORATION Japan. All rights reserved.

